



Brad Nailers

Owners Manual for models EBN125, EBN200



Record All Information and attach sales receipt here for future reference:

Purchase Date: _____

Serial #: _____

Do Not return this product to the retailer!
Questions? 1-800-888-2468

Learn more about your tool, get answers to frequently asked questions, and register on line at www.devap.com

IMPORTANT

Please make certain that the person who is to use this equipment carefully reads and understands these instructions before starting operations.

ESPAÑOL: PÁGINA 13
FRANÇAISE : PAGE 25

TABLE OF CONTENTS

SAFETY GUIDELINES AND INSTRUCTIONS3
GENERAL SAFETY RULES	4-6
FUNCTIONAL DESCRIPTION7
PREPARING THE TOOL8
OPERATING INSTRUCTIONS	9-10
MAINTENANCE10
SERVICE11
TROUBLESHOOTING11
WARRANTY / SERVICE INFORMATION12
ESPAÑOL13-24
FRANÇAISE25-36

**DeVILBISS AIR POWER COMPANY**
213 Industrial Drive • Jackson, TN 38301-9615
Telephone: 1-800-888-2468
FAX: 1-800-888-9036

Date of Manufacture: _____
Fecha de fabricación:, Date de fabrication:
Serial No: _____
Número de serie:, Nombre d'ordre

SAFETY GUIDELINES / DEFINITIONS

It is important for you to read and understand this manual. The information it contains relates to protecting YOUR SAFETY and PREVENTING PROBLEMS. The symbols below are used to help you recognize this information.

▲ DANGER indicates an imminently hazardous situation which, if not avoided, will result in death or serious injury.

▲ WARNING indicates a potentially hazardous situation which, if not avoided, could result in death or serious injury.

▲ CAUTION indicates a potentially hazardous situation which, if not avoided, may result in minor or moderate injury.

CAUTION used without the safety alert symbol indicates potentially hazardous situation which, if not avoided, may result in property damage.

IMPORTANT SAFETY INSTRUCTIONS

SAVE THESE INSTRUCTIONS!

▲ WARNING Read and understand all warnings and operating instructions before using any tool or equipment. When using tools or equipment, basic safety precautions should always be followed to reduce the risk of personal injury. Improper operation, maintenance or modification of tools or equipment could result in serious injury and property damage. There are certain applications for which tools and equipment are designed. DeVilbiss Air Power Company strongly recommends that this product NOT be modified and/or used for any application other than for which it was designed.

If you have any questions relative to its application DO NOT use the product until you have written DeVilbiss Air Power Company and we have advised you.

Online contact form at www.devap.com

Postal Mail:

Customer Care Department
213 Industrial Drive
Jackson, TN 38301-9615

Information regarding the safe and proper operation of this tool is available from the following sources:

International Staple, Nail and Tool Association (ISANTA)
512 W. Burlington Ave., Suite 203, La Grange, IL 60525-2245
www.isanta.org

American National Standards Institute, 25 West 43rd Street, 4 floor, New York, NY 10036 www.ansi.org

ANSI SNT-101-2002 Safety Requirements for Portable, Compressed-Air-Actuated Fastener Driving Power Tools

⚠ DANGER

GENERAL SAFETY RULES

1. Read and understand tool labels and manual. Failure to follow warnings could result in **DEATH** or **SERIOUS INJURY**. Fig. 1.

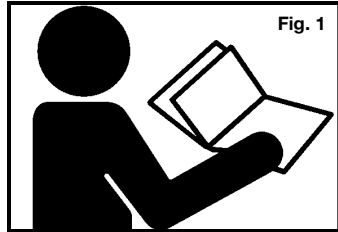

2. Operator and others in work area MUST wear safety glasses with side shields. These safety glasses must conform to ANSI Z87.1 requirements (approved glasses have "Z87" printed or stamped on them). Fig. 2.

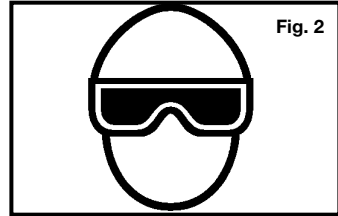

3. Keep fingers AWAY from trigger when not driving fasteners to avoid accidental firing. Never carry tool with finger on trigger. Contact actuation tools will fire a fastener if the safety mechanism is bumped while the trigger is depressed.

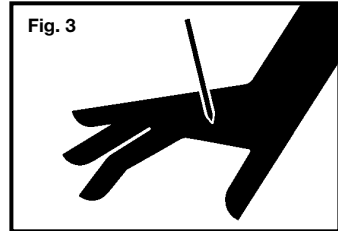

4. Choice of triggering method is important. Check manual for triggering options. See "Using the Tool" section of this manual.

5. Never point tool at yourself or others in work area. Serious injury or death may occur if the tool is activated. Fig. 3

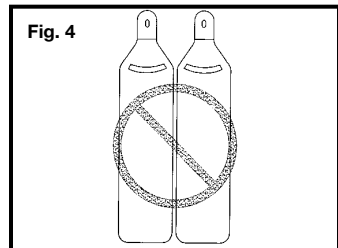

6. Never use oxygen or other bottled gases. Explosion will occur. Never use combustible gases or any other reactive gas as a power source for this tool: explosion and serious personal injury will result. Fig. 4.

7. Wear ear protection to safe-guard against possible hearing loss. Ear protection equipment must conform to ANSI S3.19 requirements. Fig. 5.

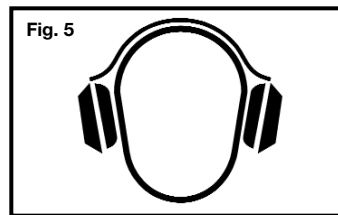

8. Use clean, dry, regulated, compressed air at 70 to 110 PSI, (4.8 to 7.6 BAR). Fig. 6.

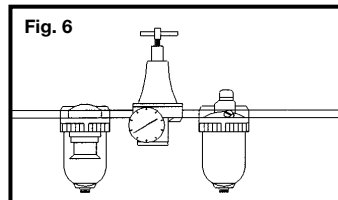

9. Do not connect tool to pressure which potentially exceeds 200 PSI (13.7 BAR).

10. All air line components (hoses, connectors, filters, regulators, etc.) must be rated for a maximum working pressure of at least 150 PSI (10.3 BAR) or 150% of the maximum system pressure, whichever is greater.

11. Connect tool to air supply hose with a coupling that automatically removes all pressure from the tool when the coupling is disconnected. Fig. 7.

12. Disconnect tool from air supply hose before doing tool maintenance, clearing a jammed fastener, leaving work area, moving tool to another location, or handing the tool to another person. Fig. 7.

13. Never use a tool that is leaking air, has missing or damaged parts, or requires repair. Make sure all screws and caps are securely tightened. Fig. 8.

14. Never use tool if safety, trigger or springs are inoperable, missing or damaged. Do not alter or remove safety, trigger, or springs. Make daily inspections for free movement of trigger and safety mechanism. Fig. 8.

15. Do not use tool without safety warning label. If label is missing, damaged or unreadable, contact the Customer Care Department at 1-800-888-2468 for a replacement. Fig. 9.

16. Only use parts and accessories approved by DeVilbiss Air Power Company.

17. Connect tool to air supply before loading fasteners, to prevent a fastener from being fired during connection. The tool driving mechanism may cycle when tool is connected to the air supply. Fig. 10.

18. Always assume the tool contains fasteners. No horseplay. Respect the tool as a working implement. Fig. 11.

19. Operator and bystanders should wear hard hats to safeguard against possible injuries. Fig. 12.

20. Keep bystanders and children away from work area when operating this power tool.

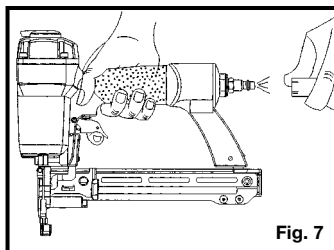

Fig. 7

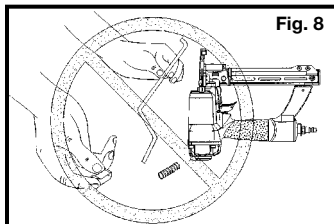

Fig. 8



Fig. 9

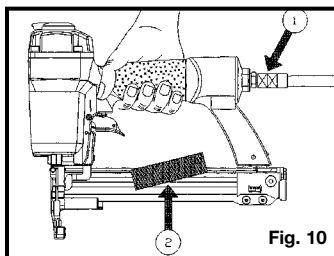

Fig. 10

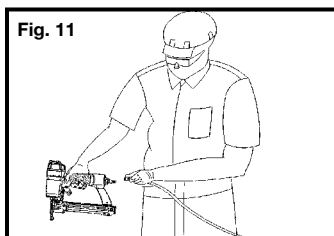

Fig. 11

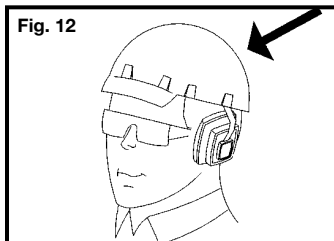
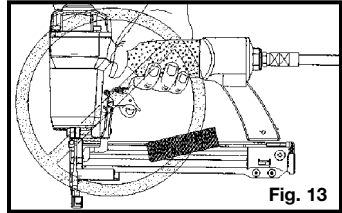
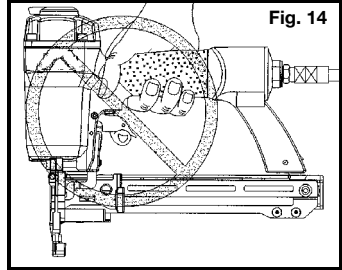

Fig. 12

21. Do not load fasteners with trigger or safety depressed, to prevent unintentional firing of a fastener. Fig. 13



22. Remove finger from trigger when not driving fasteners. Never carry tool with finger on trigger. Contact Actuation tools will fire a fastener if the safety mechanism is bumped while trigger is depressed. Fig. 14.



23. Do not overreach. Keep proper footing and balance at all times when using or handling the tool.

24. Fire fasteners into work surface only: never into materials too hard to penetrate. Fig. 15.

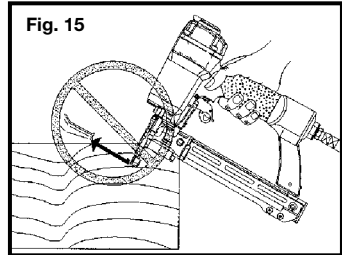

25. Grip tool firmly to maintain control while allowing tool to recoil away from work surface as fastener is driven. With Contact Actuation tools an unwanted fastener will be fired if the safety mechanism is allowed to recontact work surface before trigger is released.

26. Do not drive fasteners on top of other fasteners, or with the tool at too steep an angle: the fasteners can ricochet causing personal injury. Fig. 15.

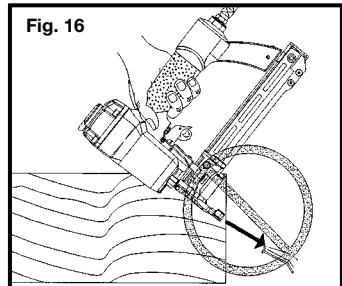

27. Do not drive fasteners close to the edge of the workpiece. The workpiece is likely to split allowing the fastener to fly free or ricochet causing personal injury. Fig. 16.

28. FOR TOOLS USED IN CONTACT ACTUATION MODE, Do not use on scaffoldings or ladders or for tasks in which changing location involves the use of scaffoldings, stairs, ladders, and the like. Do not use for specific tasks such as closing boxes or crates or fitting transportation safety systems on vehicles and wagons. Fig. 17.

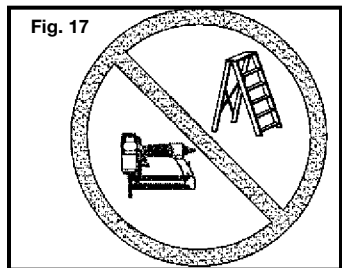

EMPLOYER'S RESPONSIBILITIES

Employer must enforce compliance with the safety warnings and all other instructions contained in this manual.

Keep this manual available for use by all people assigned to use this tool.

For personal safety and proper operation of this tool, read and understand tool labels and manual. Failure to follow warnings could result in DEATH or SERIOUS INJURY. Read and follow all of these instructions carefully.

FUNCTIONAL DESCRIPTION

Ex-Cell Model EBN125 is designed to install generic 18 ga. brad nails of various lengths from $\frac{5}{8}$ " to $1\frac{1}{4}$ " long. Brad nails are loaded into the magazine from the side.

Ex-Cell Model EBN200 is designed to install generic 18 ga. brad nails of various lengths from $\frac{5}{8}$ " to 2" long. Brad nails are loaded into the magazine from the side.

Ex-Cell nailing tools are compact, lightweight, high performance tools designed for molding, interior trim, paneling, cabinetry, picture/mirror frames and crafts. Features include jam release mechanism, tool free adjustable exhaust, fastener reload indicator, safety positioned on rear of nose and removable rubber nose cushion.

CARTON CONTENTS

- | | |
|----------------|------------------------|
| 1) Brad Nailer | 3) Air Tool Oil Bottle |
| 2) Brad Nails | 4) Owner's Manual |

POWER SOURCE

This tool is designed to operate on clean, dry, compressed air at regulated pressures between 70 and 110 PSI (Pounds per Square Inch)(4.8 to 7.6 BAR). The preferred system would include a filter, a pressure regulator, and an automatic oiler located as close to the tool as possible, within 15 ft/4.6 m is ideal. The tool is equipped with a $\frac{1}{4}$ " male "quick connector".

All compressed air contains moisture and other contaminants that are detrimental to internal components of the tool. An air line filter will remove most of these contaminants and significantly prolong the life of the tool. If an in-line oiler is not available: place five or six drops of Air Tool Oil into the tool's air inlet at the beginning of each workday.

PREPARING THE TOOL

NOTE: This tool is shipped completely assembled. No assembly time or tools are required.

1. After reading and understanding this entire manual, connect tool to air supply (Fig. 18).
2. Depress latch and slide magazine cover open (Fig. 19).
3. Insert a strip of fasteners into the side of the magazine, with points down, in contact with the bottom of the magazine channel (A) Fig. 20.
4. Push magazine cover closed (Fig. 21).
5. Observe the low fastener indicator (A) Fig. 22 and reload as needed.
6. Adjust directional exhaust deflector (A) Fig. 23, so that the exhaust air or debris will be directed away from the operator. Grasp the deflector and rotate it to the desired position for the current application.

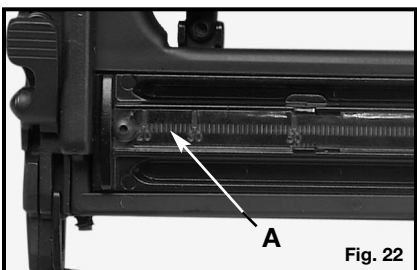
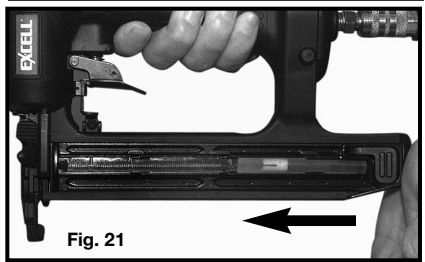
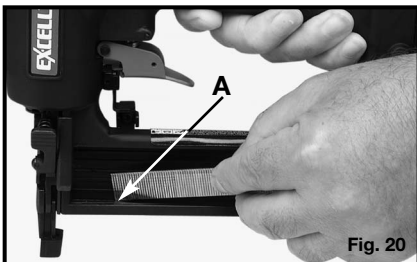
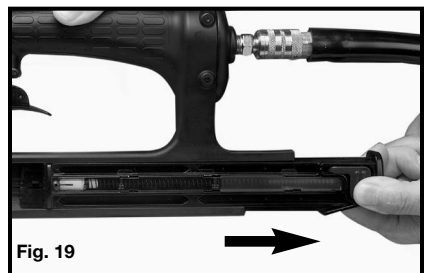
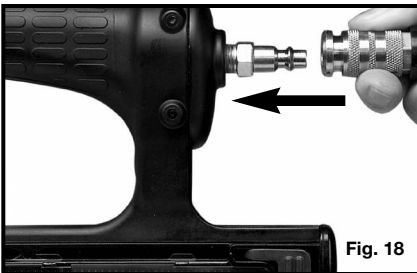

OPERATING INSTRUCTIONS

USING THE TOOL

Complete all steps of PREPARING THE TOOL before using the tool.

This tool is shipped from the factory with a “**single sequential actuation**” trigger. This actuation design requires the release of both the trigger and safety mechanism after each fastener is driven. Sequential actuation is the only triggering option available for this tool. **To fire, grip the tool firmly to maintain control, position nose of tool onto work surface, push the tool firmly against work surface to depress safety (S) Fig. 24, and squeeze trigger to fire a fastener.** Allow tool to recoil away from work surface as fastener is driven. This “**single sequential actuation**” method provides the most accurate fastener placement.

⚠ WARNING Disconnect tool from air supply before performing maintenance, clearing a jammed fastener, leaving work area, moving tool to another location, or handing the tool to another person.

⚠ WARNING Clean and inspect tool daily. Carefully check for proper operation of trigger and safety mechanism. **Do Not** use the tool unless both the trigger and the safety mechanism are functional, or if the tool is leaking air or needs any other repair.

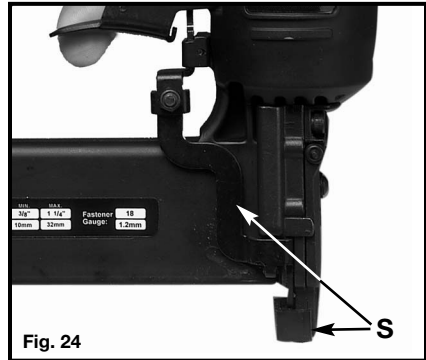

RUBBER NOSE CUSHION

A rubber nose cushion (A) Fig. 25 is provided to reduce marring of the work surface. The rubber cushion can be removed when it is not required.

⚠ WARNING Disconnect tool from air supply before removing or installing rubber cushion.

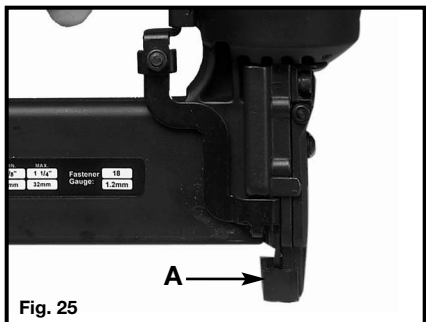

CLEARING A JAMMED FASTENER

⚠ WARNING Disconnect tool from air supply.

1. Open magazine and remove remaining fasteners (Fig. 26 and Fig. 27).
NOTE: Remove fasteners from tool before opening the fastener guide plate. Fasteners are under pressure and may shoot out of magazine which could cause injury.
2. Depress the quick release latch and open the fastener guide plate (Fig. 28).
3. Remove the jammed fastener (Fig. 29).
4. Depress the quick release latch and close the fastener guide plate.

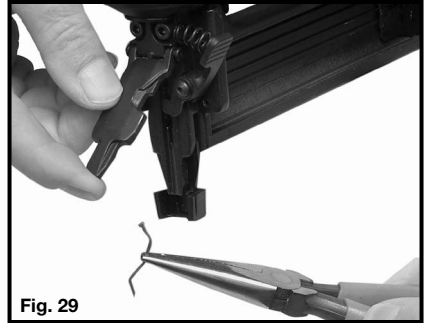

MAINTENANCE

CLEAN AND INSPECT DAILY

⚠ WARNING Disconnect tool from air supply before cleaning and inspection. Correct all problems before placing the tool back in use.

Wipe tool clean and inspect for wear or damage. Use non-flammable cleaning solutions to wipe exterior of tool only if necessary. **DO NOT SOAK** tool with cleaning solutions. Such solutions can damage internal parts.

Inspect trigger and safety mechanism to assure system is complete and functional: no loose or missing parts, no binding or sticking parts.

Keep all screws tight. Loose screws can cause personal injury or damage tool.

If tool is used without an in-line oiler: place 5 or 6 drops of Air Tool Oil into the air inlet of the tool at the beginning of each workday.

SERVICE

SERVICE AND REPAIRS

All quality tools will eventually require servicing or replacement of parts due to wear from normal use. For assistance with your tool, visit our website at www.devap.com for a list of service centers or call the Customer Care Department at 1-800-888-2468. All repairs made by our service centers are fully guaranteed against defective material and workmanship. We cannot guarantee repairs made or attempted by others.

Should you have any questions about your tool, feel free to write us at any time. In any communications, please give all information shown on the nameplate of your tool (model number, type, serial number, etc.).

TROUBLESHOOTING GUIDE

⚠ WARNING Disconnect tool from air supply before performing any Service Procedure.

SYMPTOM	PROBLEMS	SOLUTIONS
1. Air leak near top of tool or in trigger area.	Loose screws. Worn or damaged o-rings or seals.	Tighten screws. Install Overhaul Kit.
2. Tool does nothing or operates sluggishly.	Inadequate air supply. Inadequate lubrication. Worn or damaged o-rings or seals.	Verify adequate air supply. Put 5 or 6 drops of oil into air inlet. Install Overhaul Kit.
3. Air leak near bottom of tool.	Loose screws. Worn or damaged o-rings or bumper.	Tighten screws. Install Overhaul Kit.
4. Tool jams frequently.	Incorrect fasteners. Damaged fasteners. Magazine or nose screws loose. Magazine is dirty. Driver is worn or damaged.	Verify approved fasteners of correct size. Replace w/undamaged fasteners. Tighten screws. Clean magazine. Install "DRIVER" Maintenance Kit.
5. Other.		Contact the Customer Care Department at 1-800-888-2468.

WARRANTY

DeVilbiss Air Power Company warrants to the original purchaser who uses the product in a consumer application (personal, residential or household usage) that all products covered under this warranty are free from defects in material and workmanship for one year from the date of purchase. All products covered by this limited warranty which are used in commercial applications (i.e., income producing) are warranted to be free of defects in material and workmanship for 90 days from the date of original purchase. Products covered under this warranty include air compressors, air tools, service parts, pressure washers, nailers, staplers, and generators.

DeVilbiss Air Power Company will repair or replace, at DeVilbiss' option, products or components which have failed within the warranty period. Service will be scheduled according to the normal work flow and business hours at the service center location, and the availability of replacement parts. All decisions of DeVilbiss Air Power Company with regard to this limited warranty shall be final.

This warranty gives you specific legal rights, and you may also have other rights which vary from state to state.

RESPONSIBILITY OF ORIGINAL PURCHASER (initial User):

- To process a warranty claim on this product, DO NOT return it to the retailer. The product must be evaluated by an Authorized Warranty Service Center. For the location of the nearest Authorized Warranty Service Center call 1-800-888-2468, 24 hours a day, 7 days a week or visit our web site at www.devap.com.
- Retain original cash register sales receipt as proof of purchase for warranty work.
- Use reasonable care in the operation and maintenance of the product as described in the Owners Manual(s).
- Deliver or ship the product to the nearest Authorized Warranty Service Center. Freight costs, if any, must be paid by the purchaser.
- Air compressors with 60 and 80 gallon tanks will be inspected at the site of installation. Contact the nearest Authorized Warranty Service Center that provides on-site service calls for service call arrangements.
- If the purchaser does not receive satisfactory results from the Authorized Warranty Service Center, the purchaser should contact DeVilbiss Air Power Company.

THIS WARRANTY DOES NOT COVER:

- Merchandise sold as reconditioned, used as rental equipment, or floor or display models.
- Merchandise that has become damaged or inoperative because of ordinary wear, misuse*, cold, heat, rain, excessive humidity, freeze damage, use of improper chemicals, negligence, accident, failure to operate the product in accordance with the instructions provided in the Owners Manual(s) supplied with the product, improper maintenance, the use of accessories or attachments not recommended by DeVilbiss Air Power Company, or unauthorized repair or alterations.
 - * An air compressor that pumps air more than 50% during a one hour period is considered misuse because the air compressor is undersized for the required air demand.
- Repair and transportation costs of merchandise determined not to be defective.
- Costs associated with assembly, required oil, adjustments or other installation and start-up costs.
- Expendable parts or accessories supplied with the product which are expected to become inoperative or unusable after a reasonable period of use, including but not limited to sanding disks or pads, saw and shear blades, grinding stones, springs, chisels, nozzles, o-rings, driver blades, air jets, washers and similar accessories.
- Merchandise sold by DeVilbiss Air Power Company which has been manufactured by and identified as the product of another company, such as gasoline engines. The product manufacturer's warranty, if any, will apply.
- **ANY INCIDENTAL, INDIRECT OR CONSEQUENTIAL LOSS, DAMAGE, OR EXPENSE THAT MAY RESULT FROM ANY DEFECT, FAILURE OR MALFUNCTION OF THE PRODUCT IS NOT COVERED BY THIS WARRANTY.** Some states do not allow the exclusion or limitation of incidental or consequential damages, so the above limitation or exclusion may not apply to you.
- **IMPLIED WARRANTIES, INCLUDING THOSE OF MERCHANTABILITY OR FITNESS FOR A PARTICULAR PURPOSE, ARE LIMITED TO ONE YEAR FROM THE DATE OF ORIGINAL PURCHASE.** Some states do not allow limitations on how long an implied warranty lasts, so the above limitations may not apply to you.

 **DeVILBISS AIR POWER COMPANY**
213 Industrial Drive • Jackson, TN 38301-9615
Telephone: 1-800-888-2468
FAX: 1-800-888-9036

Free Manuals Download Website

<http://myh66.com>

<http://usermanuals.us>

<http://www.somanuals.com>

<http://www.4manuals.cc>

<http://www.manual-lib.com>

<http://www.404manual.com>

<http://www.luxmanual.com>

<http://aubethermostatmanual.com>

Golf course search by state

<http://golfingnear.com>

Email search by domain

<http://emailbydomain.com>

Auto manuals search

<http://auto.somanuals.com>

TV manuals search

<http://tv.somanuals.com>