

DESATM UNVENTED (VENT-FREE) GAS LOG HEATER

HEATING PRODUCTS OWNER'S OPERATION AND INSTALLATION MANUAL

For more information, visit www.desatech.com

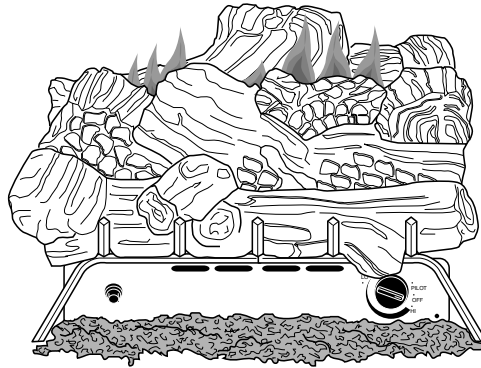

("R" Models) 18", 24", and 30"
Remote-Ready

("V" Models) 18", 24", and 30"
Variable Manually-Controlled

("T" Models) 18", 24", and 30"
Thermostatically-Controlled

Remote-Ready and Variable Manually-Controlled Models Also Design-Certified As Vented Decorative Appliances

WARNING: If the information in this manual is not followed exactly, a fire or explosion may result causing property damage, personal injury, or loss of life.

- Do not store or use gasoline or other flammable vapors and liquids in the vicinity of this or any other appliance.
- **WHAT TO DO IF YOU SMELL GAS**
 - Do not try to light any appliance.
 - Do not touch any electrical switch; do not use any phone in your building.
 - Immediately call your gas supplier from a neighbor's phone. Follow the gas supplier's instructions.
 - If you cannot reach your gas supplier, call the fire department.
- Installation and service must be performed by a qualified installer, service agency, or the gas supplier.

WARNING: Improper installation, adjustment, alteration, service, or maintenance can cause injury or property damage. Refer to this manual for correct installation and operational procedures. For assistance or additional information consult a qualified installer, service agency, or the gas supplier.

WARNING: This appliance is for installation only in a solid-fuel burning masonry or UL127 factory-built fireplace, or in a listed ventless firebox enclosure. It is design-certified for these installations in accordance with ANSI Z21.11.2. Exception: Do not install this appliance in a factory-built fireplace that includes instructions stating it has not been tested or should not be used with unvented gas logs.

WARNING: This is an unvented gas-fired heater. It uses air (oxygen) from the room in which it is installed. Provisions for adequate combustion and ventilation air must be provided. Refer to *Air for Combustion and Ventilation* section on page 4 of this manual.

This appliance may be installed in an aftermarket,* permanently located, manufactured (mobile) home, where not prohibited by local codes.

This appliance is only for use with the type of gas indicated on the rating plate. This appliance is not convertible for use with other gases.

* Aftermarket: Completion of sale, not for purpose of resale, from the manufacturer

Save this manual for future reference.



TABLE OF CONTENTS

SAFETY INFORMATION	2	TROUBLESHOOTING	24
PRODUCT IDENTIFICATION	3	OPTIONAL POSITIONING OF THERMOSTAT SENSING BULB ...	27
OPTIONAL REMOTE CONTROL ACCESSORIES	4	SPECIFICATIONS	28
LOCAL CODES	4	WIRING DIAGRAM	29
UNPACKING	4	SERVICE HINTS	29
PRODUCT FEATURES	4	TECHNICAL SERVICE	29
AIR FOR COMBUSTION AND VENTILATION	4	REPLACEMENT PARTS	29
INSTALLATION	7	ILLUSTRATED PARTS BREAKDOWN AND PARTS LIST	30
OPERATING HEATER	16	ACCESSORIES	36
INSPECTING BURNERS	22	OWNER'S REGISTRATION FORM	37
CLEANING AND MAINTENANCE	23	WARRANTY INFORMATION	Back Cover

SAFETY INFORMATION

WARNINGS

⚠ WARNING: This product contains and/or generates chemicals known to the State of California to cause cancer or birth defects, or other reproductive harm.

IMPORTANT: Read this owner's manual carefully and completely before trying to assemble, operate, or service this heater. Improper use of this heater can cause serious injury or death from burns, fire, explosion, electrical shock, and carbon monoxide poisoning.

⚠ DANGER: Carbon monoxide poisoning may lead to death!

Carbon Monoxide Poisoning: Early signs of carbon monoxide poisoning resemble the flu, with headaches, dizziness, or nausea. If you have these signs, the heater may not be working properly. **Get fresh air at once!** Have heater serviced. Some people are more affected by carbon monoxide than others. These include pregnant women, people with heart or lung disease or anemia, those under the influence of alcohol, and those at high altitudes.

Natural and Propane/LP Gas: Natural and propane/LP gases are odorless. An odor-making agent is added to the gas. The odor helps you detect a gas leak. However, the odor added to the gas can fade. Gas may be present even though no odor exists.

Make certain you read and understand all warnings. Keep this manual for reference. It is your guide to safe and proper operation of this heater.

⚠ WARNING: Any change to this heater or its controls can be dangerous.

⚠ WARNING: Do not use a blower insert, heat exchanger insert, or other accessory not approved for use with this heater.

⚠ WARNING: Do not allow fans to blow directly into the fireplace. Avoid any drafts that alter burner flame patterns. Ceiling fans can create drafts that alter burner flame patterns. Altered burner patterns can cause sooting.

Due to high temperatures, the appliance should be located out of traffic and away from furniture and draperies.

Do not place clothing or other flammable material on or near the appliance. Never place any objects on the heater.

Heater base assembly becomes very hot when running heater. Keep children and adults away from hot surface to avoid burns or clothing ignition. Heater will remain hot for a time after shutdown. Allow surface to cool before touching.

Carefully supervise young children when they are in the room with heater. When using the hand-held remote accessory (Remote-Ready Models Only), keep selector switch in the OFF position to prevent children from turning on burners with remote.

You must operate this heater with a fireplace screen in place. Make sure fireplace screen is closed before running heater.

Keep the appliance area clear and free from combustible materials, gasoline, and other flammable vapors and liquids.

For more information, visit www.desatech.com

SAFETY INFORMATION

Continued

- This appliance is only for use with the type of gas indicated on the rating plate. This appliance is not convertible for use with other gases.
- Do not place propane/LP supply tank(s) inside any structure. Locate propane/LP supply tank(s) outdoors (propane/LP units only).
- If you smell gas
 - shut off gas supply
 - do not try to light any appliance
 - do not touch any electrical switch; do not use any phone in your building
 - immediately call your gas supplier from a neighbor's phone. Follow the gas supplier's instructions
 - if you cannot reach your gas supplier, call the fire department
- This heater shall not be installed in a bedroom or bathroom, unless installed as a vented appliance. See *Installing Damper Clamp Accessory for Vented Operation*, page 10 (Remote-Ready and Variable Manually-Controlled Models Only).
- Before installing in a solid fuel burning fireplace, the chimney flue and firebox must be cleaned of soot, creosote, ashes and loose paint by a qualified chimney cleaner. Creosote will ignite if highly heated. A dirty chimney flue may create and distribute soot within the house. Inspect chimney flue for damage. If damaged, repair flue and firebox before operating heater.
- Do not burn solid-fuel in a masonry or UL127 factory-built fireplace in which a vent-free room heater is installed.
- If fireplace has glass doors, never operate this heater with glass doors closed. If you operate heater with doors closed, heat buildup inside fireplace will cause glass to burst. Make sure there are no obstructions across openings of fireplace.
- To prevent the creation of soot, follow the instructions in *Cleaning and Maintenance*, page 23.
- Before using furniture polish, wax, carpet cleaner, or similar products, turn heater off. If heated, the vapors from these products may create a white powder residue within burner box or on adjacent walls and furniture.
- This heater needs fresh, outside air ventilation to run properly. This heater has an Oxygen Depletion Sensing (ODS) safety shutoff system. The ODS shuts down the heater if enough fresh air is not available. See *Air for Combustion and Ventilation*, pages 4 through 6. If heater keeps shutting off, see *Troubleshooting*, pages 24 through 26.
- Do not run heater
 - where flammable liquids or vapors are used or stored
 - under dusty conditions
- Do not use this heater to cook food or burn paper or other objects.
- Do not use heater if any part has been exposed to or under water. Immediately call a qualified service technician to inspect the room heater and to replace any part of the control system and any gas control which has been under water.
- Do not operate heater if any log is broken. Do not operate heater if a log is chipped (dime-sized or larger).
- Turn heater off and let cool before servicing, installing, or repairing. Make sure the selector switch is in the OFF position (Remote-Ready Models Only). Only a qualified service person should install, service, or repair heater.
- Make sure the selector switch is in the OFF position when you are away from home for long periods of time (Remote-Ready Models Only).
- Remote-ready heaters do not to be connected to any external electrical source.
- Operating heater above elevations of 4,500 feet may cause pilot outage.
- To prevent performance problems, do not use propane/LP fuel tank of less than 100 lb. capacity (propane/LP units only).
- Provide adequate clearances around air openings.

PRODUCT IDENTIFICATION

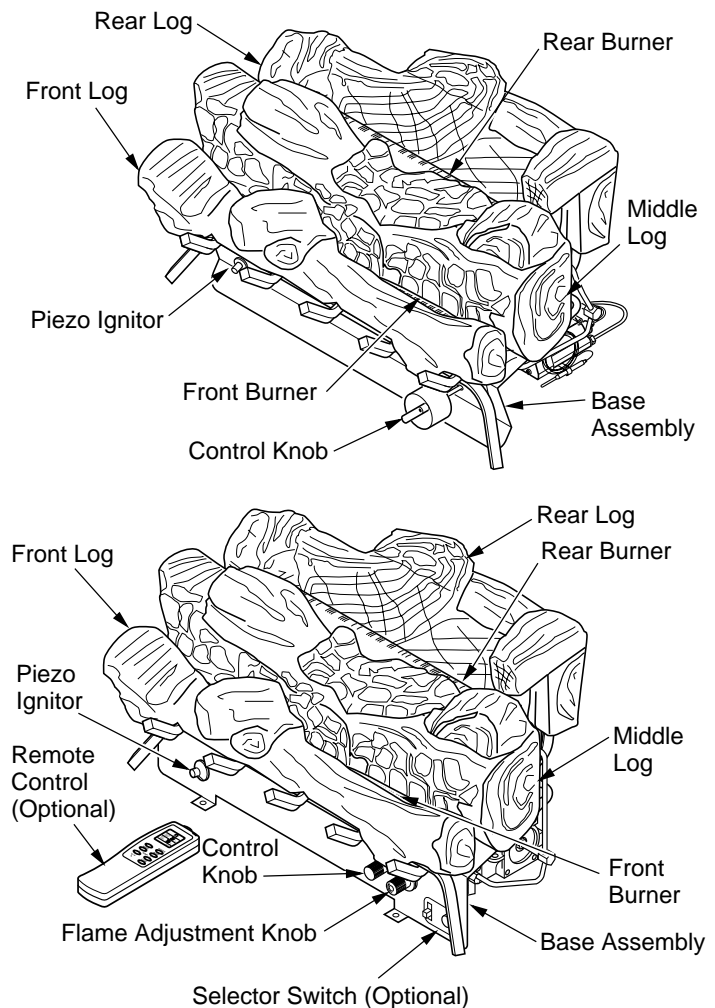

Figure 1 - Product Identification

For more information, visit www.desatech.com



OPTIONAL REMOTE CONTROL ACCESSORIES

There are four optional remote controls that can be purchased separately for Remote-Ready Models Only:

- wall switch
- hand-held ON/OFF remote
- wall thermostat
- hand-held thermostat remote.

See *Accessories*, page 36.

The wall thermostat or hand-held thermostat may not be used where vented decorative listing is required.

LOCAL CODES

Install and use heater with care. Follow all local codes. In the absence of local codes, use the latest edition of *The National Fuel Gas Code ANSI Z223.1/NFPA 54**.

*Available from:

American National Standards Institute, Inc.
 1430 Broadway
 New York, NY 10018

National Fire Protection Association, Inc.
 Batterymarch Park
 Quincy, MA 02269

Note: Where listed vented decorative logs are required, thermostat operation is not permitted.

UNPACKING

CAUTION: Do not remove the data plates from the grate assembly. The data plates contain important warranty and safety information.

1. Remove logs and heater base assembly from carton. *Note:* Do not pick up heater base assembly by burners. This could damage heater. Always handle base assembly by grate.
2. Remove all protective packaging applied to logs and heater for shipment.
3. Check all items for any shipping damage. If damaged, promptly inform dealer where you bought heater.

PRODUCT FEATURES

OPERATION

This heater is clean burning. It requires no outside venting. There is no heat loss out a vent or up a chimney. Heat is generated by both realistic flames and glowing coals. This heater is designed for vent-free operation with flue damper closed. It has been tested and approved to ANSI Z21.11.2 standard for unvented heaters. State and local codes in some areas prohibit the use of vent-free heaters. This heater may also be operated as a vented decorative (ANSI Z21.60) product by opening the flue damper (Non-Thermostat Models Only).

SAFETY DEVICE

This heater has a pilot with an Oxygen Depletion Sensing (ODS) safety shutoff system. The ODS/pilot is a required feature for vent-free room heaters. The ODS/pilot shuts off the heater if there is not enough fresh air.

PIEZO IGNITION SYSTEM

This heater has a piezo ignitor. This system requires no matches, batteries, or other sources to light heater.

AIR FOR COMBUSTION AND VENTILATION

WARNING: This heater shall not be installed in a confined space or unusually tight construction unless provisions are provided for adequate combustion and ventilation air. Read the following instructions to insure proper fresh air for this and other fuel-burning appliances in your home.

Today's homes are built more energy efficient than ever. New materials, increased insulation, and new construction methods help reduce heat loss in homes. Home owners weather strip and caulk around windows and doors to keep the cold air out and the warm air in. During heating months, home owners want their homes as airtight as possible.

While it is good to make your home energy efficient, your home needs to breathe. Fresh air must enter your home. All fuel-burning appliances need fresh air for proper combustion and ventilation.

Exhaust fans, fireplaces, clothes dryers, and fuel burning appliances draw air from the house to operate. You must provide adequate fresh air for these appliances. This will insure proper venting of vented fuel-burning appliances.

PROVIDING ADEQUATE VENTILATION

The following are excerpts from *National Fuel Gas Code, ANSI Z223.1/NFPA 54, Section 5.3, Air for Combustion and Ventilation*.

All spaces in homes fall into one of the three following ventilation classifications:

1. Unusually Tight Construction
2. Unconfined Space
3. Confined Space

The information on pages 4 through 6 will help you classify your space and provide adequate ventilation.

Unusually Tight Construction

The air that leaks around doors and windows may provide enough fresh air for combustion and ventilation. However, in buildings of unusually tight construction, you must provide additional fresh air.

AIR FOR COMBUSTION AND VENTILATION

Continued

Unusually tight construction is defined as construction where:

- walls and ceilings exposed to the outside atmosphere have a continuous water vapor retarder with a rating of one perm (6×10^{-11} kg per pa-sec- m^2) or less with openings gasketed or sealed and
- weather stripping has been added on openable windows and doors and
- caulking or sealants are applied to areas such as joints around window and door frames, between sole plates and floors, between wall-ceiling joints, between wall panels, at penetrations for plumbing, electrical, and gas lines, and at other openings.

If your home meets all of the three criteria above, you must provide additional fresh air. See *Ventilation Air From Outdoors*, page 6.

If your home does not meet all of the three criteria above, proceed to *Determining Fresh-Air Flow For Heater Location*, below.

Confined and Unconfined Space

The *National Fuel Gas Code, ANSI Z223.1/NFPA 54* defines a confined space as a space whose volume is less than 50 cubic feet per 1,000 Btu per hour (4.8 m^3 per kw) of the aggregate input rating of all appliances installed in that space and an unconfined space as a space whose volume is not less than 50 cubic feet per 1,000 Btu per hour (4.8 m^3 per kw) of the aggregate input rating of all appliances installed in that space. Rooms communicating directly with the space in which the appliances are installed*, through openings not furnished with doors, are considered a part of the unconfined space.

* Adjoining rooms are communicating only if there are doorless passageways or ventilation grills between them.

DETERMINING FRESH-AIR FLOW FOR HEATER LOCATION

Determining if You Have a Confined or Unconfined Space

Use this work sheet to determine if you have a confined or unconfined space.

Space: Includes the room in which you will install heater plus any adjoining rooms with doorless passageways or ventilation grills between the rooms.

- Determine the volume of the space (length x width x height).

$$\text{Length} \times \text{Width} \times \text{Height} = \text{_____ cu. ft. (volume of space)}$$

Example: Space size 20 ft. (length) x 16 ft. (width) x 8 ft. (ceiling height) = 2560 cu. ft. (volume of space)

If additional ventilation to adjoining room is supplied with grills or openings, add the volume of these rooms to the total volume of the space.

- Multiply the space volume by 20 to determine the maximum Btu/Hr the space can support.

$$\text{_____ (volume of space)} \times 20 = \text{(Maximum Btu/Hr the space can support)}$$

Example: 2560 cu. ft. (volume of space) x 20 = 51,200 (maximum Btu/Hr the space can support)

- Add the Btu/Hr of all fuel burning appliances in the space.

Vent-free heater	_____	Btu/Hr
Gas water heater*	_____	Btu/Hr
Gas furnace	_____	Btu/Hr
Vented gas heater	_____	Btu/Hr
Gas fireplace logs	_____	Btu/Hr
Other gas appliances* +	_____	Btu/Hr
Total	= _____	Btu/Hr

* Do not include direct-vent gas appliances. Direct-vent draws combustion air from the outdoors and vents to the outdoors.

Example:

Gas water heater		40,000	Btu/Hr
Vent-free heater	+	33,000	Btu/Hr
Total	=	73,000	Btu/Hr

- Compare the maximum Btu/Hr the space can support with the actual amount of Btu/Hr used.

$$\text{_____ Btu/Hr (maximum the space can support)}$$

$$\text{_____ Btu/Hr (actual amount of Btu/Hr used)}$$

Example: 51,200 Btu/Hr (maximum the space can support)
 73,000 Btu/Hr (actual amount of Btu/Hr used)

The space in the above example is a confined space because the actual Btu/Hr used is more than the maximum Btu/Hr the space can support. You must provide additional fresh air. Your options are as follows:

- Rework worksheet, adding the space of an adjoining room. If the extra space provides an unconfined space, remove door to adjoining room or add ventilation grills between rooms. See *Ventilation Air From Inside Building*, page 6.
- Vent room directly to the outdoors. See *Ventilation Air From Outdoors*, page 6.
- Install a lower Btu/Hr heater, if lower Btu/Hr size makes room unconfined.

If the actual Btu/Hr used is less than the maximum Btu/Hr the space can support, the space is an unconfined space. You will need no additional fresh air ventilation.

⚠ WARNING: If the area in which the heater may be operated is smaller than that defined as an unconfined space or if the building is of unusually tight construction, provide adequate combustion and ventilation air by one of the methods described in the *National Fuel Gas Code, ANSI Z223.1/NFPA 54 Section 5.3* or applicable local codes.

AIR FOR COMBUSTION AND VENTILATION

Continued

VENTILATION AIR

Ventilation Air From Inside Building

This fresh air would come from an adjoining unconfined space. When ventilating to an adjoining unconfined space, you must provide two permanent openings: one within 12" of the ceiling and one within 12" of the floor on the wall connecting the two spaces (see options 1 and 2, Figure 2). You can also remove door into adjoining room (see option 3, Figure 2). Follow the *National Fuel Gas Code, ANSI Z223.1/NFPA 54, Section 5.3, Air for Combustion and Ventilation* for required size of ventilation grills or ducts.

Ventilation Air From Outdoors

Provide extra fresh air by using ventilation grills or ducts. You must provide two permanent openings: one within 12" of the ceiling and one within 12" of the floor. Connect these items directly to the outdoors or spaces open to the outdoors. These spaces include attics and crawl spaces. Follow the *National Fuel Gas Code, ANSI Z223.1/NFPA 54, Section 5.3, Air for Combustion and Ventilation* for required size of ventilation grills or ducts.

IMPORTANT: Do not provide openings for inlet or outlet air into attic if attic has a thermostat-controlled power vent. Heated air entering the attic will activate the power vent.

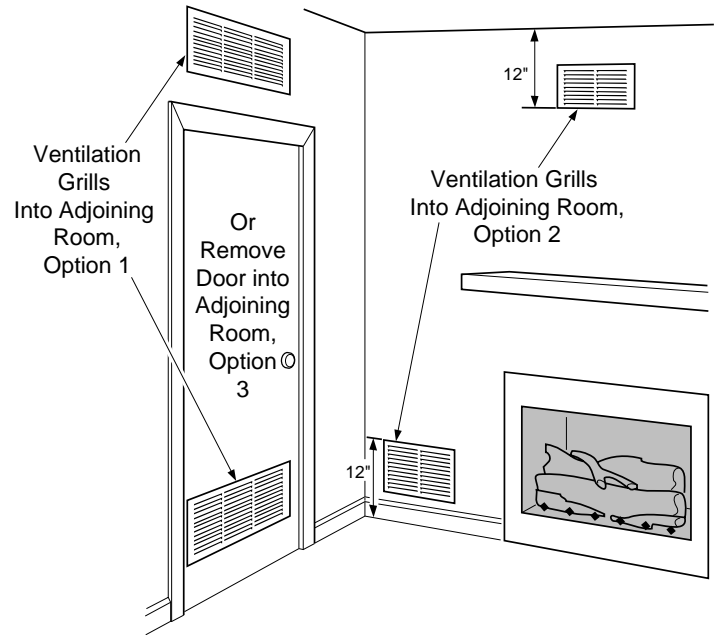

Figure 2 - Ventilation Air from Inside Building

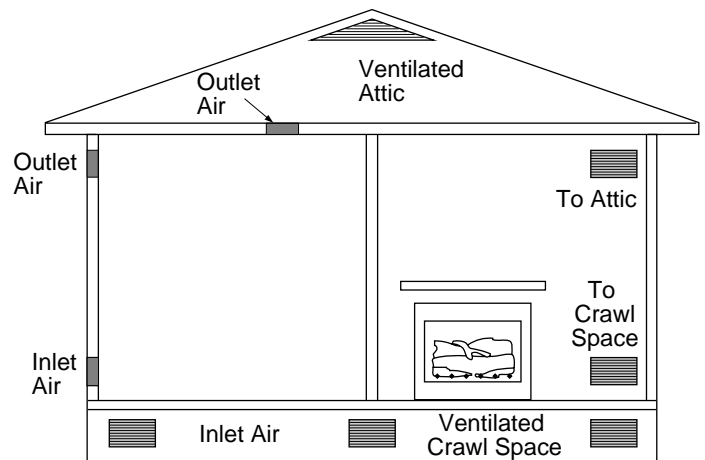

Figure 3 - Ventilation Air from Outdoors

INSTALLATION

NOTICE: This heater is intended for use as supplemental heat. Use this heater along with your primary heating system. Do not install this heater as your primary heat source. If you have a central heating system, you may run system's circulating blower while using heater. This will help circulate the heat throughout the house. In the event of a power outage, you can use this heater as your primary heat source.

⚠ WARNING: A qualified service person must install heater. Follow all local codes.

NOTICE: State or local codes may only allow operation of this appliance in a vented configuration. Check your state or local codes.

⚠ WARNING: Make sure the selector switch is in the OFF position before installing heater (Remote-Ready Models Only).

⚠ WARNING: Before installing in a solid fuel burning fireplace, the chimney flue and firebox must be cleaned of soot, creosote, ashes and loose paint by a qualified chimney cleaner. Creosote will ignite if highly heated. A dirty chimney flue may create and distribute soot within the house. Inspect chimney and firebox flue for damage. If damaged, repair flue and firebox before operating heater.

⚠ WARNING: Seal any fresh air vents or ash clean-out doors located on floor or wall of fireplace. If not, drafting may cause pilot outage or sooting. Use a heat-resistant sealant. Do not seal chimney flue damper.

⚠ WARNING: Never install the heater

- in a bedroom or bathroom unless installed as a vented appliance, see page 10 (Remote-Ready and Variable Manually-Controlled Models Only)
- in a recreational vehicle
- where curtains, furniture, clothing, or other flammable objects are less than 42 inches from the front, top, or sides of the heater
- in high traffic areas
- in windy or drafty areas

⚠ CAUTION: This heater creates warm air currents. These currents move heat to wall surfaces next to heater. Installing heater next to vinyl or cloth wall coverings or operating heater where impurities (such as, but not limited to, tobacco smoke, aromatic candles, cleaning fluids, oil or kerosene lamps, etc.) in the air exist, may discolor walls or cause odors.

IMPORTANT: Vent-free heaters add moisture to the air. Although this is beneficial, installing heater in rooms without enough ventilation air may cause mildew to form from too much moisture. See *Air for Combustion and Ventilation*, pages 4 through 6.

CHECK GAS TYPE

Use the correct gas type (natural or propane/LP) for your unit. If your gas supply is not correct, do not install fireplace. Call dealer where you bought fireplace for proper type fireplace.

INSTALLATION AND CLEARANCES FOR VENT-FREE OPERATION

⚠ WARNING: Maintain the minimum clearances. If you can, provide greater clearances from floor, ceiling, and adjoining wall.

MINIMUM FIREPLACE CLEARANCE TO COMBUSTIBLE MATERIALS	
Log Size	18", 24", 30"
Side Wall	16"
Ceiling	42"
Floor	5"

LOG SIZING REQUIREMENTS				
Log Size	Minimum Firebox Size			
	Height	Depth	Front Width	Rear* Width
18"	17"	14"	20"	14"
24"	17"	14"	26"	18"
30"	17"	14"	32"	22"

*Measured at 14" depth

INSTALLATION

Continued

Carefully follow the instructions below. This will ensure safe installation into a masonry, UL127-listed manufactured fireplace, or listed vent-free firebox.

Minimum Clearances For Side Combustible Material, Side Wall, and Ceiling

- A. Clearances from the side of the fireplace cabinet to any combustible material and wall should follow diagram in Figure 4.

Example: The face of a mantel, bookshelf, etc. is made of combustible material and protrudes 3 1/2" from the wall. This combustible material must be 4" from the side of the fireplace cabinet (see Figure 4).

Note: When installing your gas logs into a manufactured firebox, follow firebox manufacturer's instructions for minimum clearances to combustible materials.

- B. Clearances from the top of the fireplace opening to the ceiling should not be less than 42 inches.

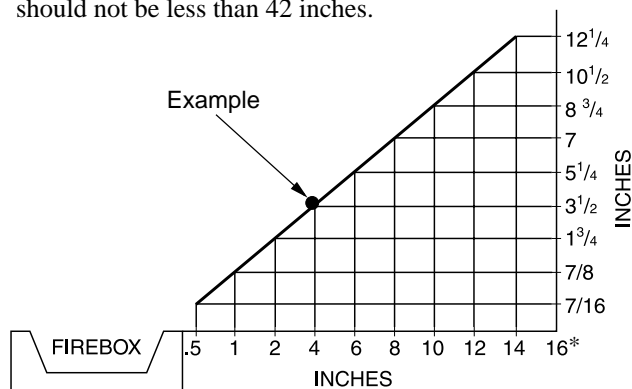

*Minimum 16 inches from Side Wall

Figure 4 - Minimum Clearance for Combustible to Wall

NOTICE: Manual control heaters may be used as a vented product. If so, you must always run heater with chimney flue damper open. If running heater with damper open, noncombustible material above fireplace opening is not needed. Go to *Installing Damper Clamp Accessory for Vented Operation*, page 10.

Minimum Noncombustible Material Clearances

If Not Using Mantel

Note: If using a mantel proceed to *If Using Mantel*. If not using a mantel, follow the information on this page.

You must have noncombustible material(s) above the fireplace opening. Noncombustible materials (such as slate, marble, tile, etc.) must be at least 1/2 inch thick. With sheet metal, you must have

noncombustible material behind it. Noncombustible material must extend at least 8" up (for all models). If noncombustible material is less than 12", you must install the fireplace hood accessory (24" and 30" Models Only). See Figure 5 for minimum clearances.

If Using Mantel

You must have noncombustible material(s) above the fireplace opening. Noncombustible materials (such as slate, marble, tile, etc.) must be at least 1/2 inch thick. With sheet metal, you must have noncombustible material behind it. Noncombustible material must extend at least 8 inches up (for all models). If noncombustible material is less than 12", you must install the fireplace hood accessory (24" and 30" Models Only). Even if noncombustible material is more than 12", you may need the hood accessory to deflect heat away from your mantel shelf. See Figure 5 and Figures 6 and 7, page 9, for minimum clearances.

IMPORTANT: If you cannot meet these minimum clearances, you must operate heater with chimney flue damper open. Go to *Installing Damper Clamp Accessory for Vented Operation*, page 10.

Noncombustible Material Distance (A)	Requirements for Safe Installation
12" or more	Noncombustible material OK.
Between 8" and 12"	24" or 30" Models: Install fireplace hood accessory (GA6050, GA6052, or GA6053 see <i>Accessories</i> , page 36). 18" Model: Noncombustible material OK.
Less than 8"	Noncombustible material must be extended to at least 8". See <i>Between 8" and 12"</i> , above. If you cannot extend material, you must operate heater with flue damper open.

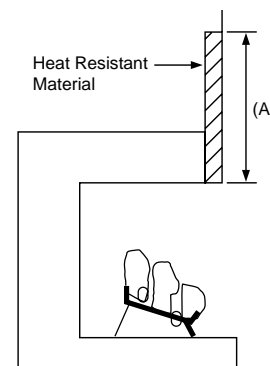

Figure 5 - Heat Resistant Material (Slate, Marble, Tile, etc.) Above Fireplace

INSTALLATION

Continued

MANTEL CLEARANCES

In addition to meeting noncombustible material clearances, you must also meet required clearances between fireplace opening and mantel shelf. If you do not meet the clearances listed below, you will need a hood.

Determining Minimum Mantel Clearance

If you meet minimum clearance between mantel shelf and top of fireplace opening, a hood is not required (see Figure 6).

Determining Minimum Mantel Clearance When Using a Hood

If minimum clearances in Figure 6 are not met, you must have a hood. When using a hood there are still certain minimum mantel clearances required. Follow minimum clearances shown in Figure 7 when using hood.

NOTICE: Surface temperatures of adjacent walls and mantels become hot during operation. Walls and mantels above the firebox may become hot to the touch. If installed properly, these temperatures meet the requirement of the national product standard. Follow all minimum clearances shown in this manual.

NOTICE: If your installation does not meet the minimum clearances shown, you must do one of the following:

- operate the logs only with the flue damper open
- raise the mantel to an acceptable height
- remove the mantel

FLOOR CLEARANCES

- A. If installing appliance on the floor level, you must maintain the minimum distance of 14" to combustibles (see Figure 8).
- B. If combustible materials are less than 14" to the fireplace, you must install appliance at least 5" above the combustible flooring (see Figure 9).

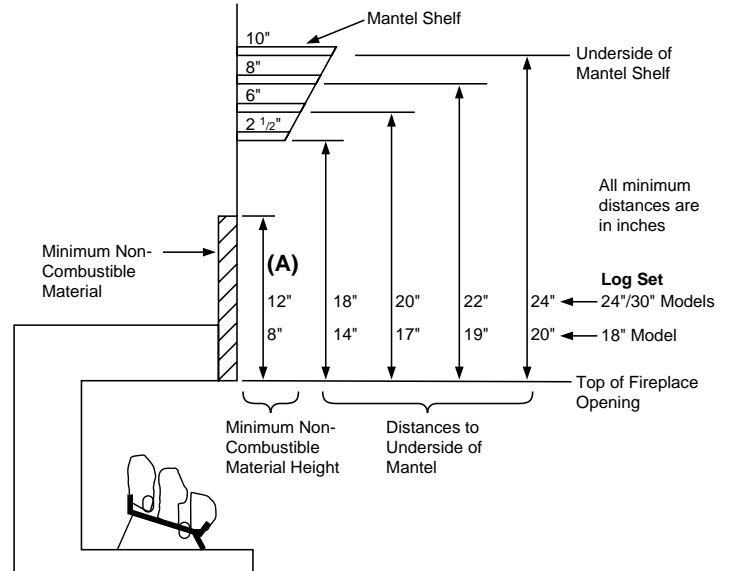

Figure 6 - Minimum Mantel Clearances Without Using Hood

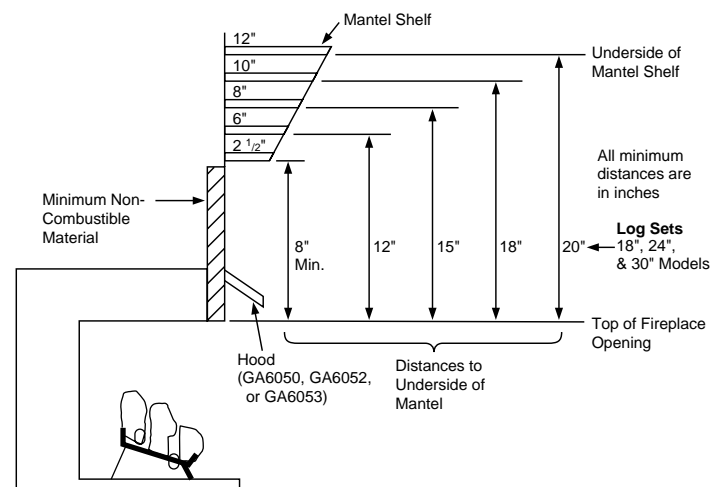

Figure 7 - Minimum Mantel Clearances When Using Hood

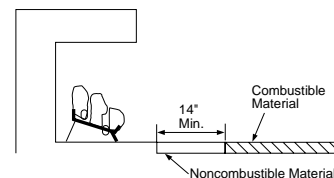

Figure 8 - Minimum Fireplace Clearances If Installed at Floor Level

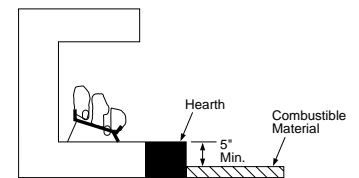

Figure 9 - Minimum Fireplace Clearances Above Combustible Flooring

INSTALLATION

Continued

INSTALLING DAMPER CLAMP ACCESSORY FOR VENTED OPERATION

Note: When used as a vented heater, appliance must be installed only in a solid-fuel burning fireplace with a working flue and constructed of noncombustible material.

If your heater is a manually-controlled model, you may use this heater as a vented product. There are three reasons for operating your heater in the vented mode.

1. The fireplace does not meet the clearance to combustibles requirements for vent-free operation.
2. State or local codes do not permit vent-free operation.
3. You prefer vented operation.

If reasons number 1 or 2 above apply to you, you must permanently open chimney flue damper. You must install the damper clamp accessory (to order, see *Accessories*, page 36). This will insure vented operation (see Figure 10). The damper clamp will keep damper open. Installation instructions are included with clamp accessory.

See chart below for minimum permanent flue opening you must provide. Attach damper clamp so the minimum permanent flue opening will be maintained at all times.

Area of Various Standard Round Flues	
Diameter (ins.)	Area (sq. ins.)
5"	20 sq. inches
6"	29 sq. inches
7"	39 sq. inches
8"	51 sq. inches

Chimney Height (ft.)	Minimum Permanent Flue Opening (sq. ins.)
6' to 15'	39 sq. inches
15' to 30'	29 sq. inches

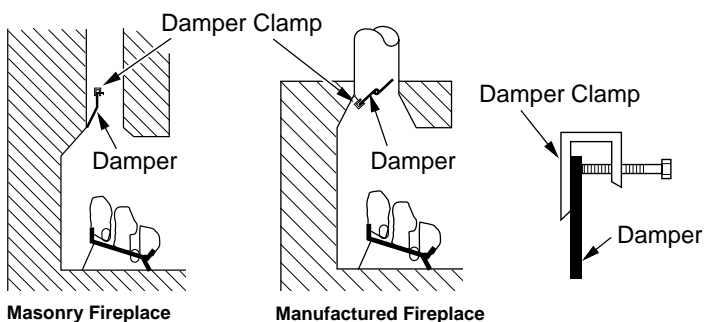

Figure 10 - Attaching Damper Clamp

INSTALLING HEATER BASE ASSEMBLY

⚠ WARNING: You must secure this heater to fireplace floor. If not, heater will move when you adjust controls. Moving heater may cause a gas leak.

⚠ WARNING: If installing in a sunken fireplace, special care is needed. You must raise the fireplace floor to allow access to heater control panel. This will insure adequate air flow and guard against sooting and controls being damaged. Raise fireplace floor with noncombustible material. Make sure material is secure.

⚠ CAUTION: Do not pick up heater base assembly by burners. This could damage heater. Only handle base assembly by grates.

IMPORTANT: Make sure the heater burners are level. If heater is not level, heater will not work properly. For thermostat models, avoid damage to thermostat bulb. Avoid nicks or sharp bends in thermostat bulb wire. Keep thermostat bulb in mounting bracket until ready to mount base to floor. See *Optional Positioning Of Thermostat Sensing Bulb*, page 27.

Installation Items Needed

- hardware package (provided with heater)
- approved flexible gas hose and fittings (not provided) (if allowed by local codes)
- sealant (resistant to propane/LP gas, not provided)
- electric drill with 3/16" masonry drill bit

Note: Install optional GHRCTA Receiver and Hand-Held Remote Control Kit (see *Accessories*, page 36) before installing gas log heater (Remote-Ready Models Only). See installation instructions included with the kit.

1. Apply pipe joint sealant lightly to male threads of gas fitting (not provided). For Variable Manually-Controlled and Thermostatically-Controlled Models connect approved flexible gas hose to gas regulator of heater (see Figure 11, page 11). For Remote-Ready models connect approved flexible gas hose to inlet side of gas control (see Figure 12, page 11).
IMPORTANT: Hold gas regulator with wrench when connecting flexible gas hose (Variable Manually-Controlled and Thermostatically-Controlled Models Only).
2. Locate mounting brackets, bolts, and nuts in hardware package (Variable Manually-Controlled and Thermostatically-Controlled Models Only). Attach mounting brackets to heater base (see Figure 13, page 11). Attach nuts finger tight.

INSTALLATION

Continued

3. Position heater base assembly in fireplace.
4. For Variable Manually-Controlled and Thermostatically-Controlled Models mark screw locations through holes in mounting brackets (see Figure 13). For Remote-Ready Models mark screw locations through holes in front panel of base (see Figure 14). If installing in a brick-bottom fireplace, mark screw locations in mortar joint of bricks.
5. Remove heater base from fireplace.
6. Remove mounting brackets from heater base (Variable Manually-Controlled and Thermostatically-Controlled Models Only).
7. Drill holes at marked locations using 3/16" drill bit.
8. For Variable Manually-Controlled and Thermostatically-Controlled Models attach mounting brackets to fireplace floor using masonry screws provided in hardware package (see Figure 13). Reattach heater base to mounting brackets (see Figure 13). Tighten nuts firmly.
9. For Remote-Ready Models attach base, through holes in front panel of base, to fireplace floor using masonry screws provided in hardware package (see Figure 14).
10. Connect to gas supply. See *Connecting To Gas Supply*, page 12.

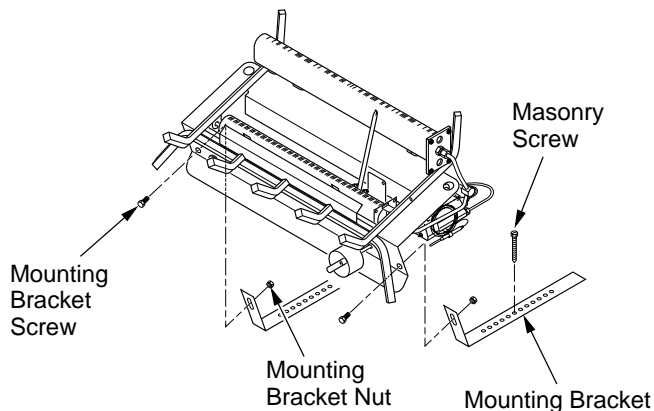

Figure 13 - Attaching Heater to Fireplace Floor (Variable Manually-Controlled and Thermostatically-Controlled Models Only)

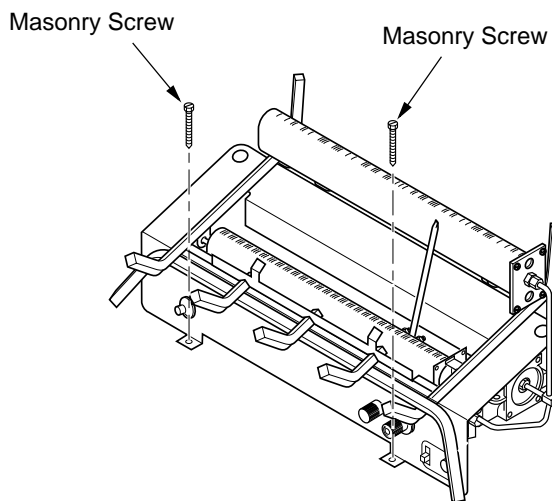

Figure 14 - Attaching Base to Fireplace Floor (Remote-Ready Models Only)

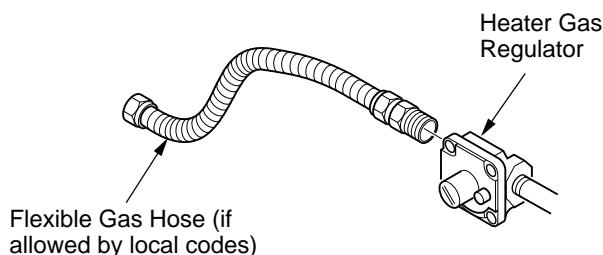

Figure 11 - Attaching Flexible Gas Hose to Heater Gas Regulator (Variable Manually-Controlled and Thermostatically-Controlled Models Only)

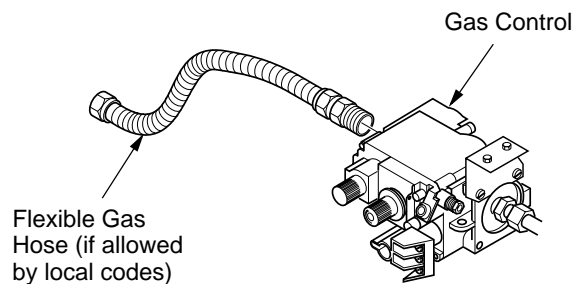

Figure 12 - Attaching Flexible Gas Hose to Heater Gas Regulator (Remote-Ready Models Only)

INSTALLATION

Continued

CONNECTING TO GAS SUPPLY

⚠ WARNING: This appliance requires a 1/2" NPT (National Pipe Thread) inlet connection to the pressure regulator.

⚠ WARNING: A qualified service person must connect heater to gas supply. Follow all local codes.

⚠ CAUTION: Never connect propane/LP fireplace directly to the propane/LP supply. This heater requires an external regulator (not supplied). Install the external regulator between the heater and propane/LP supply.

⚠ WARNING: Never connect natural gas fireplace to private (non-utility) gas wells. This gas is commonly known as wellhead gas.

Installation Items Needed

Before installing heater, make sure you have the items listed below.

- external regulator (supplied by installer)
- piping (check local codes)
- sealant (resistant to propane/LP gas)
- equipment shutoff valve *
- test gauge connection *
- sediment trap
- tee joint
- pipe wrench
- approved flexible gas line with gas connector (if allowed by local codes) (not provided)

* A CSA design-certified equipment shutoff valve with 1/8" NPT tap is an acceptable alternative to test gauge connection. Purchase the optional CSA design-certified equipment shutoff valve from your dealer. See *Accessories*, page 36.

For propane/LP units, the installer must supply an external regulator. The external regulator will reduce incoming gas pressure. You must reduce incoming gas pressure to between 11 and 14 inches of water. If you do not reduce incoming gas pressure, heater regulator damage could occur. Install external regulator with the vent pointing down as shown in Figure 15. Pointing the vent down protects it from freezing rain or sleet.

⚠ CAUTION: Use only new, black iron or steel pipe. Internally-tinned copper tubing may be used in certain areas. Check your local codes. Use pipe of 1/2" diameter or greater to allow proper gas volume to heater. If pipe is too small, undue loss of volume will occur.

Installation must include an equipment shutoff valve, union, and plugged 1/8" NPT tap. Locate NPT tap within reach for test gauge hook up. NPT tap must be upstream from heater (see Figures 16 or 17 page 13, depending on your model).

IMPORTANT: Install equipment shutoff valve in an accessible location. The equipment shutoff valve is for turning on or shutting off the gas to the appliance.

Check your building codes for any special requirements for locating equipment shutoff valve to fireplaces.

Apply pipe joint sealant lightly to male NPT threads. This will prevent excess sealant from going into pipe. Excess sealant in pipe could result in clogged heater valves.

⚠ WARNING: Use pipe joint sealant that is resistant to liquid petroleum (LP) gas.

We recommend that you install a sediment trap in supply line as shown in Figures 16 or 17 page 13, depending on your model. Locate sediment trap where it is within reach for cleaning. Install in piping system between fuel supply and heater. Locate sediment trap where trapped matter is not likely to freeze. A sediment trap traps moisture and contaminants. This keeps them from going into heater controls. If sediment trap is not installed or is installed wrong, heater may not run properly.

⚠ CAUTION: Avoid damage to regulator. Hold gas regulator with wrench when connecting it to gas piping and/or fittings (Variable Manually-Controlled and Thermostatically-Controlled Models Only).

⚠ CAUTION: Avoid damage to gas control. Hold gas control with wrench when connecting it to gas piping and/or fittings (Remote-Ready Models Only).

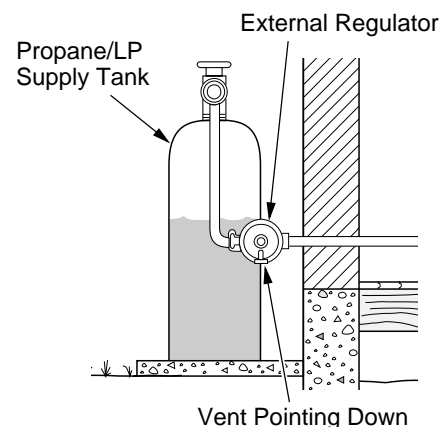

Figure 15 - External Regulator With Vent Pointing Down

For more information, visit www.desatech.com

INSTALLATION

Continued

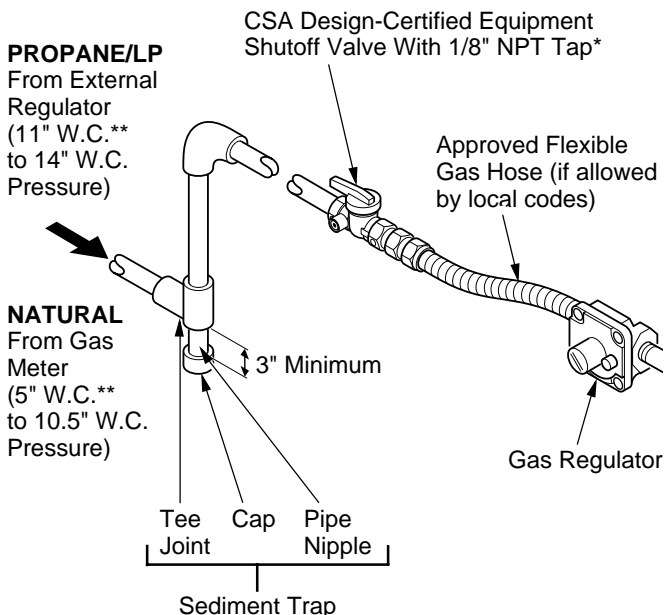

Figure 16 - Gas Connection (Variable Manually-Controlled and Thermostatically-Controlled Models Only)

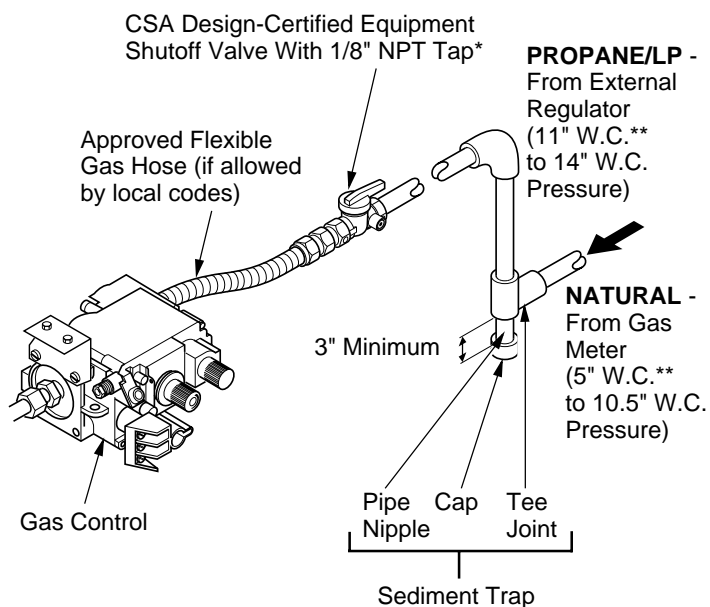

Figure 17 - Gas Connection (Remote-Ready Models Only)

* Purchase the optional CSA design-certified equipment shutoff valve from your dealer. See *Accessories*, page 36.

**Minimum inlet pressure for purpose of input adjustment.

CHECKING GAS CONNECTIONS

⚠ WARNING: Test all gas piping and connections, internal and external to unit, for leaks after installing or servicing. Correct all leaks at once.

⚠ WARNING: Never use an open flame to check for a leak. Apply a noncorrosive leak detection fluid to all joints. Bubbles forming show a leak. Correct all leaks at once.

⚠ CAUTION: Make sure external regulator has been installed between propane/LP supply and heater. See guidelines under *Connecting to Gas Supply*, page 12.

Pressure Testing gas Supply Piping system

Test Pressures In Excess Of 1/2 PSIG (3.5 kPa)

1. Disconnect appliance with its appliance main gas valve (control valve) and equipment shutoff valve from gas supply piping system. Pressures in excess of 1/2 psig will damage heater regulator.
2. Cap off open end of gas pipe where equipment shutoff valve was connected.
3. Pressurize supply piping system by either opening propane/LP supply tank valve for propane/LP gas or opening main gas valve located on or near gas meter for natural gas, or using compressed air.
4. Check all joints of gas supply piping system. Apply noncorrosive leak detection fluid to all joints. Bubbles forming show a leak.
5. Correct all leaks at once.
6. Reconnect heater and equipment shutoff valve to gas supply. Check reconnected fittings for leaks.

Test Pressures Equal To or Less Than 1/2 PSIG (3.5 kPa)

1. Close equipment shutoff valve (see Figure 18, page 14).
2. Pressurize supply piping system by either opening propane/LP supply tank valve for propane/LP gas or opening main gas valve located on or near gas meter for natural gas, or using compressed air.
3. Check all joints from gas meter to equipment shutoff valve for natural gas or propane/LP supply to equipment shutoff valve for propane/LP (see Figure 19, page 14). Apply noncorrosive leak detection fluid to all joints. Bubbles forming show a leak.
4. Correct all leaks at once.

INSTALLATION

Continued

Pressure Testing Heater Gas Connections

1. Open equipment shutoff valve (see Figure 18).
2. Open main gas valve located on or near gas meter for natural gas or open propane/LP supply tank valve.
3. Make sure control knob of heater is in the OFF position.
4. Check all joints from equipment shutoff valve to thermostat gas valve (Thermostat-Controlled Models), to control valve (Manually-Controlled Models), or to gas control (Remote-Ready Models) (see Figures 19 and 20). Apply noncorrosive leak detection fluid to all joints. Bubbles forming show a leak.
5. Correct all leaks at once.
6. Light heater (see *Operating Heater*, pages 16 through 21). Check all other internal joints for leaks.
7. Turn off heater (see *To Turn Off Gas to Appliance*, page 17 for Thermostat-Controlled models, page 18 for Manually-Controlled Models, or page 20 for Remote-Ready Models).

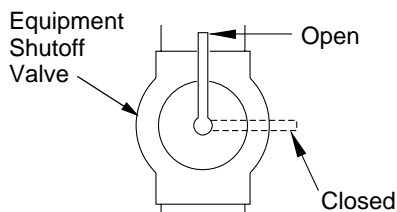

Figure 18 - Equipment Shutoff Valve

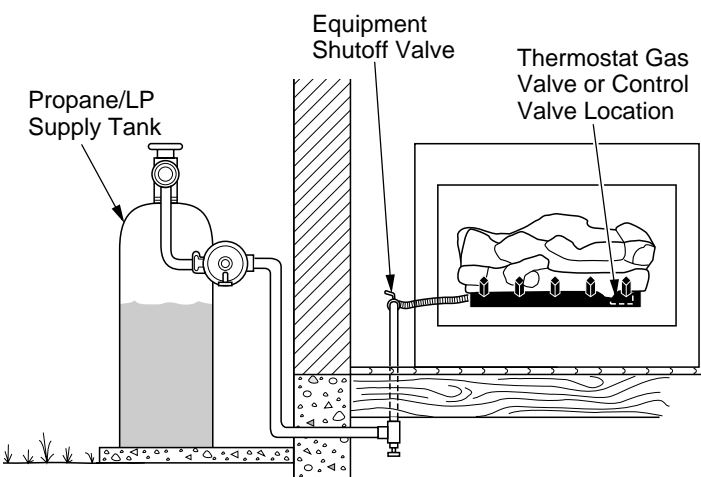

Figure 19 - Checking Gas Joints (Propane/LP Only)

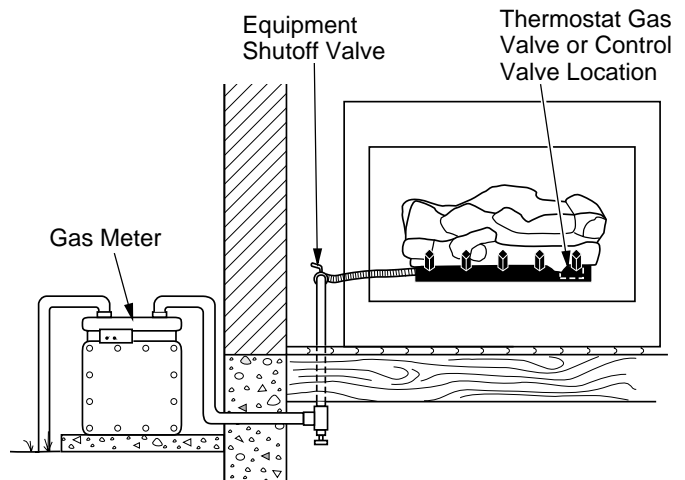

Figure 20 - Checking Gas Joints (Natural Gas Only)

INSTALLING LOGS

WARNING: Failure to position the parts in accordance with these diagrams or failure to use only parts specifically approved with this heater may result in property damage or personal injury.

Each log is marked with a number. These numbers will help you identify the log when installing. It is very important to install these logs exactly as instructed. Do not modify logs. Only use logs supplied with heater.

1. Place front log (#1) on top of the grate. Make sure the notches in the bottom of the log fit over the grate prongs (see Figure 21, page 15). Push back of logs flush with metal grate bars.
2. Rest middle log (#2) behind metal posts on grate assembly. Make sure the grooves in the bottom of the log fit over the grate. Bring the log forward next to the metal posts (see Figure 22, page 15).
3. Slide the grooves in the back of the rear log (#3) against the rear grate prongs. Make sure the log fits securely over the prongs (see Figure 23, page 15). Make sure log is completely vertical and not leaning in toward burner where the flame will touch the log.

INSTALLATION

Continued

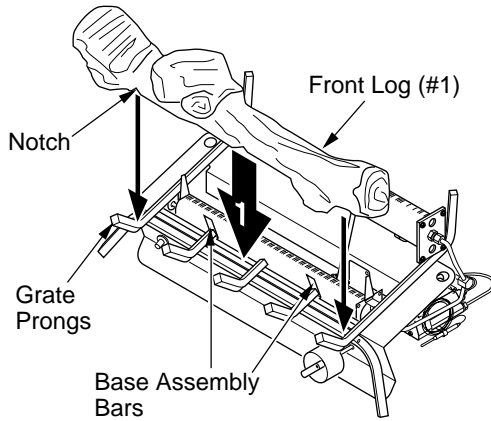

Figure 21 - Installing Front Log (#1)

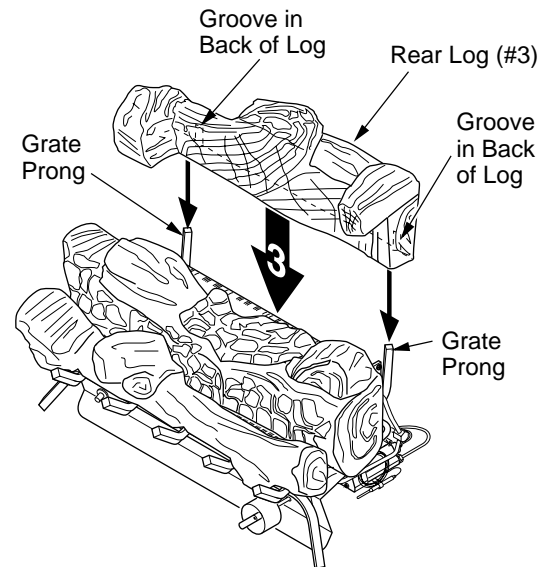

Figure 23 - Installing Rear Log (#3)

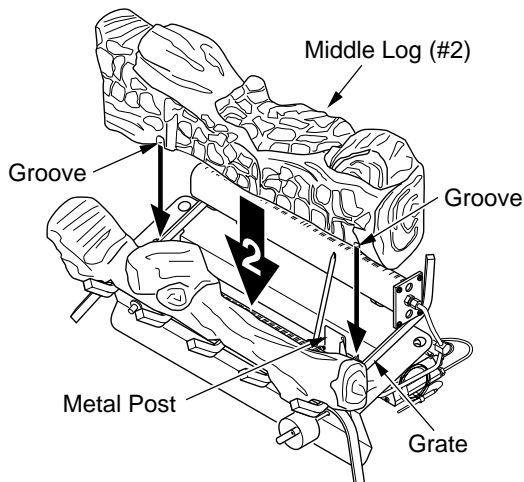

Figure 22 - Installing Middle Log (#2)

Note: Your appliance may vary from model shown but log placement will be the same.

OPERATING HEATER

THERMOSTAT-CONTROLLED MODELS

FOR YOUR SAFETY READ
BEFORE LIGHTING

⚠ WARNING: If you do not follow these instructions exactly, a fire or explosion may result causing property damage, personal injury or loss of life.

- A. This appliance has a pilot which must be lighted by hand. When lighting the pilot, follow these instructions exactly.
- B. **BEFORE LIGHTING** smell all around the appliance area for gas. Be sure to smell next to the floor because some gas is heavier than air and will settle on the floor.

WHAT TO DO IF YOU SMELL GAS

- Do not try to light any appliance.
 - Do not touch any electric switch; do not use any phone in your building.
 - Immediately call your gas supplier from a neighbor's phone. Follow the gas supplier's instructions.
 - If you cannot reach your gas supplier, call the fire department.
- C. Use only your hand to push in or turn the gas control knob. Never use tools. If the knob will not push in or turn by hand, don't try to repair it, call a qualified service technician or gas supplier. Force or attempted repair may result in a fire or explosion.
 - D. Do not use this appliance if any part has been under water. Immediately call a qualified service technician to inspect the appliance and to replace any part of the control system and any gas control which has been under water.



LIGHTING
INSTRUCTIONS**⚠ WARNING:**

- If fireplace has glass doors, never operate this heater with glass doors closed. If you operate heater with doors closed, heat buildup inside fireplace will cause glass to burst. Make sure there are no obstructions across openings of fireplace.
- You must operate this heater with a fireplace screen in place. Make sure fireplace screen is closed before running heater.

NOTICE: During initial operation of new heater, burning logs will give off a paper-burning smell. Orange flame will also be present. Open damper or window to vent smell. This will only last a few hours.

Note: Home owners generally prefer to operate their heater with the chimney damper closed. This will put all the heat into the room. However, there may be times you will desire the full flames of the HI heat setting but will find the heat output excessive. You can open the chimney damper (if you have one) fully or partially to release some of the heat.

⚠ WARNING: Damper handle will be hot if heater has been running.

1. **STOP!** Read the safety information column 1.
2. Make sure equipment shutoff valve is fully open.
3. Turn control knob clockwise  to the OFF position.
4. Wait five (5) minutes to clear out any gas. Then smell for gas, including near the floor. If you smell gas, STOP! Follow "B" in the safety information, column 1. If you don't smell gas, go to the next step.
5. Turn control knob counterclockwise  to the PILOT position. Press in control knob for five (5) seconds (see Figure 24).

Note: You may be running this heater for the first time after hooking up to gas supply. If so, the control knob may need to be pressed in for 30 seconds or more. This will allow air to bleed from the gas system.

6. With control knob pressed in, press and release ignitor button. This will light pilot. The pilot is attached to the front burner. If needed, keep pressing ignitor button until pilot lights.

Note: If pilot does not stay lit, contact a qualified service person or gas supplier for repairs. Until repairs are made, light pilot with match. To light pilot with match, see *Manual Lighting Procedure* on page 17.
7. Keep control knob pressed in for 30 seconds after lighting pilot. After 30 seconds, release control knob.
 - If control knob does not pop out when released, contact a qualified service person or gas supplier for repairs.

Note: If pilot goes out, repeat steps 3 through 7. This heater has a safety interlock system. Wait one (1) minute for system to reset before lighting pilot again.

8. Turn control knob counterclockwise  to desired heating level. The burners should light. Set control knob to any heat level between HI and LO.

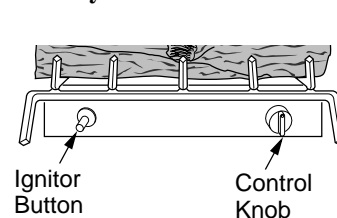

Figure 24 - Control Knob and Ignitor Button Location

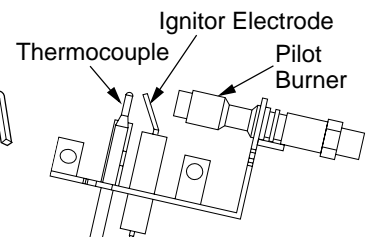

Figure 25 - Pilot Ignitor Location

OPERATING HEATER

Continued

⚠ CAUTION: Do not try to adjust heating levels by using the equipment shutoff valve.

TO TURN OFF GAS TO APPLIANCE

Shutting Off Heater

Turn control knob clockwise  to the OFF position.

Shutting Off Burners Only (pilot stays lit)

Turn control knob clockwise  to the PILOT position.

THERMOSTAT CONTROL OPERATION

The thermostat control knob can be set to any comfort level between HI and LO. The thermostat will gradually modulate the heat output and flame height from higher to lower settings, or pilot, in order to maintain the comfort level you select. The ideal comfort setting will vary by household depending upon the amount of space to be heated, the output of the central heating system, etc.

Note: Selecting the HI setting with the control knob will cause the burner to remain fully on, without modulating down in most cases.

MANUAL LIGHTING PROCEDURE

1. Follow steps 1 through 5 under *Lighting Instructions*, page 16.
2. Depress control knob and light pilot with match.
3. Keep control knob pressed in for 30 seconds after lighting pilot. After 30 seconds, release control knob. Now follow step 8, page 16.

MANUALLY-CONTROLLED MODELS

FOR YOUR SAFETY READ BEFORE LIGHTING

⚠ WARNING: If you do not follow these instructions exactly, a fire or explosion may result causing property damage, personal injury or loss of life.

- A. This appliance has a pilot which must be lighted by hand. When lighting the pilot, follow these instructions exactly.
- B. **BEFORE LIGHTING** smell all around the appliance area for gas. Be sure to smell next to the floor because some gas is heavier than air and will settle on the floor.

WHAT TO DO IF YOU SMELL GAS

- Do not try to light any appliance.
 - Do not touch any electric switch; do not use any phone in your building.
 - Immediately call your gas supplier from a neighbor's phone. Follow the gas supplier's instructions.
 - If you cannot reach your gas supplier, call the fire department.
- C. Use only your hand to push in or turn the gas control knob. Never use tools. If the knob will not push in or turn by hand, don't try to repair it, call a qualified service technician or gas supplier. Force or attempted repair may result in a fire or explosion.
 - D. Do not use this appliance if any part has been under water. Immediately call a qualified service technician to inspect the appliance and to replace any part of the control system and any gas control which has been under water.

LIGHTING INSTRUCTIONS

⚠ WARNING:

- If fireplace has glass doors, never operate this heater with glass doors closed. If you operate heater with doors closed, heat buildup inside fireplace will cause glass to burst. Make sure there are no obstructions across openings of fireplace.
- You must operate this heater with a fireplace screen in place. Make sure fireplace screen is closed before running heater.

NOTICE: During initial operation of new heater, burning logs will give off a paper-burning smell. Orange flame will also be present. Open damper or window to vent smell. This will only last a few hours.

Note: Home owners generally prefer to operate their heater with the chimney damper closed. This will put all the heat into the room. However, there may be times you will desire the full flames of the High heat setting but will find the heat output excessive. You can open the chimney damper (if you have one) fully or partially to release some of the heat.

⚠ WARNING: Damper handle will be hot if heater has been running.

1. **STOP!** Read the safety information starting in column 1.
2. Make sure equipment shutoff valve is fully open.
3. Press in and turn control knob clockwise  to the OFF position.

OPERATING HEATER (MANUALLY-CONTROLLED MODELS)*Lighting Instructions (Cont.)**Variable Control Operation**To Turn Gas Off To Appliance**Manual Lighting Procedure***OPERATING HEATER (REMOTE-READY MODELS)***For Your Safety Read Before Lighting***OPERATING HEATER***Continued*

4. Wait five (5) minutes to clear out any gas. Then smell for gas, including near the floor. If you smell gas, STOP! Follow "B" in the safety information, starting in column 1 of page 17. If you don't smell gas, go to the next step.

5. Press in control knob and turn counterclockwise  to the PILOT position. Keep control knob pressed in for five (5) seconds (see Figure 26).

Note: You may be running this heater for the first time after hooking up to gas supply. If so, the control knob may need to be pressed in for 30 seconds or more. This will allow air to bleed from the gas system.

6. With control knob pressed in, press and release ignitor button. This will light pilot. The pilot is attached to the front burner. If needed, keep pressing ignitor button until pilot lights.

Note: If pilot does not light, contact a qualified service person or gas supplier for repairs. Until repairs are made, light pilot with match. To light pilot with match, see *Manual Lighting Procedure*, column 2.

7. Keep control knob pressed in for 30 seconds after lighting pilot. After 30 seconds, release control knob.

- If control knob does not pop out when released, contact a qualified service person or gas supplier for repairs.

Note: If pilot goes out, repeat steps 3 through 7.

8. Push in and turn control knob counterclockwise  to the HI position. Both burners should light. Set control knob to desired setting.

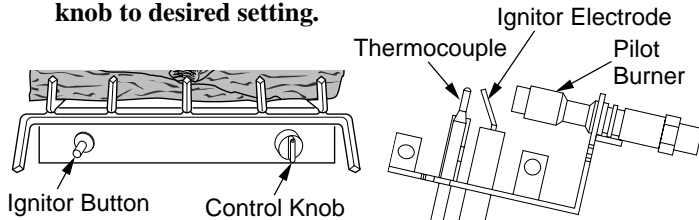

Figure 26 - Control Knob and Ignitor Button Location

Figure 27 - Pilot



VARIABLE CONTROL OPERATION

The variable control valve can be set to any heat setting and flame height desired, by simply turning the control knob until that setting is attained. Even the lowest setting provides realistic flames and glowing embers from two burners. Selecting higher settings produces greater heat output. This results in increased heating comfort.



WARNING: Do not operate heater between locked positions.

CAUTION: Do not try to adjust heating levels by using the equipment shutoff valve.

TO TURN OFF GAS TO APPLIANCE**Shutting Off Heater**

1. Press in and turn control knob clockwise  to the HI position.
2. Turn the control knob clockwise  to the PILOT position.
3. Press in control knob and turn clockwise  to the OFF position.

Shutting Off Burners Only (pilot stays lit)

1. Turn the control knob clockwise  to the HI position.
2. Press in and turn control knob clockwise  to the PILOT position.

MANUAL LIGHTING PROCEDURE

1. Follow steps 1 through 5 under *Lighting Instructions*, pages 17 and 18.
2. Depress control knob and light pilot with match.
3. Keep control knob pressed in for 30 seconds after lighting pilot. After 30 seconds, release control knob. Now follow step 8, column 1.

REMOTE-READY MODELS**FOR YOUR SAFETY READ BEFORE LIGHTING**

WARNING: If you do not follow these instructions exactly, a fire or explosion may result causing property damage, personal injury or loss of life.

- A. This appliance has a pilot which must be lighted by hand. When lighting the pilot, follow these instructions exactly.
- B. **BEFORE LIGHTING** smell all around the appliance area for gas. Be sure to smell next to the floor because some gas is heavier than air and will settle on the floor.

WHAT TO DO IF YOU SMELL GAS

- Do not try to light any appliance.
- Do not touch any electric switch; do not use any phone in your building.
- Immediately call your gas supplier from a neighbor's phone. Follow the gas supplier's instructions.
- If you cannot reach your gas supplier, call the fire department.

For more information, visit www.desatech.com

OPERATING HEATER

Continued

- C. Use only your hand to push in or turn the gas control knob. Never use tools. If the knob will not push in or turn by hand, don't try to repair it, call a qualified service technician or gas supplier. Force or attempted repair may result in a fire or explosion.
- D. Do not use this appliance if any part has been under water. Immediately call a qualified service technician to inspect the appliance and to replace any part of the control system and any gas control which has been under water.

1. **STOP!** Read the safety information, starting in column 2, page 18.
2. Make sure equipment shutoff valve is fully open.
3. Set selector switch in the OFF position.
4. Press in and turn control knob clockwise  to the OFF position (see Figure 28).

⚠ WARNING: Burners will come on automatically within one minute when the selector switch is in the ON position after the pilot is lit.

LIGHTING INSTRUCTIONS

⚠ WARNING

- If fireplace has glass doors, never operate this heater with glass doors closed. If you operate heater with doors closed, heat buildup inside fireplace will cause glass to burst. Make sure there are no obstructions across openings of fireplace.
- You must operate this heater with a fireplace screen in place. Make sure fireplace screen is closed before running heater.

NOTICE: During initial operation of new heater, burning logs will give off a paper-burning smell. Orange flame will also be present. Open damper or window to vent smell. This will only last a few hours.

Note: Home owners generally prefer to operate their heater with the chimney damper closed. This will put all the heat into the room. However, there may be times you will desire the full flames of the HI heat setting but will find the heat output excessive. You can open the chimney damper (if you have one) fully or partially to release some of the heat.

⚠ WARNING: Damper handle will be hot if heater has been running.

5. Wait five (5) minutes to clear out any gas. Then smell for gas, including near the floor. If you smell gas, **STOP!** Follow "B" in the safety information, starting in column 2, page 18. If you don't smell gas, go to the next step.
6. Press in and turn control knob counterclockwise  to the PILOT position. Press in control knob for five (5) seconds (see Figure 28).

Note: You may be running this heater for the first time after hooking up to gas supply. If so, the control knob may need to be pressed in for 30 seconds or less. This will allow air to bleed from the gas system.

7. With control knob pressed in, press and release ignitor button. This will light pilot. The pilot is attached to the front burner. If needed, keep pressing ignitor button until pilot lights.

Note: If pilot does not stay lit, contact a qualified service person or gas supplier for repairs. Until repairs are made, light pilot with match. To light pilot with match, see *Manual Lighting Procedure*, page 20.

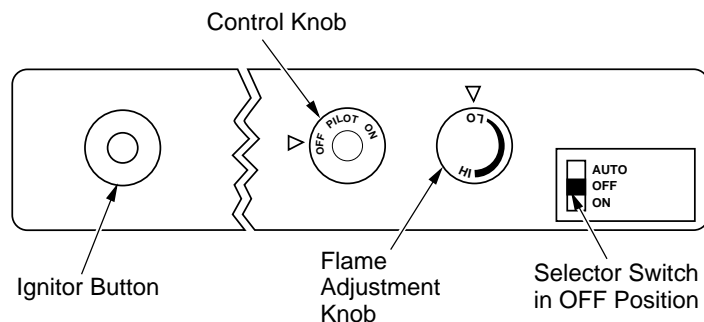

Figure 28 - Control Knob and Ignitor Button Location

OPERATING HEATER

Continued

8. Keep control knob pressed in for 30 seconds after lighting pilot. After 30 seconds, release control knob.
 - If control knob does not pop out when released, contact a qualified service person or gas supplier for repairs.

Note: If pilot goes out, repeat steps 4 through 8, page 19.
9. Slightly push in and turn control knob counterclockwise to the ON position.
10. Wait one minute and switch selector switch to the ON position to light burners. **Note:** AUTO is only functional when using GWMT1 or GWMS2 optional accessories.
11. Set flame adjustment knob to any level between HI and LO.

CAUTION: Do not try to adjust heating levels by using the equipment shutoff valve.

WARNING: Make sure the selector switch is in the OFF position when you are away from home for long periods of time. Heater will come on automatically with selector switch in the ON position.

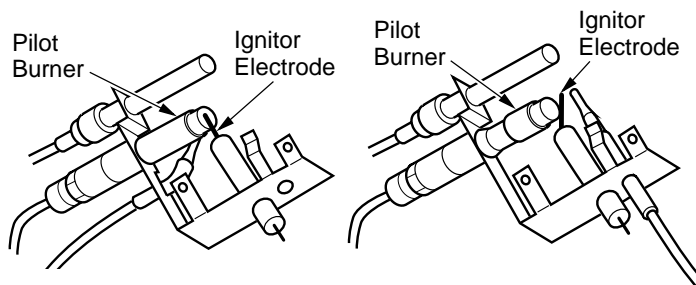

Figure 29 - Pilot (Propane/LP) Figure 30 - Pilot (Natural)

TO TURN OFF GAS TO APPLIANCE

Shutting Off Heater

1. Turn control knob clockwise to the OFF position.
- 2a. Set selector switch in the OFF position.
- 2b. **If Using Optional Hand-Held Remote:** Set selector switch in the OFF position to prevent draining battery.

Shutting Off Burners Only (pilot stays lit)

You may shut off the burners and keep the pilot lit by doing one of the following:

1. Turn control knob clockwise to the PILOT position.
2. Use remote control manual OFF button.
3. Set selector switch in the OFF position.

MANUAL LIGHTING PROCEDURE

1. Follow steps 1 through 6 under *Lighting Instructions*, page 19.
2. Depress control knob and light pilot with match.
3. Keep control knob pressed in for 30 seconds after lighting pilot. After 30 seconds, release control knob. Now follow steps 9 through 11, *Lighting Instructions*, column 1.

OPTIONAL HAND-HELD REMOTE OPERATION

Note: All remote control accessories must be purchased separately (see *Accessories*, page 36). Follow instructions included with the remote control.

NOTICE: You must light the pilot before using the hand-held remote control unit. See *Lighting Instructions* on page 19.

1. After lighting, let pilot flame burn for about one minute. Turn control knob to ON position. Adjust flame adjustment knob anywhere between HI and LO. Slide the selector switch to the REMOTE position (see Figure 31). **Note:** The burner may light if hand-held remote was on when selector switch was last turned off. You can now turn the burner on and off with the hand-held remote control unit.

IMPORTANT: Do not leave the selector switch in the REMOTE or ON position when the pilot is not lit. This will drain the battery.

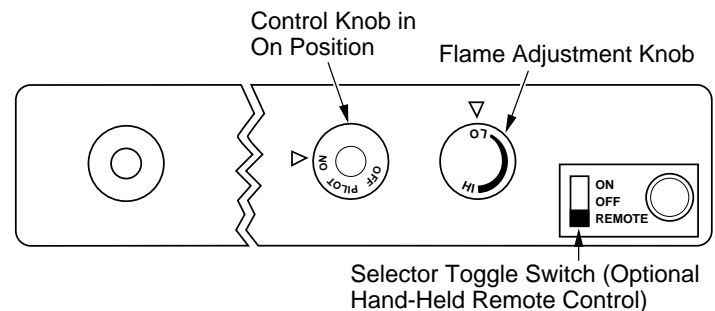

Figure 31 - Setting the Selector switch, Control Knob, and Flame Adjustment Knob for Remote Operation

OPERATING HEATER

Continued

ON/OFF SERIES (MODEL GHRCB)

Hold the control button on the hand-held remote until burner turns on. Hold the control button again until burner turns off (see Figure 32).

TO LOCK press both buttons on hand-held remote control until light stops flashing. Hand-held remote control is now locked. If the fire is on it will be turned off automatically. In the locked state, the light will not light up when any button is pressed.

TO UNLOCK press both buttons together on hand-held remote control until the light stops flashing. The hand-held remote is now unlocked.

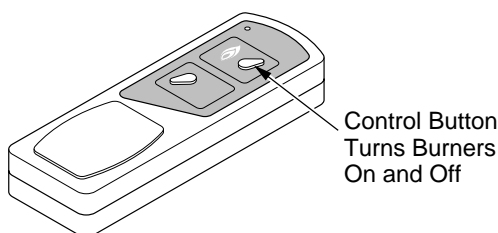

Control Button Turns Burners On and Off

Figure 32 - On/Off Hand-Held Remote Control Unit (GHRCB)

THERMOSTAT SERIES (MODEL GHRCTB)

The hand-held remote can be operated using either the manual mode (MANU) or thermostatic mode (AUTO) (see Figure 33). To select Fahrenheit/Centigrade mode display, carefully press the °C/°F mode button with the end of a paper clip or similar blunt object.

Manual Mode

1. Press the POWER and LOCK buttons together to turn on the hand-held remote control.
2. Press the MANU button to turn on the fireplace.
3. Press the POWER and LOCK buttons together to turn off the fireplace.

Auto (Thermostatic) Mode

1. Press the POWER and LOCK buttons together to turn on the hand-held remote control.
2. Press AUTO button to select this mode.
3. Set the desired room temperature by pressing the TEMP + or - buttons.
4. Press the POWER and LOCK buttons together to turn off the fireplace

Note: Do not leave the hand-held remote in the AUTO mode close to the fireplace. The radiant heat from the fireplace will turn off the fireplace. Ideally, place the hand-held remote in the center of the room facing towards the fireplace.

Note: Do not hold the hand-held remote for a long time. Body temperature will affect its operation in the AUTO mode.

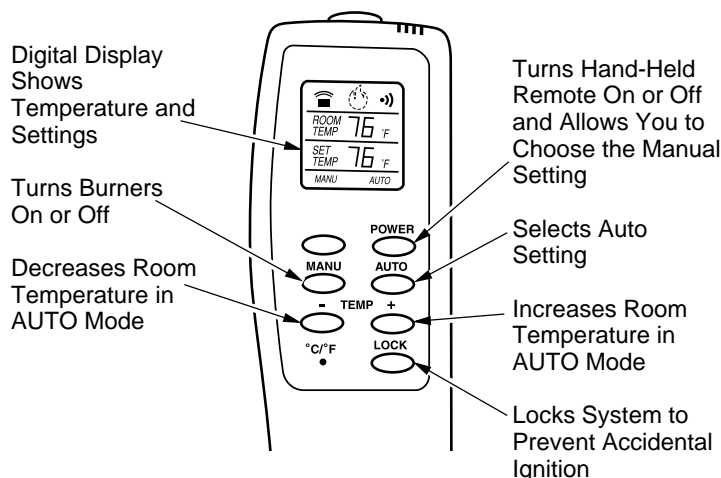

Digital Display Shows Temperature and Settings

Turns Burners On or Off

Decreases Room Temperature in AUTO Mode

Turns Hand-Held Remote On or Off and Allows You to Choose the Manual Setting

Selects Auto Setting

Increases Room Temperature in AUTO Mode

Locks System to Prevent Accidental Ignition

Figure 33 - Thermostat Hand-Held Remote Control Unit (GHRCTB)

Safety Features

When away from home for an extended period of time or as a child safety feature to prevent accidental ignition of the fireplace, the receiver ON/OFF/REMOTE switch should be in the OFF position.

Auto Shutoff Feature

1. If the average room temperature exceeds 82 degrees Fahrenheit (28 degrees Centigrade), the hand-held remote control will perform a safety override and shut the fireplace off. This feature is not available in the MANU mode.
2. The receiver continuously receives signals from the hand-held remote to control the room temperature. If the hand-held remote is misplaced, obstructed, or for any reason cannot transmit to the receiver, the receiver will shut off the fireplace after 8 minutes.

Key Pad Lock Feature

This feature allows the user to lock/unlock the keypad on the hand-held remote in the MANU or AUTO mode to prevent inadvertent operation (i.e. children operating the hand-held remote control, etc.). The keypad is locked in either on or off. Press the POWER and LOCK buttons together to turn the unit on or off.

INSPECTING BURNERS

Check pilot flame pattern and burner flame patterns often.

PILOT FLAME PATTERN

Figure 34 shows a correct pilot flame pattern. Figure 35 shows an incorrect pilot flame pattern. The incorrect pilot flame is not touching the thermocouple. This will cause the thermocouple to cool. When the thermocouple cools, the heater will shut down.

If pilot flame pattern is incorrect, as shown in Figure 35

- turn heater off (see *To Turn Off Gas to Appliance*, page 17 [Thermostat-Controlled Models], page 18 [Manually-Controlled Models], or page 20 [Remote-Ready Models])
- see *Troubleshooting*, pages 24 through 26

Note: The pilot flame on natural gas units will have a slight curve, but flame should be blue and have no yellow or orange color.

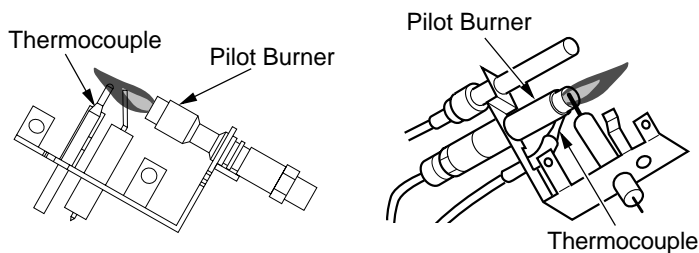

Figure 34 - Correct Pilot Flame Pattern (Your pilot may vary from pilots shown)

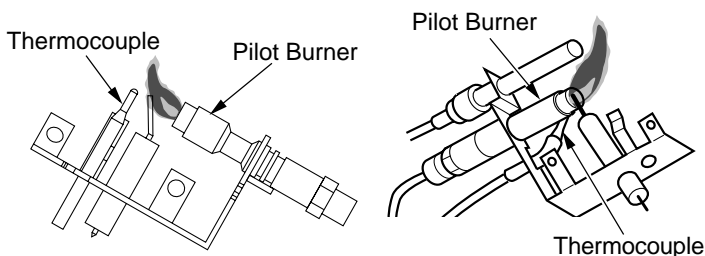

Figure 35 - Incorrect Pilot Flame Pattern (Your pilot may vary from pilots shown)

FRONT BURNER FLAME PATTERN

Figure 36 shows correct front burner flame pattern. Figure 37 shows incorrect front burner flame pattern. The incorrect burner flame pattern shows yellow tipping at top of blue flame.

WARNING: If yellow tipping occurs, your heater could produce increased levels of carbon monoxide. If front burner flame pattern shows yellow tipping, follow instructions at bottom of this page. Yellow flame on rear burner is normal.

NOTICE: Do not mistake orange flames with yellow tipping. Dirt or other fine particles are burned by heater, causing brief patches of orange flame.

If front burner flame pattern is incorrect, as shown in Figure 37

- turn heater off (see *To Turn Off Gas to Appliance*, page 17 [Thermostat-Controlled Models], page 18 [Manually-Controlled Models], or page 20 [Remote-Ready Models])
- see *Troubleshooting*, pages 24 through 26

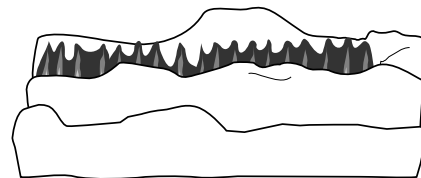

Figure 36 - Correct Front Burner Flame Pattern

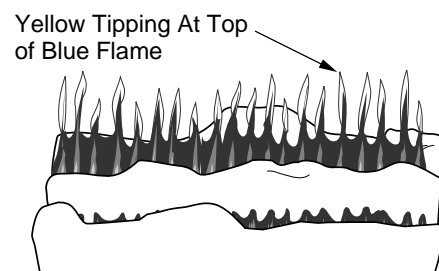

Figure 37 - Incorrect Front Burner Flame Pattern

CLEANING AND MAINTENANCE

⚠ WARNING: Turn off heater and let cool before cleaning.

⚠ CAUTION: You must keep control areas, burners, and circulating air passageways of heater clean. Inspect these areas of heater before each use. Have heater inspected yearly by a qualified service person. Heater may need more frequent cleaning due to excessive lint from carpeting, pet hair, bedding material, etc.

⚠ WARNING: Failure to keep the primary air opening(s) of the burner(s) clean may result in sooting and property damage.

CLEANING BURNER INJECTOR HOLDER AND PILOT AIR INLET HOLE

The primary air inlet holes allow the proper amount of air to mix with the gas. This provides a clean burning flame. Keep these holes clear of dust, dirt, lint, and pet hair. Clean these air inlet holes prior to each heating season. Blocked air holes will create soot. We recommend that you clean the unit every three months during operation and have heater inspected yearly by a qualified service person.

We also recommend that you keep the burner tube and pilot assembly clean and free of dust and dirt. To clean these parts we recommend using compressed air no greater than 30 PSI. Your local computer store, hardware store, or home center may carry compressed air in a can. You can use a vacuum cleaner in the blow position. If using compressed air in a can, please follow the directions on the can. If you don't follow directions on the can, you could damage the pilot assembly.

1. Shut off the unit, including the pilot. Allow the unit to cool for at least thirty minutes.
2. Inspect burner, pilot, and primary air inlet holes on injector holder for dust and dirt (see Figure 38).
3. Blow air through the ports/slots and holes in the burner.
4. Check the injector holder located at the end of the burner tube again. Remove any large particles of dust, dirt, lint, or pet hair with a soft cloth or vacuum cleaner nozzle.
5. Blow air into the primary air holes on the injector holder.
6. In case any large clumps of dust have now been pushed into the burner repeat steps 3 and 4.

Clean the pilot assembly also. A yellow tip on the pilot flame indicates dust and dirt in the pilot assembly. There is a small pilot air inlet hole about two inches from where the pilot flame comes out of the pilot assembly (see Figure 39). With the unit off, lightly blow air through the air inlet hole. You may blow through a drinking straw if compressed air is not available.

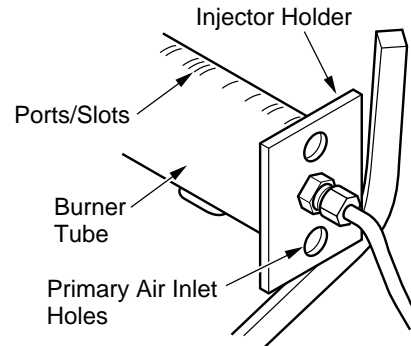

Figure 38 - Injector Holder On Outlet Burner Tube

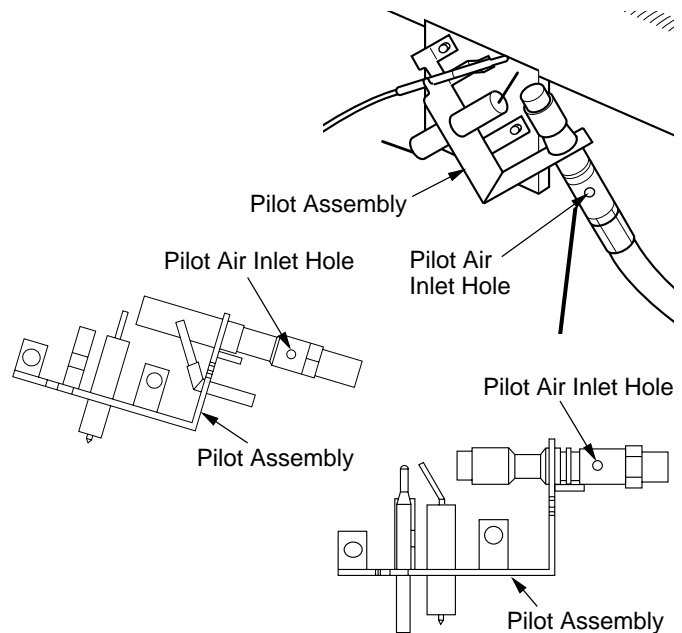

Figure 39 - Pilot Inlet Air Hole (Your pilot may vary from pilots shown)

LOGS

- If you remove logs for cleaning, refer to *Installing Logs*, page 14, to properly replace logs.
- Replace log(s) if broken or chipped (dime-sized or larger).

MAIN BURNER

Periodically inspect all burner flame holes with the heater running. All slotted burner flame holes should be open with yellow flame present. All round burner flame holes should be open with a small blue flame present. Some burner flame holes may become blocked by debris or rust, with no flame present. If so, turn off heater and let cool. Remove blockage, blocked burner flame holes will create soot.

TROUBLESHOOTING

Note: For additional help, visit DESA Heating Products' technical service web site at www.desatech.com.

Note: All troubleshooting items are listed in order of operation.

⚠ WARNING: Turn off and unplug heater and let cool before servicing. Only a qualified service person should service and repair heater.

⚠ CAUTION: Never use a wire, needle, or similar object to clean ODS/pilot. This can damage ODS/pilot unit.

OBSERVED PROBLEM	POSSIBLE CAUSE	REMEDY
When ignitor button is pressed, there is no spark at ODS/pilot	<ol style="list-style-type: none"> Ignitor electrode not connected to ignitor cable Ignitor cable pinched or wet Piezo ignitor nut is loose Broken ignitor cable Bad piezo ignitor Ignitor electrode positioned wrong Ignitor electrode broken 	<ol style="list-style-type: none"> Reconnect ignitor cable Free ignitor cable if pinched by any metal or tubing. Keep ignitor cable dry Tighten nut holding piezo ignitor to base panel of log set. Nut is located behind base panel. Replace ignitor cable Replace piezo ignitor Replace pilot assembly Replace pilot assembly
When ignitor button is pressed, there is spark at ODS/pilot but no ignition	<ol style="list-style-type: none"> Gas supply turned off or equipment shutoff valve closed Control knob not in PILOT position Control knob not pressed in while in PILOT position Air in gas lines when installed Depleted gas supply (propane/LP only) ODS/pilot is clogged Gas regulator setting is not correct 	<ol style="list-style-type: none"> Turn on gas supply or open equipment shutoff valve Turn control knob to PILOT position Press in control knob while in PILOT position Continue holding down control knob. Repeat igniting operation until air is removed Contact local propane/LP gas company Clean ODS/pilot (see <i>Cleaning and Maintenance</i>, page 23) or replace ODS/pilot assembly Replace gas regulator
ODS/pilot lights but flame goes out when control knob is released	<ol style="list-style-type: none"> Control knob not fully pressed in Control knob not pressed in long enough Safety interlock system has been triggered Equipment shutoff valve not fully open Pilot flame not touching thermocouple, which allows thermocouple to cool, causing pilot flame to go out. This problem could be caused by one or both of the following: <ol style="list-style-type: none"> Low gas pressure Dirty or partially clogged ODS/pilot Thermocouple connection loose at control valve Thermocouple damaged Control valve damaged 	<ol style="list-style-type: none"> Press in control knob fully After ODS/pilot lights, keep control knob pressed in 30 seconds Wait one minute for safety interlock system to reset. Repeat ignition operation Fully open equipment shutoff valve A) Contact local natural or propane/LP gas company B) Clean ODS/pilot (see <i>Cleaning and Maintenance</i>, page 23) or replace ODS/pilot assembly Hand tighten until snug, then tighten 1/4 turn more Replace pilot assembly Replace control valve

For more information, visit www.desatech.com

TROUBLESHOOTING

Continued

OBSERVED PROBLEM	POSSIBLE CAUSE	REMEDY
One or both burners do not light after ODS/pilot is lit	<ol style="list-style-type: none"> 1. Inlet gas pressure is too low 2. Burner orifice(s) clogged 3. Mislocated crossover tube 4. Remote selector in OFF position (Remote-Ready Models Only) 5. Wire disconnected from gas control (Remote-Ready Models Only) 	<ol style="list-style-type: none"> 1. Contact local natural or propane/LP gas company 2. Clean burner(s) (see <i>Cleaning and Maintenance</i>, page 23) or replace burner orifice(s) 3. Contact qualified service person 4. Put remote selector in ON position 5. See <i>Wiring Diagram</i>, page 29
Delayed ignition of one or both burners	<ol style="list-style-type: none"> 1. Manifold pressure is too low 2. Burner orifice(s) clogged 3. Mislocated crossover tube 	<ol style="list-style-type: none"> 1. Contact local natural or propane/LP gas company 2. Clean burner(s) (see <i>Cleaning and Maintenance</i>, page 23) or replace burner orifice(s) 3. Contact qualified service person
Burner backfiring during combustion	<ol style="list-style-type: none"> 1. Burner orifice is clogged or damaged 2. Damaged burner 3. Gas regulator defective 	<ol style="list-style-type: none"> 1. Clean burner (see <i>Cleaning and Maintenance</i>, page 23) or replace burner orifice 2. Replace damaged burner 3. Replace gas regulator
Yellow flame in front burner during burner combustion	<ol style="list-style-type: none"> 1. Not enough air 2. Gas regulator defective 	<ol style="list-style-type: none"> 1. Check burner(s) for dirt and debris. If found, clean burner(s) (see <i>Cleaning and Maintenance</i>, page 23) 2. Replace gas regulator
Slight smoke or odor during initial operation	<ol style="list-style-type: none"> 1. Residues from manufacturing processes and logs curing 	<ol style="list-style-type: none"> 1. Problem will stop after a few hours of operation
Heater produces a whistling noise when burners are lit	<ol style="list-style-type: none"> 1. Turning control knob to HI position when burners are cold 2. Air in gas line 3. Air passageways on heater blocked 4. Dirty or partially clogged burner orifice(s) 	<ol style="list-style-type: none"> 1. Turn control knob to LO position and let warm up for a minute 2. Operate burners until air is removed from line. Have gas line checked by local natural or propane/LP gas company 3. Observe minimum installation clearances (see pages 7 through 9) 4. Clean burners (see <i>Cleaning and Maintenance</i>, page 23) or replace burner orifice(s)
White powder residue forming within burner box or on adjacent walls or furniture	<ol style="list-style-type: none"> 1. When heated, vapors from furniture polish, wax, carpet cleaners, etc. may turn into white powder residue 	<ol style="list-style-type: none"> 1. Turn heater off when using furniture polish, wax, carpet cleaners, or similar products
Moisture/condensation noticed on windows	<ol style="list-style-type: none"> 1. Not enough combustion/ventilation air 	<ol style="list-style-type: none"> 1. Refer to Air for <i>Combustion and Ventilation</i> requirements (page 4)

TROUBLESHOOTING

Continued



WARNING: If you smell gas

- Shut off gas supply.
- Do not try to light any appliance.
- Do not touch any electrical switch; do not use any phone in your building.
- Immediately call your gas supplier from a neighbor's phone. Follow the gas supplier's instructions.
- If you cannot reach your gas supplier, call the fire department.

IMPORTANT: Operating heater where impurities in air exist may create odors. Cleaning supplies, paint, paint remover, cigarette smoke, cements and glues, new carpet or textiles, etc., create fumes. These fumes may mix with combustion air and create odors. These odors will disappear over time.

OBSERVED PROBLEM	POSSIBLE CAUSE	REMEDY
Remote does not function (Remote-Ready Models Only)	1. Battery is not installed. Battery power is low	1. Replace 9-volt batteries in receiver and hand-held remote
Heater produces a clicking/ticking noise just after burners are lit or shut off	1. Metal expanding while heating or contracting while cooling	1. This is common with most heaters. If noise is excessive, contact qualified service person
Heater produces unwanted odors	1. Heater burning vapors from paint, hair spray, glues, cleaners, chemicals, new carpet, etc. (See <i>IMPORTANT</i> statement above) 2. Low fuel supply (propane/LP only) 3. Gas leak. See Warning statement at top of page	1. Open window to ventilate room. Stop using odor causing products while heater is running 2. Refill supply tank (propane/LP only) 3. Locate and correct all leaks (see <i>Checking Gas Connections</i> , page 13)
Heater shuts off in use (ODS operates)	1. Not enough fresh air is available 2. Low line pressure 3. ODS/pilot is partially clogged	1. Open window and/or door for ventilation 2. Contact local natural or propane/LP gas company 3. Clean ODS/pilot (see <i>Cleaning and Maintenance</i> , page 23)
Gas odor even when control knob is in OFF position	1. Gas leak. See Warning statement at top of page 2. Control valve or gas control defective	1. Locate and correct all leaks (see <i>Checking Gas Connections</i> , page 13) 2. Replace control valve or gas control
Gas odor during combustion	1. Foreign matter between control valve and burner 2. Gas leak. See Warning statement at top of page	1. Take apart gas tubing and remove foreign matter 2. Locate and correct all leaks (see <i>Checking Gas Connections</i> , page 13)
Log set cycles to pilot, but room temperature drops to a lower than ideal level before log set comes back on	1. Thermostat sensing bulb needs to be repositioned (Thermostat-Controlled Models Only) 2. Hand-held remote control is too close to heater (Remote-Ready Models Only)	1. Reposition thermostat sensing bulb (see Instructions for <i>Optional Positioning of Thermostat Sensing Bulb</i> , page 27) 2. Move hand-held remote control unit farther away from the heater

For more information, visit www.desatech.com

OPTIONAL POSITIONING OF THERMOSTAT SENSING BULB (Thermostat-Controlled Models Only) FOR MASONRY AND FACTORY-BUILT METAL FIREPLACE

If your log set cycles to pilot, but the room temperature drops to a lower than ideal comfort level before the log set comes back on, you may want to reposition the thermostat sensing bulb.

The thermostat sensing bulb is located on the gas valve assembly. This location allows the thermostat to keep the room temperature at an ideal comfort level for most fireplace applications. For positioning the thermostat sensing bulb elsewhere, an adhesive-backed mounting clip is available (see Figure 41).

Tools needed: 5/16" hex driver or socket

1. Locate the gas valve assembly and thermostat sensing bulb (see Figure 40).
2. With 5/16" hex driver or socket, loosen the thermostat screw. Carefully slide the thermostat sensing bulb out of the retaining clamp (see Figure 42).

Note: Do not remove the screw. Make sure you tighten the screw after removing the thermostat sensing bulb.

IMPORTANT: Do not force or bend the thermostat sensing bulb or capillary.

3. The thermostat sensing bulb may be located to the lower right front side of fireplace. Determine location of sensing bulb, but do not mount sensing bulb until step 5. If you have a masonry fireplace, see Figure 43 for location.

If you have a factory-built metal fireplace, see Figure 44 for location.

If your fireplace has glass doors, position sensing bulb directly behind door gap on right bottom side (see Figure 45).

4. The mounting clip must be a minimum of 3" from bottom of fireplace to prevent crimping of capillary. Once you have decided on a location, clean the area thoroughly. Remove the paper backing from the adhesive on back of mounting clip. Press the clip into the new location so that the thermostat sensing bulb will be positioned vertically with the capillary at the bottom (see Figure 46). Slide the thermostat sensing bulb into the clip.

IMPORTANT: Do not crimp capillary.

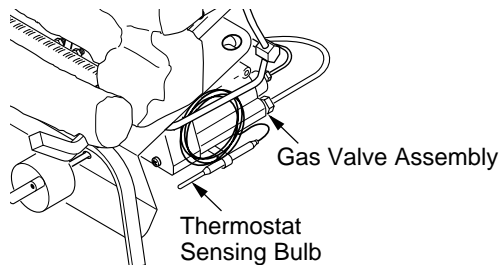

Figure 40 - Location of Gas Valve Assembly and Thermostat Sensing Bulb

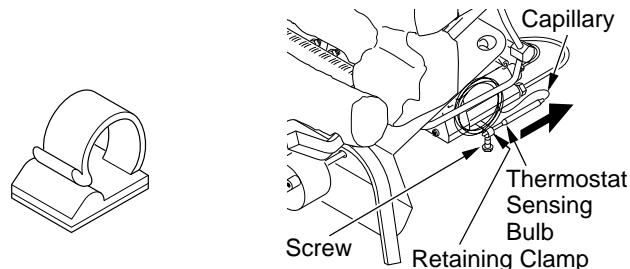

Figure 41 - Adhesive-backed Mounting Clip

Figure 42 - Removing Thermostat Sensing Bulb

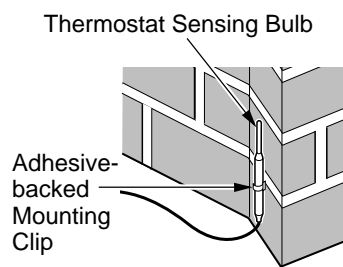

Figure 43 - Locating Thermostat Sensing Bulb on Masonry Fireplace

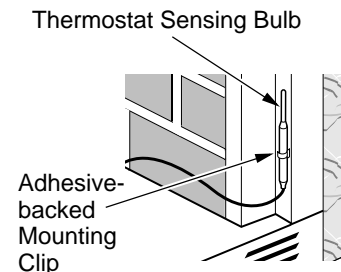

Figure 44 - Locating Thermostat Sensing Bulb on Factory-built Metal Fireplace

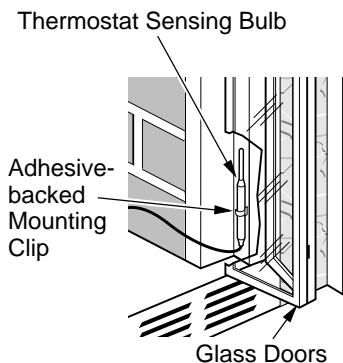

Figure 45 - Installing Thermostat Sensing Bulb behind Glass Doors

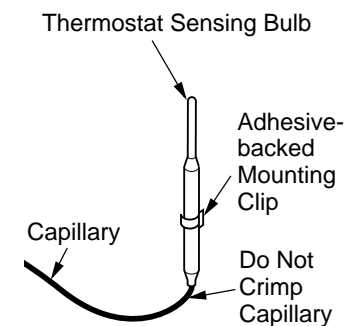

Figure 46 - Positioning the Thermostat Sensing Bulb in the Vertical Position with the Capillary at the Bottom

SPECIFICATIONS

	18" Thermostat-Controlled	24" Thermostat-Controlled	30" Thermostat-Controlled
Btu (Variable)	16,000/29,000 - 16,000/26,000	20,000/33,000	21,500/36,000
Type Gas	Propane/LP Only - Natural	Propane/LP Only - Natural	Propane/LP Only - Natural
Ignition	Piezo	Piezo	Piezo
Manifold Pressure	7.9" W.C. - 3.4" W.C.	7.9" W.C. - 3.4" W.C.	7.9" W.C. - 3.4" W.C.
Inlet Gas Pressure (in. of water)			
Maximum	14" - 10.5"	14" - 10.5"	14" - 10.5"
Minimum*	11" - 5"	11" - 5"	11" - 5"
Shipping Weight	26 lbs.	30 lbs.	34 lbs.

* For purpose of input adjustment

	18" Variable Manually-Controlled	24" Variable Manually-Controlled	30" Variable Manually-Controlled
Btu (Variable)	16,000/29,000 - 16,000/26,000	20,000/33,000	21,500/36,000
Type Gas	Propane/LP Only - Natural	Propane/LP Only - Natural	Propane/LP Only - Natural
Ignition	Piezo	Piezo	Piezo
Manifold Pressure	7.9" W.C. - 3.4" W.C.	7.9" W.C. - 3.4" W.C.	7.9" W.C. - 3.4" W.C.
Inlet Gas Pressure (in. of water)			
Maximum	14" - 10.5"	14" - 10.5"	14" - 10.5"
Minimum*	11" - 5"	11" - 5"	11" - 5"
Shipping Weight	26 lbs.	30 lbs.	34 lbs.

* For purpose of input adjustment

	18" Remote-Ready	24" Remote-Ready	30" Remote-Ready
Btu (Variable)	16,000/29,000 - 16,000/26,000	20,000/33,000	21,500/36,000
Type Gas	Propane/LP Only - Natural	Propane/LP Only - Natural	Propane/LP Only - Natural
Ignition	Piezo	Piezo	Piezo
Manifold Pressure	7.9" W.C. - 3.4" W.C.	7.9" W.C. - 3.4" W.C.	7.9" W.C. - 3.4" W.C.
Inlet Gas Pressure (in. of water)			
Maximum	14" - 10.5"	14" - 10.5"	14" - 10.5"
Minimum*	11" - 5"	11" - 5"	11" - 5"
Shipping Weight	32 lbs.	34 lbs.	36 lbs.

* For purpose of input adjustment

WIRING DIAGRAM

(Remote-Ready Models Only)

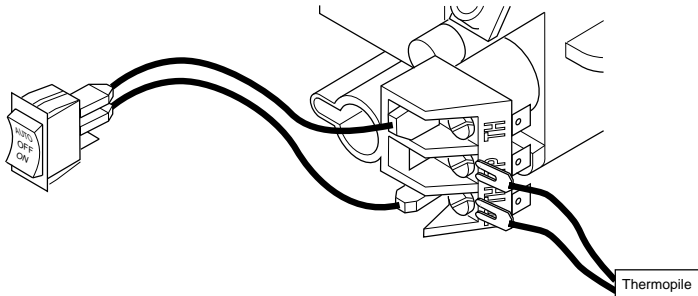

SERVICE HINTS

When Gas Pressure Is Too Low

- pilot will not stay lit
- burners will have delayed ignition
- heater will not produce specified heat
- propane/LP gas supply may be low

You may feel your gas pressure is too low. If so, contact your local propane/LP or natural gas supplier.

TECHNICAL SERVICE

You may have further questions about installation, operation, or troubleshooting. If so, contact DESA Heating Products' Technical Service Department at 1-866-672-6040. When calling please have your model and serial numbers of your heater ready.

You can also visit DESA Heating Products' technical services web site at www.desatech.com.

REPLACEMENT PARTS

Note: Use only original replacement parts. This will protect your warranty coverage for parts replaced under warranty.

PARTS UNDER WARRANTY

Contact authorized dealers of this product. If they can't supply original replacement part(s), call DESA Heating Products' Technical Service Department at 1-866-672-6040.

When calling DESA Heating Products, have ready

- your name
- your address
- model and serial numbers of your heater
- how heater was malfunctioning
- type of gas used (propane/LP or natural gas)
- purchase date

Usually, we will ask you to return the part to the factory.

PARTS NOT UNDER WARRANTY

Contact authorized dealers of this product. If they can't supply original replacement part(s), call DESA Heating Products at 1-866-672-6040 for referral information.

When calling DESA Heating Products, have ready

- model number of your heater
- the replacement part number

ILLUSTRATED PARTS BREAKDOWN

VARIABLE MANUALLY-CONTROLLED
SPLIT OAK MODELS

NVS18NV, NVS18PV, NVS24NV, NVS24PV,
NVS30NV AND NVS30PV

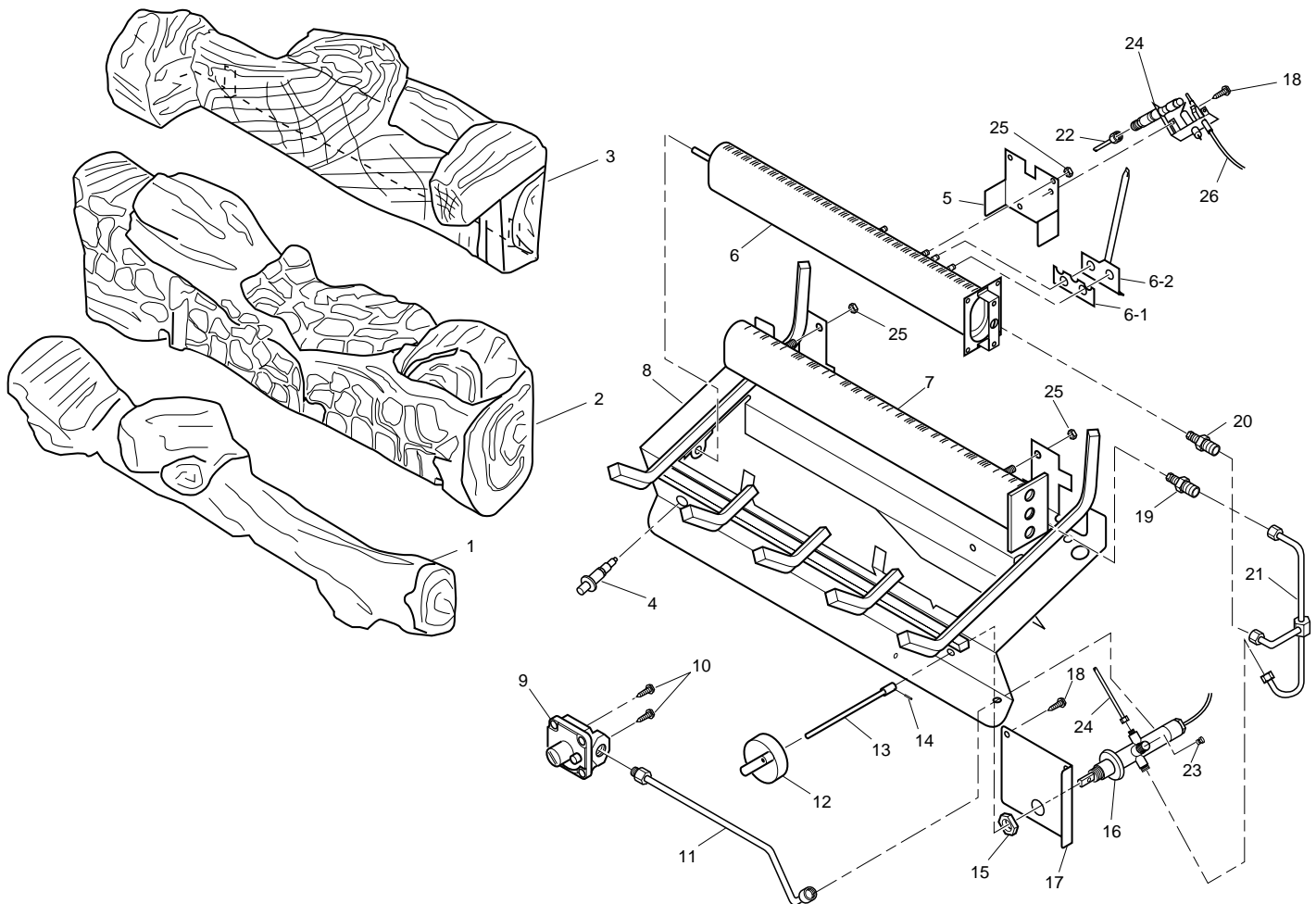

For more information, visit www.desatech.com

PARTS LIST

VARIABLE MANUALLY-CONTROLLED SPLIT OAK MODELS

This list contains replaceable parts used in your heater. When ordering parts, follow the instructions listed under *Replacement Parts* on page 29 of this manual.

KEY NO.	PART NUMBER FOR						DESCRIPTION	QTY.
	NVS18NV	NVS18PV	NVS24NV	NVS24PV	NVS30NV	NVS30PV		
1	110881-01	110881-01	110881-04	110881-04	110881-07	110881-07	Front Log (#1)	1
2	110881-02	110881-02	110881-05	110881-05	110881-08	110881-08	Middle Log (#2)	1
3	110881-03	110881-03	110881-06	110881-06	110881-09	110881-09	Rear Log (#3)	1
4	102445-01	102445-01	102445-01	102445-01	102445-01	102445-01	Piezo Ignitor	1
5	101006-02	101006-02	101006-02	101006-02	101006-02	101006-02	Pilot Bracket	1
6	101330-01	101330-01	101330-05	101330-05	101330-06	101330-06	Front Burner Assembly	1
6-1	101008-01	101008-01	101008-01	101008-01	101008-01	101008-01	Crossover Burner Gasket	1
6-2	101007-01	101007-01	101007-01	101007-01	101007-01	101007-01	Crossover Burner	1
7	109824-01	100999-01	109824-02	109824-02	109824-02	109824-02	Rear Burner Assembly	1
8	101331-10	101331-10	101331-08	101331-08	101331-09	101331-09	Base Assembly with Decals	1
9	098867-09	098867-10	098867-09	098867-10	098867-09	098867-10	Gas Regulator	1
10	M11084-38	M11084-38	M11084-38	M11084-38	M11084-38	M11084-38	Screw	2
11	101011-01	101011-01	101011-02	101011-02	101011-03	101011-03	Inlet Tube	1
12	098354-01	098354-01	098354-01	098354-01	098354-01	098354-01	Control Knob	1
13	098462-03	098462-03	098462-03	098462-03	098462-03	098462-03	Control Rod	1
14	098325-01	098325-01	098325-01	098325-01	098325-01	098325-01	Roll Pin	1
15	098508-01	098508-01	098508-01	098508-01	098508-01	098508-01	Valve Retainer Nut	1
16	102568-01	102568-02	102568-01	102568-02	102568-01	102568-02	Gas Valve	1
17	101005-01	101005-01	101005-01	101005-01	101005-01	101005-01	Valve Bracket	1
18	M11084-26	M11084-26	M11084-26	M11084-26	M11084-26	M11084-26	Screw	4
19	101004-11	101004-10	101004-11	101004-01	101004-04	101004-02	Rear Burner Injector	1
20	101004-11	101004-10	101004-08	101004-02	101004-08	101004-06	Front Burner Injector	1
21	102258-01	102258-01	102258-01	102258-01	102258-01	102258-01	Burner Tube	1
22	099387-08	099387-08	099387-08	099387-08	099387-08	099387-08	Pilot Tube	1
23	098276-01	098276-01	098276-01	098276-01	098276-01	098276-01	1/8" Plug	1
24	107485-01*	107486-01*	107485-01*	107486-01*	107485-01*	107486-01*	O.D.S. Pilot	1
25	098249-01	098249-01	098249-01	098249-01	098249-01	098249-01	Nut	4
26	098271-10	098271-10	098271-06	098271-06	098271-06	098271-06	Ignitor Cable	1
PARTS AVAILABLE — NOT SHOWN								
	100563-01	100563-01	100563-01	100563-01	100563-01	100563-01	Warning Plate	1
	101055-02	101055-02	101055-02	101055-02	101055-02	101055-02	Lighting Instructions Plate	1
	100565-01	100565-01	100565-01	100565-01	100565-01	100565-01	Warning Plate Fastener	1
	100639-01	100639-01	100639-01	100639-01	100639-01	100639-01	Caution Decal	1
	101137-03	101137-01	101137-03	101137-01	101137-03	101137-01	Hardware Kit	1
	GA6060	GA6060	GA6060	GA6060	GA6060	GA6060	Lava Rock	1

* If replacing ODS pilot and your model is pre 2002, your part number will be 103042-01 for natural gas models, 099059-02 for propane/LP gas models.

ILLUSTRATED PARTS BREAKDOWN

THERMOSTAT-CONTROLLED MODELS

NVS18NT, NVS18PT,
NVS24NT, NVS24PT,
NVS30NT and NVS30PT

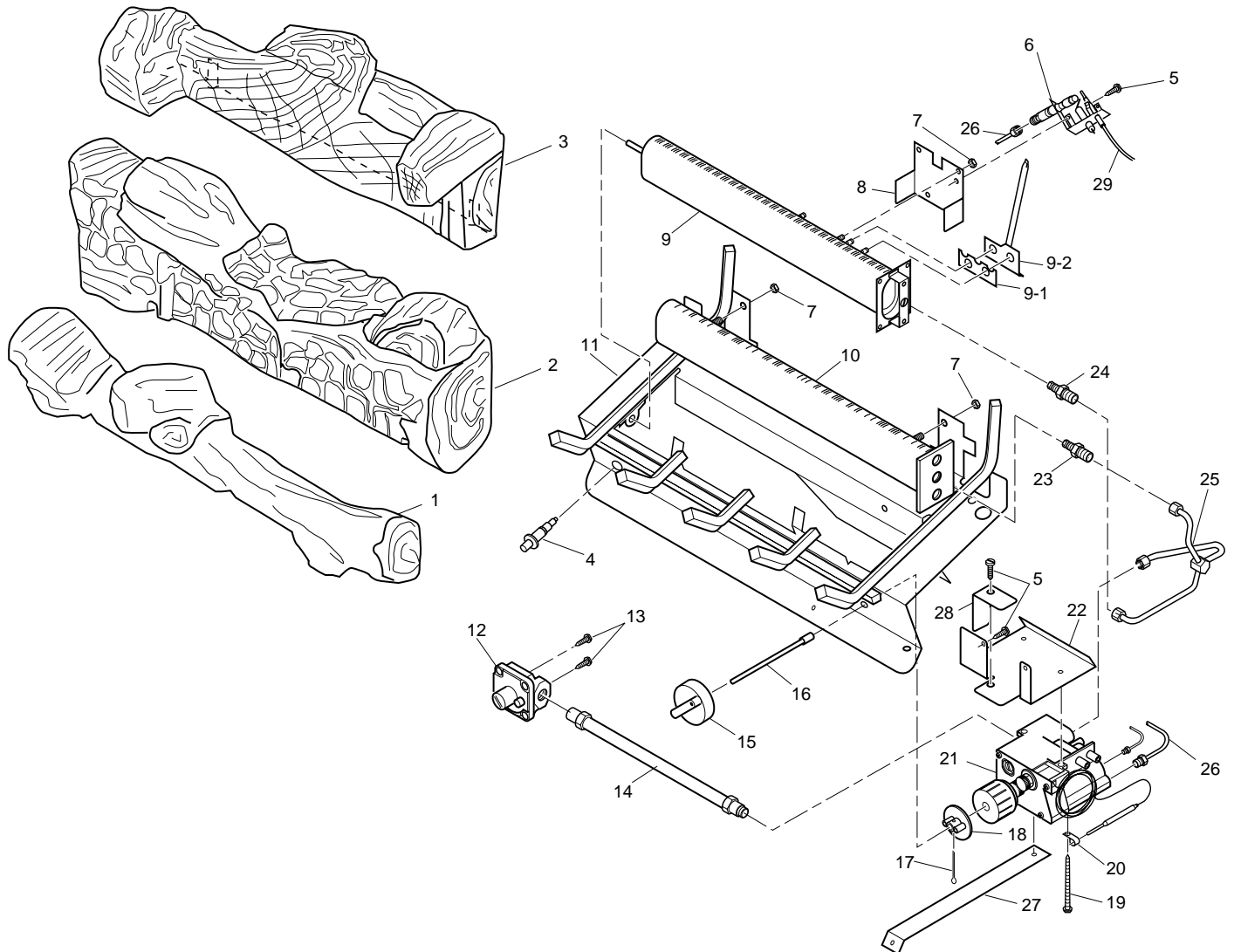

For more information, visit www.desatech.com

PARTS LIST

THERMOSTAT-CONTROLLED MODELS

This list contains replaceable parts used in your heater. When ordering parts, follow the instructions listed under *Replacement Parts* on page 29 of this manual.

KEY NO.	PART NUMBER FOR						DESCRIPTION	QTY.
	NVS18NT	NVS18PT	NVS24NT	NVS24PT	NVS30NT	NVS30PT		
1	110881-01	110881-01	110881-04	110884-04	110881-07	110881-07	Front Log (#1)	1
2	110881-02	110881-02	110881-05	110881-05	110881-08	110881-08	Middle Log (#2)	1
3	110881-03	110881-03	110881-06	110881-06	110881-09	110881-09	Rear Log (#3)	1
4	102445-01	102445-01	102445-01	102445-01	102445-01	102445-01	Piezo Ignitor	1
5	M11084-26	M11084-26	M11084-26	M11084-26	M11084-26	M11084-26	Screw	5
6	107485-01*	107486-01*	107485-01*	107486-01*	107485-01*	107486-01*	O.D.S. Pilot	1
7	098249-01	098249-01	098249-01	098249-01	098249-01	098249-01	Nut	4
8	101006-02	101006-02	101006-02	101006-02	101006-02	101006-02	Pilot Bracket	1
9	101330-01	101330-01	101330-05	101330-05	101330-06	101330-06	Front Burner Assembly	1
9-1	101008-01	101008-01	101008-01	101008-01	101008-01	101008-01	Gasket, Crossover Burner	1
9-2	101007-01	101007-01	101007-01	101007-01	101007-01	101007-01	Crossover Burner	1
10	109824-01	100999-01	109824-02	109824-02	109824-02	109824-02	Rear Burner Assembly	1
11	102223-01	102223-01	102223-02	102223-02	102223-03	102223-03	Base Assembly with Decals	1
12	098867-09	098867-10	098867-09	098867-10	098867-09	098867-10	Gas Regulator	1
13	M11084-38	M11084-38	M11084-38	M11084-38	M11084-38	M11084-38	Screw	2
14	102810-01	102810-01	102810-02	102810-01	102810-03	102810-01	Inlet Tube	1
15	098354-01	098354-01	098354-01	098354-01	098354-01	098354-01	Control Knob	1
15	098462-03	098462-03	098462-03	098462-03	098462-03	098462-03	Control Rod	1
17	100000-01	100000-01	100000-01	100000-01	100000-01	100000-01	Cotter Pin	1
18	101053-01	101053-01	101053-01	101053-01	101053-01	101053-01	Adapter	1
19	099211-01	099211-01	099211-01	099211-01	099211-01	099211-01	Screw	1
20	098544-01	098544-01	098544-01	098544-01	098544-01	098544-01	Thermostat Clamp	1
21	101329-14	101329-15	101329-25	101329-18	101329-25	101329-21	Thermostat Gas Valve Assy.	1
22	100994-01	100994-01	100994-01	100994-01	100994-01	100994-01	Thermostat Bracket	1
23	101004-11	101004-10	101004-11	101004-01	101004-04	101004-02	Rear Burner Injector	1
24	101004-11	101004-10	101004-08	101004-02	101004-08	101004-06	Front Burner Injector	1
25	102811-01	102811-01	102811-01	102811-01	102811-01	102811-01	Thermostat Burner Tube	1
26	099387-09	099387-09	099387-09	099387-09	099387-09	099387-09	Pilot Tube	1
27	102255-01	102255-01	102255-01	102255-01	102255-01	102255-01	Strap	1
28	102764-01	102764-01	102764-01	102764-01	102764-01	102764-01	Heat Shield	1
29	098271-10	098271-10	098271-06	098271-06	098271-06	098271-06	Ignitor Cable	1
PARTS AVAILABLE — NOT SHOWN								
	100563-01	100563-01	100563-01	100563-01	100563-01	100563-01	Warning Plate	1
	101054-01	101054-01	101054-01	101054-01	101054-01	101054-01	Lighting Instructions Plate	1
	100565-01	100565-01	100565-01	100565-01	100565-01	100565-01	Warning Plate Fastener	1
	100639-01	100639-01	100639-01	100639-01	100639-01	100639-01	Caution Decal	1
	101137-01	101137-01	101137-01	101137-01	101137-01	101137-01	Hardware Kit	1
	GA6060	GA6060	GA6060	GA6060	GA6060	GA6060	Lava Rock	1
	102030-01	102030-01	102030-01	102030-01	102030-01	102030-01	Auxiliary Thermostat Mtg. Clip	1

* If replacing ODS pilot and your model is pre 2002, your part number will be 107485-01 for natural gas models, 107486-01 for propane/LP gas models.

ILLUSTRATED PARTS BREAKDOWN

REMOTE-READY VARIABLE CONTROL
MODELS

NVS18NR, NVS18PR, NVS24NR, NVS24PR,
NVS30NR AND NVS30PR

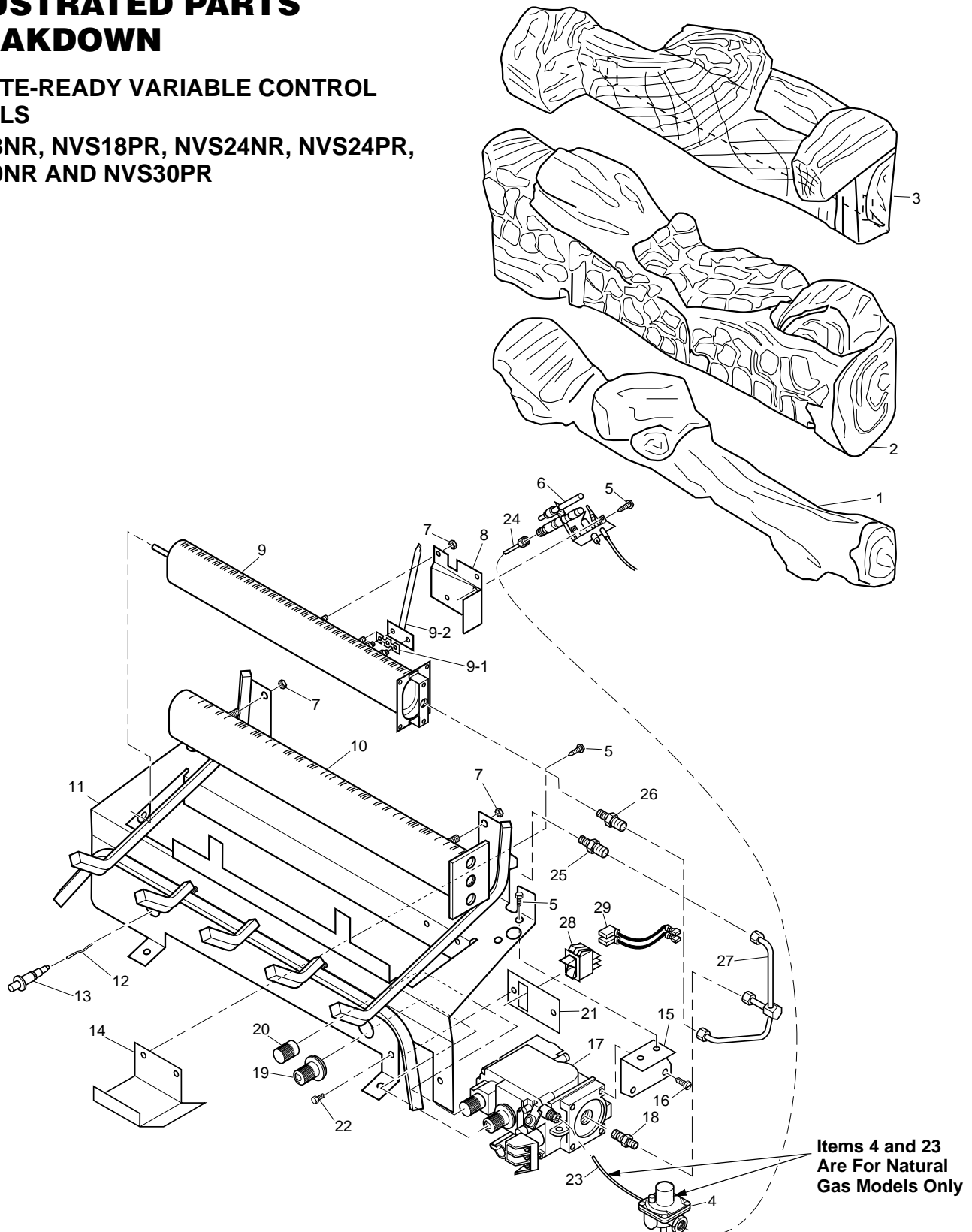

For more information, visit www.desatech.com

PARTS LIST

REMOTE-READY VARIABLE CONTROL

This list contains replaceable parts used in your heater. When ordering parts, follow the instructions listed under *Replacement Parts* on page 29 of this manual.

KEY NO.	PART NUMBERS						DESCRIPTION	QTY.
	NVS18NR	NVS18PR	NVS24NR	NVS24PR	NVS30NR	NVS30PR		
1	110881-01	110880-01	110881-04	110881-04	110881-07	110881-07	Front Log (#1)	1
2	110881-02	110881-02	110881-05	110881-05	110881-08	110881-08	Middle Log (#2)	1
3	110881-03	110881-03	110881-06	110881-06	110881-09	110881-09	Rear Log (#3)	1
4	099918-02	—	099918-02	—	099918-02	—	Pilot Regulator	1
5	M11084-26	M11084-26	M11084-26	M11084-26	M11084-26	M11084-26	Screw	6
6	103779-01	103778-01	103779-01	103778-01	103779-01	103778-01	O.D.S. Pilot	1
7	098249-01	098249-01	098249-01	098249-01	098249-01	098249-01	Nut	6
8	103780-01	103780-01	103780-01	103780-01	103780-01	103780-01	Pilot Bracket	1
9	101330-01	101330-01	101330-05	101330-05	101330-06	101330-06	Front Burner Assembly	1
9-1	101008-01	101008-01	101008-01	101008-01	101008-01	101008-01	Crossover Burner Gasket	1
9-2	101007-01	101007-01	101007-01	101007-01	101007-01	101007-01	Crossover Burner	1
10	100999-04	100999-01	109824-02	100999-02	100999-06	109824-03	Rear Burner Assembly	1
11	101331-11	101331-11	101331-12	101331-12	101331-13	101331-13	Base Assembly with Decals	1
12	098271-10	098271-10	098271-06	098271-06	098271-06	098271-06	Ignitor Cable	1
13	102445-01	102445-01	102445-01	102445-01	102445-01	102445-01	Piezo Ignitor	1
14	103588-01	103588-01	103588-01	103588-01	103588-01	103588-01	Heat Shield	1
15	103782-01	103782-01	103782-01	103782-01	103782-01	103782-01	Valve Bracket	1
16	M12461-26	M12461-26	M12461-26	M12461-26	M12461-26	M12461-26	Screw	5
17	103781-01	103781-02	103781-01	103781-02	103781-01	103781-02	Gas Control	1
18	098264-02	098264-02	098264-02	098264-02	098264-02	097264-02	Male Fitting	1
19	103784-02	103784-02	103784-02	103784-02	103784-02	103784-02	Flame Adjustment Knob	1
20	103784-01	103784-01	103784-01	103784-01	103784-01	103784-01	Control Knob	1
21	103587-01	103587-01	103587-01	103587-01	103587-01	103587-01	Switch Plate	1
22	M11084-26	M11084-26	M11084-26	M11084-26	M11084-26	M11084-26	Screw	2
23	099387-12	—	099387-12	—	099387-12	—	Pilot Tube	1
24	100609-01	099387-09	100609-01	099387-09	100609-01	099387-09	Pilot Tube	1
25	101004-11	101004-10	101004-11	101004-01	101004-04	101004-02	Rear Burner Injector	1
26	101004-11	101004-10	101004-08	101004-02	101004-08	101004-06	Front Burner injector	1
27	103783-01	103783-01	103783-01	103783-01	103783-01	103783-01	Remote Burner Tube	1
28	099998-01	099998-01	099998-01	099998-01	099998-01	099998-01	Switch	1
29	103284-02	103284-02	103284-02	103284-02	103284-02	103284-02	Wiring Harness	1
PARTS AVAILABLE — NOT SHOWN								
	100563-01	100563-01	100563-01	100563-01	100563-01	100563-01	Warning Plate	1
	103877-01	103877-01	103877-01	103877-01	103877-01	103877-01	Lighting Instructions Plate	1
	100565-01	100565-01	100565-01	100565-01	100565-01	100565-01	Warning Plate Fastener	1
	100639-01	100639-01	100639-01	100639-01	100639-01	100639-01	Caution Decal	1
	101137-02	101137-02	101137-02	101137-02	101137-02	101137-02	Hardware Kit	1
	GA6060	GA6060	GA6060	GA6060	GA6060	GA6060	Lava Rock	1

ACCESSORIES

Purchase these heater accessories from your local dealer. If they can not supply these accessories, call DESA Heating Products at 1-866-672-6040 for referral information. You can also write to the address listed on the back page of this manual.

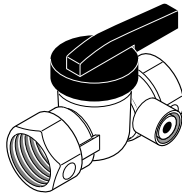

EQUIPMENT SHUTOFF VALVE - GA5010

For all models. Equipment shutoff valve with 1/8" NPT tap. Fits 1/2" NPT pipe.

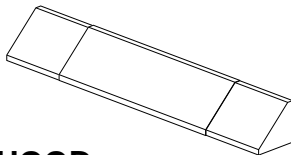

FIREPLACE HOOD

Black - GA6050

Brass - GA6052

Antique Brass - GA6053

For all models. Helps deflect heat away from mantel or wall above fireplace. Fits openings 28" to 48" wide.

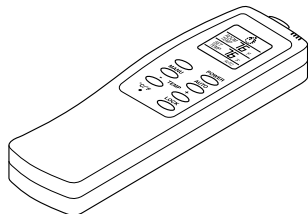

RECEIVER AND HAND-HELD THERMOSTAT REMOTE CONTROL KIT - GHRCTB

For all Remote-Ready Models. Allows the fireplace to be operated in a manually or thermostatically controlled mode. You can turn the fireplace on and off without ever leaving the comfort of your easy chair.

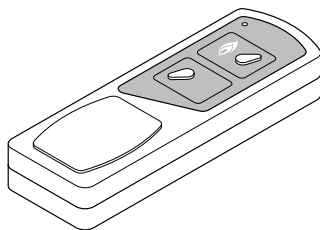

RECEIVER AND HAND-HELD REMOTE CONTROL KIT - GHRCB

For all Remote-Ready Models. Allows the fireplace to be turned on and off by using a hand-held remote control.

WALL-MOUNT THERMOSTAT SWITCH - GWMT1 (Not Shown)

For all Remote-Ready Models. The desired comfort setting can be selected on the wall thermostat and the log heater will automatically cycle from pilot to the heat setting selected.

WALL-MOUNT ON/OFF SWITCH - GWMS2 (Not Shown)

For all Remote-Ready Models. Allows the gas log heater to be turned on and off with a wall switch.

VENT-FREE LOGMATE® FIREBOXES (Not Shown)

Available in 32", 36", and 42" models. Circulating fireboxes feature louvers and an optional blower. Non-circulating, smooth face models are ideal for custom trim applications such as stone or marble.

FB32C (CIRCULATING), FB32NC (NON-CIRCULATING) SERIES (Not Shown)

For 18" and 24" models.

FB36CA, FB42C SERIES (CIRCULATING), FB36NCA, FB42NC SERIES (NON-CIRCULATING) (Not Shown)

For all models.

DAMPER CLAMP - GA6080 (Not Shown)

For Remote-Ready and Variable Manually-Controlled Models. Permanently opens chimney flue damper for vented operation.

LAVA ROCK - GA6060 (Not Shown)

For all models. Order when additional rock is desired. (1.8 lb. bag)

CLEANING KIT - GCK (Not Shown)

For all models. Your vent-free gas appliance requires regular cleaning and maintenance to prevent performance problems. This kit gives you the tools and instructions to make it easy to clean all critical areas of your appliance.

INFORMATION VIDEO - 108917-01

For all models. A care and maintenance video is available by calling 1-866-672-6040. You may also email your request to productsupport@desaint.com.

FIRE CRACKLE - CF6-A (Not Shown)

For all models. Creates the sound of a real burning fire.

For more information, visit www.desatech.com

OWNER'S REGISTRATION FORM

In order to provide better customer service for this and future purchases, we recommend that you register your product with us. You can register online at www.desatech.com. If access to our website is not available to you, please complete this Owner's Registration Form and mail to the address on the back of this owner's manual. Please provide the following product information:

Brand: _____ (Comfort Glow, Vanguard, etc.)
 Model: _____ (EFP33PR, VTGH33NR, etc.)
 Date Purchased: _____ Note: Keep receipt for warranty verification.
 Serial Number: _____ 7 or 9 digit number located on product or identification tag.
 First Name: _____ Last Name: _____
 Address: _____
 City: _____ State: _____ Zip: _____ Country: _____
 Home Phone: (____) _____ - _____
 E-Mail: _____

Please answer the following questions to register your product with DESA Heating Products:

1. Where will the product be used?
 Living/Family Room Office/Warehouse Utility Shed/Outbuilding Garage Bedroom Bathroom Other
2. If you bought this product yourself, did you plan to purchase this type of product before going into the store? Yes No
3. Who selected the product? Male Female Both
4. What is the population of your area? Under 10,000 10,000 to 25,000 25,000 to 50,000 50,000 to 100,000
 100,000 to 250,000 Over 250,000
5. What is your primary source of heat? Propane (LP Gas) Fuel Oil Wood Natural Gas Electric Other
6. How was the product installed? Professional Installer Self Other
7. Cost of product excluding sales tax? \$ _____
8. Cost to install product? \$ _____
9. Type of store where product was purchased? Hardware Propane Dealer Natural Gas/Utility Co. Home Center/Builder's Supply
 Fireplace or Hearth Shop Farm Store Other
10. What motivated you to buy this product? Sudden Cold Weather Replace Older Model D.I.Y. Home Project
 Emergency Back-Up Heat Heater was on Sale Energy Savings/High Efficiency Construction Project Other
11. How did you learn about this product brand? Advertising Relative or Friend Store Display Other _____
12. Level of Education of Purchaser: Some High School Completed High School Completed College Completed Graduate School
13. Age of Purchaser: Under 20 20 - 29 30 - 39 40 - 49 50 - 59 60 or Over
14. Buyer's total annual household income: Under \$15,000 \$15,000 to \$19,999 \$20,000 to \$34,999 \$35,000 to \$49,999
 \$50,000 to \$74,999 \$75,000 to \$99,999 \$100,000 and Over
15. Store where product was purchased:
 Name: _____
 City: _____ State: _____

16. In choosing this product, how important were the following:

	Not Important	Somewhat Important	Very Important
Availability	<input type="radio"/>	<input type="radio"/>	<input type="radio"/>
Price	<input type="radio"/>	<input type="radio"/>	<input type="radio"/>
Brand Name	<input type="radio"/>	<input type="radio"/>	<input type="radio"/>
Overall Quality	<input type="radio"/>	<input type="radio"/>	<input type="radio"/>
Heat Output	<input type="radio"/>	<input type="radio"/>	<input type="radio"/>
Made in USA	<input type="radio"/>	<input type="radio"/>	<input type="radio"/>
Warranty	<input type="radio"/>	<input type="radio"/>	<input type="radio"/>
Local Service	<input type="radio"/>	<input type="radio"/>	<input type="radio"/>
Value for Price	<input type="radio"/>	<input type="radio"/>	<input type="radio"/>
Prior Brand Experience	<input type="radio"/>	<input type="radio"/>	<input type="radio"/>
Controls Location	<input type="radio"/>	<input type="radio"/>	<input type="radio"/>
Thermostat, Remote, or Manual Operation	<input type="radio"/>	<input type="radio"/>	<input type="radio"/>
Ease of Operation	<input type="radio"/>	<input type="radio"/>	<input type="radio"/>
Special Features	<input type="radio"/>	<input type="radio"/>	<input type="radio"/>
Salesperson's Recommendation	<input type="radio"/>	<input type="radio"/>	<input type="radio"/>
Friend/Relative's Recommendation	<input type="radio"/>	<input type="radio"/>	<input type="radio"/>
Portability	<input type="radio"/>	<input type="radio"/>	<input type="radio"/>
Quiet Operation	<input type="radio"/>	<input type="radio"/>	<input type="radio"/>

TAPE

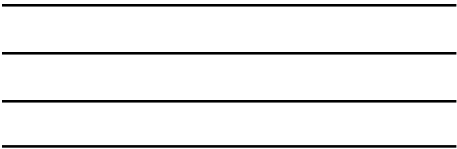

Postage
Required

DESATM
HEATING PRODUCTS
2701 Industrial Drive
P.O. Box 90004
Bowling Green, KY 42102-9004

WARRANTY INFORMATION

KEEP THIS WARRANTY

Model _____
Serial No. _____
Date Purchased _____

Always specify model and serial numbers when communicating with the factory.

We reserve the right to amend these specifications at any time without notice. The only warranty applicable is our standard written warranty. We make no other warranty, expressed or implied.

LIMITED WARRANTY VENT-FREE GAS LOG HEATERS

DESA Heating Products warrants this product to be free from defects in materials and components for four (4) years and five (5) years on stainless steel burners from the date of first purchase, provided that the product has been properly installed, operated and maintained in accordance with all applicable instructions. To make a claim under this warranty the Bill of Sale or cancelled check must be presented.

This warranty is extended only to the original retail purchaser. This warranty covers the cost of part(s) required to restore this heater to proper operating condition and an allowance for labor when provided by a DESA Heating Products Authorized Service Center. Warranty part(s) MUST be obtained through authorized dealers of this product and/or DESA Heating Products who will provide original factory replacement parts. Failure to use original factory replacement parts voids this warranty. The heater MUST be installed by a qualified installer in accordance with all local codes and instructions furnished with the unit.

This warranty does not apply to parts that are not in original condition because of normal wear and tear, or parts that fail or become damaged as a result of misuse, accidents, lack of proper maintenance or defects caused by improper installation. Travel, diagnostic cost, labor, transportation and any and all such other costs related to repairing a defective heater will be the responsibility of the owner.

TO THE FULL EXTENT ALLOWED BY THE LAW OF THE JURISDICTION THAT GOVERNS THE SALE OF THE PRODUCT; THIS EXPRESS WARRANTY EXCLUDES ANY AND ALL OTHER EXPRESSED WARRANTIES AND LIMITS THE DURATION OF ANY AND ALL IMPLIED WARRANTIES, INCLUDING WARRANTIES OF MERCHANTABILITY AND FITNESS FOR A PARTICULAR PURPOSE TO FOUR (4) YEARS ON ALL COMPONENTS AND FIVE (5) YEARS ON STAINLESS STEEL BURNERS FROM THE DATE OF FIRST PURCHASE; AND DESA HEATING PRODUCTS' LIABILITY IS HEREBY LIMITED TO THE PURCHASE PRICE OF THE PRODUCT AND DESA HEATING PRODUCTS SHALL NOT BE LIABLE FOR ANY OTHER DAMAGES WHATSOEVER INCLUDING INDIRECT, INCIDENTAL OR CONSEQUENTIAL DAMAGES.

Some states do not allow a limitation on how long an implied warranty lasts or an exclusion or limitation of incidental or consequential damages, so the above limitation on implied warranties, or exclusion or limitation on damages may not apply to you.

This warranty gives you specific legal rights, and you may also have other rights that vary from state to state.

For information about this warranty write:

DESATM
HEATING PRODUCTS
2701 Industrial Drive
P.O. Box 90004
Bowling Green, KY 42102-9004
www.desatech.com



110882 01

NOT A UPC

110882-01
Rev. C
04/03

For more information, visit www.desatech.com

Free Manuals Download Website

<http://myh66.com>

<http://usermanuals.us>

<http://www.somanuals.com>

<http://www.4manuals.cc>

<http://www.manual-lib.com>

<http://www.404manual.com>

<http://www.luxmanual.com>

<http://aubethermostatmanual.com>

Golf course search by state

<http://golfingnear.com>

Email search by domain

<http://emailbydomain.com>

Auto manuals search

<http://auto.somanuals.com>

TV manuals search

<http://tv.somanuals.com>