

DESA™

INDOOR/OUTDOOR PRODUCTS

UNVENTED (VENT-FREE) BLUE FLAME GAS HEATER SAFETY INFORMATION AND INSTALLATION MANUAL

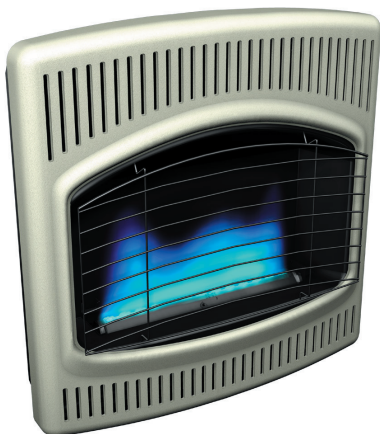

We recommend that our products be installed and serviced by professionals who are certified in the U.S. by NFI (National Fireplace Institute).
www.nficertified.org

MODELS CBN20T, CBP20T, CBN30T, CBP30T, CBT20NT, CBT20PT, CBT30NT AND CBT30PT

WARNING: If the information in this manual is not followed exactly, a fire or explosion may result causing property damage, personal injury or loss of life.

- Do not store or use gasoline or other flammable vapors and liquids in the vicinity of this or any other appliance.
- **WHAT TO DO IF YOU SMELL GAS**
 - Do not try to light any appliance.
 - Do not touch any electrical switch; do not use any phone in your building.
 - Immediately call your gas supplier from a neighbor's phone. Follow the gas supplier's instructions.
 - If you cannot reach your gas supplier, call the fire department.
- Installation and service must be performed by a qualified installer, service agency or the gas supplier.

Save this manual for future reference.

For more information, visit www.desatech.com

Download from www.Somanuals.com. All Manuals Search And Download.

WARNING: Improper installation, adjustment, alteration, service or maintenance can cause injury or property damage. Refer to this manual for correct installation and operational procedures. For assistance or additional information consult a qualified installer, service agency or the gas supplier.

WARNING: This is an unvented gas-fired heater. It uses air (oxygen) from the room in which it is installed. Provisions for adequate combustion and ventilation air must be provided. Refer to *Air for Combustion and Ventilation* section on page 5 of this manual.

This appliance may be installed in an aftermarket,* permanently located, manufactured (mobile) home, where not prohibited by local codes.

This appliance is only for use with the type of gas indicated on the rating plate. This appliance is not convertible for use with other gases.

* Aftermarket: Completion of sale, not for purpose of resale, from the manufacturer

State of Massachusetts: The installation must be made by a licensed plumber or gas fitter in the Commonwealth of Massachusetts.

Sellers of unvented propane or natural gas-fired supplemental room heaters shall provide to each purchaser a copy of 527 CMR 30 upon sale of the unit.

Vent-free gas products are prohibited for bedroom and bathroom installation in the Commonwealth of Massachusetts.

TABLE OF CONTENTS

Safety Information	3	Service Hints	17
Local Codes	4	Technical Service	17
Product Identification	4	Troubleshooting	18
Unpacking	4	Specifications	22
Product Features	4	Replacement Parts	23
Air For Combustion and Ventilation	5	Service Publications	23
Installation	7	Illustrated Parts Breakdown and Parts List	24
Operating Heater	14	Accessories	26
Inspecting Heater	15	Parts Central	27
Cleaning and Maintenance	16	Warranty Information	Back Cover

SAFETY INFORMATION

 **WARNING:** This product contains and/or generates chemicals known to the State of California to cause cancer or birth defects or other reproductive harm.

IMPORTANT: Read this owner's manual carefully and completely before trying to assemble, operate or service this heater. Improper use of this heater can cause serious injury or death from burns, fire, explosion, electrical shock and carbon monoxide poisoning.

 **DANGER:** Carbon monoxide poisoning may lead to death!

Carbon Monoxide Poisoning: Early signs of carbon monoxide poisoning resemble the flu, with headaches, dizziness or nausea. If you have these signs, the heater may not be working properly. **Get fresh air at once!** Have heater serviced. Some people are more affected by carbon monoxide than others. These include pregnant women, people with heart or lung disease or anemia, those under the influence of alcohol and those at high altitudes.

Natural and Propane/LP Gas: Natural and Propane/LP gases are odorless. An odor-making agent is added to these gases. The odor helps you detect a gas leak. However, the odor added to the gas can fade. Gas may be present even though no odor exists.

Make certain you read and understand all warnings. Keep this manual for reference. It is your guide to safe and proper operation of this heater.

 **WARNING:** Any change to this heater or its controls can be dangerous.

 **WARNING:** Do not use a blower insert, heat exchanger insert or other accessory not approved for use with this heater.

Due to high temperatures, the appliance should be located out of traffic and away from furniture and draperies.

Do not place clothing or other flammable material on or near the appliance. Never place any objects on the heater.

Surface of heater becomes very hot when running heater. Keep children and adults away from hot surface to avoid burns or clothing ignition. Heater will remain hot for a time after shut-down. Allow surface to cool before touching.

Carefully supervise young children when they are in the same room with heater.

Make sure grill guard is in place before running heater.

Keep the appliance area clear and free from combustible materials, gasoline and other flammable vapors and liquids.

1. This appliance is only for use with the type of gas indicated on the rating plate. This appliance is not convertible for use with other gases.
2. Do not place propane/LP supply tank(s) inside any structure. Locate propane/LP supply tank(s) outdoors.
3. This heater shall not be installed in a bedroom or bathroom.
4. If you smell gas
 - Shut off gas supply
 - Do not try to light any appliance
 - Do not touch any electrical switch; do not use any phone in your building
 - Immediately call your gas supplier from a neighbor's phone. Follow the gas supplier's instructions
 - If you cannot reach your gas supplier, call the fire department

SAFETY INFORMATION

Continued

- This heater needs fresh, outside air ventilation to run properly. This heater has an Oxygen Depletion Sensing (ODS) safety shutoff system. The ODS shuts down the heater if not enough fresh air is available. See *Air for Combustion and Ventilation*, page 5.
- Keep all air openings in front and bottom of heater clear and free of debris. This will insure enough air for proper combustion.
- If heater shuts off, do not relight until you provide fresh, outside air. If heater keeps shutting off, have it serviced.
- Do not run heater
 - where flammable liquids or vapors are used or stored
 - under dusty conditions
- Do not use heater if any part has been under water. Immediately call a qualified service technician to inspect the room heater and to replace any part of the control system and any gas control which has been under water.
- Turn off and let cool before servicing. Only a qualified service person should service and repair heater.
- Operating heater above elevations of 4,500 feet (1,371 m) could cause pilot outage.
- To prevent performance problems, do not use propane/LP fuel tank of less than 100 lbs. (45 kg) capacity.
- Before using furniture polish, wax, carpet cleaner or similar products, turn heater off. If heated, the vapors from these products may create a white powder residue within burner box or on adjacent walls or furniture.
- Provide adequate clearances around air openings.

LOCAL CODES

Install and use heater with care. Follow all local codes. In the absence of local codes, use the latest edition of *The National Fuel Gas Code, ANSI Z223.1/NFPA 54**.

*Available from:

American National Standards Institute, Inc.
1430 Broadway
New York, NY 10018

National Fire Protection Association, Inc.
Batterymarch Park
Quincy, MA 02269

PRODUCT IDENTIFICATION

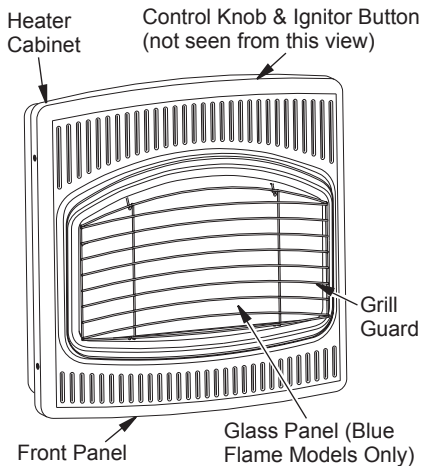

Figure 1 - Vent-Free Gas Heater

UNPACKING

- Remove heater from carton.
- Remove all protective packaging applied to heater for shipment.
- Check heater for any shipping damage. If heater is damaged, promptly return to where you bought heater.

PRODUCT FEATURES

SAFETY DEVICE

This heater has a pilot with an Oxygen Depletion Sensing (ODS) safety shutoff system. The ODS/pilot is a required feature for vent-free room heaters. The ODS/pilot shuts off the heater if there is not enough fresh air.

IGNITION SYSTEM

This heater has either a piezo ignitor or electronic ignitor to light heater fuel supply.

THERMOSTATIC HEAT CONTROL

Thermostat models have a thermostat sensing bulb and a control valve. This results in the greatest heater comfort. This can also result in lower gas bills.

AIR FOR COMBUSTION AND VENTILATION

⚠ WARNING: This heater shall not be installed in a confined space or unusually tight construction unless provisions are provided for adequate combustion and ventilation air. Read the following instructions to insure proper fresh air for this and other fuel-burning appliances in your home.

Today's homes are built more energy efficient than ever. New materials, increased insulation and new construction methods help reduce heat loss in homes. Home owners weather strip and caulk around windows and doors to keep the cold air out and the warm air in. During heating months, home owners want their homes as airtight as possible.

While it is good to make your home energy efficient, your home needs to breathe. Fresh air must enter your home. All fuel-burning appliances need fresh air for proper combustion and ventilation.

Exhaust fans, fireplaces, clothes dryers and fuel burning appliances draw air from the house to operate. You must provide adequate fresh air for these appliances. This will insure proper venting of vented fuel-burning appliances.

PROVIDING ADEQUATE VENTILATION

The following are excerpts from *National Fuel Gas Code, ANSI Z223.1/NFPA 54, Section 5.3, Air for Combustion and Ventilation*.

All spaces in homes fall into one of the three following ventilation classifications:

1. Unusually Tight Construction
2. Unconfined Space
3. Confined Space

The information on pages 5 through 7 will help you classify your space and provide adequate ventilation.

Unusually Tight Construction

The air that leaks around doors and windows may provide enough fresh air for combustion and ventilation. However, in buildings of unusually tight construction, you must provide additional fresh air.

Unusually tight construction is defined as construction where:

- a. walls and ceilings exposed to the outside atmosphere have a continuous water vapor retarder with a rating of one perm (6×10^{-11} kg per pa-sec- m^2) or less with openings gasketed or sealed and
- b. weather stripping has been added on openable windows and doors and
- c. caulking or sealants are applied to areas such as joints around window and door frames, between sole plates and floors, between wall-ceiling joints, between wall panels, at penetrations for plumbing, electrical and gas lines and at other openings.

If your home meets all of these three criteria, you must provide additional fresh air. See *Ventilation Air From Outdoors*, page 7.

If your home does not meet all of the three criteria above, proceed to *Determining Fresh-Air Flow For Heater Location*, page 6.

Confined and Unconfined Space

The National Fuel Gas Code, ANSI Z223.1/NFPA 54 defines a confined space as a space whose volume is less than 50 cubic feet per 1,000 Btu per hour (4.8 m^3 per kw) of the aggregate input rating of all appliances installed in that space and an unconfined space as a space whose volume is not less than 50 cubic feet per 1,000 Btu per hour (4.8 m^3 per kw) of the aggregate input rating of all appliances installed in that space. Rooms communicating directly with the space in which the appliances are installed*, through openings not furnished with doors, are considered a part of the unconfined space.

* Adjoining rooms are communicating only if there are doorless passageways or ventilation grills between them.

AIR FOR COMBUSTION AND VENTILATION

Continued

DETERMINING FRESH-AIR FLOW FOR HEATER LOCATION

Determining if You Have a Confined or Unconfined Space

Use this work sheet to determine if you have a confined or unconfined space.

Space: Includes the room in which you will install heater plus any adjoining rooms with doorless passageways or ventilation grills between the rooms.

1. Determine the volume of the space (length x width x height).

Length x Width x Height = _____ cu. ft.
(volume of space)

Example: Space size 20 ft. (6.1 m) (length) x 16 ft. (4.88 m) (width) x 8 ft. (2.44 m) (ceiling height) = 2560 cu. ft. (72.49 m³) (volume of space)

If additional ventilation to adjoining room is supplied with grills or openings, add the volume of these rooms to the total volume of the space.

2. Multiply the space volume by 20 to determine the maximum Btu/Hr the space can support.

_____ (volume of space) x 20 = (Maximum Btu/Hr the space can support)

Example: 2560 cu. ft. (72.49 m³) (volume of space) x 20 = 51,200 (maximum Btu/Hr the space can support)

3. Add the Btu/Hr of all fuel burning appliances in the space.

Vent-free heater	_____ Btu/Hr
Gas water heater*	_____ Btu/Hr
Gas furnace	_____ Btu/Hr
Vented gas heater	_____ Btu/Hr
Gas fireplace logs	_____ Btu/Hr
Other gas appliances* +	_____ Btu/Hr
Total	= _____ Btu/Hr

* Do not include direct-vent gas appliances. Direct-vent draws combustion air from the outdoors and vents to the outdoors.

Example:

Gas water heater	_____ 40,000 Btu/Hr
Vent-free heater	+ _____ 20,000 Btu/Hr
Total	= _____ 60,000 Btu/Hr

4. Compare the maximum Btu/Hr the space can support with the actual amount of Btu/Hr used.

_____ Btu/Hr (maximum the space can support)

_____ Btu/Hr (actual amount of Btu/Hr used)

Example: 51,200 Btu/Hr (maximum the space can support)

60,000 Btu/Hr (actual amount of Btu/Hr used)

The space in the above example is a confined space because the actual Btu/Hr used is more than the maximum Btu/Hr the space can support. You must provide additional fresh air. Your options are as follows:

- A. Rework worksheet, adding the space of an adjoining room. If the extra space provides an unconfined space, remove door to adjoining room or add ventilation grills between rooms. See *Ventilation Air From Inside Building*.
- B. Vent room directly to the outdoors. See *Ventilation Air From Outdoors*, page 7.
- C. Install a lower Btu/Hr heater, if lower Btu/Hr size makes room unconfined.

If the actual Btu/Hr used is less than the maximum Btu/Hr the space can support, the space is an unconfined space. You will need no additional fresh air ventilation.

 **WARNING:** If the area in which the heater may be operated is smaller than that defined as an unconfined space or if the building is of unusually tight construction, provide adequate combustion and ventilation air by one of the methods described in the *National Fuel Gas Code, ANSI Z223.1/NFPA 54 Section 5.3* or applicable local codes.

VENTILATION AIR

Ventilation Air From Inside Building

This fresh air would come from an adjoining unconfined space. When ventilating to an adjoining unconfined space, you must provide two permanent openings: one within 12" (30.4 cm) of the ceiling and one within 12" (30.4 cm) of the floor on the wall connecting the two spaces (see options 1 and 2, Figure 2, page 7). You can also remove door into adjoining room (see option 3, Figure 2, page 7). Follow the *National Fuel Gas Code, ANSI Z223.1/NFPA 54, Section 5.3, Air for Combustion and Ventilation* for required size of ventilation grills or ducts.

AIR FOR COMBUSTION AND VENTILATION

Continued

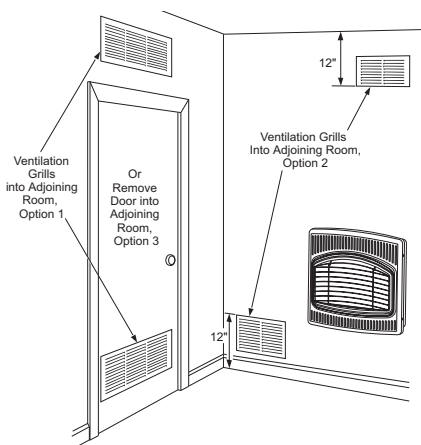

Figure 2 - Ventilation Air from Inside Building

Ventilation Air From Outdoors

Provide extra fresh air by using ventilation grills or ducts. You must provide two permanent openings: one within 12" (30.4 cm) of the ceiling and one within 12" (30.4 cm) of the floor. Connect these items directly to the outdoors or spaces open to the outdoors. These spaces include attics and crawl spaces. Follow the *National Fuel Gas Code, ANSI Z223.1/NFPA 54, Section 5.3, Air for Combustion and Ventilation* for required size of ventilation grills or ducts.

IMPORTANT: Do not provide openings for inlet or outlet air into attic if attic has a thermostat-controlled power vent. Heated air entering the attic will activate the power vent.

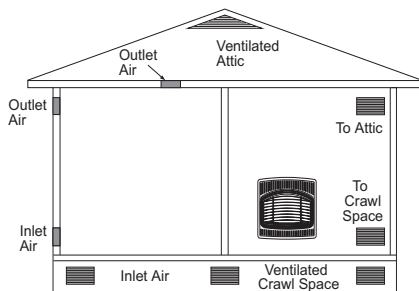

Figure 3 - Ventilation Air from Outdoors

INSTALLATION

NOTICE: This heater is intended for use as supplemental heat. Use this heater along with your primary heating system. Do not install this heater as your primary heat source. If you have a central heating system, you may run system's circulating blower while using heater. This will help circulate the heat throughout the house. In the event of a power outage, you can use this heater as your primary heat source.

WARNING: A qualified service person must install heater. Follow all local codes.

CHECK GAS TYPE

Use only the correct type of gas (natural or propane/LP). If your gas supply is not the correct gas type, do not install heater. Call dealer where you bought heater for proper type heater.

WARNING: This appliance is equipped for (natural or propane/LP) gas. Field conversion is not permitted.

INSTALLATION ITEMS

Before installing heater, make sure you have the items listed below.

- for propane/LP gas, external regulator (supplied by installer)
- piping (check local codes)
- sealant (resistant to propane/LP gas)
- equipment shutoff valve *
- ground joint union
- sediment trap
- tee joint
- pipe wrench
- for natural gas, test gauge connection*

* A CSA design-certified equipment shutoff valve with 1/8" NPT tap is an acceptable alternative to test gauge connection. The optional CSA design-certified equipment shutoff valve can be purchased from your dealer. See *Accessories*, page 26.

INSTALLATION

Continued

LOCATING HEATER

WARNING: Maintain the minimum clearances shown in Figure 4. If you can, provide greater clearances from floor, ceiling and joining wall.

A wall mounting bracket is included with this heater. An Optional Base Kit (GA4550) may be purchased to allow the unit to be installed away from a wall (see *Accessories*, page 26). Determine which method is best for your application.

WARNING: Never install the heater

- in a bedroom or bathroom
- in a recreational vehicle
- where curtains, furniture, clothing or other flammable objects are less than 36 inches (91.5 cm) from the front, top or sides of the heater
- as a fireplace insert
- in high traffic areas
- in windy or drafty areas

CAUTION: If you install the heater in a home garage

- heater pilot and burner must be at least 18 inches (45.7 cm) above floor
- locate heater where moving vehicle will not hit it

CAUTION: This heater creates warm air currents. These currents move heat to wall surfaces next to heater. Installing heater next to vinyl or cloth wall coverings or operating heater where impurities (such as, but not limited to, tobacco smoke, aromatic candles, cleaning fluids, oil or kerosene lamps, etc.) in the air exist, may discolor walls or cause odors.

IMPORTANT: Vent-free heaters add moisture to the air. Although this is beneficial, installing heater in rooms without enough ventilation air may cause mildew to form from too much moisture. See *Air for Combustion and Ventilation*, page 5. If high humidity is experienced, a dehumidifier may be used to help lower the water vapor content in the air.

For convenience and efficiency, install heater

- where there is easy access for operation, inspection and service
- in coldest part of room

An optional fan kit is available from your dealer. See *Accessories*, page 26. If planning to use fan, locate heater near an electrical outlet.

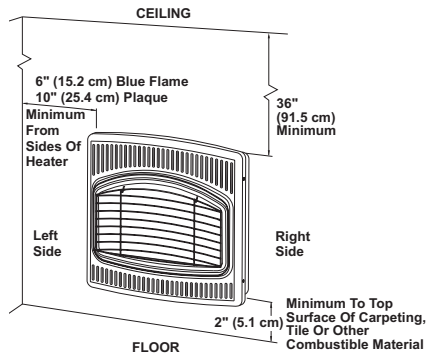

Figure 4 - Mounting Clearances As Viewed From Front of Heater

THERMOSTAT SENSING BULB

The thermostat sensing bulb is below the heater.

1. Place clamp on thermostat sensing bulb as shown in Figure 5. Clamp is provided in hardware package.
2. Snap clamp into upper mounting hole as shown in Figure 5. Mounting hole is located on lower left edge on back of heater. Make sure the thermostat sensing bulb is pointing up.

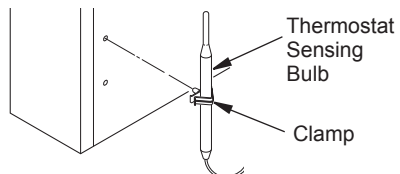

Figure 5 - Attaching Thermostat Sensing Bulb

INSTALLATION

Continued

INSTALLING HEATER TO WALL

Mounting Bracket

Locate mounting bracket in heater carton. Remove mounting bracket from heater carton.

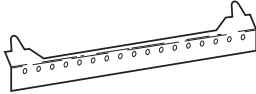

Figure 6 - Mounting Bracket

Removing Front Panel Of Heater

1. Remove the four painted screws, two on each side of front panel.
2. Pull bottom of front panel forward, then out.
3. Remove any remaining packaging materials.

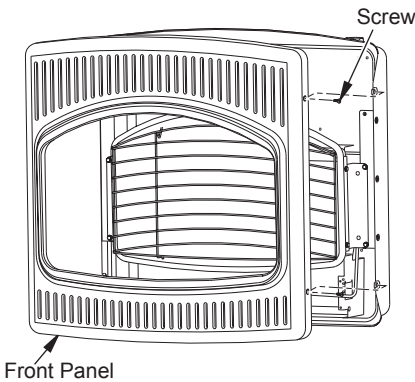

Figure 7 - Removing Front Panel Of Heater

Methods For Attaching Mounting Bracket To Wall

Only use last hole on each end of mounting bracket to attach bracket to wall. These two holes are 14" (35.6 cm) apart from their centers. Attach mounting bracket to wall in one of two ways:

1. Attaching to wall stud
2. Attaching to wall anchor

Attaching to Wall Stud: This method provides the strongest hold. Insert mounting screws through mounting bracket and into wall studs.

Attaching to Wall Anchor: This method allows you to attach mounting bracket to hollow walls (wall areas between studs) or to solid walls (concrete or masonry).

Decide which method better suits your needs. Either method will provide a secure hold for the mounting bracket.

Marking Screw Locations

1. Tape mounting bracket to wall where heater will be located. Make sure mounting bracket is level.



WARNING: Maintain minimum clearances shown in Figure 8. If you can, provide greater clearances from floor and joining wall.

2. Mark screw locations on wall (see Figure 8).
Note: Only mark last hole on each end of mounting bracket. Insert mounting screws through these holes only.
3. Remove tape and mounting bracket from wall.

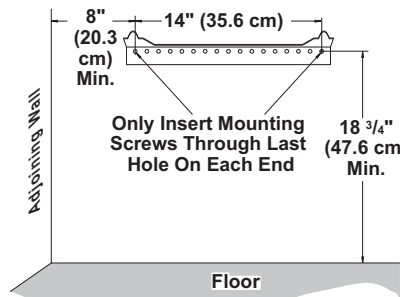

20,000 Btu/hr Models

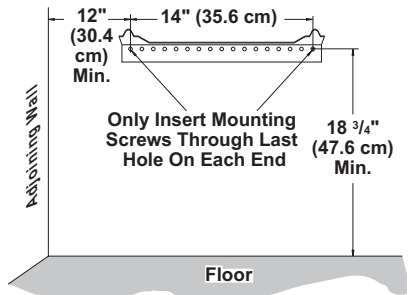

30,000 Btu/hr Models

Figure 8 - Mounting Bracket Clearances

Attaching Mounting Bracket To Wall

Note: Wall anchors, mounting screws and spacers are in hardware package. The hardware package is provided with heater.

INSTALLATION

Continued

Attaching To Wall Stud Method

For attaching mounting bracket to wall studs

1. Drill holes at marked locations using 9/64" drill bit.
2. Place mounting bracket onto wall. Line up last hole on each end of bracket with holes drilled in wall.
3. Insert mounting screws through bracket and into wall studs.
4. Tighten screws until mounting bracket is firmly fastened to wall studs.

Attaching To Wall Anchor Method

For attaching mounting bracket to hollow walls (wall areas between studs) or solid walls (concrete or masonry)

1. Drill holes at marked locations using 5/16" drill bit. For solid walls (concrete or masonry), drill at least 1" (2.5 cm) deep.
2. Fold wall anchor as shown in Figure 9.
3. Insert wall anchor (wings first) into hole. Tap anchor flush to wall.
4. For thin walls [1/2" (1.3 cm) or less], insert red key into wall anchor. Push red key to "pop" open anchor wings. **IMPORTANT:** Do not hammer key! For thick walls [over 1/2" (1.3 cm) thick] or solid walls, do not pop open wings.
5. Place mounting bracket onto wall. Line up last hole on each end of bracket with wall anchors.
6. Insert mounting screws through bracket and into wall anchors.
7. Tighten screws until mounting bracket is firmly fastened to wall.

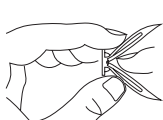

Figure 9 - Folding Anchor

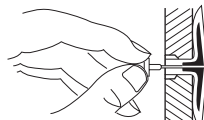

Figure 10 - Popping Open Anchor Wings For Thin Walls

Placing Heater On Mounting Bracket

1. Locate two horizontal slots on back panel of heater.
2. Place heater onto mounting bracket. Slide horizontal slots onto stand-out tabs on mounting bracket.

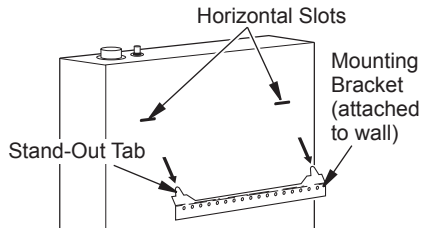

Figure 11 - Mounting Heater Onto Mounting Bracket

Installing Bottom Mounting Screws

1. Locate two bottom mounting holes. These holes are near bottom on back panel of heater (see Figure 12).
 2. Mark screw locations on wall.
 3. Remove heater from mounting bracket.
 4. If installing bottom mounting screws into hollow or solid wall, install wall anchors. Follow steps 1 through 4 under *Attaching To Wall Anchor Method*.
- If installing bottom mounting screw into wall stud, drill holes at marked locations using 9/64" drill bit.
5. Replace heater onto mounting bracket.
 6. Place spacers between bottom mounting holes and wall anchor or drilled hole.
 7. Hold spacer in place with one hand. With other hand, insert mounting screw through bottom mounting hole and spacer. Place tip of screw in opening of wall anchor or drilled hole.
 8. Tighten both screws until heater is firmly secured to wall. Do not over tighten.

Note: Do not replace front panel at this time. Replace front panel after making gas connections and checking for leaks (see page 11).

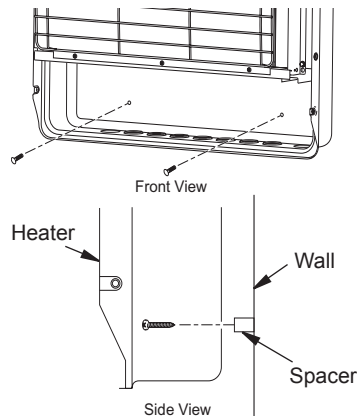

Figure 12 - Installing Bottom Mounting Screws

INSTALLATION

Continued

MOUNTING HEATER TO FLOOR (OPTIONAL)

Mounting Base Feet to Heater

1. Lay heater cabinet on its back on a table with the heater bottom overhanging the table edge.
2. Align holes in base foot with mounting holes on bottom of cabinet (see Figure 13).
3. Secure base foot to heater using sheet metal screws.
4. Repeat for other side.

Mounting Base Feet to Floor (Where required by local code)

1. Remove front cover (see *Removing Front Panel of Heater*, page 9).
2. Position heater with base feet in desired location. Mark holes for drilling. Remove heater with base.
3. For carpeted floors, make a small cut with a sharp knife at marked locations prior to drilling. If mounting base to a wood floor, drill 1/8" (3.2 mm) diameter hole, 3/4" (1.9 cm) deep. (Do not use anchors in wood floors).
If mounting base to a concrete floor, drill with 1/4" (6.4 mm) diameter concrete drill bit, 1 3/8" (3.5 cm) into floor. Insert anchors completely into holes.
4. Reposition heater with base feet over holes. Secure base to floor with wood screws. See Figure 13.

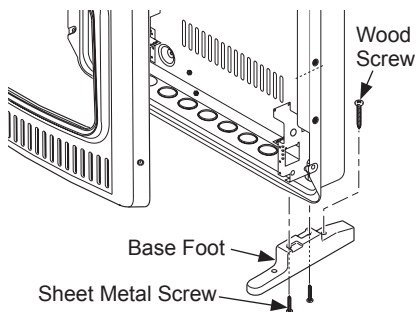

Figure 13 - Installing Base Feet

CONNECTING TO GAS SUPPLY

⚠ WARNING: This appliance requires a 3/8" NPT (National Pipe Thread) inlet connection to the pressure regulator.

⚠ WARNING: A qualified service person must connect heater to gas supply. Follow all local codes.

⚠ WARNING: For natural gas, never connect heater to private (non-utility) gas wells. This gas is commonly known as wellhead gas.

IMPORTANT: For natural gas, check gas line pressure before connecting heater to gas line. Gas line pressure must be no greater than 10.5 inches of water. If gas line pressure is higher, heater regulator damage could occur.

⚠ CAUTION: For propane/LP gas, never connect heater directly to the propane/LP supply. This heater requires an external regulator (not supplied). Install the external regulator between the heater and propane/LP supply.

For propane/LP gas, the installer must supply an external regulator. The external regulator will reduce incoming gas pressure. You must reduce incoming gas pressure to between 11 and 14 inches of water. If you do not reduce incoming gas pressure, heater regulator damage could occur. Install the external regulator with the vent pointing down as shown in Figure 14, page 12. Pointing the vent down protects it from freezing rain or sleet.

INSTALLATION

Continued

⚠ CAUTION: Use only new, black iron or steel pipe. Internally-tinned copper tubing may be used in certain areas. Check your local codes. Use pipe of large enough diameter to allow proper gas volume to heater. If pipe is too small, undue loss of volume will occur.

Typical Inlet Pipe Diameters

20,000 Btu/Hr Models - 3/8" or greater

30,000 Btu/Hr Models - 1/2" or greater

Installation must include equipment shutoff valve, union and plugged 1/8" NPT tap. Locate NPT tap within reach for test gauge hook up. NPT tap must be upstream from heater (see Figure 14).

IMPORTANT: Install an equipment shutoff valve in an accessible location. The equipment shutoff valve is for turning on or shutting off the gas to the appliance.

Apply pipe joint sealant lightly to male NPT threads. This will prevent excess sealant from going into pipe. Excess sealant in pipe could result in clogged heater valves.

⚠ WARNING: Use pipe joint sealant that is resistant to liquid petroleum (LP) gas.

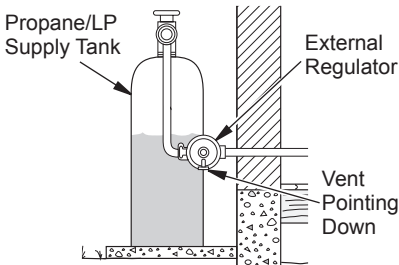

Figure 14 - External Regulator With Vent Pointing Down

Install sediment trap in supply line as shown in Figure 15. Locate sediment trap where it is within reach for cleaning. Locate sediment trap where trapped matter is not likely to freeze. A sediment trap traps moisture and contaminants. This keeps them from going into heater controls. If sediment trap is not installed or is installed wrong, heater may not run properly.

IMPORTANT: Hold the pressure regulator with wrench when connecting it to gas piping and/or fittings. Do not over tighten pipe connection to regulator. The regulator body could be damaged.

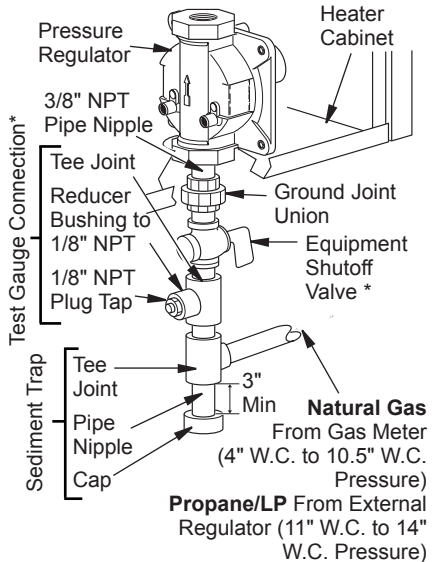

Figure 15 - Gas Connection

* A CSA design-certified equipment shutoff valve with 1/8" NPT tap is an acceptable alternative to test gauge connection. Purchase the optional CSA design-certified equipment shutoff valve from your dealer. See *Accessories*, page 26.

INSTALLATION

Continued

CHECKING GAS CONNECTIONS

⚠ WARNING: Test all gas piping and connections, internal and external to unit, for leaks after installing or servicing. Correct all leaks at once.

⚠ WARNING: Never use an open flame to check for a leak. Apply a noncorrosive leak detection fluid to all joints. Bubbles forming show a leak. Correct all leaks at once.

⚠ CAUTION: For propane/LP gas, make sure external regulator has been installed between propane/LP supply and heater. See guidelines under *Connecting to Gas Supply*, page 11.

PRESSURE TESTING GAS SUPPLY PIPING SYSTEM

Test Pressures In Excess Of 1/2 PSIG (3.5 kPa)

1. Disconnect appliance with its appliance main gas valve (control valve) and equipment shutoff valve from gas supply piping system. Pressures in excess of 1/2 psig will damage heater regulator.
2. Cap off open end of gas pipe where equipment shutoff valve was connected.
3. Pressurize supply piping system by either opening propane/LP supply tank valve for propane/LP gas or opening main gas valve located on or near gas meter for natural gas or using compressed air.
4. Check all joints of gas supply piping system. Apply a noncorrosive leak detection fluid to all joints. Bubbles forming show a leak.
5. Correct all leaks at once.
6. Reconnect heater and equipment shutoff valve to gas supply. Check reconnected fittings for leaks.

Test Pressures Equal To or Less Than 1/2 PSIG (3.5 kPa)

1. Close equipment shutoff valve (see Figure 16).
2. Pressurize supply piping system by either opening propane/LP supply tank valve for

propane/LP gas or opening main gas valve located on or near gas meter for natural gas or using compressed air.

3. Check all joints from gas meter for natural gas or propane/LP supply tank for propane/LP gas, to equipment shutoff valve (see Figure 17 or 18). Apply a noncorrosive leak detection fluid to all joints. Bubbles forming show a leak.
4. Correct all leaks at once.

PRESSURE TESTING HEATER GAS CONNECTIONS

1. Open equipment shutoff valve (see Figure 16).
2. For natural gas open main gas valve located on or near gas meter. For propane/LP gas open propane/LP supply tank valve.
3. Make sure control knob of heater is in the OFF position.
4. Check all joints from equipment shutoff valve to thermostat gas valve (see Figure 17 or 18). Apply a noncorrosive leak detection fluid to all joints. Bubbles forming show a leak.
5. Correct all leaks at once.
6. Light heater (see *Operating Heater*, page 14). Check all other internal joints for leaks.
7. Turn off heater (see *To Turn Off Gas to Appliance*, page 15).
8. Replace front panel.

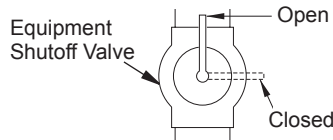

Figure 16 - Equipment Shutoff Valve

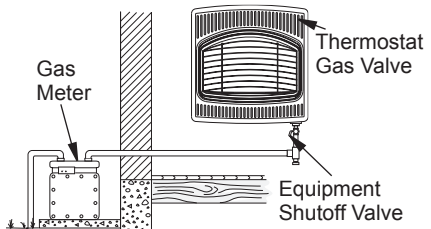

Figure 17 - Checking Gas Joints for Natural Gas

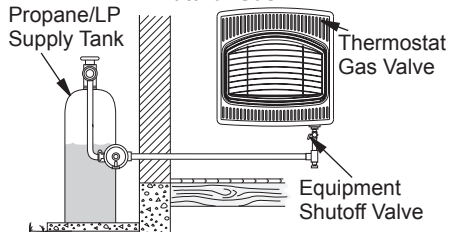

Figure 18 - Checking Gas Joints for Propane/LP Gas

OPERATING HEATER

FOR YOUR SAFETY READ BEFORE LIGHTING



WARNING: If you do not follow these instructions exactly, a fire or explosion may result causing property damage, personal injury or loss of life.

- A. This appliance has a pilot which must be lighted by hand. When lighting the pilot, follow these instructions exactly.
- B. BEFORE LIGHTING smell all around the appliance area for gas. Be sure to smell next to the floor because some gas is heavier than air and will settle on the floor.

WHAT TO DO IF YOU SMELL GAS

- Do not try to light any appliance.
 - Do not touch any electric switch; do not use any phone in your building.
 - Immediately call your gas supplier from a neighbor's phone. Follow the gas supplier's instructions.
 - If you cannot reach your gas supplier, call the fire department.
- C. Use only your hand to push in or turn the gas control knob. Never use tools. If the knob will not push in or turn by hand, don't try to repair it, call a qualified service technician. Force or attempted repair may result in a fire or explosion.
 - D. Do not use this appliance if any part has been under water. Immediately call a qualified service technician to inspect the appliance and to replace any part of the control system and any gas control which has been under water.

LIGHTING INSTRUCTIONS

1. STOP! Read the safety information above.
2. Make sure equipment shutoff valve is fully open.
3. Turn off any electric power to the appliance if service is to be performed.
4. Turn control knob clockwise  to the OFF position.
5. Wait five minutes to clear out any gas. Then smell for gas, including near the floor. If you smell gas, STOP! Follow "B" in the safety information above. If you don't smell gas, go to the next step.
6. Turn control knob counterclockwise  to the PILOT position. Press in control knob for five (5) seconds.
7. With control knob pressed in, push down and release ignitor button. This will light pilot. The pilot is attached to the front of burner. **Note:** You may be running this heater for the first time after hooking up to gas supply. If so, you may need to press in control knob for 30 seconds or more. This will allow air to bleed from the gas system. If needed, keep pressing ignitor button until pilot lights. If ignitor does not light pilot, refer to *Troubleshooting*, page 18 or contact a qualified service person or gas supplier for repairs. Until repairs are made, light pilot with match. To light pilot with match, see *Manual Lighting Procedure*, page 15.
8. Keep control knob pressed in for 30 seconds after lighting pilot. After 30 seconds, release control knob.
 - If control knob does not pop up when released, contact a qualified service person or gas supplier for repairs.**Note:** If pilot goes out, repeat steps 4 thru 7. Thermostat models have a safety interlock system. Wait one (1) minute before lighting pilot again.
9. Turn control knob counterclockwise  to desired heating level. The main burner should light.

CAUTION: Do not try to adjust heating levels by using the equipment shutoff valve.

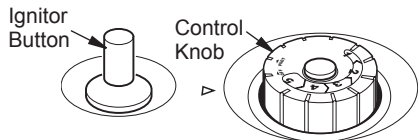

Figure 19 - Control Knob In The OFF Position

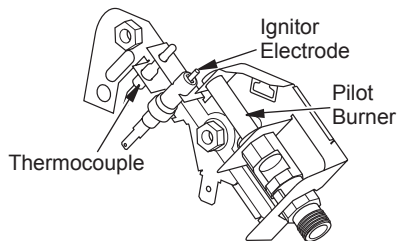



Figure 20 - Pilot

OPERATING HEATER

Continued

TO TURN OFF GAS TO APPLIANCE

Shutting Off Heater

1. Turn control knob clockwise  to the OFF position.
2. Turn off all electric power to the appliance if service is to be performed.

Shutting Off Burner Only (pilot stays lit)

Turn control knob clockwise  to the PILOT position.

THERMOSTAT CONTROL OPERATION

The thermostatic control used on these models differs from standard thermostats. Standard thermostats simply turn on and off the burner. The thermostat used on this heater senses the room temperature. At times the room may exceed the set temperature. If so, the burner will shut off. The burner will cycle back on when room temperature drops below the set temperature. The control knob can be set to any heat level between 1 and 5. This adjusts the amount of gas flow to the burner that increases or decreases the burner flame height.

Note: The thermostat sensing bulb measures the temperature of air near the heater cabinet. This may not always agree with room temperature (depending on housing construction, installation location, room size, open air temperatures, etc.) Frequent use of your heater will let you determine your own comfort levels.

MANUAL LIGHTING PROCEDURE

1. Remove front panel (see Figure 7, page 9).
2. Follow steps 1 through 7 under *Lighting Instructions*, page 14.
3. With control knob pressed in, strike match. Hold match to pilot until pilot lights.
4. Keep control knob pressed in for 30 seconds after lighting pilot. After 30 seconds, release control knob. Now follow step 9, under *Lighting Instructions*, page 14.
5. Replace front panel.

INSPECTING HEATER

Check pilot flame pattern and burner flame pattern often.

PILOT FLAME PATTERN

Figure 21 shows a correct pilot flame pattern. Figure 22 shows an incorrect pilot flame pattern. The incorrect pilot flame is not touching the thermocouple. This will cause the thermocouple to cool. When the thermocouple cools, the heater will shut down.

If pilot flame pattern is incorrect, as shown in Figure 22

- turn heater off (see *To Turn Off Gas to Appliance*)
- see *Troubleshooting*, page 18

Note: The pilot flame on natural gas units will have a slight curve, but flame should be blue and have no yellow or orange color.

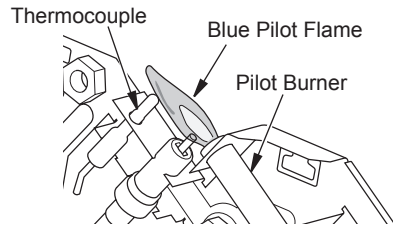

Figure 21 - Correct Pilot Flame Pattern

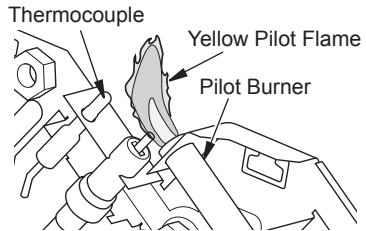

Figure 22 - Incorrect Pilot Flame Pattern

INSPECTING HEATER

Continued

BURNER FLAME PATTERN

WARNING: If yellow tipping occurs, your heater could produce increased levels of carbon monoxide.

NOTICE: Do not mistake orange flames with yellow tipping. Dirt or other fine particles enter the heater and burn causing brief patches of orange flame.

Figure 23 shows a correct burner flame pattern. Figure 24 shows an incorrect burner flame pattern. The incorrect burner flame pattern shows yellow tipping of the flame. It also shows the flame higher than 1/2 the glass panel height.

If burner flame pattern is incorrect, as shown in Figure 24

- turn heater off (see *To Turn Off Gas to Appliance*, page 15)
- see *Troubleshooting*, page 18

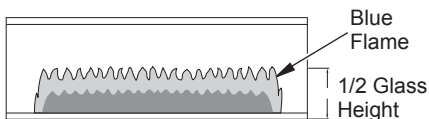

Figure 23 - Correct Burner Flame Pattern

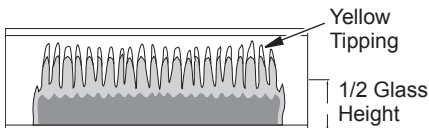

Figure 24 - Incorrect Burner Flame Pattern

CLEANING AND MAINTENANCE

WARNING: Turn off heater and let cool before cleaning.

CAUTION: You must keep control areas, burner and circulating air passageways of heater clean. Inspect these areas of heater before each use. Have heater inspected yearly by a qualified service person. Heater may need more frequent cleaning due to excessive lint from carpeting, bedding material, pet hair, etc.

WARNING: Failure to keep the primary air opening(s) of the burner(s) clean may result in sooting and property damage.

ODS/PILOT AND BURNER

Use a vacuum cleaner, pressurized air or small, soft bristled brush to clean.

BURNER PILOT AIR INLET

The primary air inlet holes allow the proper amount of air to mix with the gas. This provides a clean burning flame. Keep these holes clear of dust, dirt and lint. Clean these air inlet holes prior to each heating season. Blocked air holes will create soot. We recommend that you clean the unit every three months during operation and have heater inspected yearly by a qualified service person.

We also recommend that you keep the burner tube and pilot assembly clean and free of dust and dirt. To clean these parts we recommend using compressed air no greater than 30 PSI. Your local computer store, hardware store or home center may carry compressed air in a can. You can use a vacuum cleaner in the blow position. If using compressed air in a can, please follow the directions on the can. If you don't follow directions on the can, you could damage the pilot assembly.

CLEANING AND MAINTENANCE

Continued

1. Shut off the unit, including the pilot. Allow the unit to cool for at least thirty minutes.
2. Inspect burner, pilot for dust and dirt.
3. Blow air across the ports/slots and holes in the burner.
4. Never insert objects into the pilot tube.

Clean the pilot assembly also. A yellow tip on the pilot flame indicates dust and dirt in the pilot assembly. There is a small pilot air inlet about two inches from where the pilot flame comes out of the pilot assembly (see Figure 25). With the unit off, lightly blow air through the air inlet. You may blow through a drinking straw if compressed air is not available.

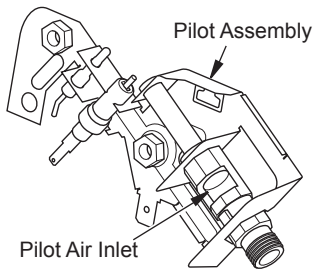

Figure 25 - Pilot Air Inlet

CABINET

Air Passageways

Use a vacuum cleaner or pressurized air to clean.

Exterior

Use a soft cloth dampened with a mild soap and water mixture. Wipe the cabinet to remove dust.

SERVICE HINTS

When Gas Pressure Is Too Low

- pilot will not stay lit
- burner will have delayed ignition
- heater will not produce specified heat
- propane/LP gas supply may be low

You may feel your gas pressure is too low. If so, contact your local natural or propane/LP gas supplier.

TECHNICAL SERVICE

You may have further questions about installation, operation or troubleshooting. If so, contact DESA Heating Products' Technical Service Department at 1-866-672-6040. When calling please have your model and serial numbers of your heater ready.

You can also visit DESA Heating Products' technical service web site at www.desatech.com.

TROUBLESHOOTING

⚠ WARNING: Turn off and unplug heater and let cool before servicing. Only a qualified service person should service and repair heater.

⚠ CAUTION: Never use a wire, needle or similar object to clean ODS/pilot. This can damage ODS/pilot unit.

Note: All troubleshooting items are listed in order of operation.

OBSERVED PROBLEM	POSSIBLE CAUSE	REMEDY
When ignitor button is pressed in, there is no spark at ODS/pilot	<ol style="list-style-type: none"> 1. Ignitor electrode positioned wrong 2. Ignitor electrode broken 3. Ignitor electrode not connected to ignitor cable 4. Ignitor cable pinched or wet 5. Broken ignitor cable 6. Bad ignitor 7. Piezo ignitor nut is loose (piezo ignition models only) 8. Battery not installed, battery power low or battery not installed correctly (electronic ignition models only) 	<ol style="list-style-type: none"> 1. Replace pilot assembly 2. Replace pilot assembly 3. Reconnect ignitor cable 4. Free ignitor cable if pinched by any metal or tubing. Keep ignitor cable dry 5. Replace ignitor cable 6. Replace ignitor 7. Tighten nut holding piezo ignitor. Nut is located inside heater cabinet at top 8. Install new alkaline battery in electronic ignitor. Verify battery is installed correctly
When ignitor button is pressed in, there is a spark at ODS/Pilot but no ignition	<ol style="list-style-type: none"> 1. Gas supply turned off or equipment shutoff valve closed 2. Control knob is not in pilot position 3. Control knob not fully pressed in while pressing ignitor button 4. Air in gas lines when installed 5. Depleted gas supply (propane/LP gas) 6. ODS/pilot is clogged 7. Gas regulator setting is not correct 	<ol style="list-style-type: none"> 1. Turn on gas supply or open equipment shutoff valve 2. Turn control knob to pilot position 3. Turn to PILOT position. Fully press in control knob while pressing ignitor button 4. Continue holding down control knob. Repeat igniting operation until air is removed 5. Contact local propane/LP gas company 6. Clean ODS/pilot (see <i>Cleaning and Maintenance</i>, page 16) or replace ODS/pilot assembly 7. Replace gas regulator

TROUBLESHOOTING

Continued

OBSERVED PROBLEM	POSSIBLE CAUSE	REMEDY
<p>ODS/pilot lights but flame goes out when control knob is released</p>	<ol style="list-style-type: none"> 1. Control knob not fully pressed in 2. Control knob not pressed in long enough 3. Equipment shutoff valve not fully open 4. Thermocouple connection loose at control valve 5. Pilot flame not touching thermocouple, which allows thermocouple to cool, causing pilot flame to go out. This problem could be caused by one or both of the following: <ol style="list-style-type: none"> A) Low gas pressure B) Dirty or partially clogged ODS/pilot 6. Thermocouple damaged 7. Control valve damaged 8. Safety interlock system has been triggered 	<ol style="list-style-type: none"> 1. Press in control knob fully 2. After ODS/pilot lights, keep control knob pressed in 30 seconds 3. Fully open equipment shutoff valve 4. Hand tighten until snug, then tighten 1/4 turn more 5. A) Contact local natural or propane/LP gas company B) Clean ODS/pilot (see <i>Cleaning and Maintenance</i>, page 16) or replace ODS/pilot assembly 6. Replace pilot assembly 7. Replace control valve 8. Wait one minute for safety interlock system to reset. Repeat ignition operation
<p>Burner(s) does not light after ODS/pilot is lit</p>	<ol style="list-style-type: none"> 1. Burner orifice(s) is clogged 2. Inlet gas pressure is too low 	<ol style="list-style-type: none"> 1. Clean burner orifice(s) (see <i>Cleaning and Maintenance</i>, page 16) or replace burner orifice(s) 2. Contact local natural or propane/LP gas company
<p>Delayed ignition of burner(s)</p>	<ol style="list-style-type: none"> 1. Manifold pressure is too low 2. Burner orifice(s) is clogged 	<ol style="list-style-type: none"> 1. Contact local natural or propane/LP gas company 2. Clean burner orifice(s) (see <i>Cleaning and Maintenance</i>, page 16) or replace burner orifice(s)
<p>Burner backfiring during combustion</p>	<ol style="list-style-type: none"> 1. Burner orifice(s) is clogged or damaged 2. Burner damaged 3. Gas regulator defective 	<ol style="list-style-type: none"> 1. Clean burner orifice(s) (see <i>Cleaning and Maintenance</i>, page 16) or replace burner orifice(s) 2. Replace burner 3. Replace gas regulator

TROUBLESHOOTING

Continued

OBSERVED PROBLEM	POSSIBLE CAUSE	REMEDY
Yellow flame during burner combustion	<ol style="list-style-type: none">1. Not enough air2. Gas regulator defective3. Clogged or dirty burner	<ol style="list-style-type: none">1. Check burner for dirt and debris. If found, clean burner (see <i>Cleaning and Maintenance</i>, page 16)2. Replace gas regulator3. Clean burner (see <i>Cleaning and Maintenance</i>, page 16)
Slight smoke or odor during initial operation	<ol style="list-style-type: none">1. Residues from manufacturing processes	<ol style="list-style-type: none">1. Problem will stop after a few hours of operation
Heater produces a clicking/ticking noise just after burner is lit or shut off	<ol style="list-style-type: none">1. Metal expanding while heating or contracting while cooling	<ol style="list-style-type: none">1. This is common with most heaters. If noise is excessive, contact qualified service person
Heater produces a whistling noise when burner is lit	<ol style="list-style-type: none">1. Turning control knob to the highest position when burner is cold2. Air in gas line3. Air passageways on heater blocked4. Dirty or partially clogged burner orifice	<ol style="list-style-type: none">1. Turn control knob to the lowest position and let warm up for a minute2. Operate burner until air is removed from line. Have gas line checked by local natural or propane/LP gas company3. Observe minimum installation clearances (see Figure 4, page 8)4. Clean burner (see <i>Cleaning and Maintenance</i>, page 16) or replace burner orifice
White powder residue forming within burner box or on adjacent walls or furniture	<ol style="list-style-type: none">1. When heated, vapors from furniture polish, wax, carpet cleaner, etc., may turn into white powder residue	<ol style="list-style-type: none">1. Turn heater off when using furniture polish, wax, carpet cleaners or similar products
Heater shuts off in use (ODS operates)	<ol style="list-style-type: none">1. Not enough fresh air is available2. Low line pressure3. ODS/pilot is partially clogged	<ol style="list-style-type: none">1. Open window and/or door for ventilation2. Contact local natural or propane/LP gas company3. Clean ODS/pilot (see <i>Cleaning and Maintenance</i>, page 16)

TROUBLESHOOTING

Continued



WARNING: If you smell gas

- Shut off gas supply.
- Do not try to light any appliance.
- Do not touch any electrical switch; do not use any phone in your building.
- Immediately call your gas supplier from a neighbor's phone. Follow the gas supplier's instructions.
- If you cannot reach your gas supplier, call the fire department.

IMPORTANT: Operating heater where impurities in air exist may create odors. Cleaning supplies, paint, paint remover, cigarette smoke, cements and glues, new carpet or textiles, etc., create fumes. These fumes may mix with combustion air and create odors.

OBSERVED PROBLEM	POSSIBLE CAUSE	REMEDY
Heater produces unwanted odors	<ol style="list-style-type: none">1. Heater burning vapors from paint, hair spray, glues, etc. See <i>IMPORTANT</i> statement above2. Low fuel supply (propane/LP gas)3. Gas leak. See Warning statement at top of page	<ol style="list-style-type: none">1. Ventilate room. Stop using odor causing products while heater is running2. Refill supply tank3. Locate and correct all leaks (see <i>Checking Gas Connections</i>, page 13)
Gas odor even when control knob is in OFF position	<ol style="list-style-type: none">1. Gas leak. See Warning statement at top of page2. Control valve defective	<ol style="list-style-type: none">1. Locate and correct all leaks (see <i>Checking Gas Connections</i>, page 13)2. Replace control valve
Gas odor during combustion	<ol style="list-style-type: none">1. Foreign matter between control valve and burner2. Gas leak. See Warning statement at top of page	<ol style="list-style-type: none">1. Take apart gas tubing and remove foreign matter2. Locate and correct all leaks (see <i>Checking Gas Connections</i>, page 13)
Moisture/condensation noticed on windows	<ol style="list-style-type: none">1. Not enough combustion/ventilation air	<ol style="list-style-type: none">1. Refer to <i>Air for Combustion and Ventilation</i> requirements (page 5)

SPECIFICATIONS

CBN20T

- Natural Gas
- 10,000/20,000 Btu/Hr (Variable)
- Piezo Ignition
- Pressure Regulator Setting - 3" W.C.
- Inlet Gas Pressure* (in. of water)
Maximum - 10.5" - Minimum - 4"
- Heater Dimensions H x W x D
26.25" x 18.25" x 7" (66.7 x 46.4 x 17.8 cm)
- Carton Dimensions H x W x D
28.5" x 21" x 10.25" (72.4 x 53.3 x 26 cm)
- Average Heater Weight - 23.4 lb (10.6 kg)
- Average Shipping Weight - 27 lb (12.2 kg)

CBP20T

- Propane/LP Gas
- 10,000/20,000 Btu/Hr (Variable)
- Piezo Ignition
- Pressure Regulator Setting - 8" W.C.
- Inlet Gas Pressure* (in. of water)
Maximum - 14" - Minimum - 11"
- Heater Dimensions H x W x D
26.25" x 18.25" x 7" (66.7 x 46.4 x 17.8 cm)
- Carton Dimensions H x W x D
28.5" x 21" x 10.25" (72.4 x 53.3 x 26 cm)
- Average Heater Weight - 23.4 lb (10.6 kg)
- Average Shipping Weight - 27 lb (12.2 kg)

CBT20NT

- Natural Gas
- 10,000/20,000 Btu/Hr (Variable)
- Electronic Ignition
- Pressure Regulator Setting - 3" W.C.
- Inlet Gas Pressure* (in. of water)
Maximum - 10.5" - Minimum - 4"
- Heater Dimensions H x W x D
26.25" x 18.25" x 7" (66.7 x 46.4 x 17.8 cm)
- Carton Dimensions H x W x D
28.75" x 21" x 10.38" (73 x 53.3 x 26.4 cm)
- Average Heater Weight - 21.9 lb (9.9 kg)
- Average Shipping Weight - 25.4 lb (11.5 kg)

CBT20PT

- Propane/LP Gas
- 10,000/20,000 Btu/Hr (Variable)
- Electronic Ignition
- Pressure Regulator Setting - 8" W.C.
- Inlet Gas Pressure* (in. of water)
Maximum - 14" - Minimum - 11"
- Heater Dimensions H x W x D
26.25" x 18.25" x 7" (66.7 x 46.4 x 17.8 cm)
- Carton Dimensions H x W x D
28.75" x 21" x 10.38" (73 x 53.3 x 26.4 cm)
- Average Heater Weight - 21.9 lb (9.9 kg)
- Average Shipping Weight - 25.4 lb (11.5 kg)

CBN30T

- Natural Gas
- 15,000/30,000 Btu/Hr (Variable)
- Piezo Ignition
- Pressure Regulator Setting - 3" W.C.
- Inlet Gas Pressure* (in. of water)
Maximum - 10.5" - Minimum - 4"
- Heater Dimensions H x W x D
26.25" x 25.75" x 7" (66.7 x 65.4 x 17.8 cm)
- Carton Dimensions H x W x D
28.75" x 28.5" x 10.25" (73 x 72.3 x 26 cm)
- Average Heater Weight - 27.3 lb (12.4 kg)
- Average Shipping Weight - 31.5 lb (14.3 kg)

CBP30T

- Propane/LP Gas
- 15,000/30,000 Btu/Hr (Variable)
- Piezo Ignition
- Pressure Regulator Setting - 8" W.C.
- Inlet Gas Pressure* (in. of water)
Maximum - 14" - Minimum - 11"
- Heater Dimensions H x W x D
26.25" x 25.75" x 7" (66.7 x 65.4 x 17.8 cm)
- Carton Dimensions H x W x D
28.75" x 28.5" x 10.25" (73 x 72.3 x 26 cm)
- Average Heater Weight - 27.3 lb (12.4 kg)
- Average Shipping Weight - 31.5 lb (14.3 kg)

Note: Dimensions listed are outer most points on the heater (includes control knobs and grill).

* For purposes of input adjustment.

SPECIFICATIONS

Continued

CBT30NT

- Natural Gas
- 15,000/30,000 Btu/Hr (Variable)
- Electronic Ignition
- Pressure Regulator Setting - 3" W.C.
- Inlet Gas Pressure* (in. of water)
Maximum - 10.5" - Minimum - 4"
- Heater Dimensions H x W x D
26.25" x 25.75" x 7" (66.7 x 65.4 x 17.8 cm)
- Carton Dimensions H x W x D
28.75" x 28.25" x 10.38" (73 x 71.8 x 26 cm)
- Average Heater Weight - 27.3 lb (12.4 kg)
- Average Shipping Weight - 31.5 lb (14.3 kg)

CBT30PT

- Propane/LP Gas
- 15,000/30,000 Btu/Hr (Variable)
- Electronic Ignition
- Pressure Regulator Setting - 8" W.C.
- Inlet Gas Pressure* (in. of water)
Maximum - 14" - Minimum - 11"
- Heater Dimensions H x W x D
26.25" x 25.75" x 7" (66.7 x 65.4 x 17.8 cm)
- Carton Dimensions H x W x D
28.75" x 28.25" x 10.38" (73 x 71.8 x 26 cm)
- Average Heater Weight - 27.3 lb (12.4 kg)
- Average Shipping Weight - 31.5 lb (14.3 kg)

Note: Dimensions listed are outer most points on the heater (includes control knobs and grill).

* For purposes of input adjustment.

REPLACEMENT PARTS

Note: Use only original replacement parts. This will protect your warranty coverage for parts replaced under warranty.

PARTS UNDER WARRANTY

Contact authorized dealers of this product. If they can't supply original replacement part(s), call DESA Heating Products' Technical Service Department at 1-866-672-6040.

When calling DESA Heating Products, have ready

- your name
- your address
- model and serial numbers of your heater
- how heater was malfunctioning
- type of gas used (propane/LP or natural gas)
- purchase date

Usually, we will ask you to return the part to the factory.

PARTS NOT UNDER WARRANTY

Contact authorized dealers of this product. If they can't supply original replacement part(s), either contact your nearest Parts Central (see page 27) or call DESA Heating Products at 1-866-672-6040 for referral information.

When calling DESA Heating Products, have ready

- model number of your heater
- the replacement part number

SERVICE PUBLICATIONS

You can purchase a service manual from the address listed on the back page of this manual. Send a check for \$5.00 payable to DESA Heating Products.

ILLUSTRATED PARTS BREAKDOWN

MODELS

CBN20T, CBP20T, CBN30T, CBP30T, CBT20NT, CBT20PT, CBT30NT AND CBT30PT

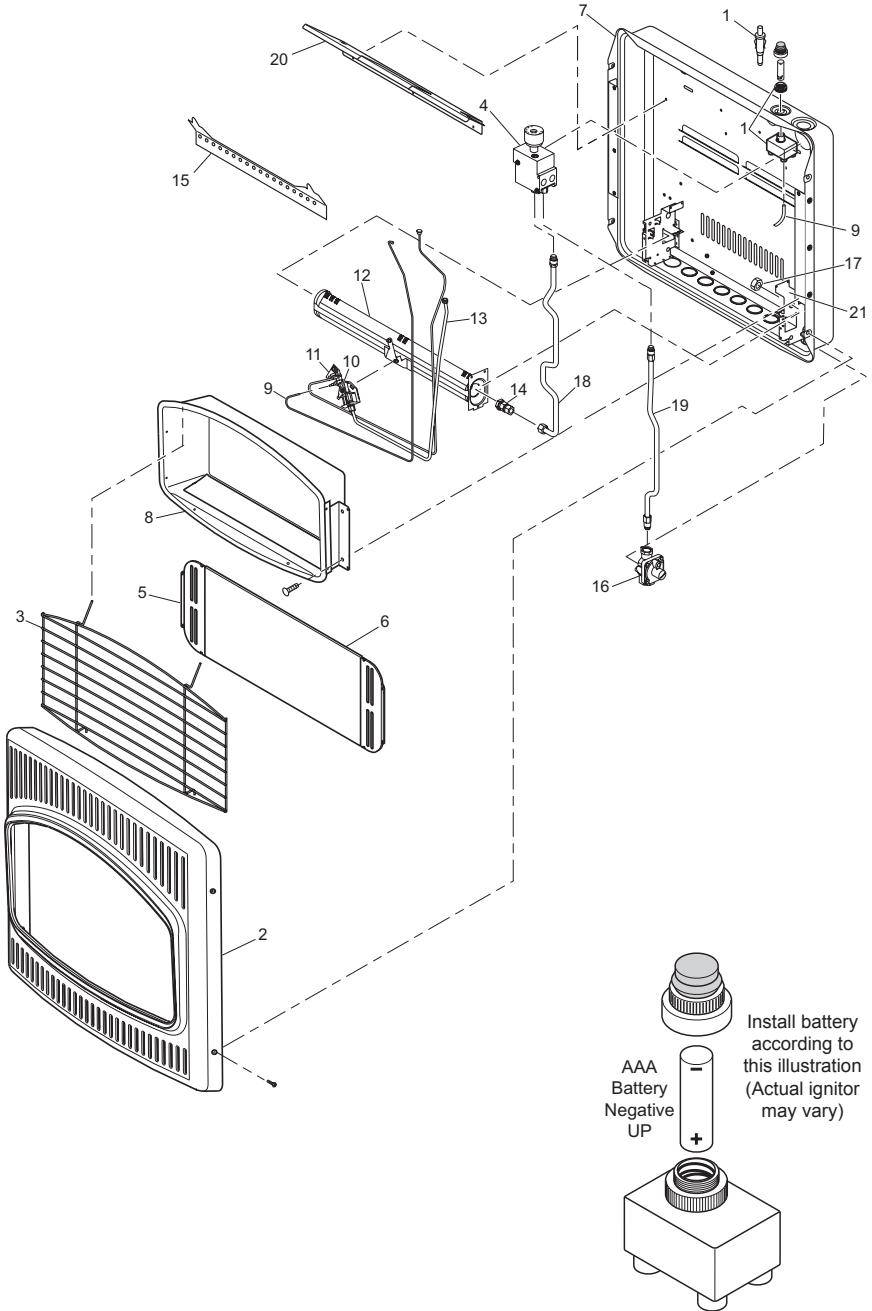

PARTS LIST

This list contains replaceable parts used in your heater. When ordering parts, follow the instructions listed under *Replacement Parts* on page 23 of this manual.

KEY NO.	PART NO.	DESCRIPTION	CBN20T	CBP20T	CBN30T	CBP30T	CBT20NT	CBT20PT	CBT30NT	CBT30PT	QTY
1	111435-01	Electronic Ignitor									1
	097159-04	Piezo Ignitor	•	•	•	•	•	•	•	•	1
2	107954-03CV	Front Panel					•	•			1
	107954-01	Front Panel	•	•							1
	107955-01	Front Panel			•	•					1
	107955-03CV	Front Panel							•	•	1
3	107879-01	Grill Guard			•	•			•	•	1
	107879-02	Grill Guard	•	•			•	•			1
4	098522-28	T-stat Gas Valve	•				•				1
	098522-11	T-stat Gas Valve		•				•			1
	098522-12	T-stat Gas Valve			•				•		1
	098522-13	T-stat Gas Valve				•			•		1
5	107677-01	Glass Retainer	•	•	•	•	•	•	•	•	2
6	098260-12	Glass	•	•			•	•			1
	098260-13	Glass			•				•	•	1
7	**	Cabinet	•	•	•	•	•	•	•	•	1
8	107894-08	Deflector Assembly	•	•			•				1
	107894-09	Deflector Assembly			•	•			•	•	1
9	098271-11	Ignitor Cable					•	•			1
	098271-09	Ignitor Cable	•	•	•	•					1
10	098249-01	ODS Pilot Nut	•	•	•	•	•	•	•	•	2
11	110803-01	ODS/Pilot Assembly	•	•				•			1
	110803-02	ODS/Pilot Assembly	•	•	•			•		•	1
12	103446-02	Burner	•	•			•	•			1
	103447-06	Burner			•	•			•	•	1
13	099387-03	3/16" Pilot Tubing	•	•	•	•	•	•	•	•	1
14	103845-05	Injector		•				•			1
	103845-06	Injector	•			•					1
	103845-07	Injector			•				•		1
	103845-08	Injector			•				•		1
15	099066-02	Mounting Bracket	•	•	•	•	•	•	•	•	1
16	099415-17	Gas Regulator	•	•		•		•			1
	099415-18	Gas Regulator		•	•			•	•		1
17	NJF 8C	Hex Nut	•	•	•	•	•	•	•	•	1
18	103255-02	3/8" Outlet Tubing	•	•	•	•	•	•	•	•	1
19	103256-02	3/8" Inlet Tubing	•	•	•	•	•	•	•	•	1
20	109303-03	Baffle			•	•			•	•	1
	109303-04	Baffle	•	•				•			1
21	103408-02	Burner Bracket	•	•	•	•	•	•	•	•	2
PARTS AVAILABLE — NOT SHOWN											
	107888-01	Control Position Label	•	•	•	•					1
	107888-03	Control Position Label					•	•			1
	116354-02	Control Position Label							•	•	1
	110186-01	Thermocouple Kit	•	•	•	•	•	•	•	•	1
	100642-03	Hardware Assembly	•	•	•	•	•	•	•	•	1
	105345-01	Cable Tie	•	•	•	•	•	•	•	•	1
	116360-01	Lighting/Warning Tag (English)	•	•	•	•	•	•	•	•	1
	116360-02	Lighting/Warning Tag (Spanish)	•	•	•	•	•	•	•	•	1
	102394-02	Valve Mounting Bracket	•	•	•	•	•	•	•	•	1
	109121-01	Pilot Shield	•	•	•	•	•	•	•	•	1
	109121-02	Pilot Shield	•								1

** Not a field replaceable part.

ACCESSORIES

Purchase these heater accessories from your local dealer. If they can not supply these accessories, either contact your nearest Parts Central (see page 27) or call DESA Heating Products at 1-866-672-6040 for referral information. You can also write to the address listed on the back page of this manual.

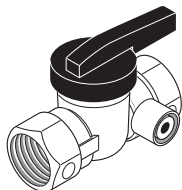

EQUIPMENT SHUTOFF VALVE GA5010

For all models. Equipment shutoff valve with 1/8" NPT tap.

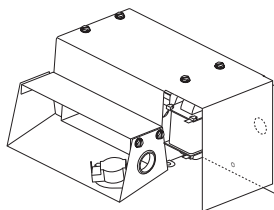

FAN KITS - GA3250T

For all models. Provides better heat distribution. Makes heater more efficient. Complete installation and operating instructions included.

Thermostatically-controlled, blower turns itself on and off as required.

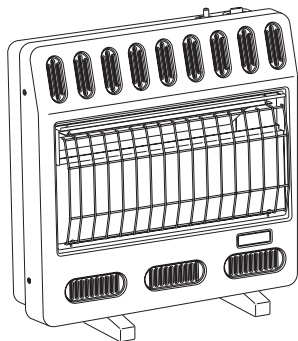

FLOOR MOUNTING KIT - GA4550

For all models. For locating heater on the floor, away from a wall. Complete installation and operating instructions included.

ELECTRONIC IGNITOR KIT - GA435 Not Shown

For all piezo ignitor models. Provides easier lighting of the pilot.

PARTS CENTRAL

These Parts Centrals are privately owned businesses. They have agreed to support our customer's needs by providing original replacement parts and accessories.

Tool & Equipment Co.

5 Manila Ave
Hamden, CT 06514-0322
1-800-397-7553
203-248-7553

Portable Heater Parts

342 N. County Rd. 400 East
Valparaiso, IN 46383-9704
219-462-7441
1-888-619-7060
www.portableheaterparts.com
sales@portableheaterparts.com
techservice@portableheaterparts.com

FBD

1349 Adams Street
Bowling Green, KY 42103-3414
270-846-1199
1-800-654-8534
Fax: 1-800-846-0090
franktalk@aol.com

Master Parts Dist.

1251 Mound Ave. NW
Grand Rapids, MI 49504-2672
616-791-0505
1-800-446-1446
www.nbmc.com

Washer Equipment Co.

1715 Main Street
Kansas City, MO 64108-2195
KS, MO, AR
816-842-3911
www.washerparts.com

East Coast Energy

707 Broadway
W. Long Branch, NJ 07764-1501
732-870-8809
1-800-755-8809
www.njplaza.com/ecep

21st Century

2950 Fretz Valley
Perkasie, PA 18944-4034
215-795-0400
800-325-4828

Laporte's Parts & Service

2444 N. 5th Street
Hartsville, SC 29550-7704
843-332-0191
Parts Department

Cans Unlimited

P.O. Box 645
Taylor, SC 29687-0013
803-879-3009
1-800-845-5301
cuissales@aol.com

WARRANTY INFORMATION

KEEP THIS WARRANTY

Model _____
Serial No. _____
Date Purchased _____

Always specify model and serial numbers when communicating with the factory.

We reserve the right to amend these specifications at any time without notice. The only warranty applicable is our standard written warranty. We make no other warranty, expressed or implied.

LIMITED WARRANTIES FOR NEW AND FACTORY RECONDITIONED PRODUCTS

New Products: DESA Heating Products warrants this heater and any parts thereof, to be free of defects in materials and workmanship for two (2) years from the date of first purchase, when operated and maintained in accordance with the manufacturer's instructions. These warranties are extended only to the original retail purchaser, when proof of purchase is provided.

Factory Reconditioned Heaters: DESA Heating Products warrants this factory reconditioned heater and any parts thereof, to be free of defects in materials and workmanship for thirty (30) days from the date of first purchase, when operated and maintained in accordance with the manufacturer's instructions. These warranties are extended only to the original retail purchaser, when proof of purchase is provided.

This warranty is extended only to the original retail purchaser. This warranty covers the cost of part(s) required to restore this heater to proper operating condition and an allowance for labor when provided by a DESA Heating Products Authorized Service Center. Warranty part(s) MUST be obtained through authorized dealers of this product and/or DESA Heating Products who will provide original factory replacement parts. Failure to use original factory replacement parts voids this warranty. The heater MUST be installed by a qualified installer in accordance with all local codes and instructions furnished with the unit.

This warranty does not apply to parts that are not in original condition because of normal wear and tear or parts that fail or become damaged as a result of misuse, accidents, lack of proper maintenance or defects caused by improper installation. Travel, diagnostic cost, labor, transportation and any and all such other costs related to repairing a defective heater will be the responsibility of the owner.

TO THE FULL EXTENT ALLOWED BY THE LAW OF THE JURISDICTION THAT GOVERNS THE SALE OF THE PRODUCT; THIS EXPRESS WARRANTY EXCLUDES ANY AND ALL OTHER EXPRESSED WARRANTIES AND LIMITS THE DURATION OF ANY AND ALL IMPLIED WARRANTIES, INCLUDING WARRANTIES OF MERCHANTABILITY AND FITNESS FOR A PARTICULAR PURPOSE TO TWO (2) YEARS ON ALL COMPONENTS FROM THE DATE OF FIRST PURCHASE; AND DESA HEATING PRODUCTS' LIABILITY IS HEREBY LIMITED TO THE PURCHASE PRICE OF THE PRODUCT AND DESA HEATING PRODUCTS SHALL NOT BE LIABLE FOR ANY OTHER DAMAGES WHATSOEVER INCLUDING INDIRECT, INCIDENTAL OR CONSEQUENTIAL DAMAGES.

Some states do not allow a limitation on how long an implied warranty lasts or an exclusion or limitation of incidental or consequential damages, so the above limitation on implied warranties or exclusion or limitation on damages may not apply to you.

This warranty gives you specific legal rights and you may also have other rights that vary from state to state.

For information about this warranty write:

DESA[™]
INDOOR/OUTDOOR PRODUCTS
P.O. Box 90004
Bowling Green, KY 42102-9004
www.desatech.com



107882 01
NOT A UPC

107882-01
Rev. M
05/05

Patent Pending

Free Manuals Download Website

<http://myh66.com>

<http://usermanuals.us>

<http://www.somanuals.com>

<http://www.4manuals.cc>

<http://www.manual-lib.com>

<http://www.404manual.com>

<http://www.luxmanual.com>

<http://aubethermostatmanual.com>

Golf course search by state

<http://golfingnear.com>

Email search by domain

<http://emailbydomain.com>

Auto manuals search

<http://auto.somanuals.com>

TV manuals search

<http://tv.somanuals.com>