

FLAME-MAX[®]

Multi-Sided
Log Design

VYM27NR/PR
VVFM27NR/PR

Remote Control
Ready Model

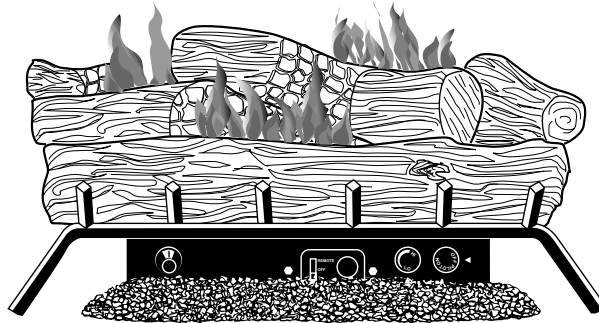

Patent Pending

Also Design-Certified As A Vented Decorative Appliance

WARNING: If the information in this manual is not followed exactly, a fire or explosion may result causing property damage, personal injury, or loss of life.

- Do not store or use gasoline or other flammable vapors and liquids in the vicinity of this or any other appliance.
- **WHAT TO DO IF YOU SMELL GAS**
 - Do not try to light any appliance.
 - Do not touch any electrical switch; do not use any phone in your building.
 - Immediately call your gas supplier from a neighbor's phone. Follow the gas supplier's instructions.
 - If you cannot reach your gas supplier, call the fire department.
- Installation and service must be performed by a qualified installer, service agency, or the gas supplier.

WARNING: Improper installation, adjustment, alteration, service, or maintenance can cause injury or property damage. Refer to this manual for correct installation and operational procedures. For assistance or additional information consult a qualified installer, service agency, or the gas supplier.

WARNING: This appliance is for installation only in a solid-fuel burning masonry or UL127 factory-built fireplace, or in an approved ventless firebox. It is design certified for these installations in accordance with ANSI Z21.11.2. Exception: Do not install this appliance in a factory-built fireplace that includes instructions stating it has not been tested or should not be used with unvented gas logs.

WARNING: This is an unvented gas-fired heater. It uses air (oxygen) from the room in which it is installed. Provisions for adequate combustion and ventilation air must be provided. Refer to *Air for Combustion and Ventilation* section on page 4 of this manual.

This appliance may be installed in an aftermarket,* manufactured (mobile) home, where not prohibited by local codes.

This appliance is only for use with the type of gas indicated on the rating plate. This appliance is not convertible for use with other gases.

* Aftermarket: Completion of sale, not for purpose of resale, from the manufacturer

TABLE OF CONTENTS

SAFETY INFORMATION	2	TROUBLESHOOTING	18
PRODUCT IDENTIFICATION	3	WIRING DIAGRAM	21
LOCAL CODES	4	SPECIFICATIONS	21
UNPACKING	4	SERVICE HINTS	21
PRODUCT FEATURES	4	TECHNICAL SERVICE	21
REMOTE CONTROL ACCESSORIES	4	REPLACEMENT PARTS	21
AIR FOR COMBUSTION AND VENTILATION	4	ILLUSTRATED PARTS BREAKDOWN AND PARTS LIST	22
INSTALLATION	7	ACCESSORIES	24
OPERATING HEATER	14	OWNER'S REGISTRATION FORM	25
INSPECTING BURNERS	16	WARRANTY INFORMATION	Back Cover
CLEANING AND MAINTENANCE	17		

SAFETY INFORMATION

WARNINGS

IMPORTANT: Read this owner's manual carefully and completely before trying to assemble, operate, or service this fireplace. Improper use of this fireplace can cause serious injury or death from burns, fire, explosions, electrical shock, and carbon monoxide poisoning.

 DANGER: Carbon monoxide poisoning may lead to death!

Carbon Monoxide Poisoning: Early signs of carbon monoxide poisoning resemble the flu, with headaches, dizziness, or nausea. If you have these signs, the fireplace may not have been installed properly. **Get fresh air at once!** Have fireplace inspected and serviced by a qualified service person. Some people are more affected by carbon monoxide than others. These include pregnant women, people with heart or lung disease or anemia, those under the influence of alcohol, and those at high altitudes.

Propane/LP gas and natural gas are both odorless. An odor-making agent is added to each of these gases. The odor helps you detect a gas leak. However, the odor added to these gases can fade. Gas may be present even though no odor exists.

Make certain you read and understand all warnings. Keep this manual for reference. It is your guide to safe and proper operation of this heater.

 WARNING: Any change to this heater or its controls can be dangerous.

 WARNING: Do not allow fans to blow directly into the fireplace. Avoid any drafts that alter burner flame patterns. Ceiling fans can create drafts that alter burner flame patterns. Altered burner patterns can cause sooting.

 WARNING: Do not use a blower insert, heat exchanger insert, or other accessory not approved for use with this heater.

Due to high temperatures, the appliance should be located out of traffic and away from furniture and draperies.

Do not place clothing or other flammable material on or near the appliance. Never place any objects on the heater.

Heater base assembly becomes very hot when running heater. Keep children and adults away from hot surface to avoid burns or clothing ignition. Heater will remain hot for a time after shutdown. Allow surface to cool before touching.

Carefully supervise young children when they are in the room with heater. When using the hand-held remote accessory, keep selector switch in the OFF position to prevent children from turning on burners with remote.

You must operate this heater with a fireplace screen in place. Make sure fireplace screen is closed before running heater.

SAFETY INFORMATION

Continued

Keep the appliance area clear and free from combustible materials, gasoline, and other flammable vapors and liquids.

- This appliance is only for use with the type of gas indicated on the rating plate. This appliance is not convertible for use with other gases.
- Do not place propane/LP supply tank(s) inside any structure. Locate propane/LP supply tank(s) outdoors.
- To prevent performance problems, the use of a propane/LP tank of less than 100 lbs. capacity is not recommended.
- If you smell gas
 - shut off gas supply
 - do not try to light any appliance
 - do not touch any electrical switch; do not use any phone in your building
 - immediately call your gas supplier from a neighbor's phone. Follow the gas supplier's instructions
 - if you cannot reach your gas supplier, call the fire department
- This heater shall not be installed in a bedroom or bathroom unless installed as a vented appliance (see *Installing Damper Clamp Accessory for Vented Operation*, page 10).
- Before installing in a solid fuel burning fireplace, the chimney flue and firebox must be cleaned of soot, creosote, ashes and loose paint by a qualified chimney cleaner. Creosote will ignite if highly heated. Inspect chimney flue for damage. If damaged, operate heater with flue damper closed.
- If fireplace has glass doors, never operate this heater with glass doors closed. If you operate heater with doors closed, heat buildup inside fireplace will cause glass to burst. Also if fireplace opening has vents at the bottom, you must open the vents before operating heater.
- This log heater is designed to be smokeless. If logs ever appear to smoke, turn off heater and call a qualified service person. **Note:** During initial operation, slight smoking could occur due to log curing and heater burning manufacturing residues.
- To prevent the creation of soot, follow the instructions in *Cleaning and Maintenance*, page 17.
- Before using furniture polish, wax, carpet cleaner, or similar products, turn heater off. If heated, the vapors from these products may create a white powder residue within burner box or on adjacent walls or furniture.
- This heater needs fresh, outside air ventilation to run properly. This heater has an oxygen depletion sensing (ODS) pilot light safety system. The ODS shuts down the heater if not enough fresh air is available. See *Air for Combustion and Ventilation*, pages 4 through 6. If heater keeps shutting off, see *Troubleshooting*, pages 18 through 20.
- Do not run heater
 - where flammable liquids or vapors are used or stored
 - under dusty conditions
- Do not use this heater to cook food or burn paper or other objects.
- Do not use heater if any part has been exposed to or under water. Immediately call a qualified service technician to inspect the room heater and to replace any part of the control system and any gas control which has been under water.
- Do not operate heater if any log is broken. Do not operate heater if a log is chipped (dime-sized or larger).
- Turn heater off and let cool before servicing, installing, or repairing. Make sure the selector switch is in the OFF position. Only a qualified service person should install, service, or repair heater.
- Make sure the selector switch is in the OFF position when you are away from home for long periods of time.
- This heater must not be connected to any external electrical source.
- Operating heater above elevations of 4,500 feet could cause pilot outage.
- Provide adequate clearances around air openings.

PRODUCT IDENTIFICATION

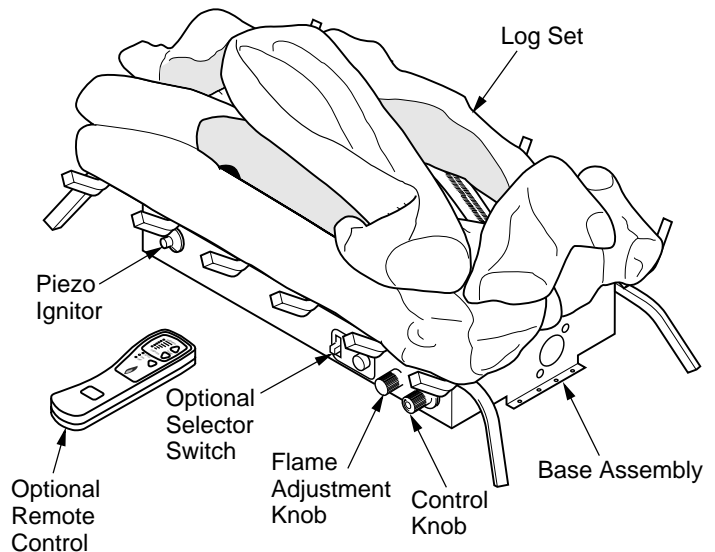

Figure 1 - Product Identification

LOCAL CODES

Install and use heater with care. Follow all local codes. In the absence of local codes, use the latest edition of *The National Fuel Gas Code, ANSI Z223.1/NFPA 54**.

*Available from:

American National Standards Institute, Inc.
 1430 Broadway
 New York, NY 10018

National Fire Protection Association, Inc.
 Batterymarch Park
 Quincy, MA 02269

Note: Where listed vented decorative logs are required, thermostat operation is not permitted.

UNPACKING

⚠ WARNING: Do not remove the data plates from the grate assembly. The data plates contain important product information.

1. Remove logs and heater base assembly from carton. **Note:** Do not pick up heater base assembly by the burner. This could damage heater. Always handle base assembly by grate.
2. Remove all protective packaging applied to logs and heater for shipment.
3. Check all items for any shipping damage. If damaged, promptly inform dealer where you bought heater.

PRODUCT FEATURES

OPERATION

This heater is clean burning. It requires no outside venting. There is no heat loss out a vent or up a chimney. Heat is generated by realistic, dancing yellow flames. This heater is designed for vent-free operation with flue damper closed. It has been tested and approved to ANSI Z21.11.2 standard for unvented heaters. State and local codes in some areas prohibit the use of vent-free heaters. This heater may also be operated as a vented decorative product (ANSI Z21.60) by opening flue damper (non-thermostat operation only).

APPLICATION

These multisided logs are designed to be equally beautiful when viewed from any angle.

They are designed specifically for use in see-through, peninsula, and island fireboxes with multiple openings. You may also install this log heater in a standard firebox.

SAFETY PILOT

This heater has a pilot with an Oxygen Depletion Sensing (ODS) safety shutoff system. The ODS/pilot is a required feature for vent-free room heaters. The ODS/pilot shuts off the heater if there is not enough fresh air.

PIEZO IGNITION SYSTEM

This heater has a piezo ignitor. This system requires no matches, batteries, or other sources to light heater.

REMOTE CONTROL ACCESSORIES

There are four optional remote controls that can be purchased separately for this log heater:

- wall switch
- wall thermostat
- hand-held ON/OFF remote
- hand-held thermostat remote

See *Accessories*, page 24.

NOTE: The wall thermostat or hand-held thermostat may not be used where vented decorative listing is required.

AIR FOR COMBUSTION AND VENTILATION

⚠ WARNING: This heater shall not be installed in a confined space or unusually tight construction unless provisions are provided for adequate combustion and ventilation air. Read the following instructions to insure proper fresh air for this and other fuel-burning appliances in your home.

Today's homes are built more energy efficient than ever. New materials, increased insulation, and new construction methods help reduce heat loss in homes. Home owners weather strip and caulk around windows and doors to keep the cold air out and the warm air in. During heating months, home owners want their homes as airtight as possible.

While it is good to make your home energy efficient, your home needs to breathe. Fresh air must enter your home. All fuel-burning appliances need fresh air for proper combustion and ventilation.

Exhaust fans, fireplaces, clothes dryers, and fuel burning appliances draw air from the house to operate. You must provide adequate fresh air for these appliances. This will insure proper venting of vented fuel-burning appliances.

AIR FOR COMBUSTION AND VENTILATION

Continued

PROVIDING ADEQUATE VENTILATION

The following are excerpts from *National Fuel Gas Code, ANSI Z223.1/NFPA 54, Section 5.3, Air for Combustion and Ventilation.*

All spaces in homes fall into one of the three following ventilation classifications:

1. Unusually Tight Construction
2. Unconfined Space
3. Confined Space

The information on pages 4 through 6 will help you classify your space and provide adequate ventilation.

Unusually Tight Construction

The air that leaks around doors and windows may provide enough fresh air for combustion and ventilation. However, in buildings of unusually tight construction, you must provide additional fresh air.

Unusually tight construction is defined as construction where:

- a. walls and ceilings exposed to the outside atmosphere have a continuous water vapor retarder with a rating of one perm (6×10^{-11} kg per pa-sec-m²) or less with openings gasketed or sealed **and**
- b. weather stripping has been added on openable windows and doors **and**
- c. caulking or sealants are applied to areas such as joints around window and door frames, between sole plates and floors, between wall-ceiling joints, between wall panels, at penetrations for plumbing, electrical, and gas lines, and at other openings.

If your home meets all of the three criteria above, you must provide additional fresh air. See *Ventilation Air From Outdoors*, page 6.

If your home does not meet all of the three criteria above, proceed to *Determining Fresh-Air Flow For Heater Location*, column 2.

Confined and Unconfined Space

The *National Fuel Gas Code, ANSI Z223.1/NFPA 54* defines a confined space as a space whose volume is less than 50 cubic feet per 1,000 Btu per hour (4.8 m³ per kw) of the aggregate input rating of all appliances installed in that space and an unconfined space as a space whose volume is not less than 50 cubic feet per 1,000 Btu per hour (4.8 m³ per kw) of the aggregate input rating of all appliances installed in that space. Rooms communicating directly with the space in which the appliances are installed*, through openings not furnished with doors, are considered a part of the unconfined space.

* Adjoining rooms are communicating only if there are doorless passageways or ventilation grills between them.

DETERMINING FRESH-AIR FLOW FOR HEATER LOCATION

Determining if You Have a Confined or Unconfined Space

Use this work sheet to determine if you have a confined or unconfined space.

Space: Includes the room in which you will install heater plus any adjoining rooms with doorless passageways or ventilation grills between the rooms.

1. Determine the volume of the space (length x width x height).
 Length x Width x Height = _____ cu. ft. (volume of space)
Example: Space size 20 ft. (length) x 16 ft. (width) x 8 ft. (ceiling height) = 2560 cu. ft. (volume of space)
 If additional ventilation to adjoining room is supplied with grills or openings, add the volume of these rooms to the total volume of the space.
2. Multiply the space volume by 20 to determine the maximum Btu/Hr the space can support.

$$\text{_____ (volume of space) x 20 = (Maximum Btu/Hr the space can support)}$$

Example: 2560 cu. ft. (volume of space) x 20 = 51,200 (maximum Btu/Hr the space can support)

3. Add the Btu/Hr of all fuel burning appliances in the space.

Vent-free heater	_____ Btu/Hr
Gas water heater*	_____ Btu/Hr
Gas furnace	_____ Btu/Hr
Vented gas heater	_____ Btu/Hr
Gas fireplace logs	_____ Btu/Hr
Other gas appliances* +	_____ Btu/Hr
Total	= _____ Btu/Hr

* Do not include direct-vent gas appliances. Direct-vent draws combustion air from the outdoors and vents to the outdoors.

Example:

Gas water heater	_____ 40,000 Btu/Hr
Vent-free heater	+ _____ 33,000 Btu/Hr
Total	= _____ 73,000 Btu/Hr

4. Compare the maximum Btu/Hr the space can support with the actual amount of Btu/Hr used.

$$\text{_____ Btu/Hr (maximum the space can support)}$$

$$\text{_____ Btu/Hr (actual amount of Btu/Hr used)}$$

Example: 51,200 Btu/Hr (maximum the space can support)
 73,000 Btu/Hr (actual amount of Btu/Hr used)

The space in the above example is a confined space because the actual Btu/Hr used is more than the maximum Btu/Hr the space can support. You must provide additional fresh air. See next page for your options.

AIR FOR COMBUSTION AND VENTILATION

Continued

- Rework worksheet, adding the space of an adjoining room. If the extra space provides an unconfined space, remove door to adjoining room or add ventilation grills between rooms. See *Ventilation Air From Inside Building* below.
- Vent room directly to the outdoors. See *Ventilation Air From Outdoors*.
- Install a lower Btu/Hr heater, if lower Btu/Hr size makes room unconfined.

If the actual Btu/Hr used is less than the maximum Btu/Hr the space can support, the space is an unconfined space. You will need no additional fresh air ventilation.

WARNING: If the area in which the heater may be operated is smaller than that defined as an unconfined space or if the building is of unusually tight construction, provide adequate combustion and ventilation air by one of the methods described in the *National Fuel Gas Code, ANSI Z223.1/NFPA 54, Section 5.3* or applicable local codes.

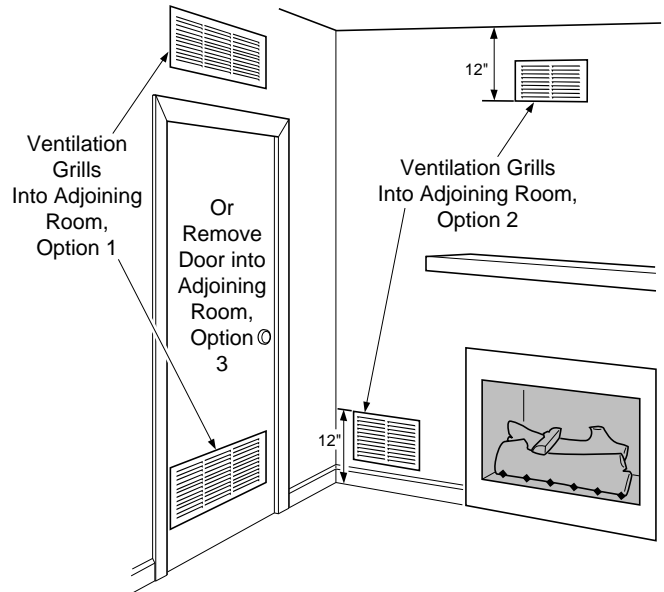

Figure 2 - Ventilation Air from Inside Building

VENTILATION AIR

Ventilation Air From Inside Building

This fresh air would come from an adjoining unconfined space. When ventilating to an adjoining unconfined space, you must provide two permanent openings: one within 12" of the ceiling and one within 12" of the floor on the wall connecting the two spaces (see options 1 and 2, Figure 2). You can also remove door into adjoining room (see option 3, Figure 2). Follow the *National Fuel Gas Code, ANSI Z223.1/NFPA 54, Section 5.3, Air for Combustion and Ventilation* for required size of ventilation grills or ducts.

Ventilation Air From Outdoors

Provide extra fresh air by using ventilation grills or ducts. You must provide two permanent openings: one within 12" of the ceiling and one within 12" of the floor. Connect these items directly to the outdoors or spaces open to the outdoors. These spaces include attics and crawl spaces. Follow the *National Fuel Gas Code, ANSI Z223.1/NFPA 54, Section 5.3, Air for Combustion and Ventilation* for required size of ventilation grills or ducts.

IMPORTANT: Do not provide openings for inlet or outlet air into attic if attic has a thermostat-controlled power vent. Heated air entering the attic will activate the power vent.

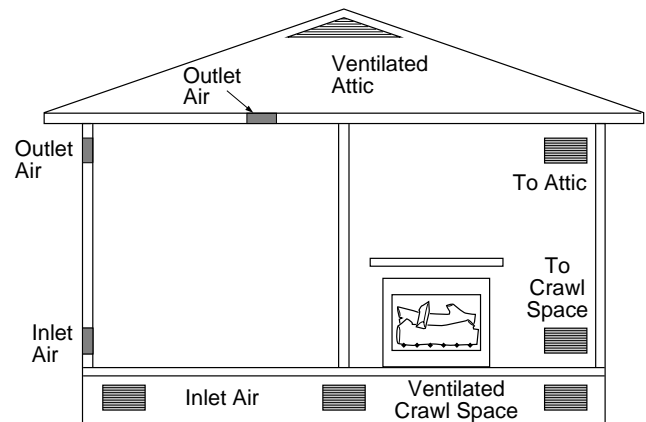

Figure 3 - Ventilation Air from Outdoors

INSTALLATION

NOTICE: This heater is intended for use as supplemental heat. Use this heater along with your primary heating system. Do not install this heater as your primary heat source. If you have a central heating system, you may run system's circulating blower while using heater. This will help circulate the heat throughout the house. In the event of a power outage, you can use this heater as your primary heat source.

⚠ WARNING: A qualified service person must install heater. Follow all local codes.

NOTICE: State or local codes may only allow operation of this appliance in a vented configuration. Check your state or local codes.

⚠ WARNING: Before installing in a solid fuel burning fireplace, the chimney flue and firebox must be cleaned of soot, creosote, ashes and loose paint by a qualified chimney cleaner. Creosote will ignite if highly heated. A dirty chimney flue may create and distribute soot within the house. Inspect chimney flue for damage. If damaged, operate heater with flue damper closed.

⚠ WARNING: Seal any fresh air vents or ash clean-out doors located on floor or wall of fireplace. If not, drafting may cause pilot outage or sooting. Use a heat-resistant sealant. Do not seal chimney flue damper.

⚠ WARNING: Never install the heater

- in a bedroom or bathroom unless installed as a vented appliance, see page 10
- in a recreational vehicle
- where curtains, furniture, clothing, or other flammable objects are less than 42 inches from the front, top, or sides of the heater
- in high traffic areas
- in windy or drafty areas

⚠ CAUTION: This heater creates warm air currents. These currents move heat to wall surfaces next to heater. Installing heater next to vinyl or cloth wall coverings or operating heater where impurities (such as, but not limited to, tobacco smoke, aromatic candles, cleaning fluids, oil or kerosene lamps, etc.) in the air exist, may discolor walls or cause odors.

IMPORTANT: Vent-free heaters add moisture to the air. Although this is beneficial, installing heater in rooms without enough ventilation air may cause mildew to form from too much moisture. See *Air for Combustion and Ventilation*, pages 4 through 6.

CHECK GAS TYPE

Use only the correct type of gas (natural or propane/LP). If your gas supply is not the correct gas type, do not install heater. Call dealer where you bought heater for proper type heater.

INSTALLATION AND CLEARANCES (Vent-Free Operation Only)

⚠ WARNING: Maintain the minimum clearances. If you can, provide greater clearances from floor, ceiling, and adjoining wall.

MINIMUM FIREPLACE CLEARANCE TO COMBUSTIBLE MATERIALS		
Log Size	Side Wall	Ceiling
27"	16"	42"

LOG SIZING REQUIREMENTS			
Log Size	Minimum Firebox		
	Height	Depth	Width
27"	17"	19"	32"

Carefully follow the instructions starting on page 8. This will ensure safe installation into a masonry, UL127-listed manufactured fireplace, or listed vent-free firebox.

INSTALLATION

Continued

Minimum Clearances For Side Combustible Material, Side Wall, and Ceiling

- A. Clearances from the side of the fireplace cabinet to any combustible material and wall should follow diagram in Figure 4.

Example: The face of a mantel, bookshelf, etc. is made of combustible material and protrudes 3 1/2" from the wall. This combustible material must be 4" from the side of the fireplace cabinet (see Figure 4).

Note: When installing your gas logs into a manufactured firebox, follow firebox manufacturer's instructions for minimum clearances to combustible materials.

- B. Clearances from the top of the fireplace opening to the ceiling should not be less than 42 inches.

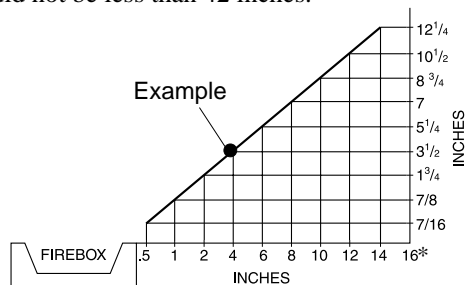

*Minimum 16 inches from Side Wall

Figure 4 - Minimum Clearance for Combustible to Wall

NOTICE: Manual control heaters may be used as a vented product. If so, you must always run heater with chimney flue damper open. If running heater with damper open, noncombustible material above fireplace opening is not needed. Go to *Installing Damper Clamp Accessory for Vented Operation*, page 10.

Minimum Noncombustible Material Clearances

If Not Using Mantel

Note: If using a mantel, proceed to *If Using Mantel*. If not using a mantel, follow the information below.

You must have noncombustible material(s) above both fireplace openings. Noncombustible materials (such as slate, marble, tile, etc.) must be at least 1/2 inch thick. With sheet metal, you must have noncombustible material behind it. Noncombustible material must extend at least 8" up (for all models). If noncombustible material is less than 12", you must install the fireplace hood accessory. See Figure 5 at right for minimum clearances.

IMPORTANT: If you cannot meet these minimum clearances, you must operate heater with chimney flue damper open. Go to *Installing Damper Clamp Accessory for Vented Operation*, page 10.

If Using Mantel

You must have noncombustible material(s) above the fireplace opening. Noncombustible materials (such as slate, marble, tile, etc.) must be at least 1/2 inch thick. With sheet metal, you must have noncombustible material behind it. Noncombustible material must extend at least 8 inches up (for all models). If noncombustible material is less than 12", you must install the fireplace hood accessory. Even if noncombustible material is more than 12", you may need the hood accessory to deflect heat away from your mantel shelf. See Figure 5 and Figures 6 and 7, page 9, for minimum clearances.

Noncombustible Material Distance (A)	Requirements for Safe Installation
12" or more	Noncombustible material OK.
Between 8" and 12"	Install fireplace hood accessory (GA6050, GA6052 or GA6053, see <i>Accessories</i> , page 24).
Less than 8"	Noncombustible material must be extended to at least 8". See <i>Between 8" and 12"</i> , above. If you cannot extend material, you must operate heater with flue damper open.

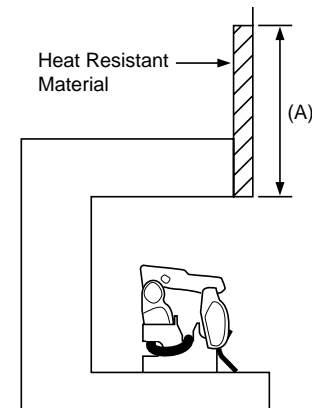

Figure 5 - Heat Resistant Material (Slate, Marble, Tile, etc.) Above Fireplace

INSTALLATION

Continued

MANTEL CLEARANCES

In addition to meeting noncombustible material clearances, you must also meet required clearances between fireplace openings and mantel shelf on each side of the fireplace. If you do not meet the clearances listed in this section, you will need a hood.

Determining Minimum Mantel Clearance

If you meet minimum clearance between mantel shelf and top of fireplace opening, a hood is not required (see Figure 6).

Determining Minimum Mantel Clearance When using a Hood

If minimum clearances in Figure 6 are not met, you must have a hood. When using a hood there are still certain minimum mantel clearances required. Follow minimum clearances shown in Figure 7 when using hood.

NOTICE: Surface temperatures of adjacent walls and mantels become hot during operation. Walls and mantels above the firebox may become hot to the touch. If installed properly, these temperatures meet the requirement of the national product standard. Follow all minimum clearances shown in this manual.

NOTICE: If your installation does not meet the minimum clearances shown, you must do one of the following:

- operate the logs only with the flue damper open
- raise the mantel to an acceptable height
- remove the mantel

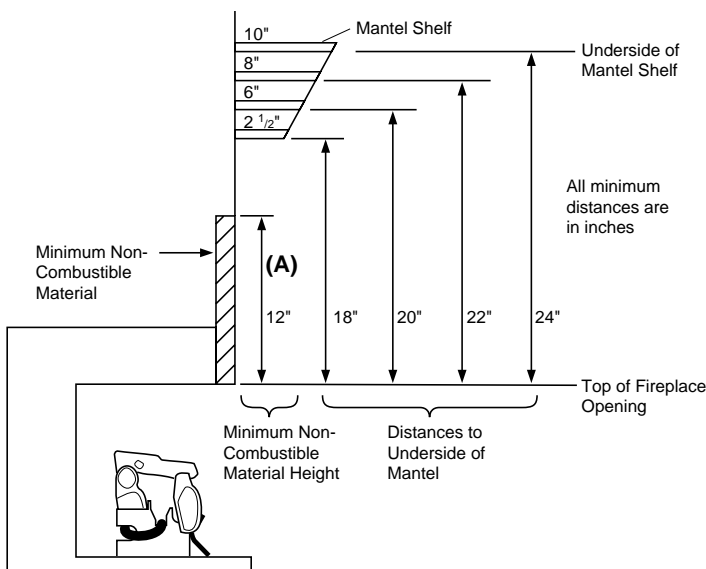

Figure 6 - Minimum Mantel Clearances Without Using Hood

FLOOR CLEARANCES

- A. If installing appliance on the floor level, you must maintain the minimum distance of 14" to combustibles (see Figure 8).
- B. If combustible materials are less than 14" to the fireplace, you must install appliance at least 5" above the combustible flooring (see Figure 9).

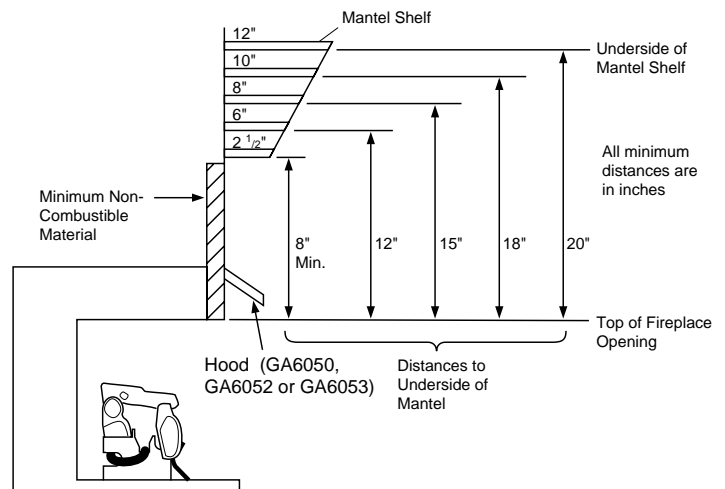

Figure 7 - Minimum Mantel Clearances When Using Hood

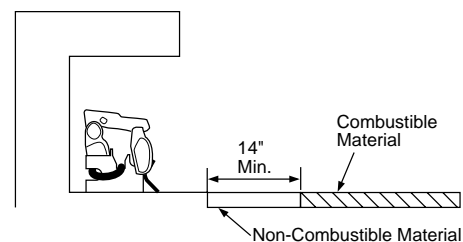

Figure 8 - Minimum Fireplace Clearances If Installed at Floor Level

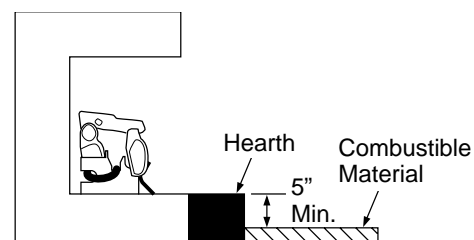

Figure 9 - Minimum Fireplace Clearances Above Combustible Flooring

INSTALLATION

Continued

INSTALLING DAMPER CLAMP ACCESSORY FOR VENTED OPERATION

Note: When used as a vented heater, appliance must be installed only in a solid-fuel burning fireplace with a working flue and constructed of noncombustible material.

If your heater is a manually controlled model, you may use this heater as a vented product. There are three reasons for operating your heater in the vented mode:

1. The fireplace does not meet the clearance to combustibles requirements for vent-free operation
2. State or local codes do not permit vent-free operation
3. You prefer vented operation

If reasons number 1 or 2 above apply to you, you must permanently open chimney flue damper. You must install the damper clamp accessory (to order, see *Accessories*, page 24). This will insure vented operation (see Figure 10). The damper clamp will keep damper open. Installation instructions are included with clamp accessory.

See chart below for minimum permanent flue opening you must provide. Attach damper clamp so the minimum permanent flue opening will be maintained at all times.

Chimney Height (ft.)	Minimum Permanent Flue Opening (sq. ins.)
6' to 15'	39 sq. inches
15' to 30'	29 sq. inches

Area of Various Standard Round Flues	
Diameter (ins.)	Area (sq. ins.)
5"	20 sq. inches
6"	29 sq. inches
7"	39 sq. inches
8"	51 sq. inches

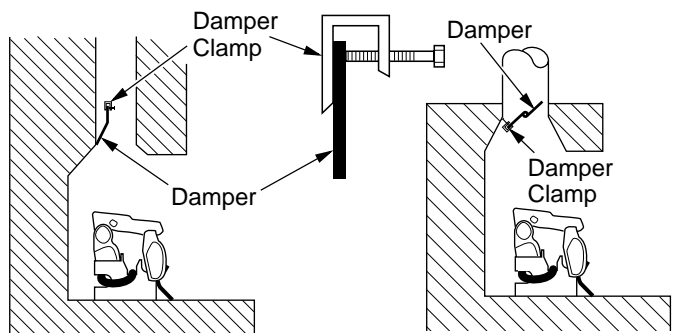

Figure 10 - Attaching Damper Clamp

INSTALLING HEATER BASE ASSEMBLY

WARNING: Do not remove the data plates attached to the heater base assembly. The data plates contain important warranty and safety information.

WARNING: You must secure this heater to fireplace floor. If not, heater will move when you adjust controls. Moving heater may cause a gas leak.

WARNING: If installing in a sunken fireplace, special care is needed. You must raise the fireplace floor to allow access to heater control panel. This will insure adequate air flow and guard against sooting and controls being damaged. Raise fireplace floor with non-combustible material. Make sure material is secure.

CAUTION: Do not pick up heater base assembly by the burner. This could damage heater. Only handle base assembly by grates.

IMPORTANT: Make sure the heater burner is level. If heater is not level, heater will not work properly.

Installation Items Needed

- hardware package (provided with heater)
 - approved flexible gas hose (not provided) (if allowed by local codes)
 - sealant (resistant to propane/LP gas, not provided)
 - electric drill with 3/16" drill bit (metal or masonry as applicable)
 - flathead screwdriver
1. Apply pipe joint sealant lightly to male NPT threads of the fitting to be threaded into gas control. Connect approved flexible gas hose to gas control fitting in heater (see Figure 11). **IMPORTANT:** Hold gas fitting with wrench when connecting flexible gas hose.
 2. Locate two masonry screws in hardware package.
 3. Place heater base in fireplace.

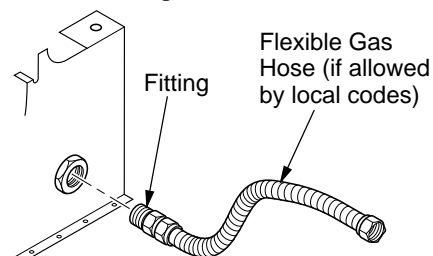

Figure 11 - Attaching Flexible Gas Hose to Heater

For more information, visit www.desatech.com

INSTALLATION

Continued

4. Place logs in their proper position on heater base. See *Installing Logs*, page 13.
5. Center heater base and logs front-to-back and side-to-side in fireplace.
6. Carefully remove logs without moving heater base.
7. Mark screw locations through one hole on each side of the mounting bracket (see Figure 12). If installing in a brick-bottom fireplace, mark screw locations in mortar joint of bricks.
8. Remove heater base from fireplace. If installing optional control accessories, do so at this time. Follow all directions provided with accessory.
9. Drill holes at marked locations using 3/16" drill bit.
10. Attach base assembly to fireplace floor using two masonry screws (in hardware package).

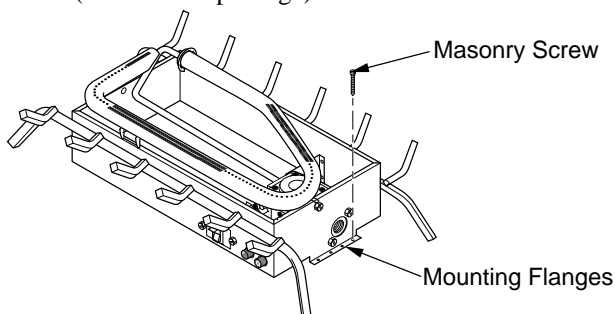

Figure 12 - Attaching Base Assembly to Fireplace Floor

CONNECTING TO GAS SUPPLY

WARNING: A qualified service person must connect heater to gas supply. Follow all local codes.

WARNING: Never connect propane/LP heater directly to the propane/LP supply. This heater requires an external regulator (not supplied). Install the external regulator between the heater and propane/LP supply.

WARNING: Never connect natural gas heater to private (non-utility) gas wells. This gas is commonly known as wellhead gas.

Installation Items Needed

Before installing heater, make sure you have the items listed below.

- external regulator (for propane/LP units only, supplied by installer)
- piping (check local codes)
- sealant (resistant to propane/LP gas)
- equipment shutoff valve *
- test gauge connection *
- sediment trap
- tee joint
- pipe wrench

* A CSA design-certified equipment shutoff valve with 1/8" NPT tap is an acceptable alternative to test gauge connection. Purchase the optional CSA design-certified equipment shutoff valve from your dealer. See *Accessories*, page 24.

For propane/LP units, the installer must supply an external regulator. The external regulator will reduce incoming gas pressure. You must reduce incoming gas pressure to between 11 and 14 inches of water. If you do not reduce incoming gas pressure, heater regulator damage could occur. Install external regulator with the vent pointing down as shown in Figure 13. Pointing the vent down protects it from freezing rain or sleet.

CAUTION: Use only new, black iron or steel pipe. Internally-tinned copper tubing may be used in certain areas. Check your local codes. Use pipe of 1/2" diameter or greater to allow proper gas volume to heater. If pipe is too small, undue loss of volume will occur.

Installation must include an equipment shutoff valve, union, and plugged 1/8" NPT tap. Locate NPT tap within reach for test gauge hook up. NPT tap must be upstream from heater (see Figure 14, page 12).

IMPORTANT: Install equipment shutoff valve in an accessible location. The equipment shutoff valve is for turning on or shutting off the gas to the appliance.

Check your building codes for any special requirements for locating equipment shutoff valve to fireplaces.

Apply pipe joint sealant lightly to male NPT threads. This will prevent excess sealant from going into pipe. Excess sealant in pipe could result in clogged heater valves.

WARNING: Use pipe joint sealant that is resistant to liquid petroleum (LP) gas.

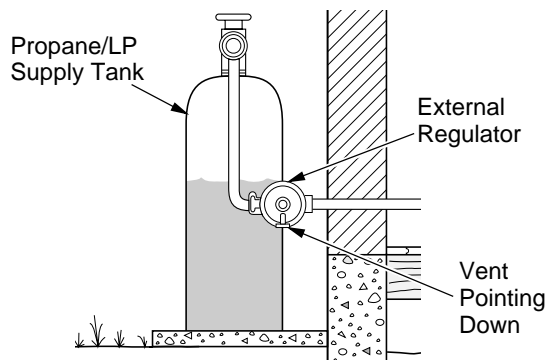

Figure 13 - External Regulator With Vent Pointing Down (propane/LP gas only)

INSTALLATION

Continued

We recommend that you install sediment trap in supply line as shown in Figure 14. Locate sediment trap where it is within reach for cleaning. Install in piping system between fuel supply and heater. Locate sediment trap where trapped matter is not likely to freeze. A sediment trap traps moisture and contaminants. This keeps them from going into heater controls. If sediment trap is not installed or is installed wrong, heater may not run properly.

CAUTION: Avoid damage to control. Hold fitting with wrench when connecting it to gas piping and/or fittings.

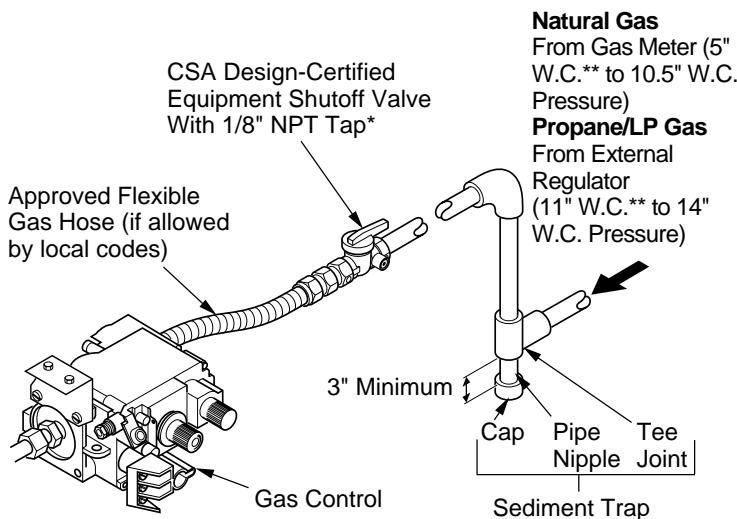

Figure 14 - Gas Connection

* Purchase the optional CSA design-certified equipment shutoff valve from your dealer. See *Accessories*, page 24.

** Minimum inlet pressure for purpose of input adjustment.

CHECKING GAS CONNECTIONS

WARNING: Test all gas piping and connections for leaks after installing or servicing. Correct all leaks at once.

WARNING: Never use an open flame to check for a leak. Apply a noncorrosive leak detection fluid to all joints. Bubbles forming show a leak. Correct all leaks at once.

CAUTION: For propane/LP gas, make sure external regulator has been installed between propane/LP supply and heater. See guidelines under *Connecting to Gas Supply*, page 11.

Pressure Testing Gas Supply Piping System

Test Pressures In Excess Of 1/2 PSIG (3.5 kPa)

1. Disconnect appliance with its appliance main gas valve (control valve) and equipment shutoff valve from gas supply piping system. Pressures in excess of 1/2 psig will damage heater regulator.
2. Cap off open end of gas pipe where equipment shutoff valve was connected.
3. Pressurize supply piping system by either opening propane/LP supply tank valve for propane/LP gas, or opening main gas valve located on or near gas meter for natural gas, or using compressed air.
4. Check all joints of gas supply piping system. Apply a noncorrosive leak detection fluid to gas joints. Bubbles forming show a leak.
5. Correct all leaks at once.
6. Reconnect heater and equipment shutoff valve to gas supply. Check reconnected fittings for leaks.

Test Pressures Equal To or Less Than 1/2 PSIG (3.5 kPa)

1. Close equipment shutoff valve (see Figure 15).
2. Pressurize supply piping system by either opening propane/LP supply tank valve for propane/LP gas, or opening main gas valve located on or near gas meter for natural gas, or using compressed air.
3. Check all joints from propane/LP supply tank to equipment shutoff valve (see Figure 15). Apply a noncorrosive leak detection fluid to gas joints. Bubbles forming show a leak.
4. Correct all leaks at once.

Pressure Testing Heater Gas Connections

1. Open equipment shutoff valve (see Figure 15, page 12).
2. Open main gas valve located on or near gas meter for natural gas or open propane/LP supply tank valve.
3. Make sure control knob of heater is in the OFF position.
4. Check all joints from equipment shutoff valve to control valve (see Figure 16 or 17, page 13). Apply a noncorrosive leak detection fluid to gas joints. Bubbles forming show a leak.
5. Correct all leaks at once.
6. Light heater (see *Operating Heater*, pages 14 through 16). Check all other internal joints for leaks.
7. Turn off heater (see *To Turn Off Gas to Appliance*, page 15).

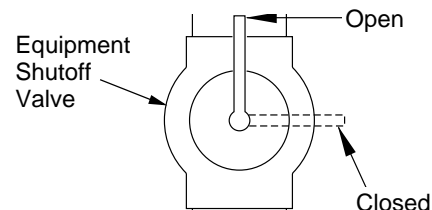

Figure 15 - Equipment Shutoff Valve

INSTALLATION

Continued

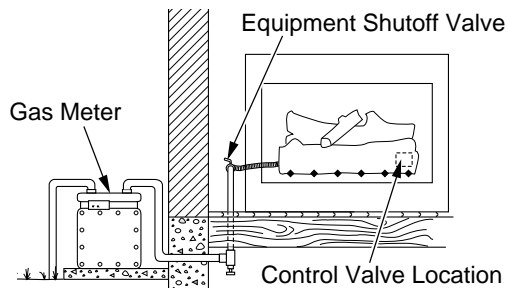

Figure 16 - Checking Gas Joints for Natural Gas

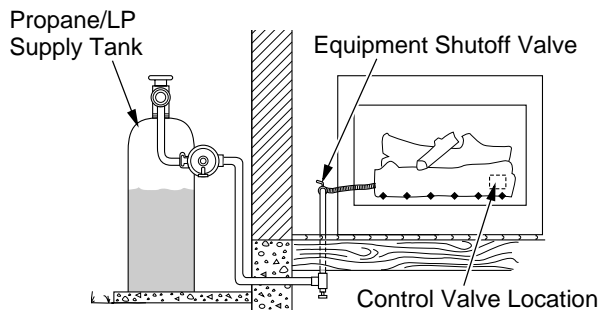

Figure 17 - Checking Gas Joints for Propane/LP Gas

INSTALLING LOGS

⚠ WARNING: Failure to position the parts in accordance with these diagrams or failure to use only parts specifically approved with this heater may result in property damage or personal injury.

⚠ CAUTION: After installation and periodically thereafter, check to ensure that no flame comes in contact with any log. With the heater set to HIGH, check to see if flames contact any log. If so, reposition logs according to the log installation instructions in this manual. Flames contacting logs will create soot.

It is very important to install the logs exactly as instructed. Do not modify logs. Only use logs supplied with heater.

1. Place front log (#1) and rear log (#2) on grate to fit as illustrated in Figure 18.
2. Place center insert log (#3) as illustrated in Figure 19.
3. Place top left log (#4) and top right log (#5) as illustrated in Figure 20.
4. Make sure open areas of logs line up with burner ports (see Figure 21). Logs will fit securely on chassis. **IMPORTANT:** Make sure log does not cover any burner ports.
5. Place lava rock around base of heater if desired.

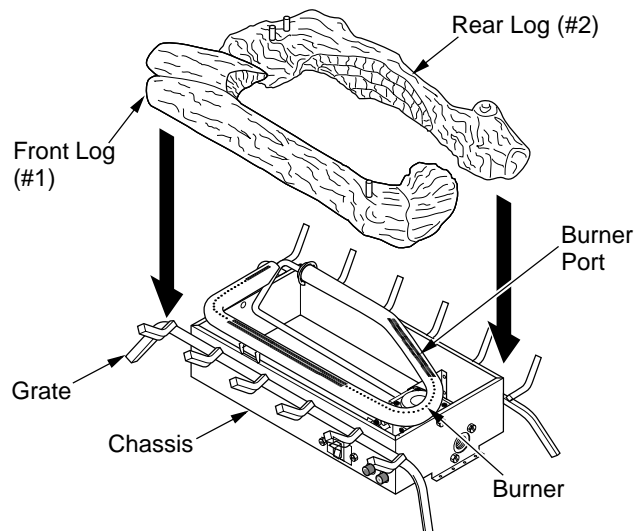

Figure 18 - Installing Front (#1) and Rear (#2) Logs

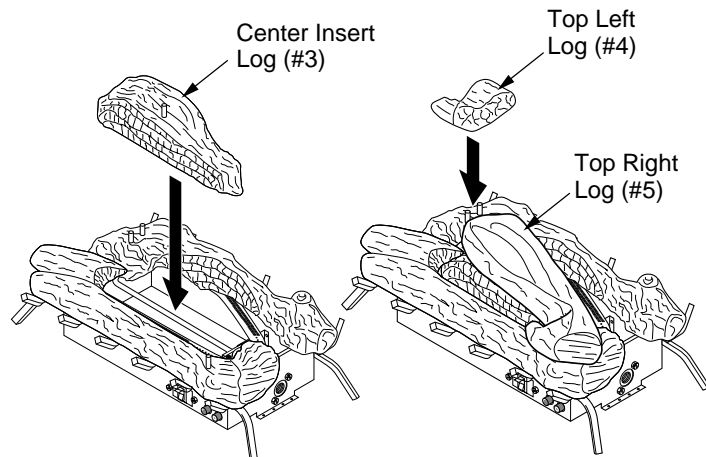

Figure 19 - Installing Center Insert Log (#3) Figure 20 - Installing Top Left (#4) and Top Right (#5) Logs

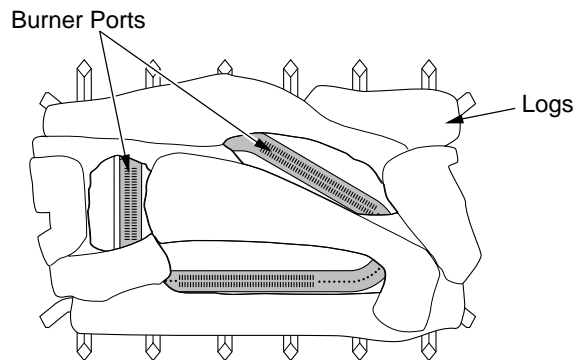

Figure 21 - Installing Log Set (Top View)

OPERATING HEATER

FOR YOUR SAFETY READ BEFORE LIGHTING

⚠ WARNING: If you do not follow these instructions exactly, a fire or explosion may result causing property damage, personal injury or loss of life.

- This appliance has a pilot which must be lighted by hand. When lighting the pilot, follow these instructions exactly.
- BEFORE LIGHTING** smell all around the appliance area for gas. Be sure to smell next to the floor because some gas is heavier than air and will settle on the floor.

WHAT TO DO IF YOU SMELL GAS

- Do not try to light any appliance.
 - Do not touch any electric switch; do not use any phone in your building.
 - Immediately call your gas supplier from a neighbor's phone. Follow the gas supplier's instructions.
 - If you cannot reach your gas supplier, call the fire department.
- Use only your hand to push in or turn the gas control knob. Never use tools. If the knob will not push in or turn by hand, don't try to repair it, call a qualified service technician or gas supplier. Force or attempted repair may result in a fire or explosion.
 - Do not use this appliance if any part has been under water. Immediately call a qualified service technician to inspect the appliance and to replace any part of the control system and any gas control which has been under water.

LIGHTING INSTRUCTIONS

⚠ WARNING:

- If fireplace has glass doors, never operate this heater with glass doors closed. If you operate heater with doors closed, heat buildup inside fireplace will cause glass to burst. Also if fireplace opening has vents at the bottom, you must open the vents before operating heater.
- You must operate this heater with a fireplace screen in place. Make sure fireplace screen is closed before running heater.



NOTICE: During initial operation of new heater, burning logs will give off a paper-burning smell. Open damper or window to vent smell. This will only last a few hours.

Note: Homeowners generally prefer to operate their heater with the chimney damper closed. This will put all the heat into the room. However, there may be times you will desire the full flames of the HI heat setting but will find the heat output excessive. You can open the chimney damper (if you have one) fully or partially to release some of the heat.

⚠ WARNING: Damper handle will be hot if heater has been running.

- STOP!** Read the safety information, column 1.
- Make sure equipment shutoff valve is fully open.
- Set switch in OFF position.

⚠ WARNING: Burner will come on automatically within one minute when the selector switch is in the ON position after the pilot is lit.

- Press in and turn control knob clockwise  to the OFF position.
- Wait five (5) minutes to clear out any gas. Then smell for gas, including near the floor. If you smell gas, STOP! Follow "B" in the safety information, column 1. If you don't smell gas, go to the next step.
- Press in and turn control knob counterclockwise  to the PILOT position. Press in control knob for five (5) seconds (see Figure 22).

Note: You may be running this heater for the first time after hooking up to gas supply. If so, the control knob may need to be pressed in for 30 seconds or more. This will allow air to bleed from the gas system.

- With control knob pressed in, press and release ignitor button. This will light pilot. The pilot is attached to the front burner. If needed, keep pressing ignitor button until pilot lights.

Note: If pilot does not stay lit, contact a qualified service person or gas supplier for repairs. Until repairs are made, light pilot with match. To light pilot with match, see *Manual Lighting Procedure* on page 15.

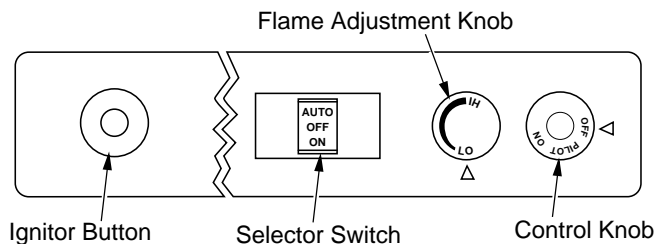

Figure 22 - Control Knob and Ignitor Button Location (Shown as Supplied, No Control Options)

OPERATING HEATER

Continued

8. Keep control knob pressed in for 30 seconds after lighting pilot. After 30 seconds, release control knob.
 - If control knob does not pop out when released, contact a qualified service person or gas supplier for repairs.
Note: If pilot goes out, repeat steps 4 through 8.
9. Slightly push in and turn control knob counterclockwise to the ON position.
10. Wait one minute and switch selector switch to the ON position to light burner. **Note:** AUTO is only functional when using GWMT1, or GWMS2 optional accessories.
11. Set flame adjustment knob to any level between HI and LO.

CAUTION: Do not try to adjust heating levels by using the equipment shutoff valve.

WARNING: Make sure the selector switch is in the OFF position when you are away from home for long periods of time. Heater will come on automatically with selector switch in the ON position.

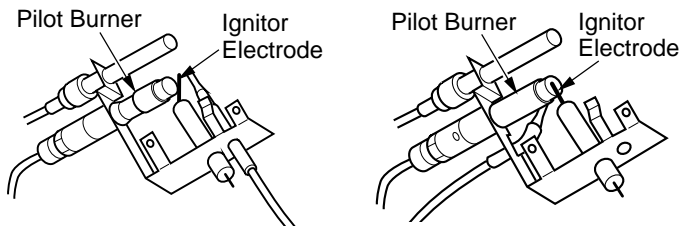

Figure 23 - Natural Gas Pilot Figure 24 - Propane/LP Gas Pilot

TO TURN OFF GAS TO APPLIANCE

Shutting Off Heater

1. Turn control knob clockwise to the OFF position.
- 2a. Set selector switch in the OFF position.
- 2b. If Using Optional Hand-Held Remote: Set selector switch in the OFF position to prevent draining battery.

Shutting Off Burner Only (pilot stays lit)

You may shut off the burner and keep the pilot lit by doing one of the following:

1. Turn control knob clockwise to the PILOT position.
2. Use remote control manual OFF button.
3. Set selector switch in the OFF position.

MANUAL LIGHTING PROCEDURE

1. Follow steps 1 through 6 under *Lighting Instructions*, page 14.
2. Depress control knob and light pilot with match.
3. Keep control knob pressed in for 30 seconds after lighting pilot. After 30 seconds, release control knob. Now follow steps 9 through 11, column 1.

OPTIONAL REMOTE OPERATION

Note: All remote control accessories must be purchased separately (see *Accessories*, page 24). Follow instructions included with the remote control.

Thermostat Control Operation

(Optional GHRCTA Series Only) The thermostat control setting on the remote control unit can be set to any comfort level between WARMER and COOLER. The burner will turn on and off automatically to maintain the comfort level you select. The ideal comfort setting will vary by household depending upon the amount of space to be heated, the output of the central heating system, etc.

For wall thermostat operation, follow instructions supplied with thermostat accessory GWMT1. For wall switch operation follow instructions supplied with GWMS2.

NOTICE: You must light the pilot before using the hand-held remote control unit. See *Lighting Instructions* on page 14.

1. After lighting, let pilot flame burn for about one minute. Turn control knob to ON position. Adjust flame adjustment knob anywhere between HI and LO. Slide the selector switch to the REMOTE position. **NOTE:** The burner may light if hand-held remote ON button was on when selector switch was last turned off. You can now turn the burner on and off with the hand-held remote control unit.
IMPORTANT: Do not leave the selector switch in the REMOTE position when the pilot is not lit. This will drain the battery.
IMPORTANT: Be sure to press the ON/OFF buttons on the hand held remote control unit for up to 3 seconds to assure proper operation.

GHRC Series Operation:

- 2a. Press the ON/OFF button to turn the burner on and off. When turning burner off, the pilot will remain lit.

OPERATING HEATER

Continued

GHRCTA Series Operation

2b. Press the AUTO/ON/OFF button on the hand-held remote control (see Figure 26). The lights to the left of the button will show AUTO, ON, or OFF.

- In the ON mode, the burners will ignite. The heater is in manual mode when ON is lit.
- In the AUTO mode, the thermostat in the hand-held remote unit controls the room temperature. To increase the room temperature, press the top arrow of the TEMP button. To lower the room temperature, press the bottom arrow of the TEMP button. At higher settings the heater will run longer.

IMPORTANT: This remote control has been specially engineered to take an air temperature sample every 5.5 minutes in the AUTO mode. It will not respond immediately to the temperature setting being turned up or down.

IMPORTANT: The hand-held remote control unit must be near the heater. Do not keep the hand-held remote control unit too close to the heater. The thermostat on the hand-held remote control unit will heat up too quickly and turn the heater off.

3. To turn the burner off, press the AUTO/ON/OFF button until OFF lights. The pilot will remain lit.

IMPORTANT: To turn the pilot off, manually turn the control knob on the heater to the OFF position.

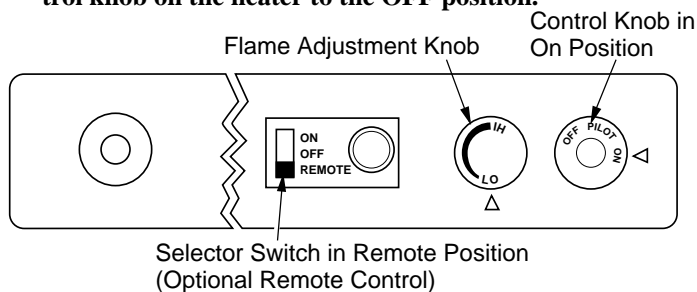

Figure 25 - Setting the Selector Switch, Control Knob, and Flame Adjustment Knob for Remote Operation

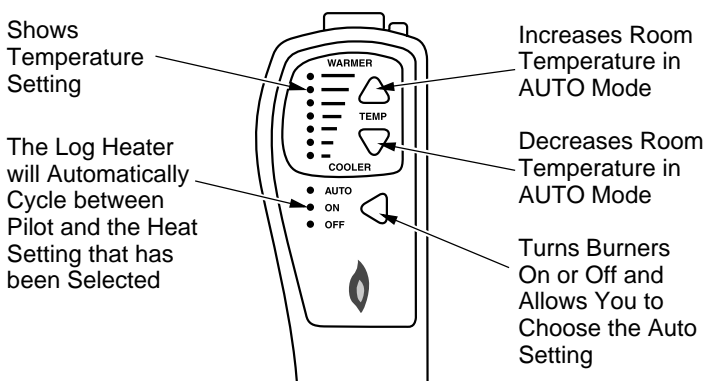

Figure 26 - Thermostat Hand-Held Remote Control Unit Selections (GHRCTA only)

INSPECTING BURNERS

Check pilot flame pattern and burner flame patterns often.

PILOT FLAME PATTERN

Figure 27 shows a correct pilot flame pattern. Figure 28 shows an incorrect pilot flame pattern. The incorrect pilot flame is not touching the thermocouple. When the thermocouple cools, the heater will shut down.

If pilot flame pattern is incorrect, as shown in Figure 28

- turn heater off (see *To Turn Off Gas to Appliance*, page 15)
- see *Troubleshooting*, pages 18 through 20

Note: The pilot flame on natural gas units will have a slight curve, but flame should be blue and have no yellow or orange color.

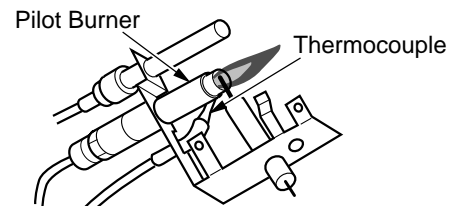

Figure 27 - Correct Pilot Flame Pattern (Propane/LP Pilot Shown)

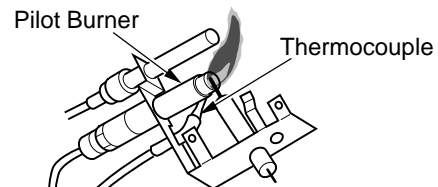

Figure 28 - Incorrect Pilot Flame Pattern (Propane/LP Pilot Shown)

BURNER FLAME PATTERN

Figure 29 shows a correct burner flame pattern. Figure 30 shows an incorrect burner flame pattern. If burner flame pattern is incorrect,

- turn heater off (see *To Turn Off Gas to Appliance*, page 15)
- see *Troubleshooting*, pages 18 through 20

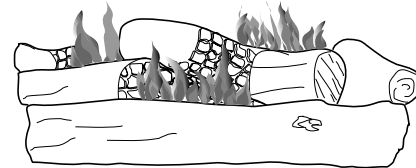

Figure 29 - Correct Flame Pattern

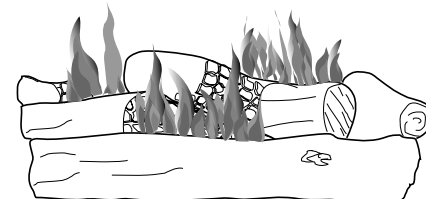

Figure 30 - Incorrect Flame Pattern

INSPECTING BURNERS

Continued

BURNER PRIMARY AIR HOLES

Air is drawn into the burner through the holes in the fitting at the burner entrance. These holes may become blocked with dust or lint. Periodically inspect these holes for any blockage and clean if needed. Blocked air holes will create soot.

MAIN BURNER

Periodically inspect all burner flame holes with the heater running. All slotted burner flame holes should be open with yellow flame present. All round burner flame holes should be open with a small blue flame present. Some burner flame holes may become blocked by debris or rust, with no flame present. If so, turn off heater and let cool. Remove blockage, blocked burner flame holes will create soot.

CLEANING AND MAINTENANCE

WARNING: Turn off heater and let cool before cleaning.

CAUTION: You must keep control areas, burner, and circulating air passageways of heater clean. Inspect these areas of heater before each use. Have heater inspected yearly by a qualified service person. Heater may need more frequent cleaning due to excessive lint from carpeting, bedding material, pet hair, etc.

CLEANING BURNER INJECTOR HOLDER AND PILOT AIR INLET HOLE

The primary air inlet holes allow the proper amount of air to mix with the gas. This provides a clean burning flame. Keep these holes clear of dust, dirt, lint, and pet hair. Clean these air inlet holes prior to each heating season. Blocked air holes will create soot. We recommend that you clean the unit every three months during operation and have heater inspected yearly by a qualified service person.

We also recommend that you keep the burner tube and pilot assembly clean and free of dust and dirt. To clean these parts we recommend using compressed air no greater than 30 PSI. Your local computer store, hardware store, or home center may carry compressed air in a can. You can use a vacuum cleaner in the blow position. If using compressed air in a can, please follow the directions on the can. If you don't follow directions on the can, you could damage the pilot assembly.

1. Shut off the unit, including the pilot. Allow the unit to cool for at least thirty minutes.

2. Inspect burner, pilot, and primary air inlet holes on injector holder for dust and dirt (see Figure 31).
3. Blow air through the ports/slots and holes in the burner.
4. Check the injector holder located at the end of the burner tube again. Remove any large particles of dust, dirt, lint, or pet hair with a soft cloth or vacuum cleaner nozzle.
5. Blow air into the primary air holes on the injector holder.
6. In case any large clumps of dust have now been pushed into the burner repeat steps 3 and 4.

Clean the pilot assembly also. A yellow tip on the pilot flame indicates dust and dirt in the pilot assembly. There is a small pilot air inlet hole about two inches from where the pilot flame comes out of the pilot assembly (see Figure 32). With the unit off, lightly blow air through the air inlet hole. You may blow through a drinking straw if compressed air is not available.

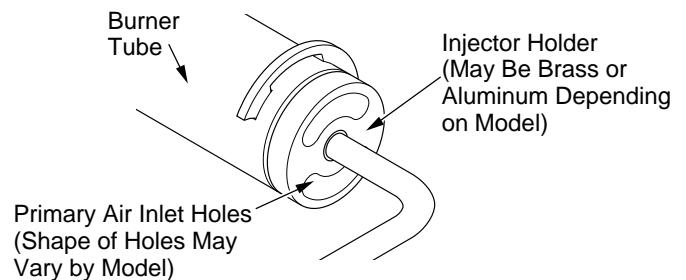

Figure 31 - Injector Holder On Outlet Burner Tube

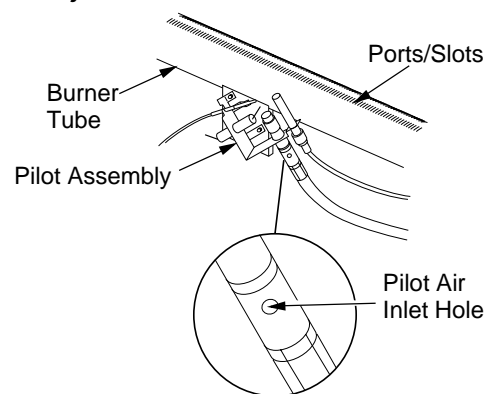

Figure 32 - Pilot Inlet Air Hole

LOGS

- If you remove logs for cleaning, refer to *Installing Logs*, page 13, to properly replace logs.
- Replace log(s) if broken or chipped (dime-sized or larger).

MAIN BURNER

Periodically inspect all burner flame holes with the heater running. All slotted burner flame holes should be open with yellow flame present. All round burner flame holes should be open with a small blue flame present. Some burner flame holes may become blocked by debris or rust, with no flame present. If so, turn off heater and let cool. Remove blockage, blocked burner flame holes will create soot.

TROUBLESHOOTING

Note: For additional help, visit DESA International's technical service web site at www.desatech.com.

Note: All troubleshooting items are listed in order of operation.

⚠ WARNING: Turn off heater and let cool before servicing. Only a qualified service person should service and repair heater.

⚠ CAUTION: Never use a wire, needle, or similar object to clean ODS/pilot. This can damage ODS/pilot unit.

OBSERVED PROBLEM	POSSIBLE CAUSE	REMEDY
When ignitor button is pressed, there is no spark at ODS/pilot	<ol style="list-style-type: none"> 1. Ignitor electrode not connected to ignitor cable 2. Ignitor cable pinched or wet 3. Piezo ignitor nut is loose 4. Broken ignitor cable 5. Bad piezo ignitor 6. Ignitor electrode broken 7. Ignitor electrode positioned wrong 	<ol style="list-style-type: none"> 1. Reconnect ignitor cable 2. Free ignitor cable if pinched by any metal or tubing. Keep ignitor cable dry 3. Tighten nut holding piezo ignitor to base panel of log set. Nut is located behind base panel. 4. Replace ignitor cable 5. Replace piezo ignitor 6. Replace pilot assembly 7. Replace pilot assembly
When ignitor button is pressed, there is spark at ODS/pilot but no ignition	<ol style="list-style-type: none"> 1. Gas supply turned off or equipment shutoff valve closed 2. Control knob not in PILOT position 3. Control knob not pressed in while in PILOT position 4. Air in gas lines when installed 5. Depleted gas supply (propane/LP gas) 6. ODS/pilot is clogged 7. Gas regulator setting is not correct 	<ol style="list-style-type: none"> 1. Turn on gas supply or open equipment shutoff valve 2. Turn control knob to PILOT position 3. Press in control knob while in PILOT position 4. Continue holding down control knob. Repeat igniting operation until air is removed 5. Contact local propane/LP gas company 6. Clean ODS/pilot (see <i>Cleaning and Maintenance</i>, page 17) or replace ODS/pilot assembly 7. Replace gas control
ODS/pilot lights but flame goes out when control knob is released	<ol style="list-style-type: none"> 1. Control knob not fully pressed in 2. Control knob not pressed in long enough 3. Equipment shutoff valve not fully open 4. Pilot flame not touching thermocouple, which allows thermocouple to cool, causing pilot flame to go out. This problem could be caused by one or both of the following: <ol style="list-style-type: none"> A) Low gas pressure B) Dirty or partially clogged ODS/pilot 5. Thermocouple connection loose at control valve 6. Thermocouple damaged 7. Control valve damaged 	<ol style="list-style-type: none"> 1. Press in control knob fully 2. After ODS/pilot lights, keep control knob pressed in 30 seconds 3. Fully open equipment shutoff valve 4. A) Contact local natural or propane/LP gas company <ol style="list-style-type: none"> B) Clean ODS/pilot (see <i>Cleaning and Maintenance</i>, page 17) or replace ODS/pilot assembly 5. Hand tighten until snug, then tighten 1/4 turn more 6. Replace pilot assembly 7. Replace control valve

TROUBLESHOOTING

Continued

OBSERVED PROBLEM	POSSIBLE CAUSE	REMEDY
Burner does not light after ODS/pilot is lit	<ol style="list-style-type: none"> 1. Burner orifice clogged 2. Inlet gas pressure is too low 3. Thermopile leads disconnected or improperly connected 4. Burners will not come on in remote position 	<ol style="list-style-type: none"> 1. Clean burner (see <i>Cleaning and Maintenance</i>, page 17) or replace burner orifice 2. Contact local natural or propane/LP gas company 3. Reconnect leads (see <i>Wiring Diagram</i>, page 21) 4. Replace battery in transmitter and receiver
Delayed ignition burner	<ol style="list-style-type: none"> 1. Manifold pressure is too low 2. Burner orifice clogged 	<ol style="list-style-type: none"> 1. Contact local natural or propane/LP gas company 2. Clean burner (see <i>Cleaning and Maintenance</i>, page 17) or replace burner orifice
Burner backfiring during combustion	<ol style="list-style-type: none"> 1. Burner orifice is clogged or damaged 2. Damaged burner 3. Gas regulator defective 	<ol style="list-style-type: none"> 1. Clean burner (see <i>Cleaning and Maintenance</i>, page 17) or replace burner orifice 2. Replace damaged burner 3. Replace gas control
Slight smoke or odor during initial operation	<ol style="list-style-type: none"> 1. Not enough air 2. Gas regulator defective 3. Residues from manufacturing processes and logs curing 	<ol style="list-style-type: none"> 1. Check burner for dirt and debris. If found, clean burner (see <i>Cleaning and Maintenance</i>, page 17) 2. Replace gas control 3. Problem will stop after a few hours of operation
Moisture/condensation noticed on windows	<ol style="list-style-type: none"> 1. Not enough combustion/ventilation air 	<ol style="list-style-type: none"> 1. Refer to <i>Air for Combustion and Ventilation</i> requirements (page 4)
Heater produces a whistling noise when burner is lit	<ol style="list-style-type: none"> 1. Turning control knob to HI position when burner is cold 2. Air in gas line 3. Air passageways on heater blocked 4. Dirty or partially clogged burner orifice 	<ol style="list-style-type: none"> 1. Turn control knob to LO position and let warm up for a minute 2. Operate burner until air is removed from line. Have gas line checked by local natural or propane/LP gas company 3. Observe minimum installation clearances (see pages 7 through 9) 4. Clean burner (see <i>Cleaning and Maintenance</i>, page 17) or replace burner orifice
White powder residue forming within burner box or on adjacent walls or furniture	<ol style="list-style-type: none"> 1. When heated, vapors from furniture polish, wax, carpet cleaners, etc. may turn into white powder residue 	<ol style="list-style-type: none"> 1. Turn heater off when using furniture polish, wax, carpet cleaners, or similar products
Remote does not function	<ol style="list-style-type: none"> 1. Battery is not installed. Battery power is low 	<ol style="list-style-type: none"> 1. Replace 9-volt batteries in receiver and remote control

TROUBLESHOOTING

Continued

- ⚠ WARNING: If you smell gas**
- **Shut off gas supply.**
 - **Do not try to light any appliance.**
 - **Do not touch any electrical switch; do not use any phone in your building.**
 - **Immediately call your gas supplier from a neighbor's phone. Follow the gas supplier's instructions.**
 - **If you cannot reach your gas supplier, call the fire department.**

IMPORTANT: Operating heater where impurities in air exist may create odors. Cleaning supplies, paint, paint remover, cigarette smoke, cements and glues, new carpet or textiles, etc., create fumes. These fumes may mix with combustion air and create odors. These odors will disappear over time.

OBSERVED PROBLEM	POSSIBLE CAUSE	REMEDY
Heater produces a clicking/ticking noise just after burner is lit or shut off	1. Metal expanding while heating or contracting while cooling	1. This is common with most heaters. If noise is excessive, contact qualified service person
Heater produces unwanted odors	1. Heater burning vapors from paint, hair spray, glues, cleaners, chemicals, new carpet, etc. (See <i>IMPORTANT</i> statement above) 2. Gas leak. See Warning statement at top of page	1. Open window and ventilate room. Stop using odor causing products while heater is running 2. Locate and correct all leaks (see <i>Checking Gas Connections</i> , page 12)
Heater shuts off in use (ODS operates)	1. Not enough fresh air is available 2. Low line pressure 3. ODS/pilot is partially clogged	1. Open window and/or door for ventilation 2. Contact local natural or propane/LP gas company 3. Clean ODS/pilot (see <i>Cleaning and Maintenance</i> , page 17)
Gas odor even when control knob is in OFF position	1. Gas leak. See Warning statement at top of page 2. Control valve defective	1. Locate and correct all leaks (see <i>Checking Gas Connections</i> , page 12) 2. Replace control valve
Gas odor during combustion	1. Foreign matter between control valve and burner 2. Gas leak. See Warning statement at top of page	1. Take apart gas tubing and remove foreign matter 2. Locate and correct all leaks (see <i>Checking Gas Connections</i> , page 12)

WIRING DIAGRAM

Note: For proper operation of optional accessories, the wires from the switch to the control must be connected exactly as shown.

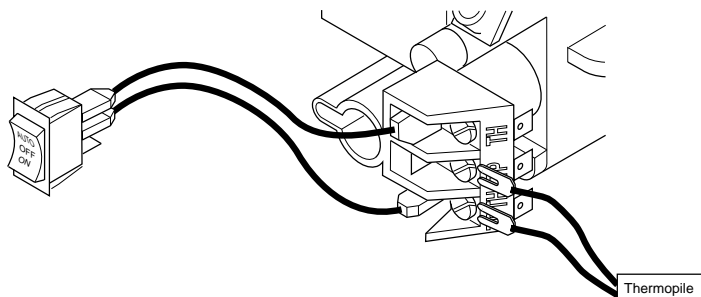

SPECIFICATIONS

	Natural Gas	Propane/LP
Btu (Variable)	20,000/39,000	20,000/39,000
Type Gas	Natural Gas Only	Propane/LP Only
Ignition	Piezo	Piezo
Pressure Manifold	3.5" W.C.	8.0" W.C.
Inlet Gas Pressure (in. of water)		
Maximum	10.5"	14"
Minimum*	5"	11"
Shipping Weight	32 lbs.	32 lbs.

* For input adjustment

SERVICE HINTS

When Gas Pressure Is Too Low

- pilot will not stay lit
- burners will have delayed ignition
- heater will not produce specified heat
- propane/LP gas supply may be low

You may feel your gas pressure is too low. If so, contact your local natural or propane/LP gas supplier.

TECHNICAL SERVICE

You may have further questions about installation, operation, or troubleshooting. If so, contact DESA International's Technical Service Department at 1-866-672-6040. When calling please have your model and serial numbers of your heater ready.

You can also visit DESA International's technical services web site at www.desatech.com.

REPLACEMENT PARTS

Note: Use only original replacement parts. This will protect your warranty coverage for parts replaced under warranty.

PARTS UNDER WARRANTY

Contact authorized dealers of this product. If they can't supply original replacement part(s), call DESA International's Technical Service Department at 1-866-672-6040. When calling DESA International, have ready

- your name and address
- model and serial numbers of your heater
- how heater was malfunctioning
- type of gas used (propane/LP or natural gas)
- purchase date

Usually, we will ask you to return the part to the factory.

PARTS NOT UNDER WARRANTY

Contact authorized dealers of this product. If they can't supply original replacement part(s), call DESA International at 1-866-672-6040 for referral information. When calling DESA International, have ready

- model number of your heater
- the replacement part number

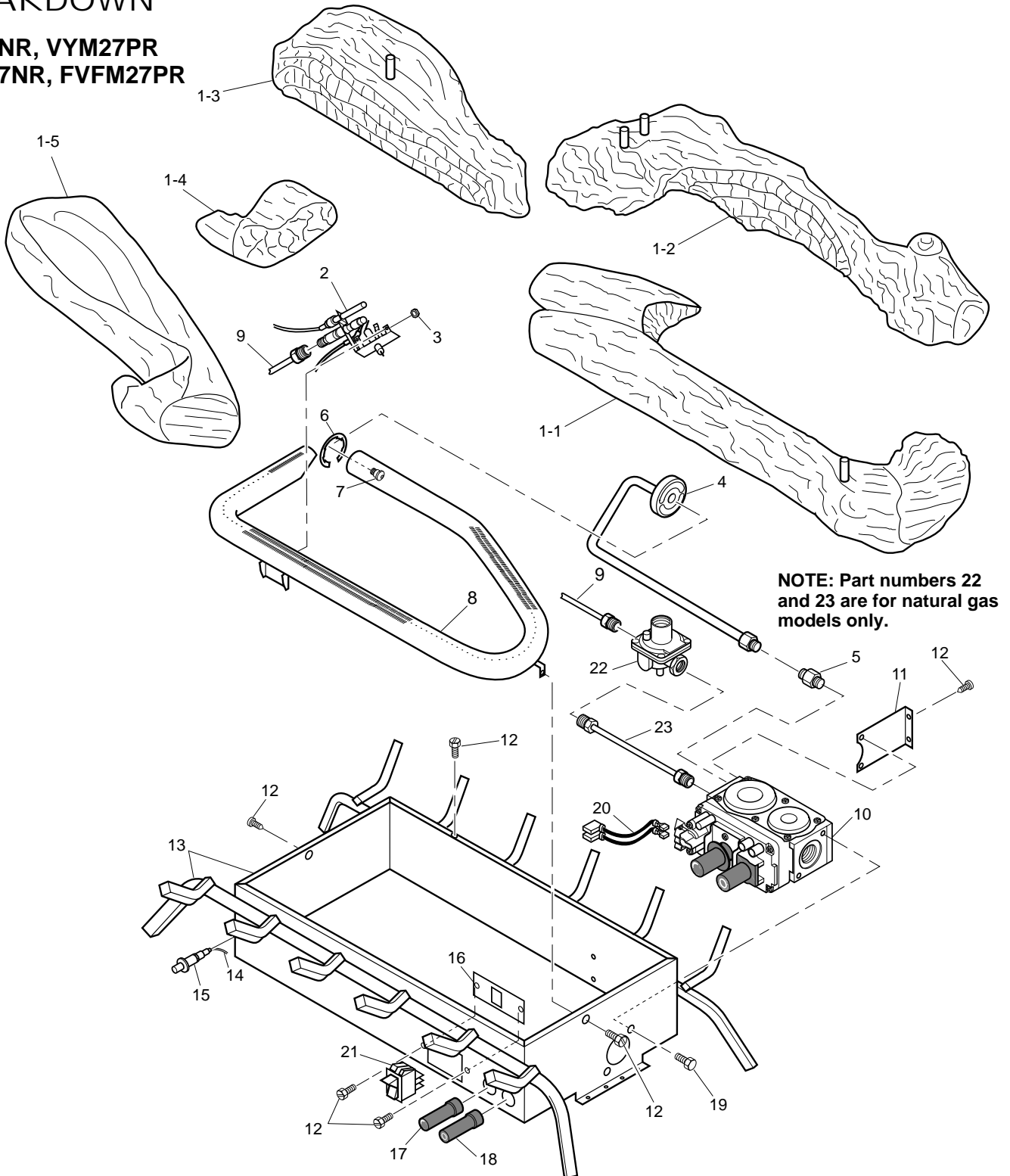
ILLUSTRATED
PARTS
BREAKDOWNVYM27NR, VYM27PR
FVFM27NR, FVFM27PRFor more information, visit www.desatech.com

PARTS LIST

This list contains replaceable parts used in your heater. When ordering parts, follow the instructions listed under *Replacement Parts* on page 21 of this manual.

VYM27NR
VYM27PR
FVFM27NR
FVFM27PR

KEY NO.	PART NUMBER		DESCRIPTION	QTY.
	VYM27NR FVFM27NR	VYM27PR FVFM27PR		
1a	104676-01	104676-01	1 Piece Log Set	
1b	110397-06	110397-06	5 Piece Log Set	1
1-1	110321-01	110321-01	Front Log (#1)	1
1-2	110321-02	110321-02	Rear Log (#2)	1
1-3	110321-05	110321-05	Center Insert Log (#3)	1
1-4	110321-03	110321-03	Top Left Log (#4)	1
1-5	110321-04	110321-04	Top Right Log (#5)	1
2	103779-01	103778-01	ODS Pilot	1
3	098249-01	098249-01	ODS Nut	2
4	104592-01	104592-02	Burner Outlet Tube	1
5	098264-02	098264-02	Male Connector	1
6	102843-01	102843-01	Burner Clip	1
7	099056-16	099056-17	Burner Orifice Injector	1
8	104591-01	104591-01	Burner	1
9	100609-01	099387-13	Pilot Tube (Regulator to Pilot)	1
10	103781-01	103781-02	Gas Control Valve	1
11	104611-01	104611-01	Lower Bracket	1
12	098304-01	098304-01	Screw, #8 x .38	7
13	104590-01CK	104590-01CK	Painted Base Assy	1
14	098271-06	098271-06	Ignitor Cable	1
15	102445-01	102445-01	Piezo Ignitor	1
16	103587-02CK	103587-02CK	Plate, Switch	1
17	103784-02	103784-02	Flame Adjustment Knob	1
18	103784-01	103784-01	Off-Pilot-On Knob	1
19	M12461-26	M12461-26	Screw, Hex Slit Wsr 10-32 x .38	4
20	103284-02	103284-02	Wiring Harness	1
21	099998-01	099998-01	Switch	1
22	099918-02	—	Pilot Regulator	1
23	099387-15	—	Pilot Tube (Valve to Regulator)	1
PARTS AVAILABLE — NOT SHOWN				
	100563-01	100563-01	Warning Plate	1
	103877-01	103877-01	Lighting Instructions Plate	1
	100565-01	100565-01	Warning Plate Fastener	1
	100639-01	100693-01	Caution Decal	1
	101137-02	101137-02	Hardware Kit	1
	GA6060	GA6060	Lava Rock	2

ACCESSORIES

Purchase these heater accessories from your local dealer. If they can not supply these accessories, call DESA International at 1-866-672-6040 for referral information. You can also write to the address listed on the back page of this manual.

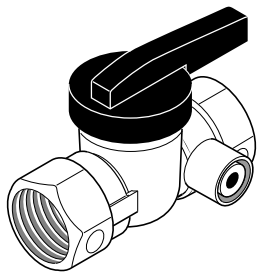

EQUIPMENT SHUTOFF VALVE - GA5010

For all models. Equipment shutoff valve with 1/8" NPT tap. Fits 1/2" NPT pipe.

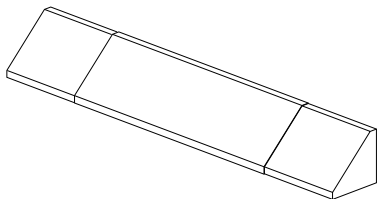

FIREPLACE HOOD

Black - GA6050

Brass - GA6052

Antique Brass - GA6053

For all models. Helps deflect heat away from mantel or wall above fireplace. Fits openings 28" to 48" wide.

LAVA ROCK - GA6060

(Not Shown)

For all models. Order when additional rock is desired. (3 lb. bag)

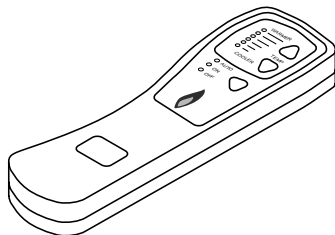

RECEIVER AND HAND-HELD THERMOSTAT REMOTE CONTROL KIT - GHRCTA SERIES

For all models. Allows the gas log heater to be operated in a manually or thermostatically-controlled mode. You can turn the gas log heater on and off without ever leaving the comfort of your easy chair.

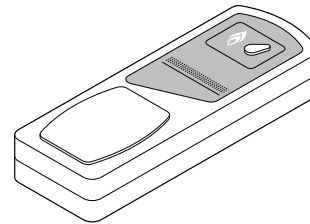

RECEIVER AND HAND-HELD REMOTE CONTROL KIT - GHRC

For all models. Allows the gas log heater to be turned on and off by using a hand-held remote control.

WALL-MOUNT THERMOSTAT SWITCH - GWMT1

(Not Shown)

For all models. The desired comfort setting can be selected on the wall thermostat and the log heater will automatically cycle from pilot to the heat setting selected.

WALL-MOUNT ON/OFF SWITCH - GWMS2

(Not Shown)

For all models. Allows the gas log heater to be turned on and off with a wall switch.

DAMPER CLAMP - GA6080

(Not Shown)

Permanently opens chimney flue damper for vented operation. Can be used only with non-thermostat accessories.

CLEANING KIT - GCK

(Not Shown)

For all models. Your vent-free gas appliance requires regular cleaning and maintenance to prevent performance problems. This kit gives you the tools and instructions to make it easy to clean all critical areas of your appliance.

INFORMATION VIDEO - 108917-01

For all models. A care and maintenance video is available by calling 1-866-672-6040.

OWNER'S REGISTRATION FORM

In order to provide better customer service for this and future purchases, we recommend that you register your product with us. You can register online at www.desatech.com. If access to our website is not available to you, please complete this Owner's Registration Form and mail to the address on the back of this owner's manual. Please provide the following product information:

Brand: _____ (Comfort Glow, Vanguard, etc.)
 Model: _____ (EFP33PR, VTGH33NR, etc.)
 Date Purchased: _____ *Note: Keep receipt for warranty verification.*
 Serial Number: _____ 7 or 9 digit number located on product or identification tag.
 First Name: _____ Last Name: _____
 Address: _____
 City: _____ State: _____ Zip: _____ Country: _____
 Home Phone: _____ - _____
 E-Mail: _____

Please answer the following questions to register your product with DESA International:

1. Where will the product be used?
 Living/Family Room Office/Warehouse Utility Shed/Outbuilding Garage Bedroom Bathroom Other
2. If you bought this product yourself, did you plan to purchase this type of product before going into the store? Yes No
3. Who selected the product? Male Female Both
4. What is the population of your area? Under 10,000 10,000 to 25,000 25,000 to 50,000 50,000 to 100,000
 100,000 to 250,000 Over 250,000
5. What is your primary source of heat? Propane (LP Gas) Fuel Oil Wood Natural Gas Electric Other
6. How was the product installed? Professional Installer Self Other
7. Cost of product excluding sales tax? \$ _____
8. Cost to install product? \$ _____
9. Type of store where product was purchased? Hardware Propane Dealer Natural Gas/Utility Co. Home Center/Builder's Supply
 Fireplace or Hearth Shop Farm Store Other
10. What motivated you to buy this product? Sudden Cold Weather Replace Older Model D.I.Y. Home Project
 Emergency Back-Up Heat Heater was on Sale Energy Savings/High Efficiency Construction Project Other
11. How did you learn about this product brand? Advertising Relative or Friend Store Display Other _____
12. Level of Education of Purchaser: Some High School Completed High School Completed College Completed Graduate School
13. Age of Purchaser: Under 20 20 - 29 30 - 39 40 - 49 50 - 59 60 or Over
14. Buyer's total annual household income: Under \$15,000 \$15,000 to \$19,999 \$20,000 to \$34,999 \$35,000 to \$49,999
 \$50,000 to \$74,999 \$75,000 to \$99,999 \$100,000 and Over
15. Store where product was purchased:
 Name: _____
 City: _____ State: _____

16. In choosing this product, how important were the following:

	Not Important	Somewhat Important	Very Important
Availability	<input type="radio"/>	<input type="radio"/>	<input type="radio"/>
Price	<input type="radio"/>	<input type="radio"/>	<input type="radio"/>
Brand Name	<input type="radio"/>	<input type="radio"/>	<input type="radio"/>
Overall Quality	<input type="radio"/>	<input type="radio"/>	<input type="radio"/>
Heat Output	<input type="radio"/>	<input type="radio"/>	<input type="radio"/>
Made in USA	<input type="radio"/>	<input type="radio"/>	<input type="radio"/>
Warranty	<input type="radio"/>	<input type="radio"/>	<input type="radio"/>
Local Service	<input type="radio"/>	<input type="radio"/>	<input type="radio"/>
Value for Price	<input type="radio"/>	<input type="radio"/>	<input type="radio"/>
Prior Brand Experience	<input type="radio"/>	<input type="radio"/>	<input type="radio"/>
Controls Location	<input type="radio"/>	<input type="radio"/>	<input type="radio"/>
Thermostat, Remote, or Manual Operation	<input type="radio"/>	<input type="radio"/>	<input type="radio"/>
Ease of Operation	<input type="radio"/>	<input type="radio"/>	<input type="radio"/>
Special Features	<input type="radio"/>	<input type="radio"/>	<input type="radio"/>
Salesperson's Recommendation	<input type="radio"/>	<input type="radio"/>	<input type="radio"/>
Friend/Relative's Recommendation	<input type="radio"/>	<input type="radio"/>	<input type="radio"/>
Portability	<input type="radio"/>	<input type="radio"/>	<input type="radio"/>
Quiet Operation	<input type="radio"/>	<input type="radio"/>	<input type="radio"/>

TAPE

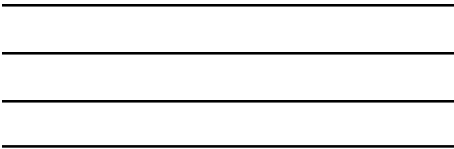

Postage
Required

DESATM
INTERNATIONAL
2701 Industrial Drive
P.O. Box 90004
Bowling Green, KY 42102-9004

TAPE

WARRANTY INFORMATION

KEEP THIS WARRANTY

Model _____
Serial No. _____
Date Purchased _____

Always specify model and serial numbers when communicating with the factory.

We reserve the right to amend these specifications at any time without notice. The only warranty applicable is our standard written warranty. We make no other warranty, expressed or implied.

LIMITED WARRANTY VENT-FREE GAS LOG HEATERS

DESA International warrants this product to be free from defects in materials and components for four (4) years from the date of first purchase, provided that the product has been properly installed, operated and maintained in accordance with all applicable instructions. To make a claim under this warranty the Bill of Sale or cancelled check must be presented.

This warranty is extended only to the original retail purchaser. This warranty covers the cost of part(s) required to restore this heater to proper operating condition and an allowance for labor when provided by a DESA Authorized Service Center. Warranty part(s) MUST be obtained through authorized dealers of this product and/or DESA International who will provide original factory replacement parts. Failure to use original factory replacement parts voids this warranty. The heater MUST be installed by a qualified installer in accordance with all local codes and instructions furnished with the unit.

This warranty does not apply to parts that are not in original condition because of normal wear and tear, or parts that fail or become damaged as a result of misuse, accidents, lack of proper maintenance or defects caused by improper installation. Travel, diagnostic cost, labor, transportation and any and all such other costs related to repairing a defective heater will be the responsibility of the owner.

TO THE FULL EXTENT ALLOWED BY THE LAW OF THE JURISDICTION THAT GOVERNS THE SALE OF THE PRODUCT; THIS EXPRESS WARRANTY EXCLUDES ANY AND ALL OTHER EXPRESSED WARRANTIES AND LIMITS THE DURATION OF ANY AND ALL IMPLIED WARRANTIES, INCLUDING WARRANTIES OF MERCHANTABILITY AND FITNESS FOR A PARTICULAR PURPOSE TO FOUR (4) YEARS ON ALL COMPONENTS FROM THE DATE OF FIRST PURCHASE; AND DESA INTERNATIONAL'S LIABILITY IS HEREBY LIMITED TO THE PURCHASE PRICE OF THE PRODUCT AND DESA INTERNATIONAL SHALL NOT BE LIABLE FOR ANY OTHER DAMAGES WHATSOEVER INCLUDING INDIRECT, INCIDENTAL OR CONSEQUENTIAL DAMAGES.

Some states do not allow a limitation on how long an implied warranty lasts or an exclusion or limitation of incidental or consequential damages, so the above limitation on implied warranties, or exclusion or limitation on damages may not apply to you.

This warranty gives you specific legal rights, and you may also have other rights that vary from state to state.

For information about this warranty write:



2701 Industrial Drive
P.O. Box 90004
Bowling Green, KY 42102-9004
www.desatech.com

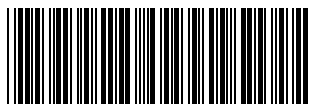

110398 01

NOT A UPC

110398-01
Rev. A
06/02

For more information, visit www.desatech.com

Free Manuals Download Website

<http://myh66.com>

<http://usermanuals.us>

<http://www.somanuals.com>

<http://www.4manuals.cc>

<http://www.manual-lib.com>

<http://www.404manual.com>

<http://www.luxmanual.com>

<http://aubethermostatmanual.com>

Golf course search by state

<http://golfingnear.com>

Email search by domain

<http://emailbydomain.com>

Auto manuals search

<http://auto.somanuals.com>

TV manuals search

<http://tv.somanuals.com>