

DIRECTV and RCA are dedicated to providing you with quality support and customer service. If you have questions or difficulties, we would like to hear from you.

For questions regarding your DIRECTV® DVR, DIRECTV® programming or your DIRECTV® DVR with TiVo® service, after checking the Troubleshooting chapter of this guide, please contact DIRECTV at 1-800-531-5000.

If your DVR is not working properly even after restarting it, you are having trouble with the remote control, or you have other technical questions, please contact RCA at 580-634-0151.

When you call either RCA or DIRECTV, you will need to provide the 12 digit number on your DVR's access card, and the make, model number, serial number and 12 digit Receiver ID number of your DVR, located on a label on the back of the DVR and on the System Information screen under Messages & Setup.

DIRECTV® DVR User's Guide



DIRECTV® DVR User's Guide

WEB SITES

You will find all of the most up-to-date information about DIRECTV products and services at the DIRECTV web site, DIRECTV.com. The RCA web site at RCA.com has links to a wide variety of products and information.

16283360



The On-Screen Menus and the Remote Control

Arrow Buttons



To use the DIRECTV® DVR's on-screen menus: Use the remote control's arrow buttons to move the highlight bar onto the option you want, then press SELECT.

The LEFT arrow button often takes you to a previous screen.

Select



Two Types of On-Screen Arrows

The arrows that appear beside or near the highlight bar show possible directions. For example: on this screen, you could press the RIGHT arrow to highlight Options or the DOWN arrow to highlight Edit Keyword WishList.

Page Up Arrow

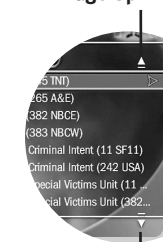

Page Down Arrow

When you see page up or page down arrows at the top or bottom of the screen (or a list), press the CHAN UP/DOWN button to jump to more items an entire page at a time.



Chan Up/Down Button

Highlight Bar



Arrows Near Highlight Bar

Hints & Shortcuts

Press the **DIRECTV** button once to go to DIRECTV Central, or twice to go to the Now Playing List.

LIST brings you directly to the Now Playing List.

Press **FWD** (fast forward) and **BACK** (rewind) up to 3 times for 3 speeds. Press them a fourth time to resume normal play.

INSTANT REPLAY replays the last 8 seconds of a program.

Press **CLEAR** to delete a title in a list (like the Now Playing list) or to clear things that aren't part of the program you're watching (like the channel banner and status bar).

INFO brings up the channel banner. Press the RIGHT arrow to switch among three versions of the banner, each with a different amount of information.

CHAN UP/DOWN does more than change the channel—it also pages up or down through lists of programs or menu items.

Inserting Batteries in the Remote Control

Hold the remote with the battery door facing you. Place your thumb in the depression of the door and slide the door towards you.

Insert two AA batteries (supplied). Be sure to match the + and - marks on the batteries to the + and - marks in the compartment.

Replace the battery door by sliding it back into the case with the tabs towards the rear of the compartment. You'll hear a click when it's securely back in place.

Press **GUIDE** to see the DIRECTV Advanced Program Guide™, then press **INFO** (while the guide is visible) to see Guide Options and change the day or time, or show only a category of programs.

EXIT clears all menus and goes to the last channel or recorded program you were watching. If you press it while you are watching a program, it clears things that aren't part of the program (like the channel banner and status bar).

ADVANCE moves you quickly through saved programming. Press it while you are fast forwarding or rewinding to jump to the next tick mark on the status bar.

When you're watching "behind" live TV (for example, if you paused live TV and later resumed watching from the paused spot), **ADVANCE** catches you up to the live broadcast. In a recorded program, press it once to jump to the end of the program, then again to jump to the beginning.

If you program your remote control (as explained in chapter seven), the **TV POWER**, **VOLUME**, **MUTE**, and **TV INPUT** buttons can control your TV and A/V equipment.

The **SAT/TV Switch** sets the remote control to send channel changing signals to either the DVR (**SAT**) or the television (**TV**). Many of the remote control's buttons are disabled when this switch is set to **TV** (for example, **SLOW**, **FAST FORWARD** and **PAUSE**), so if your remote control doesn't seem to be working, check to make sure this switch is set to **SAT**.

The **WINDOW** button is for future use.

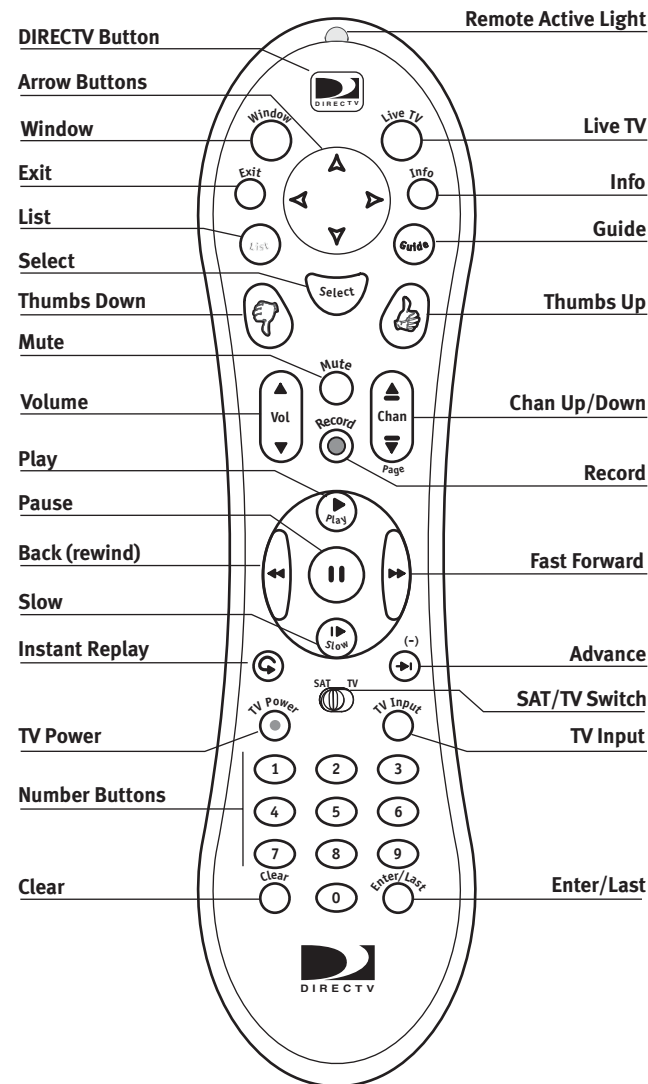

Glossary of Icons



These appear when you press the THUMBS UP or THUMBS DOWN button. You can give a program up to three Thumbs Up™ or three Thumbs Down™.



These appear when an option—such as automatically scheduling an upcoming program or watching an additional program segment—is available. Press SELECT or THUMBS UP to choose the option.



Now Playing



(Green) This program will be saved until you delete it.



(Yellow) In less than one day, this program may be deleted to make room for other programs you have requested, but only if space is needed.



(Yellow with exclamation mark) At any time, this program may be deleted to make room for other programs you have requested, but only if space is needed.



(Red with black border) This program is currently being recorded.



This program is a TiVo® Suggestion. TiVo Suggestions are recorded on empty space and are the first programs to be deleted.

To Do List and View Upcoming Episodes



Program is an individual recording (not part of a Season Pass™ or WishList™). In other places, it means an item has been selected.



Program will be recorded as part of a Season Pass.



Program will be recorded as part of a WishList.

DIRECTV Central and Showcases



Appears on DIRECTV Central beside an option that changes. Select it to record a program, watch a preview, or visit a Showcase.



Indicates a selection in DIRECTV Central or Showcases that has some special video content.

Channel Banner



Select to start or stop a recording.



Select to display or turn on Parental Controls.



Select to view Messages.



Select to choose an alternate audio track, if an alternate audio track is available.



Select to turn Dolby Digital audio on or off, if Dolby Digital audio is available.



Highlight to see what's on the other tuner. This icon becomes bright if the other tuner is recording a program.

DIRECTV Advanced Program Guide™



This appears beside pay per view events that are All Day Tickets.



This appears beside programs that are broadcast with Dolby Digital audio.



This icon appears beside programs that are broadcast in Letterbox format.

Welcome to DIRECTV[®]

16283360

RCA is a trademark of RCA Trademark Management S.A.
Thomson, 10330 North Meridian Street, Indianapolis, IN U.S.A. 46290

DIRECTV and the Cyclone Design logo, DIRECTV SPORTS THIS WEEK, and
Advanced Program Guide are trademarks of DIRECTV, Inc., a unit of Hughes Electronics Corp., and are used
with permission. All rights reserved. DIRECTV,
2230 East Imperial Hwy., El Segundo, CA 90245.

TiVo and the TiVo logo are registered trademarks of TiVo Inc. The Instant Replay logo,
the Jump logo, TiVolution Magazine, Season Pass, WishList, Overtime Scheduler,
the Thumbs Down logo and text, the Thumbs Up logo and text, TiVo and Line Design (smile)
are trademarks of TiVo Inc. 1999, 2000. All rights reserved.

TiVo Inc., 2160 Gold Street, P.O. Box 2160, Alviso, CA 95002-2160.

Manufactured under license from Dolby Laboratories.

“Dolby” and the double-D symbol are trademarks of Dolby Laboratories.

All other trademarks are the properties of their respective owners.

© 1999, 2002 by TiVo Inc. Reproduction in whole or in part without
written permission is prohibited.

Product Registration

Please fill out the product registration card (packed separately) and return it immediately, or register online at
rca.com. Returning the card allows us to contact you if needed.

Product Information

Keep your sales receipt to obtain warranty parts and service and for proof of purchase. Attach it here and record
the serial and model numbers in case you need them. These numbers are located on the product.

Model No. _____

Serial No. _____

Purchase Date: _____

Dealer/Address/Phone: _____

Welcome to the DIRECTV family!

DIRECTV offers you more Hollywood hits, classic movies, family programming, news, and a wide range of exciting sports action. Plus access to 36 commercial-free audio channels. And that's only the beginning.

More Choices than ever before.

With access to over 225 channels, it's easy to see why DIRECTV has become the entertainment choice for millions of American families. And it's all digitally delivered, so you get digital-quality sound and razor-sharp picture every time you turn on your TV!

DIRECTV[®] Pay Per View movies and events.

With DIRECTV service, the main event is at your house! You'll have access to great movies, exclusive special live sports, concerts and special events. DIRECTV offers up to 55 different pay per view choices a day. There's no need to order by phone. Just use your remote control to give all your friends and family a front-row seat! (Phone connection required.)

DIRECTV knows sports.

DIRECTV offers access to more sports than you ever thought possible. So you can follow your favorite team across the country with our pro & college sports subscriptions. DIRECTV will take you to the arena for the best sports has to offer. Tune to Channel 212 for DIRECTV SPORTS THIS WEEK[®].

With DIRECTV you're in control.

Your new DIRECTV[®] DVR brings you the hottest new entertainment technology, including the DIRECTV Advanced Program Guide[™], with up to 14 days of program listings, and the ability to pause and replay live TV. Plus, with Pick Programs to Record and the other incredibly powerful and easy to use features of your DIRECTV DVR service, you will have a Season Pass[™] to all your favorite programming.



▶▶ Table of Contents

Using this Guide	vii
Chapter 1: Connecting	1
Overview	2
Before You Begin	3
Useful Terms	5
Cables and Accessories	9
Setup Examples	10
Chapter 2: Guided Setup	23
Overview	24
Satellite Dish Guided Setup	25
Activate	29
Phone Setup	30
Chapter 3: The Basics in 5 Short Tours	33
Tour 1: Play with Live TV	34
Tour 2: DIRECTV Advanced Program Guide™	36
Tour 3: Find and Record Your Favorite Programs	38
Tour 4: Search for New Programs	40
Tour 5: Now Playing List	42
Cool Things You Can Do	43
Chapter 4: Watching Live TV	45
Let's Go!	46
DIRECTV Advanced Program Guide™	48

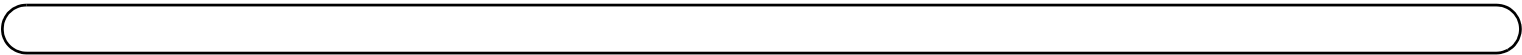

Channel Banner	51
Play with Live TV	52
Status Bar	53
Music Channels	54
Standby	55

Chapter 5: Finding and Recording Programs57

Recording Programs: The Basics	58
Finding Programs to Record	68
I Already Know What I Want to Record	69
I Know What I Like	73
Help Me Find New Programs	79

Chapter 6: Messages and Setup83

Messages from DIRECTV	84
Purchases	85
My Preferences	89
Recorder & Phone Setup	99
System Information	106
Troubleshooting	107
Restart or Reset System	108

Chapter 7: Programming the Remote Control109

Introduction	110
Instructions: TV Power, Volume, and TV Input	111
Resetting the Programmable Buttons	114
Setting a Remote Address	115

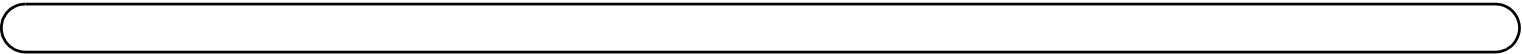

- Chapter 8: Troubleshooting117**
 - Contacting Customer Care 118
 - Questions About Installation 119
 - Questions About Live TV (Including Satellite Signal) 120
 - Questions About Pick Programs to Record 125
 - Questions About Parental Controls 131
 - Questions About the DVR’s Phone Calls 132
 - Questions About Audio 135
 - Questions About Pay Per View 136
 - Questions About the Remote Control 138
 - Questions About the DVR Service 139

- Chapter 9: Warranty and Specifications141**
 - Limited Warranty 142
 - FCC Information 144
 - Specifications 146
 - Safety Instructions 148

- Appendix A: Back Panel Reference151**

- Appendix B: GNU General Public License155**

- Index161**

►► Using this Guide

This *User's Guide* describes how to connect your new DIRECTV® DVR to your television and other audio/video equipment. It also provides valuable information about the features and use of the DVR.

Glossary of Icons. The inside front cover of this guide provides an introduction to the remote control. The inside back cover has a “Glossary of Icons” that explains many of the graphic symbols you will see when using your DVR.

Useful Terms. Many of the technical terms you may encounter in this guide are explained in the “Useful Terms” section beginning on page 5.

Screen Paths. Notes at the bottom of some pages show you how to find the screen being discussed on that page. For example, page 70 describes the “Record by Time or Channel” feature. At the bottom of the page is the note “**DIRECTV Central ► Pick Programs to Record ► Record by Time/Channel**” This note means you can find Record by Time/Channel, the screen being discussed, by going to DIRECTV Central (press the DIRECTV button on your remote control) and selecting Pick Programs to Record, then Record by Time/Channel.

DIRECTV® DVR with TiVo® Service. The recording service provided through the DIRECTV® DVR.

DIRECTV DVR. Refers collectively to the satellite antenna receiver and the DVR hardware.



Throughout this guide, you will see important and helpful notes and tips in this format.



The TiVo Logo. As you use your DIRECTV DVR, you'll see the TiVo logo in places like the Now Playing List and TiVo Suggestions. Your new DVR incorporates the latest DVR (Digital Video Recorder) technology from TiVo. This means you have access to exclusive TiVo features such as WishList™ searches, Season Pass™ recordings, Thumbs Up™ and Thumbs Down™, TiVo Suggestions, and TiVolution Magazine®, all in one seamlessly integrated product that will change the way *you* watch television.



Before you install the DVR, mount the satellite dish antenna.

Professional installation is highly recommended. Your dish must be mounted, with cables running to the room where your DVR will be installed, before you can begin the DVR installation as described in this guide. Dual LNB dish antenna connection required for full functionality.

▶ **Getting Started**

After a satellite dish antenna has been installed, you're ready to start using this guide:

1. Connect the DVR according to the proper setup for your Audio/Video equipment. (See chapter 1, "Connecting.")
2. Complete Guided Setup to point your satellite dish antenna and activate the DIRECTV® DVR with TiVo® service following the instructions in chapter 2, "Guided Setup."

Start using your DIRECTV DVR. It's easy! Learn the basics by browsing the back of the *Start Here* card. Take the five tours in chapter 3 of this *User's Guide* for an interactive way to learn about the DVR's powerful features. Chapters 4, 5, 6, and 7 describe the DVR service in detail. Read through them to become familiar with the service. Chapter 8 provides a comprehensive troubleshooting guide in case you have questions.

Connecting

Overview	2
Before You Begin	3
Useful Terms	5
Cables and Accessories	9
Setup Examples	10



Jacks are places where cables can be connected.



Always connect cables from the OUT jack of one device to the IN jack of the next. Never connect an IN to an IN or an OUT to an OUT.

Overview

TV used to be simple: no color, no digital video, no stereo sound, no digital audio, no choices. All you needed was an antenna and a TV. The antenna captured pictures and sounds. A wire connected the antenna to the TV to transfer pictures and sounds.

As televisions have acquired more features, and new devices have been created to work with them, it may seem that everything has become more complex. Fortunately, the fundamentals haven't changed. You may have a VCR, a DVD player and a game system, in addition to a satellite dish antenna. However, one thing has remained the same: what you need to do is get the pictures and sounds from their source (the satellite dish antenna) to your TV.

You use cables to make a path over which the pictures and sounds travel from your satellite dish antenna to your TV.

On the back of your equipment you will find several jacks. Some are labeled IN and some are labeled OUT. The pictures and sound enter a piece of equipment through a cable connected to an IN jack and leave through a cable connected to an OUT jack.

When you connect your DIRECTV® DVR to your television and other audio/video equipment, you are simply creating a path that starts at the satellite dish antenna and goes in (through IN jacks) and out (through OUT jacks) of your equipment until it reaches your TV.

▶▶ Before You Begin

Make sure that all of your equipment is turned off and the DIRECTV DVR is unplugged.

▶ Connecting to a Phone Line

You will need access to a standard analog phone jack. Your DVR needs to be connected to a phone line to communicate with DIRECTV. The DVR occasionally makes a brief phone call to get updates to the DVR service and Showcases, and for pay per view functionality.

You do not need to install a new telephone jack or phone number for the DVR to work; it can detect when your phone line is in use and will only make calls when the phone line is available. If you don't have a phone jack nearby, you can use the 25 foot phone cord that ships with the DVR. If your phone jack is being used for a phone, you can use the provided splitter to connect both the phone and the DVR to the same phone jack.

▶ Connecting a Dual LNB or a Multi-Satellite Dish Antenna

Your DVR comes equipped with two jacks for satellite input. While the DVR will work if connected to only one satellite input, connecting both allows you to record from two channels at the same time. All of the connection examples in this chapter give instructions for configuring the DVR with connections to both satellite input jacks.

Both a Round Dual LNB dish antenna and an Oval 2 or 3 satellite dish antenna connect to at least two coaxial RF cables. To connect both of your DVR's satellite input jacks, you must have two coaxial RF cables coming from your satellite dish antenna to the room where the DVR will be installed.



Your DVR should not be used with a digital PBX phone system. Doing so may permanently damage your DVR's modem and will void your warranty. Digital PBX phone systems allow many phones to share a single telephone number and are usually used in hotels and office buildings. If you are installing the DVR in your home, it is very unlikely that you are using a digital PBX phone system.



If you have a Single LNB satellite dish antenna, you will need to upgrade to a Dual LNB for full functionality. Contact your satellite dish antenna manufacturer for more information about upgrading.



Your DIRECTV DVR is multi-satellite capable if used with a DIRECTV Multi-Satellite Dish Antenna, (not included with all systems).



For information on how to switch between watching antenna or cable channels and watching DIRECTV channels, see the connection example in Chapter 2 that is most appropriate to your configuration.



The DVR does not have an on/off switch. To turn the DVR on, plug it in. The DVR, like a clock or a refrigerator, is designed for constant use and does not need to be turned off. If you must turn it off—for example, to move it—simply unplug it. (The DVR does have an optional standby mode, explained on page 55.)



Be sure to read the safety instructions on page 148.

If you currently own a Dual LNB satellite dish antenna that is already connected to two TVs, you can purchase a multiswitch (described on page 6) that will allow you to connect two cables to your new DVR as well as one to an existing receiver for your second TV.

► **Using an Antenna or Cable Connection, in Addition to DIRECTV® Programming**

If you have an antenna or cable connection in addition to your satellite dish antenna, you can watch antenna or cable channels while recording DIRECTV® channels. However, recording and other features (such as parental controls, purchasing pay per view programs, viewing on-screen menus, or pausing live TV), do not work on cable or antenna channels.

► **Caring for your DIRECTV DVR**

Do not drop. Your new DVR contains a hard disk drive that is constantly in motion; it may be damaged if the DVR falls or is dropped. Place the DVR in a stable location.

Unplug before moving. To prevent damage to sensitive components such as the hard disk drive, always unplug your DVR and then wait a moment for the hard disk to stop spinning before moving it.

Do not stack. Your DVR is NOT designed to carry the weight of other consumer components such as VCRs, DVD players, or A/V receivers.

Flat, hard surface. The DVR should rest on a flat, hard surface only. Do not operate it on a carpet or other padded surface, as this can inhibit proper ventilation and cause the unit to overheat.

Use a surge protector. Like all electronics equipment, your DVR can be damaged by fluctuations in your power supply. Purchasing a surge protector is highly recommended. If you purchase a surge protector that allows you to plug in both your DVR's power and your telephone cord, you may prevent damage to the parts of your DVR that are connected to your phone line as well!

▶▶ Useful Terms

If you're not an audio/video wizard, you may find yourself stumbling over some of the names, features and functions of various pieces of equipment. Here's a quick reference to help you understand some of the terms you may encounter during installation.

▶ **Satellite Dish Antennas—Types and Terms**

Round Single Satellite Dish Antenna, Oval 2 Satellite Dish Antenna, and Oval 3 Satellite Dish Antenna:

The names Round single, Oval 2, and Oval 3 satellite dish antennas refer to both the most common shape of the dish and the number of satellites from which a dish can receive information. To determine what type of dish you have, look at the arm extending out from the dish. At the end of this arm is one or more “fingers” ending in mushroom shaped parts pointing back at the dish. A single satellite dish antenna has one of these “fingers” pointing back at the dish, a 2 satellite dish antenna has two, and a 3 satellite dish antenna has three. If you own a 2 or 3 satellite dish antenna, your DVR will not work properly unless you have connected a multiswitch with at least four inputs and two outputs. For a definition of a multiswitch, see page 6.

Single LNB and Dual LNB Satellite Dish Antennas: Single LNB and Dual LNB refer to the number of independent signals a dish can send to your audio/video equipment. A Single LNB sends one signal and has one jack, or connector, inside the arm extending from the dish. A Dual LNB sends two signals and has two jacks. The easiest way to determine what type of dish you have is to consult the documentation that came with the dish. Disassembling the dish to determine its type is not recommended.

Satellite Receiver: A satellite receiver does what its name suggests and more. It “receives” the signal from your satellite dish antenna, then translates it into a signal your TV can understand, then sends it to the TV. Your DIRECTV® DVR has a built-in satellite receiver.

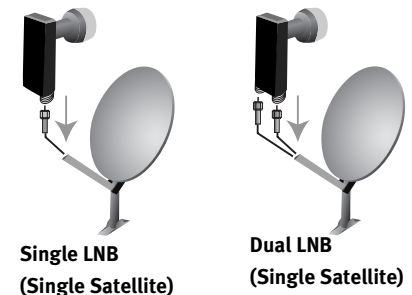
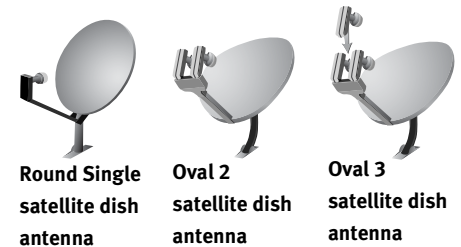

Dual Tuner: A tuner picks one channel out of all of your available channels. This allows you to view a single channel and to change channels. “Dual tuner” means your DIRECTV DVR has two tuners. It can pick out two channels at once, allowing you to record programs on two channels at the same time.



Multiswitch: A multiswitch lets you use the signal from one satellite dish antenna for more than two TVs. If you currently own a Dual LNB dish that is connected to two televisions, a multiswitch will allow you to connect two cables to your new DVR as well as one to a satellite receiver on your second television. If you own a 2 or 3 satellite dish antenna, your DVR will not work unless you have connected a multiswitch with at least four inputs and two outputs.



Access Card: Your access card contains information about your DIRECTV programming subscription. It must be properly inserted and activated for your DVR to work.

Transponder: A transponder is a piece of radio equipment on a satellite. The DIRECTV transponders receive information from DIRECTV and rebroadcast it to your satellite dish antenna. Each transponder rebroadcasts a different set of channels. If the DVR does not receive a signal for an individual transponder, it will not be able to show that transponder’s channels. Each satellite may have a different number of transponders on it.

► **Cables and Connections**



Composite Video and Left/Right (L/R) Audio Cables: Composite Video and Left/Right (L/R) Audio cables may appear to be just one cable, but are actually three separate cables. The yellow composite cable transfers video. The white and red L/R Audio cables, when used together, transfer stereo sound. These three cables can be used together or separately. For example, you could use an S-Video cable to transfer video and use white and red L/R Audio cables to transfer audio. In this case, you would not need to use the yellow Composite Video cable at all.

Coaxial RF Cable: A coaxial RF cable transfers both audio and video on a single cable.

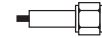

Optical (or Digital) Audio Cable: An optical (or digital) audio cable transfers audio only. This cable transfers audio at the highest possible quality from your DIRECTV DVR to an A/V receiver. If you have a home theater, own an A/V receiver capable of receiving Dolby® Digital audio, and wish to use Dolby® Digital audio, then you must use this cable. Not all A/V receivers with optical audio inputs are capable of receiving Dolby® Digital audio. An optical audio cable is not included with the DVR.



BNC Cable: A BNC Cable is similar to a coaxial RF cable and transfers both audio and video. This type of cable is not included with your DVR. However, you may already be using a BNC cable in an existing connection to your TV. If so, you can purchase an adapter that will allow you to connect BNC cables to the RF In or RF Out jacks on your DVR.



Telephone Line Splitter: The included telephone line splitter allows you to plug both a telephone and your DVR into a single telephone wall jack.



► **Video, Audio, and Electronics Equipment and Terms**

Switch Box: A switch box is a small box that allows you to connect multiple devices to your TV, even if your TV does not have enough input jacks to connect them all directly. It allows you to switch easily between viewing DIRECTV channels, viewing video from your DVD player, or running your game system. Switch boxes are inexpensive and can be purchased at electronics stores.

A/V Receiver: An A/V receiver is similar to a switch box but is more sophisticated. It may offer additional features such as remote control or Dolby Digital audio capabilities. An A/V receiver allows you to connect multiple devices to your TV, even if your TV does not have enough input jacks to connect them all directly. It allows you to switch easily

between viewing DIRECTV channels, viewing video from your DVD player, or running your game system by changing the input source.

Dolby® Digital Audio: Dolby® Digital audio is recorded on six separate channels, each of which can be heard on one of six separate speakers. To use Dolby® Digital audio, you must use an optical audio cable to connect your DIRECTV DVR to an A/V receiver capable of supporting Dolby® Digital audio. Not all A/V receivers with optical audio inputs are capable of receiving Dolby® Digital audio. You must also set your DVR to record using Dolby® Digital audio. For more information, see page 96.

Dolby® Surround Sound: Dolby® Surround Sound audio is recorded on two channels, which can be heard on two or more (usually five) speakers. To use Dolby® Surround Sound audio, you must have an A/V receiver capable of supporting Dolby® Surround Sound audio connected to your DVR using either L/R Audio cables or an optical audio cable.

Digital PBX Phone System: Digital PBX phone systems allow many phones to share a single telephone number and are usually used in hotels and office buildings. If you are installing the DVR in your home, it is very unlikely that you are using a digital PBX phone system. Do not connect your DVR to a digital PBX phone system. Doing so may permanently damage your DVR's modem and will void your warranty.

Surge Protector: Surge protectors are devices that protect electronic equipment from power fluctuations. Like all electronics equipment, your DVR can be damaged by fluctuations in your line voltage. Purchasing a surge protector is highly recommended. If you purchase a surge protector that allows you to plug in both your DVR's power and your telephone cord, you may prevent damage to the parts of your DVR that are connected to your phone line as well! Surge protectors can be purchased at hardware, electronics, or general merchandise stores.

►► Cables and Accessories

1

In addition to your television and the equipment that shipped with this DIRECTV DVR (shown below), you'll need a satellite dish antenna—which should be properly mounted before you connect the DVR—and a standard, analog phone line (see page 3 for details).

1. These are the basics:



DVR



DIRECTV Access Card



Power Cord



Phone Line Splitter

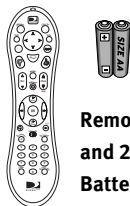

25' Phone Cord

Remote Control
and 2 AA
Batteries

2. See page 10 to choose audio/video cables. The carton contains one of each of the following:



RF Coaxial Cable



Composite A/V Cable



S-Video Cable

3. You may need to purchase these additional items for some setups:



Extra RF Coaxial Cable

Extra Composite A/V
Cables

▶▶ Setup Examples

▶ Audio and Video Cables



If your TV has only one audio connector, connect just the white and yellow ends of the Composite A/V cable (don't connect the red end).

Composite. Many TVs and VCRs have connectors for Composite A/V cables. If your equipment has them, you can use the Composite A/V cables for both audio and video.

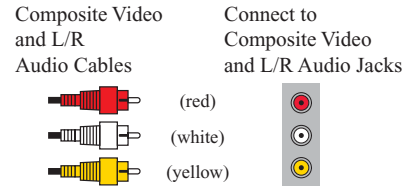

RF Coaxial. Some TVs only have connectors for RF Coaxial cable. If your TV only has an RF connector, use the RF Coaxial cable for both audio and video and see Example 4 on page 18 (or see Example 1 on see page 12 if you also have a VCR):

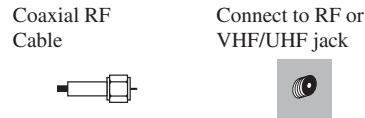

S-Video. If you have S-Video connectors on your equipment, and want the highest quality video, use the included S-Video cable. The S-Video cable carries a video signal. You can connect the red and white ends of a Composite A/V cable to carry the audio signal.

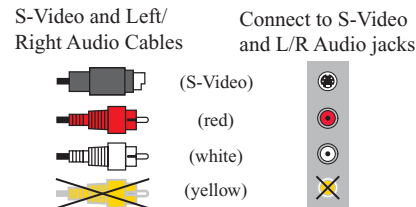

Digital Audio. The receiver includes a Digital Audio Out jack for compatibility with Dolby Digital audio. To use this feature, you will need an optical audio cable  (not supplied), and a device that accepts Dolby Digital input. The optical audio cable will carry the audio signal. To complete the setup, you'll also need a connection for the video signal. You can use an S-Video cable to make the connection (for the best video signal), or the yellow ends of a composite cable. If you use a composite cable, you do not need to connect the red and white ends of the cable.

Ordinarily, your DVR produces tones to indicate when certain buttons on the remote control are pressed or to indicate signal strength when you are positioning your dish. If you use Digital Audio Out, you will not hear these tones.

► **Setup Examples**

This chapter provides detailed examples showing how to connect the DIRECTV DVR to your existing audio/video system. Choose the example closest to your configuration and follow the steps in that section.

- **Example 1:** DVR with VCR, DVD and/or game system, and switch box or A/V receiver (see page 12)
- **Example 2:** DVR with VCR (see page 14)
- **Example 3:** DVR only (see page 16)
- **Example 4:** DVR with VCR, antenna or cable, multiple input TV (see page 18)
- **Example 5:** DVR with VCR, antenna or cable, single input TV (see page 20)

If you have trouble or if your configuration isn't covered by one of these examples, see the "Back Panel Reference" on page 152.

► **Example 1: VCR, DVD and/or Game System, and Switch Box or A/V Receiver**

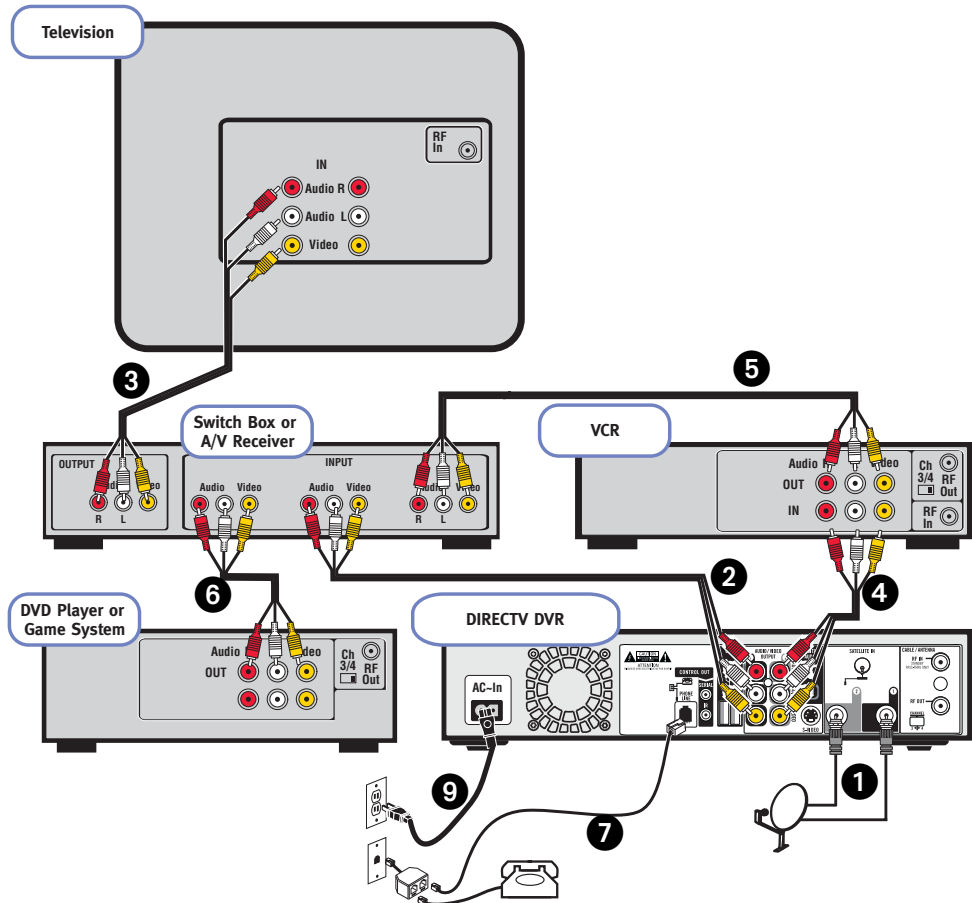

Note: Audio/Video cables shown are examples only. Use the best connections available on your equipment.

▶ **Example 1: VCR, DVD and/or Game System, and Switch Box or A/V Receiver**

- ➊ Connect the coaxial RF cables from your satellite dish antenna to the DIRECTV DVR. Connect one coaxial RF cable that comes from your satellite dish antenna to the jack labeled “Satellite In 1” on the DVR. If you have a second coaxial RF cable from your satellite dish antenna, connect it to the jack labeled “Satellite In 2.”
- ➋ Connect the DVR’s output to the switch box or A/V receiver’s input.
- ➌ Connect your switch box or A/V receiver’s output to your TV’s input.
- ➍ Connect the DVR’s output to your VCR’s input. This will allow you to save programs recorded on your DIRECTV DVR to videotape.
- ➎ Connect your VCR’s output to your switch box or A/V receiver’s input.
- ➏ Connect your DVD player and/or game system’s output to your switch box or A/V receiver’s input.
- ➐ Connect the phone line. (For more about the phone connection, see page 3.)
- ➑ Insert the Access Card that came with your DVR. Open the card door on the DVR’s front panel. Insert the card into the slot in the direction indicated on the card. Stop when the card makes contact with the back of the slot, then you can completely close the card door. To watch DIRECTV channels, you must insert the card correctly and activate it (activation is covered in the next chapter).
- ➒ Plug in all power cords. After you see the Welcome screen, skip to “Guided Setup” on page 23. If you do not see the Welcome screen, see page 119.



To switch between watching DIRECTV programming and watching video from your VCR, DVD or game system:

- With a switch box, press the buttons on your switch box
- With an A/V receiver, use the “Input,” or “Source” button on the receiver or its remote control.

If you are having trouble changing the video source, refer to the instructions that came with the A/V receiver or switch box.

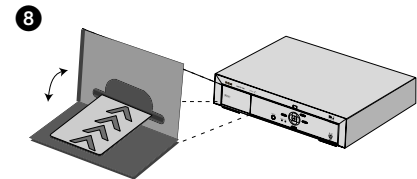

► **Example 2: DVR with VCR**

 To switch between watching your VCR and watching video from your DVR, you will need to use the “Input,” “Source,” or “TV/Video” button on your TV or TV’s remote control to change the video source. Some TVs also have a “Menu” button that allows you to change the video source using an on-screen menu.

If you have trouble changing the video source refer to the instructions that came with your TV.

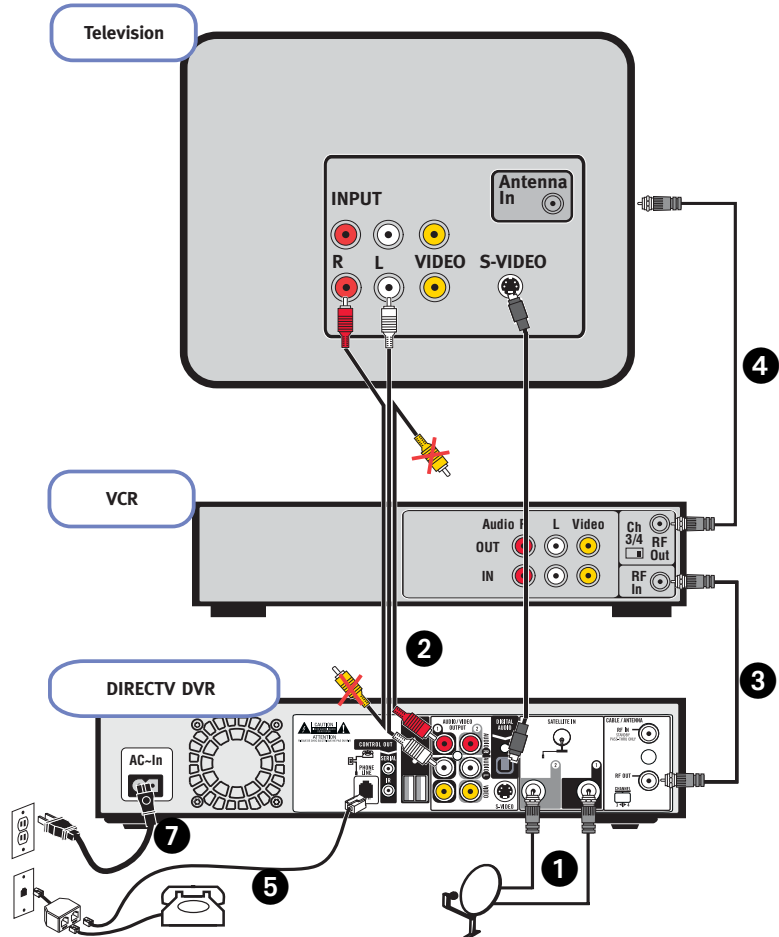

Note: Audio/Video cables shown are examples only. Use the best connections available on your equipment.

► Example 2: DVR with VCR

- ❶ Connect the coaxial RF cables from your satellite dish antenna to the DIRECTV DVR. Connect one coaxial RF cable that comes from your satellite dish antenna to the jack labeled “Satellite In 1” on the DVR. If you have a second coaxial RF cable from your satellite dish antenna, connect it to the jack labeled “Satellite In 2.”
- ❷ Connect the DVR to your TV. Look at the back of your TV and see what types of jacks are available. Connect the DVR’s output to the TV’s input using the best connection available. The example in the diagram shows a composite cable connected for audio and an S-Video cable connected for video. The connection can also be made using only a RF coaxial cable, or using only a composite cable.
- ❸ Connect the DVR to your VCR. Connecting the DVR to your VCR will allow you to save programs recorded on your DIRECTV DVR to videotape. The example in the diagram shows an RF cable running from the DVR’s output to the VCR’s input.
- ❹ Connect your VCR’s output to your TV’s input. This will allow you to watch videotapes. The example in the diagram shows an RF cable running from the VCR’s output to the TV’s input.
- ❺ Connect the phone line. (For more about the phone connection, see page 3.)
- ❻ Insert the Access Card that came with your DVR. Open the card door on the DVR’s front panel. Insert the card into the slot in the direction indicated on the card. Stop when the card makes contact with the back of the slot, then you can completely close the card door. To watch DIRECTV channels, you must insert the card correctly and activate it (activation is covered in the next chapter).
- ❼ Plug in all power cords. After you see the Welcome screen, skip to “Guided Setup” on page 23. If you do not see the Welcome screen, see page 119.

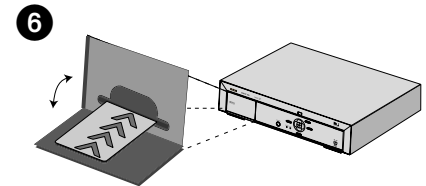

► Example 3: DVR Only

- ❶ Connect the coaxial RF cables from your satellite dish antenna to the DIRECTV DVR. Connect one coaxial RF cable that comes from your satellite dish antenna to the jack labeled “Satellite In 1” on the DVR. If you have a second coaxial RF cable from your satellite dish antenna, connect it to the jack labeled “Satellite In 2.”
- ❷ Connect the DVR to your TV. Look at the back of your TV and see what types of jacks are available. Connect the DVR’s output to the TV’s input using the best connection available. The example in the diagram shows a composite cable connected for audio and an S-Video cable connected for video. The connection can also be made using only a RF coaxial cable, or using only a composite cable.
- ❸ Connect the phone line. (For more about the phone connection, see page 3.)
- ❹ Insert the Access Card that came with your DVR. Open the card door on the DVR’s front panel. Insert the card into the slot in the direction indicated on the card. Stop when the card makes contact with the back of the slot, then you can completely close the card door. To watch DIRECTV channels, you must insert the card correctly and activate it (activation is covered in the next chapter).
- ❺ Plug in all power cords. After you see the Welcome screen, skip to “Guided Setup” on page 23. If you do not see the Welcome screen, see page 119.

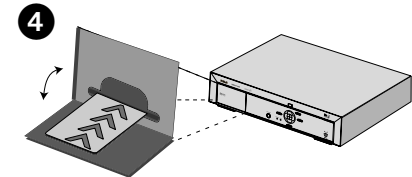



To switch between watching

DIRECTV channels and antenna/cable channels, or tapes on your VCR, use the “Input,” “Source,” or “TV/Video” button on your TV’s remote to change the video source. Some TVs have a “Menu” button and an on-screen menu that lets you change the video source.

You can watch an antenna or cable channel while recording a DIRECTV channel. You will NOT be able use DVR functions on antenna or cable channels. You will also need to use your TV’s remote control to change antenna/cable channels.

If you are having trouble changing the video source, refer to the instructions that came with your TV.

► Example 4: DVR, VCR, Antenna or Cable, and Multiple Input TV

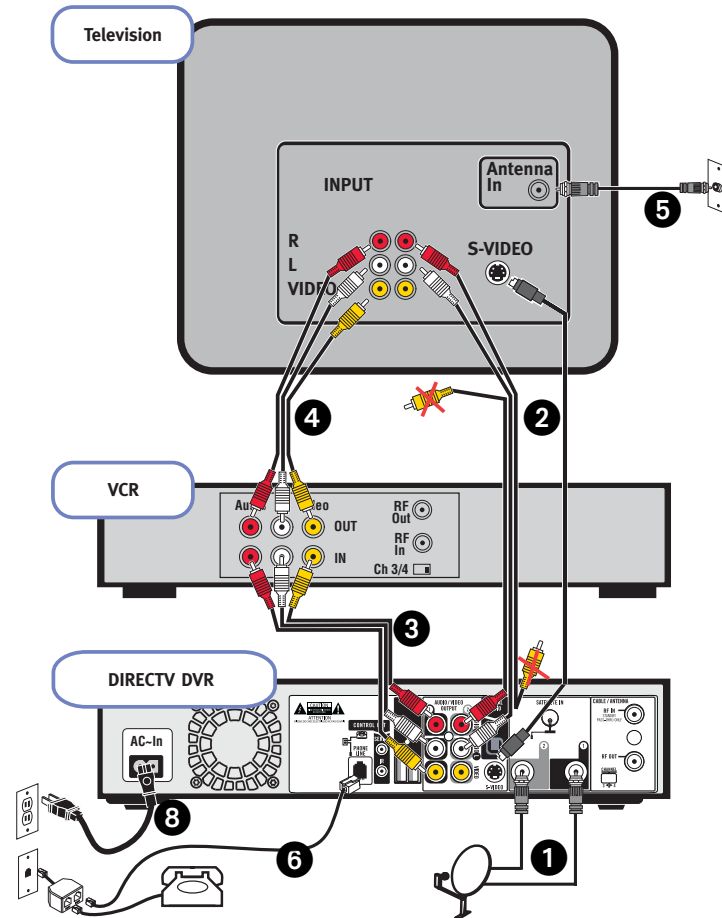

Note: Audio/Video cables shown are examples only. Use the best connections available on your equipment.
 Download from www.Somanuals.com. All Manuals Search And Download.

▶ **Example 4: DVR, VCR, Antenna or Cable, and Multiple Input TV**

If your TV has both coaxial RF and composite video inputs, follow this connection example to connect your antenna or cable to your TV. You will NOT be able to use DIRECTV DVR functions while watching antenna or cable channels, even if you connect your antenna or cable directly to your DVR.

- ❶ Connect the coaxial RF cables from your satellite dish antenna to the DVR. Connect one coaxial RF cable that comes from your satellite dish antenna to the jack labeled “Satellite In 1” on the DVR. If you have a second coaxial RF cable from your satellite dish antenna, connect it to the jack labeled “Satellite In 2.”
- ❷ Connect the DVR to your TV.
- ❸ Connect the DVR to your VCR. Connecting the DVR to your VCR will allow you to save programs recorded on your DIRECTV DVR to videotape.
- ❹ Connect your VCR’s output to your TV’s input. This allows you to watch videotapes.
- ❺ Connect your antenna or cable to the CABLE/ANTENNA RF In jack on your TV.
- ❻ Connect the phone line. (For more about the phone connection, see page 3.)
- ❼ Insert the Access Card that came with your DVR. Open the card door on the DVR’s front panel. Insert the card into the slot in the direction indicated on the card. Stop when the card makes contact with the back of the slot, then you can completely close the card door. To watch DIRECTV® channels, you must insert the card correctly and activate it (activation is covered in the next chapter).
- ❽ Plug in all power cords. After you see the Welcome screen, skip to “Guided Setup” on page 23. If you do not see the Welcome screen, see page 119.



“Multiple input” means the TV has multiple input plugs for A/V connectors.



Steps ❷, ❸, and ❹ are shown using composite and s-video cables. You can make these connections with other cables, as explained on page 10. Your DIRECTV DVR comes with one composite and one s-video cable. To complete the setup example as shown, you will need to use cables that came with your VCR, or purchase additional cables.

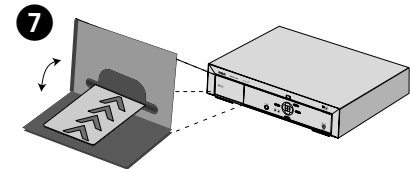

 To switch between watching DIRECTV channels and watching antenna/cable channels, or watching tapes on your VCR, use the “Input,” “Source,” or “TV/Video” button on your TV’s remote control to change the video source. Some TVs have a “Menu” button that allows you to change the video source with an on-screen menu.

You can watch an antenna or cable channel while recording a DIRECTV channel. You will NOT be able use DVR functions on antenna or cable channels. You will also need to use your TV’s remote control to change antenna/cable channels.

If you are having trouble changing the video source, refer to the instructions that came with your TV.

► **Example 5: DVR with VCR, Antenna or Cable, and Single Input TV**

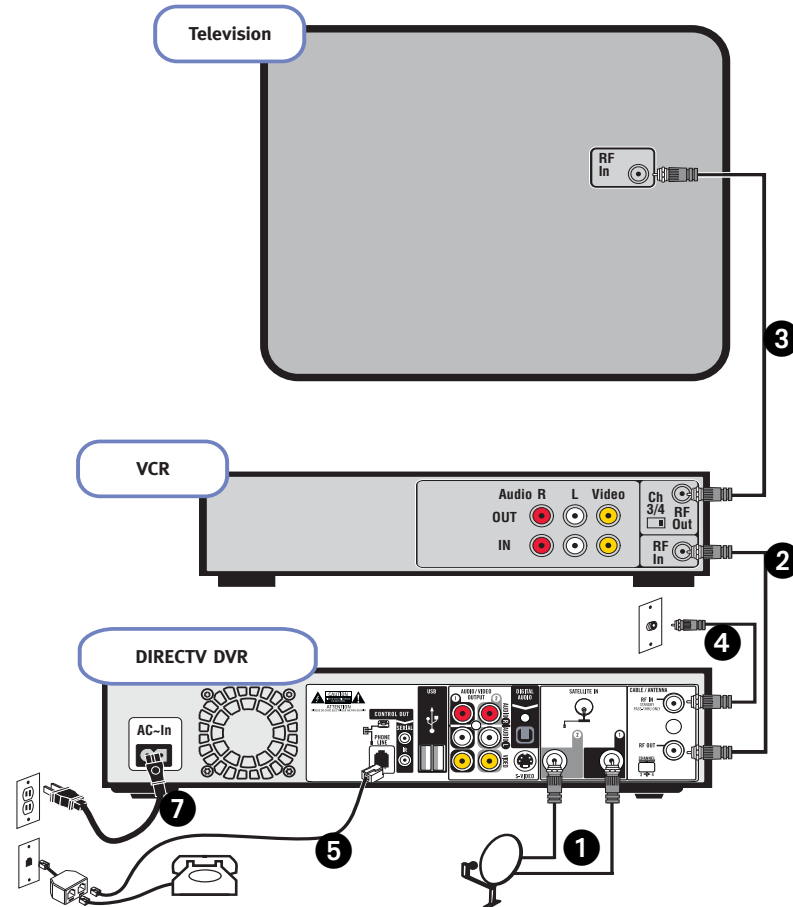

Note: Audio/Video cables shown are examples only. Use the best connections available on your equipment.

► **Example 5: DVR with VCR, Antenna or Cable, and Single Input TV**

If your TV has composite video inputs, use the example on page 18. You will NOT be able to use DIRECTV Receiver functions while watching antenna or cable channels.

- ❶ Connect the coaxial RF cables from your satellite dish antenna to the DVR. Connect one coaxial RF cable that comes from your satellite dish antenna to the jack labeled “Satellite In 1” on the DVR. If you have a second coaxial RF cable from your satellite dish antenna, connect it to the jack labeled “Satellite In 2.”
- ❷ Use coaxial RF cable to connect the DVR’s output to your VCR’s input. Be sure to select an output of channel 3 or 4 using the small switch on the back of the DVR. You will then need to set your VCR’s output to the same channel (3 or 4), and tune your TV to that same channel (3 or 4), to receive a signal.
- ❸ Use coaxial RF cable to connect your VCR’s output to your TV’s input. If your VCR is already connected to your TV, continue to Step D. Be sure to set your VCR’s output to the same channel (3 or 4) that you set on your DVR.
- ❹ Connect your antenna or cable to the RF In jack on the back of the DVR.
- ❺ Connect the phone line. (For more about the phone connection, see page 3.)
- ❻ Insert the Access Card that came with your DVR. Open the card door on the DVR’s front panel. Insert the card into the slot in the direction indicated on the card. Stop when the card makes contact with the back of the slot, then you can completely close the card door. To watch DIRECTV channels, you must insert the card correctly and activate it (activation is covered in the next chapter).
- ❼ Plug in all power cords. After you see the Welcome screen, skip to “Guided Setup” on page 23. If you do not see the Welcome screen, see page 119.



If you have a DVD player or game system in addition to your TV, VCR and DIRECTV DVR, you may need to use a switch box or an A/V receiver. A switch box or A/V receiver will allow you to connect all of your devices to your TV, even if your TV does not have enough input jacks to connect them all directly. For more information about these devices, see “Useful Terms,” on page 5.

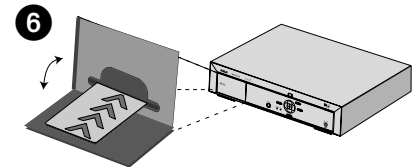

Guided Setup

Overview	24
Satellite Dish Guided Setup	25
Activate	29
Phone Setup	30



Satellite Dish Guided Setup is used to test signal strength, position

the satellite dish antenna and configure the DVR for use with a multiswitch or new multi-satellite dish antenna.



If you have connected your television or audio/visual

equipment only to the DVR's digital audio output, you will not hear any audio during Setup, or at any time while you are navigating through on-screen menus.



►► Overview

Now that you have finished connecting your DIRECTV® DVR, you are ready to begin Guided Setup. When you first plug in the DVR, screens appear which display its progress as it starts up. After a few minutes, you will see the Welcome screen, indicating that you are ready to begin Guided Setup.

During Guided Setup, you will point your satellite dish antenna (if you haven't already), activate your DIRECTV® programming and DVR service, and set up your DVR to access service updates by phone. Guided Setup includes on-screen instructions. If you need additional assistance, this chapter contains detailed directions.

Guided Setup includes three steps. They are described on pages 25-32.

1. Satellite Dish Guided Setup
2. Activating services
3. Phone Setup

► **Using the Remote Control**

To complete Guided Setup, you use the remote control to move through screens and select menu items that are on your television's display. For an introduction to the remote control, see "Introducing the Remote Control" on the inside front cover of this guide.

Welcome. When you first turn on your DIRECTV DVR, you will see a gray screen that says "Welcome. Powering up," followed by the Welcome screen (shown to the side). Read the screen then press SELECT to move to the next screen.

If you do not see the Welcome screen, see page 119.

▶▶ Satellite Dish Guided Setup

Satellite Dish Guided Setup tells the DIRECTV DVR what type of satellite dish antenna you are using, so you must go through it at least once, even if you are only replacing a DVR that was already working. Satellite Dish Guided Setup usually takes about five minutes, plus whatever time you may need to position your dish.

Connect Cables. After you press SELECT on the Welcome screen, you'll see a reminder to make sure all cables are properly connected to the DVR and to your TV. Press SELECT when you are ready to continue.

Satellite Dish Type. Choose the type of satellite dish antenna you have installed. If the manual for your satellite dish antenna is available, you can find its type there. Most people should select "Round dish (Single or Dual LNB)." The most important feature of this type of dish is that it receives a signal from one satellite in the sky. Some manufacturers produce a dish that receives a signal from one satellite but is slightly oval in shape. If you have such a dish, choose "Round dish (Single or Dual LNB)."

An oval 2 satellite dish antenna can receive signals from two satellites. An oval 3 satellite dish antenna receives its signal from three satellites. 2 and 3 satellite dish antennas are always Dual LNB. To see the next screen, highlight the type of satellite dish antenna you are using, then press SELECT.



Round dish antenna
(Single or Dual LNB)



Oval 2 satellite dish antenna



Oval 3 satellite dish antenna



Notice the progress bar at the bottom of the screen. It can help you keep track of how far along you are in Guided Setup.

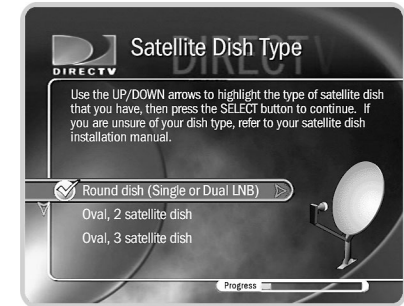

Most new satellite dish antennas are Dual LNB. One cable extends from a single LNB dish to a home; two cables extend from a Dual LNB dish to a home (or to a multiswitch).



A transponder is a piece of radio equipment on a satellite. The

DIRECTV transponders receive information from DIRECTV and rebroadcast it to your satellite dish antenna. Each transponder rebroadcasts a different set of channels. If the DVR does not receive a signal for an individual transponder, it will not be able to show that transponder's channels. Satellites may have different numbers of transponders.

Satellite Connections. If you connected an RF coaxial cable to each of the DIRECTV DVR “Satellite In” jacks, select “Two cables.” If you connected only one RF coaxial cable (to the “Satellite In 1” jack), select “One cable.” To be able to record two programs at the same time, you must connect an RF coaxial cable from the satellite dish antenna (or a multiswitch) to both of the “Satellite In” jacks and then choose “Two cables” on this screen.

ZIP Code. Use the number keys on your remote control to enter your ZIP code. The DVR uses your ZIP code to determine the direction your satellite dish antenna should point. If you make a mistake, press LEFT arrow to correct it.

Satellite Dish Direction. Based on your ZIP code and dish type, this screen shows roughly how to position your satellite dish antenna. You will fine tune the position later on during Satellite Dish Guided Setup at the Test Signal Strength screen. Before positioning the dish, be sure the mast (the pole on which the dish is mounted) is straight up and down. For 2 or 3 satellite dish antennas, the screen provides a required tilt in addition to side-to-side (azimuth) and up-down (elevation) information available for round dishes. Professional satellite installers are available in most areas to ensure correct installation. If your satellite system was installed by a professional, the satellite dish antenna direction should be correct. To see the next screen, press SELECT.

Satellite Checklist. The items on this list help ensure you receive a clear satellite signal. To see the next screen, press SELECT when you are satisfied that each item is complete.

Test Signal Strength. You use this screen to check the strength of the signal received by your satellite dish antenna. If you have two cables connected to the Satellite In jacks, it shows you the signal strength for each connection. It lets you see the signal strength from individual transponders one at a time. To be sure you receive all your channels, you should check signal strength on all transponders.

Note: You can check signal strength while you adjust the position of your satellite dish antenna. The signal strength meter on this screen provides audio feedback—a tone that becomes higher pitched as the signal gets stronger. You may be able to turn the volume on your TV up so you can hear the tone while you adjust your satellite dish antenna. Alternatively, you might have someone watching the signal strength meter and then reporting through a cell phone or walkie-talkie to the person who is adjusting the satellite dish antenna.

- To change the currently selected transponder, use the UP arrow to highlight the transponder number. Press the RIGHT or LEFT arrow to change the transponder. It is best if each transponder has a signal strength above 60.
- If you have connected both Satellite In jacks, the signal strength for each connection is shown. You should have a good signal on all transponders for both connections.

If you have a 2 or 3 satellite dish antenna, you should check the signal strength from transponders on each satellite.

- To change the selected satellite, press the UP arrow until the satellite number is highlighted. Press the RIGHT or LEFT arrow to change the satellite.

When you have finished, select “Done Testing Signal Strength.” If you cannot acquire a good satellite signal, see Satellite Signal Troubleshooting on the next page.

Confirming Setup, Satellite Info. At each of the next two screens there is a short wait while the DVR confirms your set-up then gathers a list of channels from the satellite.

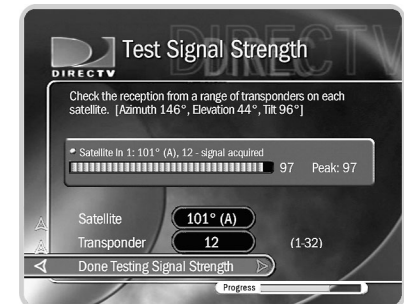
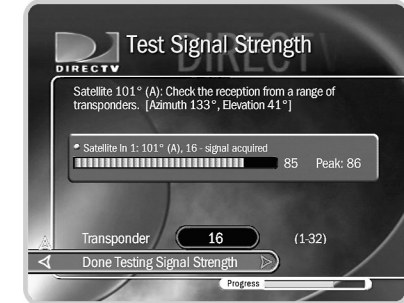
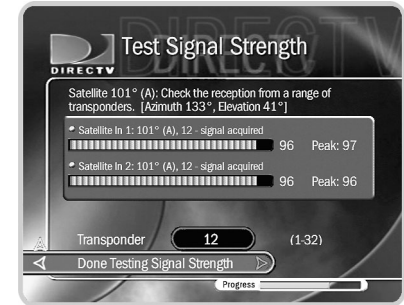



If the DVR is low on Program Guide Data, this message at the bottom of the screen tells you how much Program Guide Data it has.



Program Guide Data. Over the first 1 to 2 days, the DIRECTV DVR will gather and process up to two weeks of program data from the DIRECTV satellites. Program data includes program titles, times, channels, program descriptions, and more.

Many of the DVR's features use program data. Although you may be able to use such features immediately, you may not be able to find all the programs you are looking for right away. If programs you are looking for do not appear in the program information, check on them again after the DVR has been set up for a while.

Steps to Activate. This screen explains the next steps of Guided Setup, activation of DIRECTV services. When it appears, press the LIVE TV button on your remote control and go to the next page of this manual.

Satellite Signal Troubleshooting. If you encounter problems during Satellite Dish Guided Setup, you will see an error screen with some suggestions. For example, you may have made a mistake entering your ZIP code or your type of satellite dish antenna.

If you are trying to set up the DVR, choose one of the options that return to part of Satellite Dish Guided Setup. For example, if you received the "Satellite Info Error," choose "Try Again to Acquire Information." You can also repeat Satellite Dish Guided Setup. This allows you to check that your ZIP code and satellite dish antenna are correct. If you repeat Guided Setup and still receive error notifications, it is possible that your satellite dish antenna is not pointed correctly or the dish or multiswitch is miswired. Check the cabling, or consult a professional satellite system installer.

If you are trying to bypass Satellite Dish Guided Setup—for example, if you are setting up the DVR in a place without a satellite signal—the bottom choice on the error screens allows you to continue without resolving potential problems. While you may receive fewer or no TV channels, you can still watch previously recorded programs.

▶▶ Activate

Now it's time to activate services for your DIRECTV DVR. Before you make the phone call:

- The DVR should be on, tuned to channel 100, and receiving a signal from the satellite dish antenna. (Channel 100 shows preview programming from DIRECTV.)
- You will need: a valid service address, social security number, and a major credit card (deposit or prepayment may be required). You will also need the 12 digit number on your DIRECTV access card and the make, model, serial number, and 12 digit Receiver ID number of your DVR, found on a label on the back of the DVR and on the System Information screen. (Press the DIRECTV button, then select "Messages & Setup" then "System Information.")
- **Important!** The access card that came with your DIRECTV DVR must be inserted in the appropriate slot in front of the DVR before you call. Also, be sure to tell your customer care agent that you have a "DIRECTV DVR" and that you also want to activate the DIRECTV® DVR with TiVo® service. Without the DVR service, your DVR will not be able to record programs.

When you are ready, call 1-800-DIRECTV. After you have activated, you can begin Phone Setup, the last step of Guided Setup, by pressing the DIRECTV button.

▶ **What does DIRECTV® DVR with TiVo® service provide?**

The DVR service provides you with the ability to record programs, create Season Pass recordings and WishList™ searches. It also gives you access to Showcases, TiVo Suggestions, and several convenient ways to find programs to you want to record. Without the DVR service, the unit functions only as a DIRECTV Receiver, without recording capability.



Remember to place the access card in the appropriate slot in front of the DVR. See the setup examples in chapter two for details.

►► Phone Setup

Press the DIRECTV button on your remote control to start Phone Setup.

Final Steps. The last step of Guided Setup, Phone Setup, begins automatically the first time you press the DIRECTV button on your remote control. The DIRECTV DVR should be connected to a telephone line. The DVR occasionally makes a brief phone call to get updates to the DVR service and Showcases, and for pay per view functionality.

By default, the DVR will not pick up the phone if the line is busy. If you pick up the phone while the DVR is using the line, the DVR's modem will disconnect. To use the phone line you should hang up, wait at least 45 seconds, then pick up the phone again to get a dial tone.

DVR Service Terms. This screen appears after the Final Steps screen. The DIRECTV Service Agreement is printed on your first monthly statement from DIRECTV. We encourage you to read it.

Area Code. The DVR service uses your area code to determine which local dial-in numbers are available. If you make a mistake, press LEFT arrow to correct it.

Phone Dialing Options. Most people will not need to change the settings the DVR uses to dial out. However, if your phone system uses special dialing options, select "Yes." See "Phone Dialing Options" on page 102 for help with the various settings.

Update Dial-In Numbers. The DVR makes a toll-free call to get a list of local dial-in numbers. The call usually takes less than five minutes, and its status displays on the screen. If the call fails, check the Troubleshooting chapter of this guide, on page 132.

Dial-In Numbers. The DVR uses the dial-in number you select from the list on this screen to make its daily calls to the DVR service. The list may be too long to fit on one screen. To see more numbers, press CHAN DOWN.



No Local Numbers. If you chose a local dial-in number, you will not see this screen. If you selected “None of the Above” on the Dial-In Numbers screen, select “Request 800 number authorization” here. Selecting this option temporarily selects the toll-free number and submits a request to use the toll-free number. It is the current policy of DIRECTV to allow you to use the toll-free number if there are no local numbers available.

Dialing Format. Choose the dialing format you need. For example, should the dial-in number be preceded by your area code, and should a “1” precede the area code? In some areas, even local numbers must be dialed using the area code.

Test Phone Connection Call. This screen appears while the DVR tests the phone dialing options and local dial-in number you have chosen. You should see a message that says “Test Successful!” Press SELECT or the RIGHT arrow to continue. If the phone test does not succeed, you may need to pick a different dial-in number, or change the dialing format. Use the LEFT arrow to go back to previous screens and make changes to dialing options.

Congratulations! You’ve completed Guided Setup. You can now press the DIRECTV Button on your remote control to go to DIRECTV Central.

Care of Your DIRECTV DVR. Your DVR should remain connected to your satellite dish antenna and plugged in to a live power source and a phone line at all times. This lets it record programs and make phone calls to keep its data up-to-date.

Moving Your DVR. If you take your DVR with you to a location without satellite access—for example, on a weekend get-away to a mountain cabin—you will still be able to connect it to a television and watch programs saved in the Now Playing List.

After completing Guided Setup one time, whenever you unplug the DVR and plug it back in, it will search for a satellite signal. When you see the message “Acquiring Satellite



If your DVR is having difficulty dialing out, try the following: Press

LEFT arrow until you return to the Phone Dialing Options screen. Select Set Dial Prefix, and enter the dialing prefix “,#034” (comma, pound, zero, three, four). Use the PAUSE button to enter a comma, and the ENTER button to enter a pound. This command sets the DVR’s modem to a slower speed, which helps phone calls succeed in some environments. The DVR does not dial the prefix as part of the number.

2

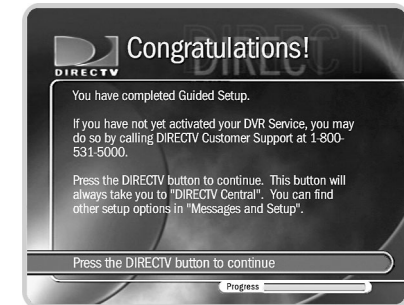

Information,” you can press the DIRECTV button on the remote control to go directly to DIRECTV Central. From DIRECTV Central, programs in your DVR’s Now Playing List are always available. If you start your DVR without properly connecting it to a DIRECTV satellite television signal, the DVR will not show live TV or provide any live TV functions.

Your DVR should NOT be used with any digital PBX phone system. Doing so may permanently damage your DVR’s modem and will void your warranty. Digital PBX phone systems allow many phones to share a single telephone number and are usually used in hotels and offices. If you are installing the DVR in your home, it is unlikely you are using a digital PBX phone system.

Next Up, the 5 Tours. Now that you are finished with Guided Setup, you’re ready to have fun with your DVR! We suggest you start with the five short tours provided in “The Basics in 5 Short Tours” on page 33. These will guide you through the basics and show you some fun features of the DIRECTV® DVR.

The Basics in 5 Short Tours

Tour 1: Play with Live TV	34
Tour 2: DIRECTV Advanced Program Guide™	36
Tour 3: Find and Record Your Favorite Programs	38
Tour 4: Search for New Programs	40
Tour 5: Now Playing List	42
Cool Things You Can Do	43

▶▶ Tour 1: Play with Live TV

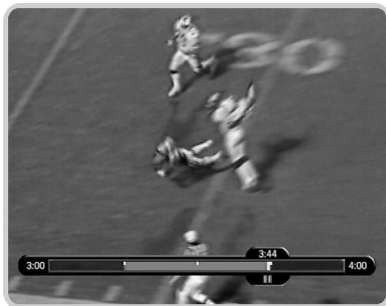
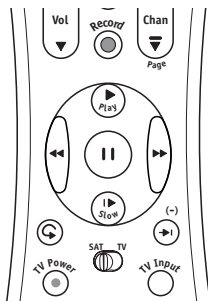

In this tour, you'll take a look at how you can control live TV. So grab your remote!

First, press the PAUSE (⏸) button—the program you're watching pauses. Now you can stand up and stretch, or go to the kitchen and get a snack. You can pause live TV for up to 30 minutes! With Dual Tuner, you can switch between two channels in live TV without losing the saved portion of either one.

But for now, press PLAY (▶) and the program resumes.

Next, press BACK (◀◀) and the program rewinds. Press BACK a second time—it goes faster! A third time—faster still! Both the FORWARD (▶▶) and BACK buttons have three speeds. Press BACK a fourth time to return to normal speed.

Press PAUSE once more, then immediately press FORWARD and you get frame-by-frame forward! Press BACK and you get frame-by-frame backward! When your show is paused, FORWARD and BACK let you go frame by frame. Press PLAY to resume watching at normal speed.

Try out the INSTANT REPLAY button. INSTANT REPLAY (↺) jumps you back 8 seconds—useful for when you miss a great sports play or a bit of dialog, or for when you fast forward too far.

Press INSTANT REPLAY again, then immediately press SLOW (⏪) — you get your own slow-motion replay!

Finally, try the ADVANCE (⏩) button. Presto! You're caught up to live TV.

► **Status Bar**

Press PAUSE or PLAY to see the status bar. It shows a one-hour period. The green segment is the portion of the current hour that has been saved by your DIRECTV® DVR. The right edge of the green part is always the current time.

The white line marks the part of the program you are currently watching. If it is anywhere back in the green segment you are “behind” real time.

Press CHAN UP. When you change channels, the DVR starts to save what is showing on the new channel. With Dual Tuner, 30 minutes of live TV is saved on both tuners. That means you can use the instant replay, slow motion and pause features on either channel. If you leave one of these two channels, however, the saved information on the original channel is cleared, and the DVR starts saving live TV on the new channel.

► **Channel Banner**

The channel banner describes the program you’re currently watching. Press INFO or the RIGHT arrow to see the channel banner. The channel banner is only there for a few seconds, but you can bring it back by pressing INFO or the RIGHT arrow again. While the banner is visible, press the RIGHT arrow to switch from a small, to medium, to large banner. Each version has a different amount of information.

Keep pressing the RIGHT arrow until you see the largest version of the channel banner. Notice the small icons on the right side. Each symbol represents a useful feature, like swapping tuners or setting Parental Controls. Press the UP and DOWN arrows to highlight different icons. Pressing SELECT while an icon is highlighted will take you to that feature. Finally, press the EXIT button—the channel banner disappears. (EXIT gets rid of graphics that aren’t part of the program you’re watching.)

Now go have fun playing with live TV, then come back for the next tour!



Status Bar

This white line tells you where you are.

channel banner



selectable icons

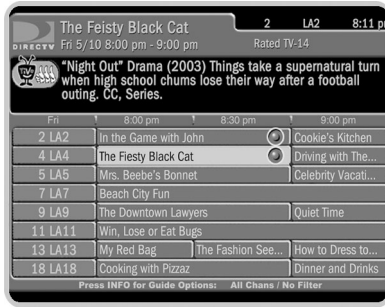

If you find that the Program Guide or the CHAN UP/DOWN buttons are not showing channels you want to see, filtering or a custom channel list is probably turned on. Check the Guide Options (from the Program Guide, press INFO).

▶▶ Tour 2: DIRECTV Advanced Program Guide™

While you're watching live TV, the Advanced Program Guide lets you see what's on, change channels, schedule recordings, and more. To see it, press the GUIDE button on your remote control.

▶ Changing Channels

The guide shows a list of channels on the left and different times across the top. One program is highlighted—it's a different color than the others. Its description appears at the top of the grid. Press the UP or DOWN arrows to move to a different channel, then press SELECT. Pressing SELECT on a program that is currently showing changes the channel to display that program and hides the guide.

▶ Scheduling a Recording

Press the GUIDE button to bring back the Program Guide. It's easy to record a program using the guide. Simply highlight the program you want and press the RECORD button. A transparent screen appears, from which you select "Record this Showing." If the program is currently playing, the DVR changes channels and begins recording; otherwise, the recording is scheduled for the future. When you're recording, the red light on the front of the DVR illuminates.

▶ Making a List of Favorite Channels

You can create a list of your favorite channels and then set the guide to show only channels that are on the list. This is a quick way to see programs coming up on the channels that are most important to you.

First, create a list of favorite channels. Press the DIRECTV button to see DIRECTV Central. Highlight “Messages & Setup,” then press SELECT. Next, select “My Preferences,” then “Customize Channels,” then “Favorite Channels.” A list of all DIRECTV® channels appears. (DIRECTV provides many, many more channels than will fit on one screen!) Press CHAN DOWN a few times. Each time you press it, you see the next screen of channels. Press CHAN UP to see a previous screen. You can also jump to a specific channel by entering the channel number on the remote.

Highlight a channel you want to include in your list of favorites and press SELECT. A checkmark appears beside the channel. To remove a channel, highlight one that has a checkmark and press SELECT—the checkmark disappears. Now find a few more channels for your list and select them to give them checkmarks.

► Using Your Channel List

When you want to change the way the guide appears and what it displays, you can use Guide Options. Press the GUIDE button to see the guide. While it is visible, press the INFO button to see Guide Options.

On the Guide Options screen, press the DOWN arrow once so “All” (to the right of “Channels”) is highlighted. “All” is the current channel list and includes all available DIRECTV channels. Press the RIGHT arrow twice to change the list to “Favorites,” then press SELECT. “Done changing options” becomes highlighted. Press SELECT again and *voilà*, the guide appears using your new custom channel list!

Now the guide only shows channels in your list. Use the UP and DOWN arrows to move around a bit on your new customized guide, then press the EXIT button to hide the guide. Press CHAN UP a few times—notice it skips some channels now. CHAN UP/DOWN is also affected by the channel list; it only tunes to channels that are on the list. You can still tune to other channels by entering numbers.





If you do not see the program you wish to find in the list of programs, it may be because the DVR is still gathering Program Guide data. A message at the bottom of the screen will tell you how much data the DVR has. The DVR should be done collecting Program Guide data within 48 hours of finishing Guided Setup.

▶▶ Tour 3: Find and Record Your Favorite Programs

You can always record a program you're watching by pressing the RECORD button on your remote control. What's more, if you have not changed the channel for a while, your DIRECTV DVR will add to your recording whatever part of the program it has already saved, up to 30 minutes. Your DVR also provides many ways to quickly search large numbers of programs, find your favorites, and schedule recordings in advance. Even buying and recording pay per view events is quick and easy, without any need to use a phone. What's more, if a program is part of a series, you can get a Season Pass™ to the series. A Season Pass records every episode of a selected program that airs on a given channel.

▶ Search by Title

In this tour, we'll show you how to get a Season Pass. As an example, we'll be searching for a fictitious show called *The Downtown Lawyers*, but you can use the same steps to search for your favorite program.

To get started, press the DIRECTV button to see DIRECTV Central. Press the DOWN arrow to highlight Pick Programs to Record. Press SELECT. The Pick Programs to Record screen appears. As you can see, there are many ways to search for a program. Since you know the program's title, highlight Search by Title and press SELECT. The next screen lets you limit your search to any of several categories, but for now, choose "All Programs" and press SELECT.

The next screen has a picture of an alphanumeric keypad. Notice the white box around the "A". Use the RIGHT, LEFT, UP, and DOWN arrows to move the box. To find *The Downtown Lawyers*, you would move the box to "D" and press SELECT. A list of programs appears on the right side of the screen. (Notice, the list alphabetizes without "A")

or “The.”) Move the white box to “O” and press SELECT again. The list changes. Your DVR searches through all available programs (usually, data for the next two weeks) to find those that begin with “DO,” then lists those programs. This can be a great way to find a show if you are not sure of its full name.

If you make a mistake entering text, select “DEL” on the screen (or press BACK on the remote control). To clear all text, use CLR on the screen (or press the CLEAR button on the remote control). Next, enter a “W.” If *The Downtown Lawyers* existed, you would see it in the title list at the right. Press the RIGHT arrow until you move off the alphanumeric keypad and onto the list of programs. Press the UP or DOWN arrow to highlight the show of your choice, then press SELECT. The Program Information screen appears. This screen tells you about the program and lets you set up a recording.

Highlight Get a Season Pass, and press SELECT. A screen appears to confirm your choice. Confirmation screens help you make sure the DIRECTV DVR is doing what you want. Press SELECT again. You now have a Season Pass.

To see all your scheduled recordings, go to DIRECTV Central, then Pick Programs to Record, then To Do List. To cancel a recording, highlight it and press SELECT. The Program Information screen appears. Select “Cancel only this episode.” On the next screen confirms that the recording has been deleted from the To Do List. Press select to return to the To Do List. To cancel an entire Season Pass, go to DIRECTV Central, then “Pick Programs to Record,” then “To Do List.” Select a program, then select “Cancel/edit the Season Pass.” Select “Cancel this Season Pass.”

► Pay Per View

You can order pay per view events using your remote control. Some events have dedicated channels that allow ordering more than 24 hours in advance, but for most events, pricing information becomes available within 24 hours of the event’s air-time. Once that information is available, you can select and record the event as you would any other program. When you select an event, a special pay per view Program Information screen will appear with options to purchase it. For a complete description, see page 85.



 **There may be more than one listing for the show you are searching for. Select the one that airs new episodes of the show on a channel you**



▶▶ Tour 4: Search for New Programs

Your DIRECTV® DVR helps you find what you want to watch—both exciting new shows and old favorites you might have forgotten.



▶ **Showcases**

Showcases list the best programs offered by television's biggest networks. These Showcases group programs in theme packages, giving you one-stop-shopping convenience when browsing for programs to record. Packages include the biggest blockbuster movies, mini-series, hottest specials, hit series and shows from the greatest stars on TV, as well as special Showcases featuring entertaining and informative video. Showcases are updated during your DVR's daily phone call.



Once you're inside a Showcase, use the arrow buttons and SELECT to explore the selections. When you get to a list of programs, select a title to see the Program Information screen. If the program airs on a channel you receive, you can set up a recording here—it's that easy!

TiVolution Magazine®. You'll always find something fun and unusual in TiVolution Magazine, an interactive guide to the best upcoming shows on television. You'll find premieres, specials, and offbeat gems, making it easy for you to schedule recordings. New content is delivered fresh to your DVR during the daily phone call. TiVolution Magazine is always available under Showcases. To find it, press the DIRECTV button, select "Showcases," then "TiVolution Magazine."

► **TiVo Suggestions (Thumbs Up and Thumbs Down)**

TiVo Suggestions is a personalized list of shows selected to match your preferences. How is this magic possible? Any time you watch programs, live or pre-recorded, or browse programs with the Program Guide, you can rate them. If you like a program, press the green THUMBS UP™  button on your remote control. If you dislike it, press the red THUMBS DOWN™ . You can give a program up to three Thumbs, up or down.

Over time, the more shows you rate with your Thumb buttons, the better TiVo Suggestions will be at finding programs you like. The suggestions are listed under TiVo Suggestions in order of how closely they match your preferences.

Try it! Press GUIDE to bring up the DIRECTV Advanced Program Guide™. Highlight a few programs and rate them by pressing the THUMBS UP™  or THUMBS DOWN™  button. Then go to “DIRECTV Central,” then “Pick Programs to Record,” then “TiVo Suggestions.” Suggested programs based on your Thumb ratings appear in TiVo Suggestions. (If you don’t see programs yet, come back later—it may take a few hours the first time.) You can press SELECT on a suggestion, then set up a recording.

As an added bonus, when the DIRECTV DVR® has empty space, it may automatically record some of TiVo Suggestions. You will find them at the bottom of the Now Playing List, below programs you requested. TiVo Suggestions never replace shows you explicitly request and they do not prevent those shows from being recorded. Recorded suggestions are always the first programs deleted to make room for recordings you request.



 **Your personal TV preferences are just that: personal. (DIRECTV privacy policies are included in your first monthly statement.)**

►► Tour 5: Now Playing List



Your DIRECTV DVR can record many hours of programming. (Enough to fill a slew of video tapes!) Fortunately, it also labels and organizes all those saved programs. Unlike a VCR, the Now Playing List on your DVR gives you instant access to all recorded programs—no need to spend time searching for an episode on that tape you thought you used.

To go to the Now Playing List, press the LIST button. Programs you recorded are at the top of the list, in the order they were recorded. An icon (like this one: ) to the left of a program's title tells you the recording's current status. (For a summary of what these icons mean, see the inside back cover of this guide.)



Programs you request will appear in the Now Playing List the moment recording begins. You can watch any title in the list—even one that is still being recorded—by highlighting it, then pressing the PLAY button.

Try it! Highlight a program in the Now Playing List and press PLAY. OK, now for the cool part: Watch the program for at least five minutes, then press the LEFT arrow to go back to Now Playing List. Select the same program again—the Program Information screen says “Resume Playing” instead of “Play.” Select “Resume Playing” and return to the program from the point you left it!

Save until . . . Programs you choose to record are saved at least two days by default. To see options for saving a program longer, highlight the program in the Now Playing List, then press SELECT.

The Program Information screen appears. Select “Save until...” On the next screen, use the UP/DOWN arrows to highlight the date, then use the RIGHT/LEFT arrows to change it. When you are done, press SELECT.

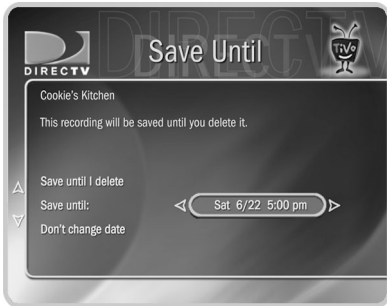

►► Cool Things You Can Do

Never be late for your favorite programs: Working late? Stuck in traffic? Don't worry. If you set up a recording or a Season Pass, the program will be waiting for you in the Now Playing List. You can even start watching from the beginning while it finishes recording.

Make your television wishes come true with a WishList™: Have a favorite actor? A favorite hobby or interest? How about a favorite sports team? If they're on TV, chances are a WishList™ will find them. See page 73.

Looking for good movies? Kids' shows? Science fiction? With Search by Title, you can browse all the upcoming programs in a particular category and find shows you didn't know were on (see page 38).

See a good preview, record the show: If you're watching live TV and a promotion comes on for an upcoming program, you may see an iPreview™ icon like this one:  Press THUMBS UP while you see the icon to automatically set up a recording for the program. You don't have to remember when it's on—it will be recorded! (If you didn't schedule a recording when you saw the icon, rewind until it's visible again.)

Filter the Program Guide: Want to try something new for dinner tonight? It's easy to make the Program Guide show only a certain kind of program—for example, cooking shows. You'll use the Guide Options screen to choose the desired filter (in this example, it's "Lifestyles," then "Cooking") and turn on filtering. (See page 50.) Once you've turned on the filter, programs that do not fit the selected category appear in gray on the guide until you highlight them. In addition, if a given channel doesn't have any shows that fit the category within the next six hours, that channel doesn't show up in the guide. You can always turn filtering off to show all channels in the guide.



Use the Overtime Scheduler™ (and don't miss overtime!): Programs sometimes start before they're supposed to and often end later than scheduled. With Recording Options, you can “pad” your recordings to account for variations by using the Overtime Scheduler.™ See page 62.

Use the EXIT button: The EXIT button hides the status bar, guide, channel banner, and anything else that is not part of the program.

Record two programs at the same time with Dual Tuner! Your DIRECTV DVR has two tuners—which means it can record programs on two channels at the same time. To activate both tuners, both Satellite In jacks on the back of the DVR must be connected to cables from your satellite dish antenna (or a multiswitch), and you must choose the “Two cables” option in of Satellite Dish Setup (described on page 25). With dual tuner you can watch more of your favorite programs, even when they're on at the same time.

The Star and the Clapboard: You will occasionally see a yellow star () on DIRECTV Central. The star signals a new selection that may change the next time you visit. Depending on the selection, it may allow you to record a program, watch a preview, or go to a special Showcase. Don't worry if you pass up a particular new selection; keep going back to DIRECTV Central until it appears again.

The clapboard icon—on DIRECTV Central, or in a Showcase—indicates that a selection includes a video preview. If the clapboard has a green triangle in it () , you can press PLAY to play the video. If there is no green triangle, the current selection takes you to another screen where you'll find the actual video clip.

Watching Live TV

Let's Go!	46
DIRECTV Advanced Program Guide™	48
Channel Banner	51
Play with Live TV	52
Status Bar	53
Music Channels	54
Standby	55

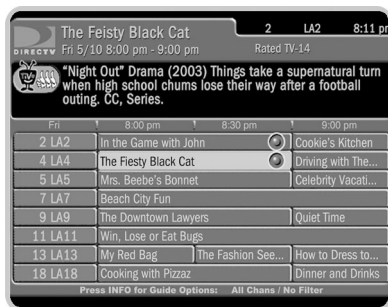

Your DVR automatically saves up to

30 minutes of live TV on the

channel you're watching. With Dual Tuner,

you can switch between two channels,

and 30 minutes of live TV will be saved on

each channel. If you leave one of these

two channels, the saved information on

the original channel is cleared, and the

DVR starts saving live TV on the new

channel.

▶▶ Let's Go!

Here are two ways to watch live TV:

- Press the LIVE TV button on your remote control.
- From DIRECTV Central, highlight Watch Live TV and press SELECT.

▶ Changing Channels

There are a number of ways to change channels—choose what's easiest for you:

- Tired of channel surfing? Press GUIDE to bring up the Advanced Program Guide™. Then highlight a program in progress and press SELECT.
- You can also change channels by pressing the numbers on your remote control. The channel automatically changes after a few seconds, or you can press ENTER/LAST to make the change right away. If you make a mistake, press CLEAR to clear numbers you have entered. Use the ADVANCE button (⊕) for long channel numbers that include a dash, to separate the primary digits from the other digits.
- Use the CHAN UP/DOWN button on your remote control to tune to channels on the current channel list.
- To jump back to the previous channel you were on (without entering any numbers), press ENTER/LAST.

► **Recording a Live Program**

To start recording a program while you're watching it, press RECORD. From the options that display, choose "Record this showing." Or you can choose "Season Pass and other options" to see the Program Information screen and either get a Season Pass (page 59) or change Recording Options (page 60). The recording will stop automatically when the program ends. You can stop it before that by pressing the RECORD button. A transparent screen will appear with a selection to "Stop the current recording." You can also select a program in the Now Playing List, and then choose "Stop recording."

Even when you are not recording a program, the DVR saves up to 30 minutes of live TV from the current channel. If you change channels and you have Dual Tuner enabled, the DVR starts saving on the new channel as well. When you start to record a live program, if the DVR has saved a portion of that program, it adds what has been saved to the beginning of your recording.

With Dual Tuner, if you're switching between two channels by using the DOWN arrow, the DVR saves up to 30 minutes of live TV on both channels. If you move to a new channel (that is, a third channel), the saved portion on the first channel is cleared, and the DVR starts to save live TV on the new channel (in addition to the other most recent channel you were watching). You can use the fast forward, instant replay, and slow motion features on either of the two current channels.

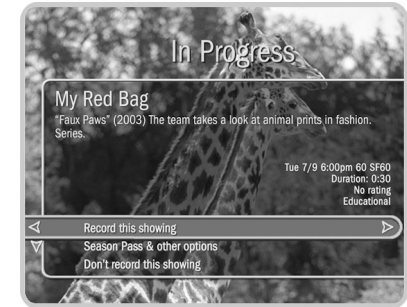

4



As soon as the DVR starts recording a program, you can find that recording on the Now Playing list by pressing the DIRECTV button twice.

▶▶ DIRECTV Advanced Program Guide™

While you are watching live TV, the Advanced Program Guide™ shows you current and upcoming programs. You can use it to see what's on, change the channel, schedule a recording, purchase and/or record pay per view events when pricing information is available, alter Thumb ratings, or select a channel filter. The guide has program information for up to the next two weeks.

To display the guide, press the GUIDE button. To hide the guide, press GUIDE again (or press EXIT).

There are two styles of the Advanced Program Guide™: the Grid Guide and the List Guide. They provide similar information. The Grid Guide is the default style. You can choose the one you prefer when you customize the guide (see page 50).

Use the UP, DOWN, RIGHT and LEFT arrows to move through the guide. Use CHAN UP/DOWN to page up or down. On the Grid Guide, use the FORWARD and BACK buttons to jump through programming information 90 minutes at a time. (On the List Guide, the FORWARD and BACK buttons jump through 30 minutes of programming information at a time.)

Changing channels. To change the channel you are watching while in the guide, highlight a program in progress and press SELECT.

Recording a program. If the program is in progress, highlight it in the guide and press RECORD. If the program is on later, highlight it and press RECORD or SELECT. If the program you have chosen is not a pay per view event, a transparent screen displays. Select "Record this showing." If you have chosen a pay per view program, the pay per view screen displays.

Grid Guide

Title, date, time the program airs, and other applicable information (rating, alternate audio, CC, Dolby Digital)

Channel number and channel call letters

Guide options (Push INFO button to set)

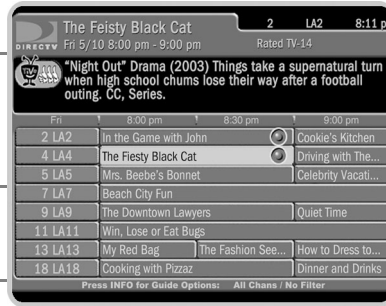

Program description and Thumb rating

Time slots

Program listings

Channel list and category filter currently in use

List Guide

Current time

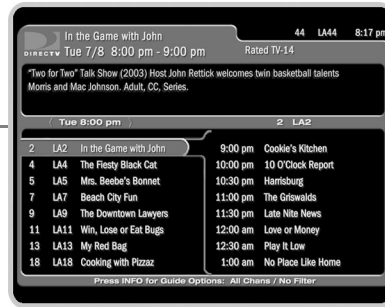

Selected channel

Programs during this time slot

Upcoming programs on the selected channel



The following icons may appear beside programs in the guide:



This appears beside pay per view events that are All Day Ticket replays.



This appears beside programs that have an alternate audio track.



This appears beside programs that have a Dolby Digital sound track.



This appears beside programs that are broadcast in letterbox format, which displays the full width of the program and leaves a black margin at the top and bottom of the screen.

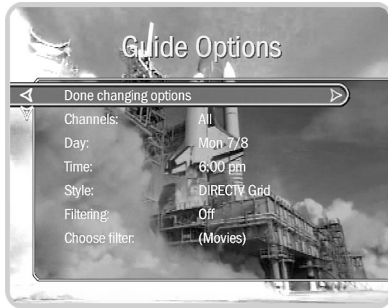

By customizing the guide, you can use it to display only program information you want to see. For example, you can use the movie filter to quickly check what movies are on, or use the “Favorite Channels” list to see information for your previously selected channels.

► **Customizing the Guide**

Guide Options. By customizing the guide, you can choose to use either the Grid Guide or the List Guide. You can also change the day and time displayed, select a channel list, and set the guide to filter program information by category. To customize the guide, press GUIDE to make it visible, then press INFO to see Guide Options. Highlight an option and then change it with the LEFT and RIGHT arrows. Save your changes by pressing INFO again or GUIDE. To discard your changes, press EXIT.

- **Channels.** Select a channel list to use in the guide (“All,” “Channels You Receive,” or “Favorite Channels”). The default, “All,” displays all of the DIRECTV® channels. If you have customized the Channels You Receive list in My Preferences to include only channels you receive, you can select “You Receive” on this screen to show only channels you receive in the guide. Similarly, if you have customized the “Favorite Channels” list, the guide will only show channels in that list.
- **Day and Time.** Use the LEFT and RIGHT arrows to change the day or time displayed in the guide.
- **Style.** Change the style of the guide to Grid Guide or List Guide.
- **Filtering.** Turn guide filtering on or off.
- **Choose filter.** Choose a category with which to filter the guide. When filtering is on, programs that do not fit the selected category appear grayed on the guide until you highlight them. In addition, if a channel has no programs in the selected category within six hours of the time on the guide, the Grid Guide will not show that channel.

▶▶ Channel Banner

The channel banner appears at the top of the screen when you change channels or press INFO, THUMBS UP or THUMBS DOWN, or the RIGHT arrow during a program. It disappears after a few seconds. You can set a preference (see page 96), to decide how long the banner stays on the screen when you change channels. Press EXIT (or INFO) to hide the channel banner.

Use the RIGHT arrow to cycle through three versions of the channel banner: small (with only the current time and channel), medium (adds the title, running time, and ratings), and large (with a program description and icons for useful shortcuts). The size of the banner you last viewed becomes the default size when you change channels.

Channel Banner Shortcuts. The large channel banner has a number of selectable icons. To select an icon, use the UP and DOWN arrows to highlight it, then press SELECT.



Select to start a recording. This icon is bright when the DVR is recording a program, dim when it is not recording.



Select to display what's on the other tuner (for Dual Tuner). This icon is bright if the program on the other tuner is being recorded. It is dim if the program on the other tuner is not being recorded.



Alternate audio usually changes the language of the program. Sometimes there are other types of alternate audio. If an alternate audio track is available, this icon will be bright, otherwise it will be dim. Highlight this icon and press SELECT to choose an alternate audio track.



Select to display Parental Controls (see page 90). If Parental Controls are off, the padlock appears unlocked and dim. If they are on, it appears locked and bright. If they are temporarily turned off, it appears unlocked and bright.



If this icon is bright, you have new messages. Select to display Messages & Setup.



Pressing the RIGHT arrow cycles through channel banner styles, from

small ...

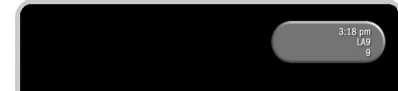

to medium ...



to large ...











▶▶ Play with Live TV

 The **INSTANT REPLAY** button has many uses but one of the most helpful is to compensate when you fast forward too far. Press **INSTANT REPLAY** to rewind eight seconds. Press it again if you really missed the mark. (You could rewind through a whole program using only **INSTANT REPLAY**!)

 **WARNING TO PROJECTION TV OWNERS!** Be careful about using the pause feature for long periods of time if you have a projection TV. Most projection TVs are sensitive and “burn in” still images very quickly. If you pause your program for too long, you may permanently damage your screen.

Part of the fun of watching live TV and recorded programs with your DIRECTV® DVR is using the pause, instant replay, and slow motion features. Here’s a list of the things you can do with the special buttons on your remote control:

-  **Record:** Records a program. You can press **RECORD** when you are watching a program in live TV, or when a program title is highlighted on the guide.
-  **Play:** Shows programs at normal speed. The status bar appears for five seconds.
-  **Pause:** Freezes the picture. To resume, press **PLAY**, or press **PAUSE** again.
 - Frame-by-Frame:** To move frame-by-frame: first press the **PAUSE** button. Then press either the **BACK** or **FORWARD** button. For continuous frame-by-frame back or forward, hold down the **BACK** or **FORWARD** button.
-  **Back:** Plays the program in reverse. Press **BACK** once, twice, or three times to go backward fast, faster, or fastest.
-  **Forward:** Plays the program in fast forward. As with reverse, pressing the **FORWARD** button repeatedly cycles through three speeds of fast forward.
-  **Slow:** Slows down the speed of the program.
-  **Instant Replay:** Instantly plays the last eight seconds of the program again.
-  **Advance:** (a) If you are watching live TV, catches up to the current time. (b) When you are fast forwarding in a recorded program, instantly jumps ahead to the next tick mark (short white line on the status bar). When you are rewinding, jumps back to the previous tick mark. (c) If you are watching a recorded program, jumps to the end of the recording. Press again to jump to the beginning of the recording.

▶▶ Status Bar

When you press PLAY, PAUSE, FORWARD or BACK, a status bar appears on the lower part of your screen. In live TV, the status bar represents one hour (notice the white tick marks every 15 minutes). In recorded programs, the bar shows the program's length. The green portion of the bar represents the part of the program saved by the DVR. The DVR automatically saves up to 30 minutes of live TV. You can rewind and fast forward through the saved portions of a program.

In live TV, the right edge of the green segment represents the current time. A white vertical line shows where you are in the saved portion of the program. If the white line is anywhere back in the green segment, you are behind live TV. When you're behind live TV, you can press the ADVANCE button (⏩) to catch up.



4

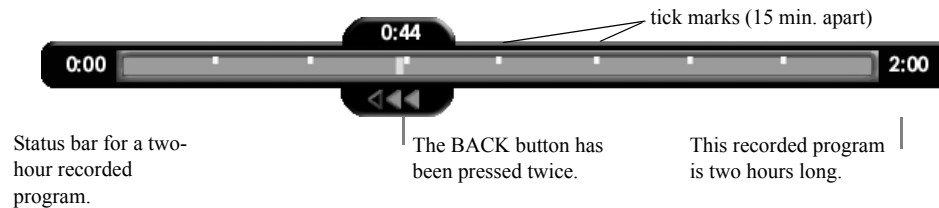
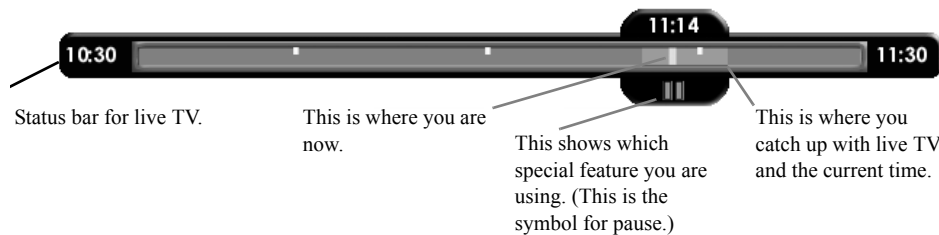

The EXIT button hides the status bar, guide, channel banner, and anything else that is not part of the program.

►► Music Channels



Some DIRECTV® channels feature continuous music. You can tune to a music channel just as you would any other channel. You cannot record music channels or use special features—such as pause or rewind—on a music channel.

Music Channels have a special music banner that displays for five minutes when you first tune to them. You can bring the music banner back to the screen by pressing the RIGHT arrow, or INFO. The music banner is updated continuously as information comes in from the satellite. It may not always have complete information.

►► Standby

You can put your DIRECTV DVR in standby mode by selecting “Standby” from DIRECTV Central, or by pressing the STANDBY button on the front of your DVR.

- If you temporarily turned off Parental Controls, standby mode enables them again.
- The lights on the front of the DVR go out and it shows a black screen on your TV. It responds to only a few buttons on the remote control.
- The DVR will not tune to previously ordered pay per view programs unless you have them scheduled to be recorded.
- Programs that are recording or scheduled to record will record in standby mode.

To turn off standby mode, press the DIRECTV button on your remote control.

Standby mode and local channels. If you have an antenna or receive cable service in addition to DIRECTV® programming, you may have it connected to your DVR’s RF input. In this case, standby mode lets you watch channels received by your antenna or cable. However, you won’t be able to use the DVR service or other features with those channels. (For example, you cannot make Season Pass recordings for those programs.)

Finding and Recording Programs

Recording Programs: The Basics	58
Finding Programs to Record	68
I Already Know What I Want to Record	69
I Know What I Like	73
Help Me Find New Programs	79

►► Recording Programs: The Basics

All programs saved on your DVR are listed in the Now Playing List (no more searching through unlabeled videotapes!). To go to the Now Playing List, press the DIRECTV button on your remote control twice, or press the LIST button. As soon as a recording begins, it appears at the top of the list. You can watch any title in the Now Playing List, even one that is still being recorded.

► **Now Playing List**

To watch a program in the Now Playing List, highlight it and press PLAY. If you have watched part of the program already, it resumes from the point you stopped watching. To delete a program in the list, highlight it and press CLEAR. Press SELECT to confirm.

Selecting a program in the Now Playing List displays a Program Information screen where you can:

- **Play (or Resume playing).**
- **Save until....** To change the date when the program may be deleted, press the DOWN arrow until the date is highlighted, then press the RIGHT or LEFT arrows until the date you want appears. Press SELECT to return to the Program Information screen.
- **Stop Recording.**
- **Delete Now.**
- **Save to VCR.** Saves a program from the Now Playing List to a videotape (see page 66).



► **Getting a Season Pass**

A Season Pass records every episode of a series that airs on a certain channel—even if the day or time slot changes! It is totally automatic and really easy to set up. Just select a program (from the DIRECTV Advanced Program Guide™, for example) and choose “Get a Season Pass.” Season Pass recordings have the following characteristics:

- **No duplicates within 28 days.** If you watch or delete a particular episode or showing, it will not be recorded automatically again for 28 days. This prevents the Now Playing List from filling up with shows you probably don’t want. If you want to record duplicates, select the program on the Season Pass screen, then choose “Change recording options,” highlight “Show Type options,” and select “All (with duplicates).”
- **Parental Controls.** If Parental Controls are on when you schedule a Season Pass, the DVR checks its current program information to see if any upcoming program violates a Parental Control. If a program does, the DVR requires the current password to continue. See page 90.
- **Keep at Most=5.** By default, five episodes of the program are kept in the Now Playing List. You can change this setting. See page 60.
- **Resolving conflicts.** The DVR service resolves scheduling conflicts by comparing recording priorities. You can change priorities using the Season Pass Manager. See page 60.

Repeating Recordings. In addition to being characteristics of the Season Pass, the above also apply to two other types of recordings that repeat automatically:

- A *manual repeat recording* records on a specific channel at a specific time (much like the recordings you would set up with a VCR). See page 72.
- An *auto-recording WishList* records all the programs a WishList finds. See page 78.



If some Season Pass programs are not recording, you may need to change their priority with the Season Pass Manager. See page 60.



An exception to the 28-day, no-duplicates feature may occur if the program wasn’t watched but was deleted from the Now Playing List to make room for another recording you requested. Another reason a duplicate recording might be made is if the program information describes the program incorrectly.



Managing Your Season Pass recordings. With Dual Tuner, you can record two programs at the same time. Conflicts will occur only if you try to schedule a third recording that overlaps the other two. By default, the oldest Season Pass has the greatest priority. If some Season Pass programs are not recording, you may need to change their priority with the Season Pass Manager. To do this, go to DIRECTV Central, then select “Pick Programs to Record,” then “Season Pass Manager.”

To change the priority order:

1. Use the UP/DOWN arrow buttons to highlight one of your repeating recordings.
2. Press the RIGHT arrow to highlight the arrows to the right of the title.
3. Use the UP/DOWN arrows to move the selected title up or down in the list.

Resolving Conflicts. If a conflict occurs when you’re setting up a new repeating recording, you’ll be shown which programs are involved. You’ll also be given options to resolve the conflict:

- Record the program you just requested and cancel one of the already scheduled programs. This gives the new repeating recording the highest priority.
- Record only those programs that do not conflict with others previously scheduled to record. This gives the new repeating recording the lowest priority.

▶ Setting Recording Options

When you set up a recording, you can set various recording options. You can change them later by selecting the program in the To Do List or Season Pass Manager.

The Program Information screen that appears when you select a program includes choices to “Record this episode” and “Get a Season Pass.” When one of these recording actions is

highlighted, “Options” appears to its right. To see the current Recording Options, use the arrow buttons to highlight “Options,” then press SELECT.

To set Recording Options:

1. On the Recording Options screen, use the UP/DOWN arrows to highlight an option.
2. Press the RIGHT and LEFT arrows to change the setting.
3. When you are done, press SELECT or highlight “Record with these options.”
4. Press SELECT again to schedule the recording with the new options.

To cancel your changes, press the LEFT arrow.

Recording Options include:

- **Keep At Most.** (Only available for a repeating recording.) This option sets the maximum number of programs to save as part of the series. The default is five. This is useful for news programs for which you only want the most recent episode, or children’s programs for which you may want to keep several episodes but do not want to fill up the Now Playing List.
- **Show Type.** (Only available for a repeating recording.) You can select “Repeats & first run,” “First run only,” which records only new episodes, and “All (with duplicates).”
- **Keep Until.** (Only available for a repeating recording.) If you change this setting from “Space needed” (the default) to “Until I delete,” programs are saved until you delete them. If your DVR fills up with programs marked “Until I delete,” it will stop making new recordings until you delete some old programs.



- **Keep At Least.** (Only available for an individual recording.) This option sets the minimum amount of time for the DVR to keep a recording. The default setting is two days, except for pay per view events, which default to “Save until I delete.”

The next two items on the list are collectively known as the Overtime Scheduler™.

- **Start Recording.** Use this setting to start recording a program before its scheduled beginning. For example, to catch the first joke of a comedy series, you can set the Season Pass to start recording one minute early. The default is “On-time,” but you can choose to start recording 1, 2, 3, 4, 5 or 10 minutes before the program is scheduled to begin.
- **Stop Recording.** Use this setting to stop recording a program after its scheduled end time. For example, you may want to continue recording for a while after the scheduled end of a sports event, should it go into overtime. The default setting is “On-time,” but you can stop recording 1, 2, 5, 15, or 30 minutes, or 1, 1.5 or 3 hours after a program is scheduled to end.

Tip. You can sometimes resolve recording conflicts by changing the Stop Recording or Start Recording options. For example, if you set a program to start recording one minute early, it may conflict with a recording of the program before it. To resolve the conflict, simply change the Start Recording option back to “On-time.”

► Program Information Screen

In the Program Guide, highlighting a program title (that is not currently playing) and pressing SELECT displays some information about the program. You can also choose “Season Pass & other options” to get to the Program Information screen. The Program Information screen includes a brief description of the selected program. It also shows the program’s start time, channel, duration, ratings, advisories, and other attributes. For more details on a given program, press INFO at a Program Information screen. The Program Details screen appears.

If you have given a program a Thumb rating, Thumbs Up/Thumbs Down icons appear at the top of the Program Information screen. You can change the rating here by pressing THUMBS UP or THUMBS DOWN.

Ratings and Advisories. The Program Information screen shows ratings and advisories for the selected program. For a description of movie and television ratings, and of television advisories, see “Parental Controls” on page 90. A movie may also have advisories, regardless of whether it has a rating. The following movie advisory codes may appear in parentheses after the description:

AC: Adult Content	SC: Sexual Content	N: Nudity
AL: Adult Language	MV: Mild Violence	BN: Brief Nudity
GL: Graphic Language	GV: Graphic Violence	RP: Rape

Other attributes. Other attributes may appear in parentheses after the description of a program. These may include genre information or technical notes such as CC (for closed captioning), letterbox (which means the program is broadcast in letterbox, a wide-screen format) and Dolby Digital.



Actions you can take. The lower part of the Program Information screen shows actions you can take. Available actions vary depending on what kind of program is selected and whether the program is already recorded or is scheduled to record.

- For actions you can take on programs that are scheduled to record (programs in the To Do List), see page 65.
- For actions you can take on pay per view programs, see page 39.
- For actions you can take on recorded programs (programs in the Now Playing List), see page 58.

If the program is not yet scheduled to record, you can take these actions:

- **Record this program/episode.** Schedules a recording of the current program. You can also use the RIGHT arrow to highlight “Options,” then press SELECT to change Recording Options.
- **Get a Season Pass.** (Only available if the program is part of a series.) Select this to get a Season Pass for the program.
- **View upcoming episodes/showings.** Displays a list of upcoming episodes/showings of the program on all channels.
- **Don’t do anything.** Returns to the previous screen without making changes. LEFT arrow also selects “Don’t do anything.”

► **Reviewing the To Do List**

The To Do List shows all scheduled recordings. To view it, go to DIRECTV Central, then Pick Programs to Record, then To Do List. After setting up a recording, you can confirm that it is scheduled on the To Do List. Individual recordings have a single checkmark (✓) to the left of the program title. Season Pass and manual repeat recordings have a double checkmark (✓✓), and WishList searches (see page 73) have a star (★). Season Pass recordings with no upcoming episodes to record appear at the bottom of the list.

Select a recording from the To Do List. Then you can:

- **Change recording options.** Highlight Record as planned, then press the right arrow and select “Options” to see Recording Options. If the program is part of a Season Pass, changing Recording Options from the To Do List only makes changes for a single episode, not for the Season Pass. Choose Cancel/edit the Season Pass to make changes for all episodes.
- **View upcoming episodes/showings.** Displays a list of upcoming episodes/showings of the selected program. Programs scheduled to record have a checkmark, double checkmark, or a star. Select a program to see the Program Information screen.
- **Cancel this recording or Cancel only this episode/showing.** Cancel a single recording or a single episode from a Season Pass.
- **Cancel/edit the Season Pass.** From this screen you can cancel the Season Pass, view upcoming programs, or change recording options for the whole Season Pass.
- **Cancel/edit manual repeat recording.** Lets you cancel or change recording options for a manual repeat recording.



Canceling the recording of a pay per view event does not automatically cancel the purchase. You must cancel the purchase on the Purchases screen, described on page 85.



► **View Recording History**

This is an advanced feature for those who really want all the details. It is available as a selection in the To Do List, and displays a history of programs that have been deleted or have not recorded. The history also lists recordings that were requested but will not be recorded, as well as the reason for not making the recording.

Selecting a program displays a screen that explains how and when the program was removed from the Now Playing List or To Do List. If the program is scheduled for the future, you can select “More recording options” on this screen to reschedule it.

► **Saving Programs to a VCR**

If you have a VCR, you can save a program from the Now Playing List to a videotape. You will not be able to watch live TV or recordings while saving.

Most of the buttons on your remote that control live TV work as usual during Save to VCR. Keep in mind that the VCR will record the video exactly as it plays. This means you can fast forward through the boring parts! (It also means the VCR will record the channel banner, status bar, and any icons that appear if you press buttons on the remote.)

Preparing for Save to VCR:

1. Set up your VCR. Be sure you have connected your DVR's video and audio to the VCR's video and audio. See the *Start Here* poster that came with your DVR.
2. Be sure your VCR is set to record input from your DIRECTV® DVR, not some other video source. (See your VCR's instructions for how to set the input.)
3. Make sure you have a videotape in the VCR.

Using Save to VCR:

1. Go to the Now Playing List, highlight the show you want to save, then press SELECT.
2. Using the arrow buttons, highlight “Save to VCR,” then press SELECT.
3. Select “Start saving from the beginning.”
4. A title screen appears for ten seconds. When you see it, press your VCR’s record button.
5. When the program is over, press stop on your VCR.

Stopping Save to VCR:

Going to live TV interrupts (or stops) the transfer. You can resume saving later.

1. Press a button (for example, the DIRECTV button) that would interrupt Save to VCR. The videotape icon appears.
2. While the icon is visible, press the same button again.
3. A confirmation screen appears. On the confirmation screen, choose either “Stop saving for now. Resume later” or “Cancel saving to VCR.”
4. Press stop on your VCR.

To resume saving the program:

1. Go to the Now Playing List, select the program, and then choose “Save to VCR.”
2. Choose “Save from the paused location.” A countdown screen appears.

To ensure that your VCR has time to begin recording, press record on your VCR before the countdown gets to “1.”

►► Finding Programs to Record

Find shows to record. The DVR service allows you to quickly set up recordings for the shows you already know you love. It also helps you search for fun, exciting new programs that match your interests, hobbies, favorite stars and genres. Which of the following statements fits your mood today?

<i>I already know what I want to record (page 69)</i>	Describes Search by Title and Record by Time or Channel.
<i>I know what I like (page 73)</i>	Describes Wishlist searches.
<i>Help me find new programs (page 79)</i>	Describes TiVo Suggestions and Showcases

Set up recordings. After finding a program, it's easy to schedule a recording. You can schedule one recording or choose one of these options to set up a repeating recording:

- Season Pass recordings record every episode of a program on a specified channel (see page 59).
- An auto-recording WishList records every program a WishList finds (see page 78).
- A manual recording records a chosen time and channel and can be set to repeat once each week, every day, or just on weekdays or weekends (see page 72).

Programs you have scheduled to be recorded appear in the To Do List (see page 65). To watch recorded programs, select them in the Now Playing List (see page 58).

►► I Already Know What I Want to Record

The following options are useful if you already know the title of the program you want to record:

- Search by Title
- Record by Time or Channel
- Manually Record by Time or Channel

► **Search by Title**

Use Search by Title if you are looking for a specific program and you know its name.

1. After selecting Search by Title, you have the option of limiting your search to a category of programs (such as movies or sports). This is useful if you just want to browse through a list of upcoming programs in a given category and/or subcategory. If you do not want to choose a category, select “All Programs.”
2. The next screen lets you type the title of the program you are looking for. Use the arrow buttons on the remote to move around the keypad. Press SELECT on each letter of your program title. As you select letters, a list of programs appears to the right of the keypad. Continue entering letters until you see your program in the list. (For a quick review of how to enter titles using the onscreen keypad, see “Tour 3: Find and Record Your Favorite Programs” on page 38.)
3. Use the RIGHT arrow to move the highlight to the program list.
4. When you find a program you want to record, highlight it and press SELECT to bring up the Program Information screen.





► **Record by Time/Channel**

Record by Time/Channel offers you three choices: Browse by Time, Browse by Channel, and Manually Record Time/Channel. These options are described separately in the next few pages.

► **Browse by Time**

Browse by Time lets you browse all programs on a particular day and time. For example, you can browse all the movies on Saturday night. With Browse by Time, you can filter the list to see only programs on your Favorite Channels or only programs in a particular category. To learn how to program your list of Favorite Channels, see page 50. To find a program:

1. Use the arrow buttons to highlight a category (for example, “Movies”) to narrow the list of programs. Then press SELECT.
2. Select a subcategory (for example, “Comedy”), then press SELECT.
3. Use the UP and DOWN arrows to select the day of programming that you want to see. Press the RIGHT arrow to move the highlight to the time column.
4. Use the UP and DOWN arrows to select a time. The time will advance in half-hour increments.
5. Press SELECT to bring up the list of programs without leaving the time selector (or press the RIGHT arrow to bring up the list of programs and move to the list at the same time). When you find a program you want to record, highlight it and press SELECT to bring up the Program Information screen.

► **Browse by Channel**

Browse by Channel lets you browse through programs on a particular channel. You can start with all channels or just your favorites. To browse by channel:

1. Highlight and select either “All Channels,” which includes all the channels you receive, or “Favorite Channels,” which includes just the channels you have selected as your favorites.
2. Use the UP and DOWN arrows to select the date you want to browse. Press the RIGHT arrow to move the highlight to the channel column.
3. Use the UP and DOWN arrows to select a channel. (You can also use the numbers on the remote to type in a channel, then press ENTER/LAST.)
4. Press SELECT to bring up the list of programs without leaving the channel selector (or press the RIGHT arrow to bring up the list of programs and move to the list at the same time).
5. When you find a program you want to record, highlight it and press SELECT to bring up the Program Information screen. Then you can view upcoming episodes, set up a Season Pass, or record an individual showing.

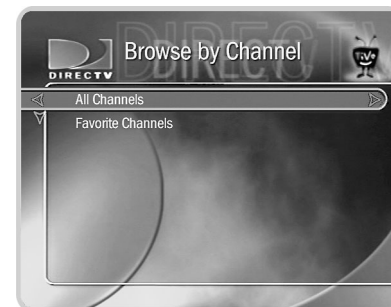



Record by Time or Channel is

useful for times when you want to record only a portion of a program, for example, the opening monologue of a talk show.



► Manually Record by Time or Channel

Manually Record Time/Channel lets you schedule a recording on a specific channel at a specific time, just as you would with a VCR. You can also create a manual repeat recording for every week, every day, or every weekday. To create a manual recording:

1. To choose the Recording Type, use the UP and DOWN arrows to select “One Time,” or “Repeating.” Then press the RIGHT arrow.
2. To choose the day(s) for the recording, use the UP and DOWN arrows to change the current selection. If you chose “Repeating,” you can also choose to repeat the recording on a specified day of the week, on every weekday (select “Every M-F”) or every day (select “Every Day”).
3. To choose a channel, use the UP and DOWN arrows or enter a number from the number keypad. Press the RIGHT arrow.
4. To set the hour, minute, and am/pm for the start and stop time, use UP/DOWN arrows to change the current selection. Press the RIGHT arrow to move to the next step, LEFT arrow to move back.
5. To schedule the recording, press SELECT. A confirmation screen appears. The recording will be named with a “best guess” based on program guide listings for that time and channel. This will help you find your program later in the To Do List or Now Playing List.



►► I Know What I Like

If you know what you like, WishList searches are great! They allow you to find and automatically record shows that match your interests, tastes, passions, and whims. You can search for future programs with your favorite actor or director by creating an Actor or Director WishList. You can also create a Category Only WishList to find programs tailored to particular categories. The Keyword WishList and the Title WishList allow you to search for specific words or phrases in program descriptions and titles.

► Try a WishList!

For example, you could create a Category Only WishList for the category “Movies” and subcategory “Action/Adventure.” You could then use it occasionally to look at a list of all action/adventure movies airing in the next two weeks. The list would be constantly updated by program guide data.

You could search for something more specific by creating an Actor WishList for Elizabeth Myer, and then include the category “Movies,” and subcategory “Romance.” This WishList would only find romance movies with Elizabeth Myer.

Using a Keyword WishList, you can look for something very specific. For example, the Keyword WishList “*LIGHTNING*” with category “Football” would find Lightning football (but not baseball) games for you.

Here’s another example: You could make a Keyword WishList to find a 1986 remake of a movie called *The Fright*, starring Chris Fields. The keyword entry would look like this: “*CHRIS FIELDS*” *FRIGHT*. Not only does this WishList find a specific program—it finds the specific version! (You could also find this movie by making a Keyword

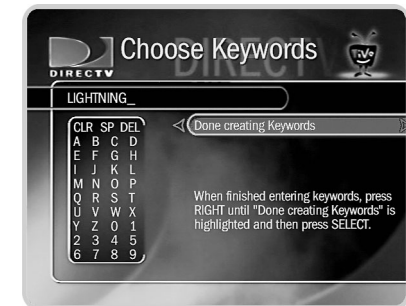



 **If you set up an auto-recording WishList for sports, consider using the Overtime Scheduler™ (a recording option described on see page 62) to make sure you don't miss the most exciting part of the game!**

WishList for the movie's title and year. In that case, the keyword entry might look like this: “*THE FRIGHT*” 1986.)

After you make a WishList, you can periodically view what it finds by selecting “View all upcoming WishList programs,” or selecting an individual WishList, then selecting “View upcoming programs.” Then you can schedule recordings for the programs or episodes you want. (See page 78 for more details.)

Can a WishList Do More Than Search?

You can set a WishList to auto-record, and it will record every program the WishList finds. For example, with the Elizabeth Myer Actor WishList, you would automatically collect Elizabeth Myer romance movies in the Now Playing List.

Some WishList searches are better suited to browsing than to auto-recording. For example, you could create a Category Only WishList for the category “Documentary.” This WishList would find every upcoming documentary. You could then occasionally browse the WishList and choose the upcoming documentaries you want to record.

The more specific a WishList is, the better suited it is to auto-recording. For example, an auto-recording Keyword WishList with the keywords *SNICKS* and *RABBITS*, and category “Sports/Basketball” would only record basketball games with both of these teams—a great way to ensure that you enjoy this season's rivalry. (For more on auto-recording a WishList, see page 78.)

► Creating a WishList

From Search Using WishLists, select “Create new WishList.” Next, select the type of WishList: Actor, Director, Category Only, Keyword, or Title. For most WishList searches, you use the keypad on the next screen to spell out what you’re looking for.

As the last step, you’ll then be able to select a category and subcategory to narrow your search. For example, if you want movies with Elizabeth Myer, but not documentaries or talk shows, select “Movies.” To search every category, select “Don’t specify a category.”

Category Only WishList: Use the UP and DOWN buttons to highlight a category, then press SELECT. A subcategories list appears. Highlight a subcategory, then press SELECT. To search all subcategories, you can also select “Don’t specify a subcategory.”

Actor or Director WishList Searches: Spell the person’s last name first by using the arrow keys to move the selection box around the keypad and pressing SELECT to enter the highlighted letter. As you select letters, a list of names appears to the right of the keypad.



If you see the person’s name, press the arrow buttons to highlight the name you want and press SELECT. To search for a name that is not on the list, enter the name in the format: *LAST NAME, FIRST NAME*. You must match the spelling of the name exactly, and you must use a comma (in the keypad under the letter *W*). If an actor or director is not listed, and none of their programs are in the Program Guide, try a Keyword WishList.

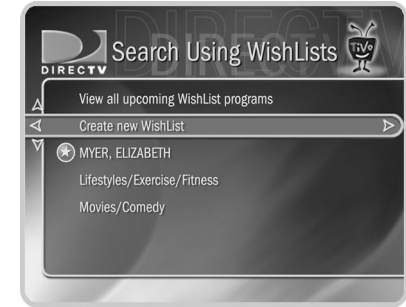

Keyword or Title WishList Searches: You can create a Keyword WishList with one keyword or with several. If you enter more than one keyword, the WishList only finds programs that match *all* of your keywords. With Keyword WishList searches, the DVR service checks for your keywords in the program or episode title, description, actor, director, year, and category information. Title WishList searches work very similarly, but the DVR service searches only program and episode titles.

Spell your keyword(s) by using the arrow buttons to move around, then pressing SELECT to enter highlighted letters on the keypad. You can enter as many characters as will fit on the screen. When you have finished, use the RIGHT arrow to highlight “Done creating keywords,” then press SELECT.



Using * in WishList Searches. To search for similar words in Keyword and Title WishList searches, use the asterisk (*) as a special symbol that replaces the endings of words. For example, the keyword *HELI** would find shows containing “helicopter,” “heliport,” “helium,” as well as the movie “Helicopter Cops.” To enter an asterisk, press the SLOW (⏪) button as you are spelling out your keyword or title.

The asterisk can be helpful when you’re looking for a range of similar words, as in the example above, or if you’re just not sure how something is spelled. Pop quiz: is it “irresistible” or “irresistable?” Use the keyword *IRRESIST** and don’t worry about it! Two things to note about using the asterisk:

- It can only be used at a word’s end; it cannot be used to omit letters at the beginning or in the middle of a word. (For example, *HELI*ER* or **COPTER* would not work.)
- Be as specific as possible. For example, do not use keywords like *TH**. There will not be enough room to show all the results of a keyword that is too general.



► **Tips for entering keywords**

- To specify an exact phrase in a Keyword or Title WishList, surround a set of words with quotation marks (to enter quotation marks, press PAUSE (⏸)). For example, the keyword *BILL SIMON* might also turn up a documentary about Simon Branden with a director whose name is Bill. Use “*BILL SIMON*” to be certain you find programs that only feature Bill Simon.
- If you enter more than one keyword in Keyword or Title WishList searches, only programs that match all of your keywords (for example, “*CHRIS FIELDS*” *FRIGHT*) are found.
- If you want to include an exact phrase and additional keywords, there should be a space between the final quotation mark and the beginning of the next word. You can place a space character by selecting SP on the grid of letters or by pressing FORWARD (▶▶).
- Replace hyphens (-), slashes (/) and periods (.) with spaces. For example, you would use the keyword phrase *10 10* to search for the title “*10/10*.” For an Actor WishList for Sarah Mills-Jones, use *MILLS JONES, SARAH*. You can place a space character by selecting SP on the grid of letters or by pressing FORWARD (▶▶).
- Any other marks, such as apostrophes (’) and ampersands (&), are ignored. For example, you would use the keyword phrase *6 O’CLOCK NEWS* to search for the title “*6 O’Clock News*.” (Note that commas (,) are also ignored, except in actor and director WishList searches, where they are essential.)
- For dollar signs (\$) substitute the letter S. For example, to find “*\$50,000 Chance*,” use *S50000*. (In Search by Title, skip the dollar signs to find these titles.)



Title WishList searches are an excellent way to search for a program that is not on in the next couple of weeks, but that you would want to record if it ever came on. For example, if you want to record “The Shadow Country” the next time it airs, create a Title WishList for the phrase “Shadow Country.” Set the WishList to auto-record. If you want to make sure the program will record, give the WishList a high priority with the Season Pass Manager. (See page 59.) The next time “The Shadow Country” comes on, your WishList will record it.



If you see too many programs when you select “View upcoming programs,” the WishList you are using is probably better suited for searching and browsing than for auto-recording.

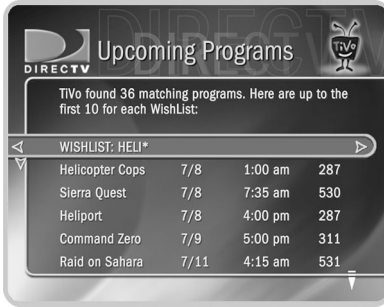
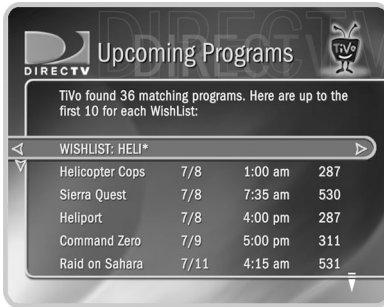

If you create an auto-recording

WishList with the category

“Sports,” previews of pay per view programs may be recorded and appear on your Now Playing List. These will be marked as partial recordings on the Program Information screen. You will not be charged for such recordings.

► **Browsing, Recording, and Editing WishList Searches**

To browse all WishList items: Select “View all upcoming WishList programs.” This displays a list of up to 10 programs from each of your WishList searches—and up to 200 programs total. The list is divided to display programs found by each WishList. To record a program, select its title, then choose “Record this episode” on the Program Information screen.

To browse an individual WishList: Highlight the WishList and press SELECT. Select “View upcoming programs,” which searches through current program information and creates a list of up to 200 unique upcoming programs that match this WishList. This list displays the first airing of an episode or program.

To see all the showings of upcoming episodes (up to two weeks into the future), select the title of the program in the “Upcoming programs” list generated by your WishList. Then select “View upcoming episodes.” A comprehensive list appears, including several episodes with showings on different channels and different time slots. The Program Information screen also includes an option for recording a particular program.

Auto-recording WishList searches. When you create a WishList or select it, you can choose to “Auto-record WishList programs.” This means every program the WishList finds will be automatically recorded.

Auto-recording WishList searches themselves and their upcoming recordings are marked with a star (★). To be sure that all your WishList programs are recorded, give the WishList a high priority in the Season Pass Manager. See page 59 for details.

To edit a WishList. Select the WishList, then select “Edit WishList.” You can change your WishList—for example, to correct a misspelling or to add a category.

▶▶ Help Me Find New Programs

The DVR service provides special features that help you sift through upcoming programs to find shows you'd like:

TiVo Suggestions these show up in the Now Playing List if they're recorded.

Showcases go to DIRECTV Central, then select this option.

▶ TiVo Suggestions

Your DVR tries to make sure there is always something interesting on for you to watch. How does it know what you will like? It tries to predict your preferences based on Thumb ratings you have given other programs, and on the single THUMBS UP given to programs you choose to record. You can check TiVo Suggestions occasionally to see what's new. The list of programs is ranked, so shows you are more likely to enjoy are near the top. To view the list, go to DIRECTV Central, then select "Pick Programs to Record," then "TiVo Suggestions."

TiVo Suggestions improve over time as you record and rate programs. The more you use the Thumb buttons, the better TiVo Suggestions become. You can use the Thumb buttons while you are browsing TiVo Suggestions or whenever you are:

- Watching live TV or browsing the guide.
- Viewing a Program Information screen (for example, to schedule a recording).
- Looking through a Showcase such as TiVolution Magazine.



5



Only programs airing on channels in the Channels You Receive list can be recorded as TiVo Suggestions.



Your personal TV preferences are just that: personal. DIRECTV privacy policies are available on the web at DIRECTV.com.

When there is empty space in the Now Playing List, the DVR service may record TiVo Suggestions for you. Suggestions are marked in the Now Playing List with a TiVo icon (). The DVR never deletes a program you requested to make room for a suggestion. Instead, suggestions are deleted to make room for recordings you schedule. A preference that prevents TiVo Suggestions from recording automatically is described on page 97. TiVo Suggestions that have been recorded once will not record again for at least 28 days.

► **Showcases**

Looking for the biggest shows on TV? Showcases are your shortcut to the most exciting events and the best movies. Whether you're looking for a hit comedy or want to get the most from your subscription to the premium channels, Showcases offer you a quick, interactive way to get what you want. You'll always find something fun and unusual in the TiVolution Magazine Showcase. Showcases are updated several times weekly during the DVR's daily phone call.

To explore Showcases and schedule recordings:

1. Press the DIRECTV button to see DIRECTV Central.
2. Select Showcases. A collection of Showcases appears.
3. All of the showcases may not fit on the screen. You can use the CHAN DOWN button to see showcases that are not visible at first. Each showcase is represented by a graphic. A white box appears around the highlighted showcase and a graphic displays at the top of the screen. Use the navigation buttons, RIGHT, LEFT, UP and DOWN, to highlight the showcase you want and then press SELECT. A list of themes in that Showcase appears.

4. Use the CHAN DOWN button to see themes that are not visible at first. When you highlight a theme, a short description of it appears at the top of the screen. Select a theme. A list of programs appears.
5. You can use the CHAN DOWN button to see programs that are not visible at first. When you highlight a program, a short description of it appears at the top of the screen. Select a program to see its Program Information screen. If the channel that carries the program is included in your “Channels you Receive” list, you can schedule a recording from the Program Information screen.

Messages and Setup

Messages from DIRECTV	84
Purchases	85
My Preferences	89
Recorder & Phone Setup	99
System Information	106
Troubleshooting	107
Restart or Reset System	108

►► Messages from DIRECTV



From time to time DIRECTV may send you messages about updates to your service and other important notices. These messages are important, useful and easy to get to—we made them that way because we really want you to read them. When you receive a new message, a message icon () appears on the channel banner and in DIRECTV Central.

To read a message:

1. From DIRECTV Central, select “Messages and Setup.”
2. Select “Messages.”
3. Select the message you want to read.

Use the CHAN DOWN button to see text that does not fit on the screen. When you are finished reading a message, select “Done” or “Delete Message.”

Selecting the message icon in the channel banner will take you to your list of messages. The message list will display No Messages if there are no messages to read.

►► Purchases

To see the Purchases screen, first press the DIRECTV Button, then Messages and Setup, then select “Purchases.” The Purchases screen displays a list of all pay per view programs you have purchased, along with their date and time. Each program in the list is also marked either “Upcoming,” “Purchased,” “Canceled,” or “Unviewed.”

- **Upcoming.** These programs are scheduled to be purchased but have not aired yet. You have not yet been charged for them. You can cancel upcoming purchases by selecting them. The Purchase Info screen, described below, will appear.
- **Purchased.** These programs have been viewed. You were charged for them.
- **Canceled.** Purchase of these programs was canceled before the programs aired. You were not charged for them.
- **Unviewed.** These programs were scheduled to be purchased but were not viewed and not recorded. You were not charged for them.

Purchase Info. The Purchase Info screen shows a selected pay per view event’s date, time, channel and purchase price. You can cancel upcoming purchases on this screen. Canceling a scheduled pay per view recording in another place—for example, the To Do List—does not cancel the purchase. You must cancel the purchase from the Purchases screen. To see Purchase Info, highlight a program and press SELECT.

To cancel an upcoming purchase:

- On the Purchases screen, highlight an upcoming purchase and press SELECT. The Purchase Info screen appears.
- Select “Cancel this purchase.” A confirmation screen appears.

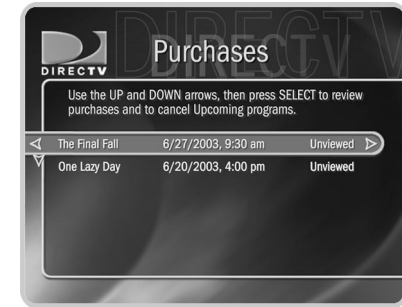



If a pay per view program exceeds spending or rating limits you have set with Parental Controls, a password will be required to purchase it.

- Press SELECT. The purchase is canceled. You return to the Purchases screen. If you cancel a purchase that is scheduled to record, the recording is also canceled.

► **Pay Per View**

Your DIRECTV® DVR makes buying and recording pay per view events a snap. You can order them when they are promoted on live TV, or during a search for programs. You can order them to watch, or to be recorded. And the whole transaction can be handled using your remote control.

The Purchases screen keeps a record of all your pay per view purchases. You can also go to the Purchases screen to cancel purchases of pay per view events that have not yet aired.

Ordering from live TV. While watching live TV, you may see a promotion for a pay per view event, including instructions to press SELECT for ordering information. If you press SELECT, you will see the Program Information screen for pay per view.

If the promotion happens when you are not caught up to live TV, a small message that says “Press Select” and “Next Showing” will appear. If you press SELECT, you will see the Program Information screen for pay per view. If you don’t want the program, you can press EXIT to remove the message.

Program Information for Pay Per View. When you order a pay per view event from live TV, or select a pay per view event in Pick Programs to Record or the Program Guide, you see the Program Information screen for pay per view. Options on the Program Information screen vary, depending on whether the event selected is currently showing, is already scheduled to record, or is currently available to be purchased through the DVR. Though some events have dedicated channels that allow ordering more than 24 hours in advance,

you usually cannot use the DVR to purchase a pay per view event more than 24 hours before the event airs. Recorded pay per view programs are marked “Save Until I Delete” (the green icon) by default. That way your recorded movies are saved until you manually delete them from the Now Playing screen.

- **Purchase & record info.** If the DVR does not have purchase information (such as the price of the pay per view event) immediately available, it can do a short check for it. If the DVR gets purchase information, the event will become available to purchase and record. To check for purchase information the DVR must briefly tune to a special channel. If you are recording a program, checking for pricing information this way may create a short skip in the recording. The skip is usually less than two seconds but may be up to ten seconds long. The DVR provides a confirmation screen so you can avoid such a skip by choosing not to check for purchase information.

If the DVR finds purchase information by tuning away, the pay per view screen will be refreshed with the new information and you will have the option to purchase the program. If the DVR cannot find purchase information, you will be informed that purchase information is not available.

- **Buy and record.** When you select this option, the pay per view event is purchased and a recording of it is scheduled on the To Do List. A verification screen appears describing any scheduling conflicts. If you verify that you want to buy and record the event, a second screen confirms the purchase. You can select “Options,” to the right of “Buy and record,” to change Recording Options for the pay per view event.

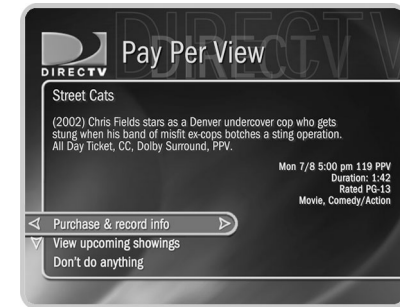



- **Buy; don't record.** When you select this option, you purchase the pay per view event. A verification screen appears with a description of any scheduling conflicts.
- **View upcoming showings.** Press SELECT to display a list of upcoming showings for the program. Highlighting one of these showings and pressing SELECT displays the Program Information screen for that showing. LEFT arrow from the list returns to the previous screen.
- **Watch Now.** Available if the program has been purchased and is currently playing.
- **Review/cancel purchases.** The pay per view screen includes this option if you have already purchased a program. Selecting “Review/cancel purchases” displays the **Purchases** screen, where you can cancel any purchases you have not yet watched or recorded.
- **Record as planned.** Available if you already scheduled the program to record. Selecting this leaves the pay per view screen without making any changes.
- **Cancel this recording.** Available if the program has been purchased and is being recorded. Selecting this option cancels the recording. (Because the DVR began recording the program, you will still be charged for the purchase.)
- **Continue recording.** Available if the program is already recording. Selecting this option leaves the pay per view screen without making any changes.

►► My Preferences

To see My Preferences, press the DIRECTV button, and then select “Messages & Setup” and then “My Preferences.” My Preferences are your personal preferences—you change them to make the DVR work more to your liking.

► Customize Channels

What are channel lists for? Features such as Search by Title and Search Using WishLists only look at programs available on channels selected in the Channels You Receive list. Your DVR also uses lists of channels to decide which channels the List Guide displays and which channels to search in Browse by Channel.

There are two selections available in Customize Channels:

Channels You Receive. The Channels You Receive list starts with all DIRECTV® channels. It can be customized to include only channels you actually subscribe to and to reflect your viewing preferences (for example: if you never watch a channel and don’t plan to set up any recordings on it, or let the DVR service search for programs on it, you can de-select it here).

Favorites. The Favorites list is for channels you watch frequently. Include only a few channels in this list, so that you can quickly look at what’s coming up on them.

To set up a custom channel list:

1. Select the Channels You Receive or Favorite Channels list. A check mark appears to the left of channels that are part of the selected list.
2. To remove or add a channel, highlight it and press SELECT. (You can speed through the list with the CHAN UP/DOWN. To go directly to a specific channel, press the number buttons, then press ENTER/LAST.)





The large version of the channel banner has a shortcut to Parental Controls. Press INFO, then press the DOWN arrow to highlight the lock icon, then press SELECT.

Your changes are saved automatically. Press the LEFT or the RIGHT arrow to return to the Customize Channels screen.

► **Parental Controls**

Parental Controls allow you to set limits on movie and television ratings and to lock specific channels so that a password is required to view them. If you try to watch a program in the Now Playing List that violates a Parental Control, you will also be asked for the password. In addition, when Parental Controls are on, you must enter a password to delete a program that violates a Parental Control.

The padlock icon shows the current state of Parental Controls:



Off. No password or controls set. Padlock appears unlocked and dark.



On. Password and controls set. Padlock appears locked and bright.



Temporarily off. Parental controls are set, but a password has been entered to temporarily turn them off. The padlock appears unlocked and bright.

While Parental Controls are on, you can watch a locked program or channel by pressing SELECT, then entering the Parental Controls password. This temporarily turns off Parental Controls.

To turn on Parental Controls and define a password (🔒)

1. Select “Turn on Parental Controls.”
2. Use the number buttons on the remote control to enter a four-digit password.
3. Enter the same password again for confirmation.

To temporarily turn off Parental Controls (🔓)

- Enter the password to watch a program or channel—Parental Controls become temporarily turned off, or
- Select “Temporarily turn off Parental Controls” on the Parental Controls screen, then enter your password.

When Parental Controls are temporarily turned off, any program or channel can be viewed, but the correct password is still required to change Parental Controls settings.

To re-enable Parental Controls (🔒)

- On the Parental Controls screen, select “Re-enable Parental Controls,” or
- Put the DVR in Standby, then take it out of Standby. To do this, press the DIRECTV button on the remote control, then select “Standby,” or press the Standby button on the DVR.

Auto Re-lock Option

When Parental Controls are temporarily turned off, they re-lock automatically after four hours if you don’t use your remote. Parental Controls won’t re-lock in the middle of a show. By default, the Auto Re-lock option is on.

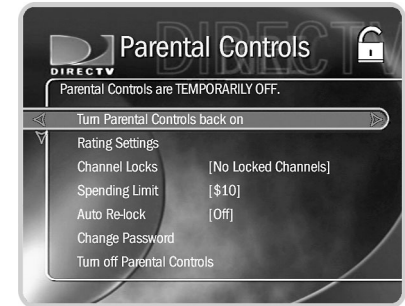

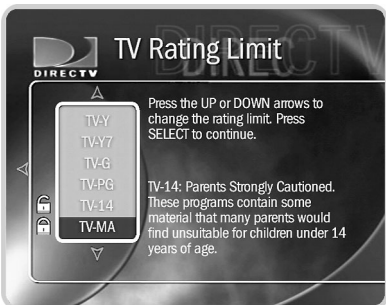
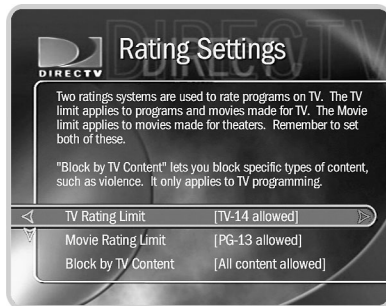
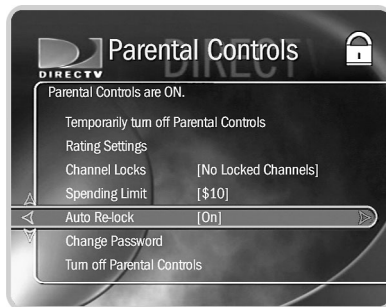

To turn off Auto Re-lock:

Go to Messages & Setup, then My Preferences, then Parental Controls. Press the DOWN arrow to highlight “Auto Re-lock,” then press SELECT. Enter your password, then highlight and select “Auto Re-lock off.”

Rating Settings for TV and Movies (🔒)

Movies that are originally meant for release to theaters have a different rating system from programs that are made for TV. You can use Parental Controls to set limits for both rating systems. There is also a rating system for TV content that allows you to set limits for specific types of content that may be objectionable—such as sexual content or violence.

To set Rating Limits for TV and Movies:

1. From Parental Controls, select “Rating Settings,” then enter the password and press SELECT.
2. Select the kind of limit you want to change: TV or Movies.
3. The next screen contains a box listing all potential ratings. Ratings shaded in green are not locked; those in red are locked. Use the UP and DOWN arrows to move the red shading and adjust which ratings are locked. Your changes are saved automatically. When you are done, press the RIGHT or LEFT arrow to return to Parental Controls.

If a movie has no rating information, it is treated as if it has the highest movie rating, ‘X.’ If you require a password for X-rated movies, then movies without rating information also require a password. If a television program has no rating information, it is treated as if it has the lowest TV rating, ‘TV-Y’; a password is only required to view it if you set Parental Controls to require a password for programs rated ‘TV-Y.’

To set Rating Limits for Specific TV Content:

1. From Parental Controls, select “Rating Settings,” then enter the password and press SELECT.
2. Select Block by TV Content.
3. A list of categories appears on the next screen. Select a category (for example, V-Violence).
4. A box containing all the possible ratings appears. Ratings in green are not locked; ratings in red are locked. (Ratings in gray do not apply to the category. For example, a TV-Y program would not have *V-Violence* content so there is nothing to block.)



Use the UP and DOWN arrows to adjust which ratings are locked or unlocked. The display to the right of the box will change to tell you exactly what ratings level you are allowing. Your changes are saved automatically. To return to the Parental Controls screen, press SELECT or the RIGHT arrow

gray = does not apply to the category
green = not locked
red = locked

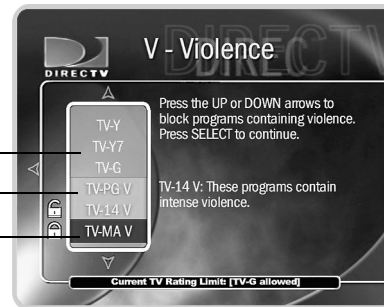

 Broadcasters are not required to provide ratings for specific types of content. Parental Controls only blocks programs that do not have specific content ratings if you choose to block their age-based ratings (described on the previous page). For example, if you choose to block the “TV-14” rating, a password is required to view all programs rated “TV-14,” whether or not those programs include additional ratings for specific content.

► **Motion Picture Association of America ratings for movies**

G: General Audiences. Most parents would find this material suitable for all ages.

PG: Parental Guidance Suggested. Parents may find portions of this material unsuitable for younger children.

PG-13: Parents Strongly Cautioned. This material contains portions many parents would find unsuitable for children under 13 years of age.

► **Ratings for television movies and programs (including content ratings):**

TV-Y. All children. This program is designed to be appropriate for all children. Whether animated or live action, the themes and elements in this program are specifically designed for a very young audience, including children from ages 2-6. This program is not expected to frighten younger children.

TV-Y7. Directed to older children. This program is designed for children age 7 and above. Themes and elements in this program may include mild fantasy or comedic violence, or may frighten children under the age of 7. Programs where fantasy violence that may be more intense or more combative than other programs in the TV-Y7 category are designated TV-Y7-FV.

TV-G. General audience. Most parents would find this program appropriate for all ages. Although this rating does not signify a program designed specifically for children, most parents may let younger children watch this program unattended. It contains little or no violence, sexual dialogue, or situations; and no strong language.

R: Restricted. This material is specifically designed to be viewed by adults and therefore may be unsuitable for children under 17.

NC-17: Adult Content. This material contains intense, disturbing, or graphically portrayed themes or content that are not suitable for viewing by children under 17.

X: Explicit Sexual Content. This material contains explicit sexual content and is intended to be viewed by adults ONLY.

NR: (Not Rated). This program has not been rated.

TV-PG. Parental guidance suggested. This program contains material that parents may find unsuitable for younger children. Many parents may want to watch it with their younger children. The theme itself may call for parental guidance and/or the program contains one or more of the following: moderate violence (V), some sexual situations (S), infrequent coarse language (L), or some suggestive dialogue (D).

TV-14. Parents strongly cautioned. This program contains some material that parents would find unsuitable for children under 14 years of age. Parents are strongly urged to exercise greater care in monitoring this program and are cautioned against letting children under the age of 14 watch unattended. This program contains one or more of the following: intense violence (V), intense sexual situations (S), strong coarse language (L), or intensely suggestive dialogue (D).

TV-MA. Mature audiences only. This program is specifically designed to be viewed by adults and therefore may be unsuitable for children under 17. This program contains one or more of the following: graphic violence (V), explicit sexual activity (S), or crude, indecent language (L).

Channel Lock for Live TV (🔒)

You can lock individual channels so that a password is required to view any program on those channels. To lock or unlock channels:

1. From the Parental Controls screen, select “Channel Lock,” and then enter the password.
2. A channel list appears with a padlock icon to the left of any locked channels. Highlight a channel and press SELECT to add or remove a padlock icon. Use CHAN UP/DOWN to move through the list quickly. You can highlight a specific channel by entering its channel number with the number buttons on the remote.
3. When you are done, press the RIGHT or LEFT arrow to return to Parental Controls. Your changes are saved automatically.

Spending limit. You can limit the amount that may be spent on a single pay per view event. When Parental Controls are on, a password is required to purchase any event that exceeds the limit. To set the spending limit:

1. Select “Spending Limit.” A password screen appears.
2. Enter the password and press SELECT. If Parental Controls are off, you are asked to create a new password and they are turned on.
3. The Spending Limit screen appears. Use the number buttons on the remote control to enter a spending limit.
4. Press SELECT to save your changes and return to Parental Controls, or press LEFT arrow to discard your changes and return to Parental Controls.



If you set the spending limit to zero (“0”), pay per view programs

cannot be purchased without entering the correct password.





When you turn Parental Controls off, you don't need to know a password to turn them back on. You may prefer to temporarily turn off Parental Controls, so that another person in your household does not choose a new password.



To change the Password (🔒)

To change the password for Parental Controls, Parental Controls must be on.

1. Select Change Password on the Parental Controls screen.
2. Enter a new password.
3. Re-enter the new password.

To turn off Parental Controls (🔓)

1. Select “Turn off Parental Controls.”
2. Enter the password and press SELECT.

When Parental Controls are turned off, the password is deleted and anyone can view any programs or watch any channels.

▶ **Channel Banner**

Normally, when you change channels, a channel banner displays for a few seconds. If you want the channel banner to disappear quickly, select “Clear banner quickly.”

▶ **Audio Options**

Dolby® Digital. This sets your DVR's default to automatically record and output Dolby® Digital audio whenever a program includes it. You should do this if you have the digital output of your DVR connected to an audio/visual system equipped with Dolby® Digital decoding. If you are watching a program with Dolby® Digital audio, you will not hear the DVR's sound effects. You can change to Dolby® Digital audio for individual programs that include it by selecting the Dolby® Digital icon (🔊) in the channel banner.

Sound Effects Volume. Allows you to change the volume or turn off your DVR's sound effects (the tones played when you press buttons on the remote control). The default setting is Medium. Sounds effects are not currently available from the DVR's digital audio output.

Audio Language. This sets your DVR's default to automatically play the sound track in the language chosen, if that language is available. If the language you choose here is not available, the program's default language is used. When programs include alternate audio tracks (alternate audio usually provides the sound track in a different language), you can change the audio track for individual programs by selecting the Alternate Audio icon () in the channel banner.

▶ **TiVo Suggestions**

This screen lets you turn automatic recording of TiVo Suggestions on or off. When automatic recording is on, TiVo Suggestions may be recorded onto free disk space. Programs you have recorded or scheduled to record will never be deleted to make room for TiVo Suggestions. If space is needed to save programs you have scheduled to record, TiVo Suggestions are the first things to be deleted. When you set up your DVR, automatic recording of TiVo Suggestions is on.

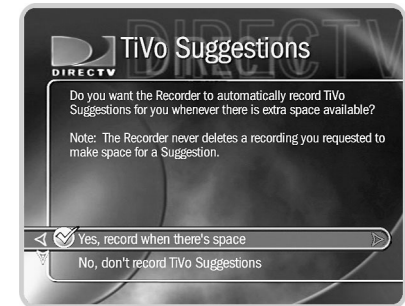



Standard Screen



Wide Screen

► **TV Aspect Ratio**

This screen lets you choose one of two settings, the default Standard Screen—4:3 or Wide Screen—16:9. If you have a normal television, you should leave this setting at the default. If you have a wide screen set, select “Wide Screen—16:9.” Doing this allows programs transmitted in a wide screen format to fill the wider screen. If you are unsure of the correct setting, leave it at the default Standard Screen—4:3. If this is the wrong setting for your television, programs in wide screen format may appear 'squashed' horizontally—people would seem very tall and thin.

Movies are generally made in a wider format than standard television images. Movie images on television deal with the difference in one of the following three ways:

Standard or “Pan-and-Scan”. The edges of the movie are carefully edited to make it fit the television format. This format is unaffected by the TV Aspect Ratio setting.

Letterbox. The full width of the movie image is displayed. On standard TVs, this leaves a black margin on the top and bottom of the image. Some wide screen TVs can eliminate the margins and make Letterbox fill the screen. (See the owner's manual for your wide screen TV.) This format is unaffected by the TV Aspect Ratio setting.

Anamorphic. This method allows the DVR to choose how to display the image. If TV Aspect Ratio is set to Wide Screen, the DVR displays a wide screen image. If TV Aspect Ratio is set to Standard, the DVR displays a Letterbox image.

▶▶ Recorder & Phone Setup

Options under Recorder & Phone Setup affect the basic functioning of the DVR. Most of these settings were established before or during Guided Setup, and you may not ever need to change them.

▶ Satellite Dish Setup

If you have a loss of signal and wish to diagnose the problem, or you need to re-point your satellite dish antenna, or if you add additional equipment, you can select “Satellite Dish Setup” to reconfigure your satellite dish antenna setup.

Test Signal Strength. This screen shows approximate pointing information for your satellite dish antenna. You can also use this screen to check the strength of the signal received from each transponder on a selected satellite dish antenna. It shows you the signal strength from individual transponders one at a time. To be sure you receive all of your channels, you should check signal strength on all transponders.

A transponder is a piece of radio equipment on a satellite. The DIRECTV transponders receive information from DIRECTV and rebroadcast it to your satellite dish antenna. Different channels are rebroadcast by different transponders, and different satellites have different numbers of transponders.

Note: You can check signal strength while you adjust the pointing of your satellite dish antenna. The signal strength meter on this screen provides audio feedback—a tone that becomes higher pitched as the signal gets stronger. You may be able to turn the volume on your TV up so you can hear the tone while you adjust the position of your satellite dish antenna. Alternatively, you might have someone watching the signal strength meter and

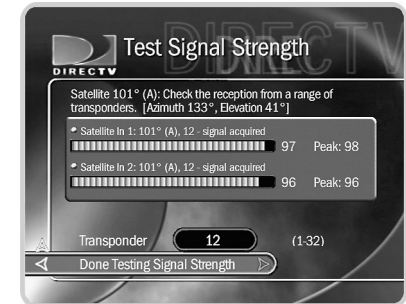



then reporting through a cell phone or walkie-talkie to the person who is adjusting the satellite dish antenna.

When you first come to this screen, it shows signal strength for the transponder that carries the current channel. If you are having trouble with a specific channel, tune to that channel, then come to this screen to check the signal for that transponder.

- To change the transponder, use the UP arrow to highlight the transponder number. Press the RIGHT or LEFT arrow to change the transponder number. It is best if each transponder has a signal strength above 70.

If you have an Oval, 2 or 3 satellite dish antenna, you can check the signal strength from transponders on each satellite.

- To change the selected satellite, press the UP arrow until the satellite number is highlighted. Press the RIGHT or LEFT arrow to change the satellite.
- Press the DOWN arrow to highlight the transponder number, then press the LEFT or the RIGHT arrow to check the signal on different transponders.

If your signal strength is low, see “Satellite Signal Troubleshooting,” on see page 28.

Repeat Satellite Dish Guided Setup. After selecting this, you need to enter a safety code (press THUMBS DOWN three times, then press ENTER). This option lets you repeat Satellite Dish Guided Setup. For more information, see page 25.

Reset Satellite Information. Only use this feature if directed to do so by a professional installer or a DIRECTV customer care representative. In most cases, you can use Satellite Dish Guided Setup, rather than this option.

► **Phone Connection**

The DVR makes a daily call to communicate with the DIRECTV® DVR with TiVo® service, so a telephone line should be connected to it. The DVR occasionally makes a brief phone call to get updates to the DVR service, Showcases, and pay per view functionality. You can see details of the daily call on the Phone Connection screen, including the time of the last successful call and last call attempt, and the status of the last call.

Below the call details are the menu options Change Dialing Options, Make Test Call and Make Daily Call Now. If your area code has changed and/or you need to choose a different dial-in number, you will need to change your dialing options. You should make a test call after any changes to your dialing options.

Make Test Call. After selecting Make Test Call, the Test Phone Connection screen will display and the call will start automatically. When the call has finished, press SELECT to continue.

Make Daily Call Now. Under normal use, you do not need to make the daily call manually. However, for troubleshooting or other unusual circumstances, you may wish to use this option.

After you start the call, the status indicator reads “Starting Up.” The status will update as it cycles through various states. You can watch TV and use your DVR while the call is in progress. The DVR typically uses the phone for less than ten minutes during a daily call.

Change Dialing Options. Selecting this displays the Phone Dialing Options screen, from which you can change the following settings:



Your DVR should NOT be used with any digital PBX phone system. For more information, see page 3.



► **Phone Dialing Options**

Set Dial-In Number. The number your DVR is currently using to call the DVR service is displayed on the Phone Dialing Options screen. To change it:

1. Select Set Dial-In Number on the Phone Dialing Options screen.
2. Use the number keypad on the remote to set the area code, then press SELECT. If you changed the area code, or if the DVR has not made a daily call in the last twenty-four hours, the Update Numbers screen appears and the DVR calls the DVR service. After the phone call, press SELECT. The Dial-In Number screen appears.
3. Use the UP/DOWN arrow to choose one of the numbers on the Dial-In Number screen. The DVR will use this number to access the DVR service. After you press SELECT, the Dialing Format screen will appear.
 - If your area code has no access numbers, you can press the LEFT arrow to return to the Area Code screen and try to enter a nearby area code.
 - If none of the numbers listed on the Dial-In Number screen are in your local calling area, select “None of the Above.” The No Local Numbers screen will appear.
4. The No Local Numbers screen appears if you selected None of the above on the Dial-In Numbers screen. Select Request 800 number authorization on the No Local Numbers screen. This temporarily authorizes you to use the toll-free number and submits a request to DIRECTV Customer Care. It is the current policy of DIRECTV to allow you to use the toll-free number if there are no local numbers available. DIRECTV will research available dial-in numbers at your location and send a message to your DVR authorizing you to use the toll-free number, or suggesting a local alternative.

- The Dialing Format screen appears after you have chosen a dial-in number. You should use this screen to tell the DVR which dialing format to use. For example, should the dial-in number be preceded by your area code and should a “1” precede the area code? In some areas, even local numbers must be dialed using the area code. Press SELECT to return to the Phone Dialing Options screen.
- To test your new dial-in number, select “Test Phone Connection Now.” The Test Phone Connection screen appears and a test phone call begins. When the call completes, you should see the message “Test Succeeded!” Press SELECT to return to Phone Dialing Options. (If the phone call does not succeed, see troubleshooting on page 132.)

Set Dial Prefix. You can use this screen to specify a prefix if the DVR needs to use one to reach an outside line (for example, the DVR may need to dial “9” before it dials out). Use the number keys on the remote control to enter the prefix. Press the PAUSE button after you have entered the prefix. This will insert a comma, which will create a two second pause after the prefix is dialed. If you make a mistake, use the BACK button to backspace.

Set Call Waiting Prefix. If you have call waiting, you may choose to disable it while the DVR is making a call, so that the DVR’s phone call is not interrupted. If you do not disable it, the DVR may drop the call and allow the second call to ring through, depending on your phone system. The DVR will then try its call again later. The most common code that phone companies use to disable call waiting is *70. Sometimes a comma is needed (*,70). Check with your phone company to find out how to disable call waiting in your area. If you make a mistake, use the BACK button to backspace.

Set Tone/Pulse. If your phone system uses pulse dialing, rather than tone dialing, you can change the setting here.

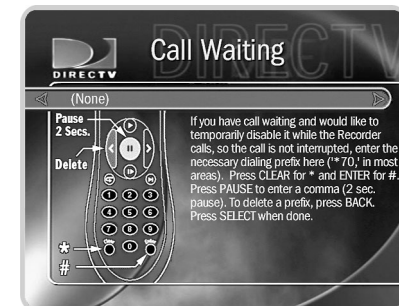
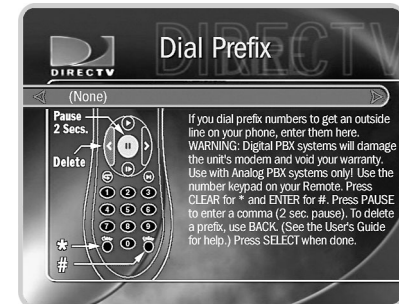
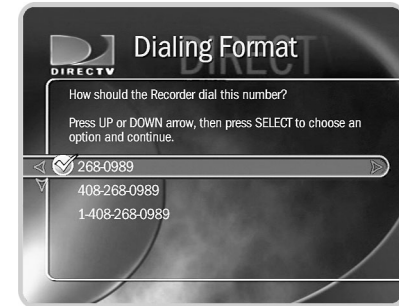

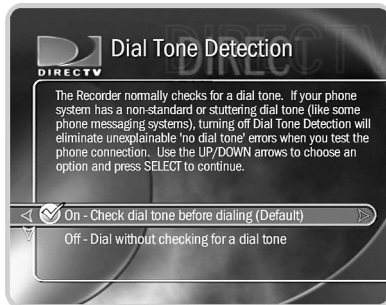
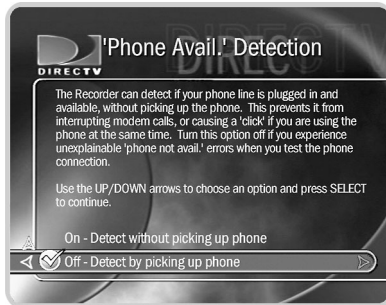

With Dial Tone Detection and

'Phone Avail.' Detection both

turned off, if you happen to be talking on the phone when the DVR tries to call you will hear the modem dial and try to communicate with the server.

Set 'Phone Avail.' Detection. Off by default. When Set 'Phone Avail.' Detection is on, the DVR determines whether the phone line is in use by detecting voltage on the line. This allows it to avoid disrupting a call in progress (such as another modem call). However, if you are experiencing "Failed, Line unavailable" errors, or if the DVR is not making daily calls, you may have a low-voltage phone system that the DVR cannot detect. In this case, try selecting "Off" for 'Phone Avail.' Detection.

With 'Phone Avail.' Detection turned off, the DVR must pick up the line to check for a dial tone. If you are on the phone when the DVR tries to call, you may hear a click on the line. If you have another modem call in progress (on your computer or other device), that call may be disrupted if the DVR attempts to make a service call.

If you turn off 'Phone Avail.' Detection and you have a standard dial-tone, turn on Dial Tone Detection (described next).

Set Dial Tone Detection. On by default. When this is on, the DVR checks for a dial tone before dialing. If this is on and you have a non-standard dial tone (for example, an analog PBX system), or a stuttering dial tone (as some voice messaging systems have), the DVR will be unable to detect the dial tone and will not make its daily call.

► **Phone Troubleshooting**

This screen provides a list of hints for troubleshooting problems with your phone connection. To view all of the hints, use the CHAN DOWN button to scroll down the page; use the CHAN UP button to scroll up the page.

► **Remote Control Setup**

You can set your remote control to control power, muting and volume on your TV or A/V Receiver. See page 111 for instructions.

▶ **Time Zone/Daylight Savings**

DIRECTV sets the time on your DVR to be accurate at your billing address. If you temporarily move the DVR to a new location, you can change the time zone here. After changing the time zone, you can change the Daylight Savings setting.

▶ **Replace Access Card**

If you need to replace your DIRECTV access card, follow the on-screen instructions.

▶ **System Test**

System Test runs tests on the DVR's signal, tuning, access card and phone connection, then shows whether or not the test succeeded. You can also see the ID Number for your DIRECTV access card on this screen. The tests begin as soon as the screen appears.

If the tests succeed, press SELECT to return to Recorder & Phone Setup. If the tests fail, press SELECT to retry them or LEFT arrow to return to Recorder & Phone Setup.

- If the Signal or Tuning test failed, you need to troubleshoot the signal from your satellite dish antenna. For hints, see "Satellite Signal Troubleshooting" on page 28.
- If the Access Card test failed, check your Access Card. The proper side of the Access Card should be inserted firmly into the slot on the front of the DVR. If you have inserted the correct card firmly, and the Access Card test is still failing, see the Customer Care information on the back of this manual.
- If the phone connection test fails, see page 132 in the Troubleshooting chapter.

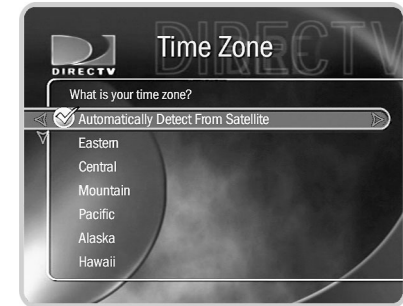



►► System Information

This is where you can find the DVR's serial number, Receiver ID number, the manufacturer and model number, the software version, information about recent service calls, and the DVR's storage capacity. You'll need some of this information if you call Customer Care for support. You can use CHAN UP/DOWN to see all of the screen.



**Remember, you can use CHAN UP/
DOWN to see text below or above**

what is displaying on the current screen.

▶▶ Troubleshooting

▶ **Parental Controls Troubleshooting**

This screen provides a brief description of how to use Parental Controls. Use CHAN UP/DOWN to see all of the text on the screen.

▶ **Phone Troubleshooting**

This screen provides tips to help you troubleshoot problems with your phone connection. Use CHAN UP/DOWN to see all of the text on the screen.

▶ **Satellite Troubleshooting**

This screen provides basic information about connections to your satellite dish antenna and dual tuner, and has some troubleshooting steps. Use CHAN UP/DOWN to see all of the text on the screen.



If you do not have the remote control, you can also press buttons on the front of the DVR to enter the safety code. Press the INFO button three times and then press DOWN.

▶▶ Restart or Reset System

You may need to restart the DVR as a routine troubleshooting step. These options erase information and restore original factory settings. Selecting a reset option brings you to a warning screen. To continue press THUMBS DOWN three times, then press ENTER.

Restart the DVR. Shuts down the DVR and starts it up again. It will not affect recorded programs, Season Pass items, WishList searches, or TiVo Suggestions.

Reset Thumb Ratings and Suggestions. Removes all Thumb ratings and deletes the list of TiVo Suggestions under Pick Programs to Record. It does not delete TiVo Suggestions that have been recorded and are in the Now Playing List.

Clear Program Data and To Do List. Clears all program information, cancels all Season Pass items and everything in the To Do List, and removes all Thumb ratings. It does not delete programs in the Now Playing List. The DVR acquires new program guide data from the Satellite, over the next one to two days. Completing this process may take over an hour.

Clear and delete everything. Clears all Season Pass items, WishList searches, Thumb ratings, TiVo Suggestions and Now Playing List recordings, program information, and the To Do List and setup information, including the Channels You Receive and Favorite Channels lists. It also clears the current password and resets Parental Controls to the factory specified default. Completing this process may take over an hour.

Programming the Remote Control

Introduction	110
Instructions: TV Power, Volume, and TV Input	111
Resetting the Programmable Buttons	114
Setting a Remote Address	115

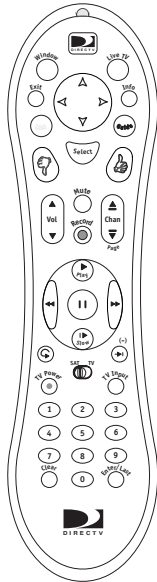

The **TV INPUT** button can control which video signal—or “input”—your TV displays. TV inputs can include the signal from a VCR, DVD player, or a camcorder.

►► Introduction

For information about the individual buttons on the remote control, please refer to the inside front cover of this guide. Before programming the remote control, you must first insert the batteries and complete Guided Setup.

► Using the Remote with a TV and A/V Stereo System

The DIRECTV remote will already work with your DVR. You can also set it up to control your TV and A/V stereo system. For example, you can set up the remote to:

- **Control TV power, volume, mute, and input settings:** Complete the instructions on page 111 using the first column in each of the tables (TV power, volume, and mute). Then repeat the instructions using the second column (TV input).
- **Control TV and A/V receiver power; A/V stereo system volume and mute:** Complete the instructions on page 111 using the first column in each of the tables. Then repeat the instructions using the third column (A/V receiver power, volume, and mute). In this case, the TV POWER button turns on/off both the TV and the A/V receiver. The VOL and MUTE buttons control only the A/V receiver.
- **Control TV power and A/V stereo system volume and mute:** Complete the instructions on page 111 using the first column in each of the tables. Then repeat the instructions using the fourth column (A/V receiver volume and mute). The VOL and MUTE buttons control only the A/V receiver.

The SAT/TV switch sets the remote control to send channel changing signals to either the DVR (SAT) or the television (TV). If you program the remote to control the volume on the A/V receiver, it continues to control the A/V receiver’s volume when you change the SAT/TV switch to TV.

▶▶ Instructions: TV Power, Volume, and TV Input

1. Go to the Remote Control Setup screen.

Press the DIRECTV button; then select “Messages & Setup,” then Recorder & Phone Setup, then Remote Control Setup. Choose which device/functions you want to control:

TO CONTROL:	TV power, volume, and mute	TV input	A/V system power, volume, and mute	A/V system volume and mute only
CHOOSE:	Remote Control–TV (power, volume, mute)	Remote Control–TV (TV Input)	Remote Control–A/V Stereo Receiver	Remote Control–A/V Stereo Receiver

2. Select the brand of your device.

Using the UP/DOWN arrows, highlight the brand of the device you wish to control, then press SELECT. (If you have been using a universal TV remote control, select your TV or A/V receiver’s brand, not the brand of the universal remote.) Next you’ll see a screen with four-digit codes.

3. Prepare the remote control.

Point the remote away from your DVR. Refer to the table below and determine which two buttons to press to prepare the remote. Press and hold the buttons simultaneously for about 5 seconds (until the red light at the end of the remote control lights up and stays on when you release the buttons).

TO CONTROL:	TV power, volume, and mute	TV input	A/V system power, volume, and mute	A/V system volume and mute only
PRESS THE:	TV PWR and DIRECTV buttons	TV Input and DIRECTV buttons	TV PWR and DIRECTV buttons	MUTE and DIRECTV buttons

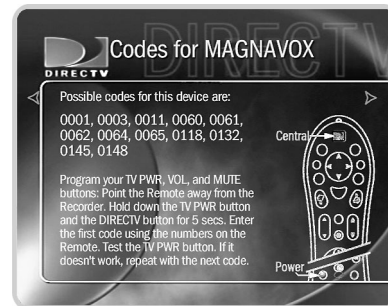
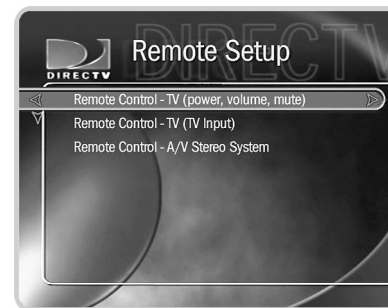

4. **Enter a code.** Use the number buttons on the remote control to enter a four-digit code (starting with the first code in the list on the screen). After you press the fourth digit of the code, the red light on the end of the remote control should flash. If it doesn't, try the next code.
5. **Test the code.** Point the remote towards the TV and test the button (refer to the table):

<i>TO TEST THE:</i>	TV power, volume, and mute	TV input	A/V system power, volume, and mute	A/V system volume and mute
<i>PRESS THE:</i>	TV PWR button	TV Input button	TV PWR buttons	MUTE button

If pressing the button works (e.g., turns the TV or A/V stereo system off, or changes the TV input), the code is correct. If it does not work, repeat steps 3 and 4 using the next code on the list. If none of the codes works, perform a code search (see below).

► **Performing a Code Search**

If none of the codes listed allows you to control your device, a code search may detect the correct code. Performing a code search can take up to 20 minutes.

1. **Prepare the remote control.** Point the remote away from your DVR.

Refer to the table below and determine which two buttons to press to prepare the remote. Press and hold the buttons simultaneously for about 5 seconds (until the red light at the end of the remote lights up and stays on when you release the buttons).

<i>TO CONTROL:</i>	TV power, volume, and mute	TV input	A/V system power, volume, and mute	A/V system volume and mute only
<i>PRESS THE:</i>	TV PWR and DIRECTV buttons	TV Input and DIRECTV buttons	TV PWR and DIRECTV buttons	MUTE and DIRECTV buttons

2. **Enter the search code.** Refer to the table below and use the number keys on your remote control to enter the appropriate code.

TO TEST:	TV power, volume, and muting	TV input	A/V system power, volume, and mute	A/V system volume and mute only
ENTER:	0999	0999	1999	1999

After you press the fourth digit of the code, the red light on the end of the remote control will flash twice, then remain on.

3. **Test the remote control.** Point the remote control at the TV or A/V stereo system. Press CHAN UP. Did the TV or A/V stereo system turn off? If not, wait two or three seconds, then press CHAN UP again. Continue doing this until the TV or A/V stereo system responds.

When the TV or A/V receiver does turn off, press ENTER to select the current code. The red light at the end of the remote control will flash three times to indicate that the remote control is properly coded to control your device.

When the red light on the end of the remote control turns off, you have reached the end of the available codes.

Unfortunately, due to the great variety of TVs and A/V stereo systems, some makes and models are not compatible with your DVR's remote control. If you reach the end of the available codes without finding a code that works with your device, you will need to use your TV or A/V stereo system's remote to turn it on and off, and control the volume.

▶▶ Resetting the Programmable Buttons

If you make a mistake, or are having difficulty, you can reset the programmable buttons. Once you do so, all the buttons on the remote will return to the unprogrammed state of a new remote.

1. **Prepare the remote control.** Point the remote away from your DVR. Press and hold the TV PWR button and DIRECTV button simultaneously until the red light at the end of the remote control comes on, remains steady, then stays on when you release the buttons.
2. **Press THUMBS DOWN three times, then press ENTER.** (To cancel, press CLEAR before you press ENTER.)

▶▶ Setting a Remote Address

If you have two DVRs in the same house, you may want to assign a remote address to each remote control. This will prevent the crossing of signals between one DVR's remote and the other's.

1. If the DVRs are both in the same room, cover the area around the shiny, dark plastic window on the front of one DVR. You can use a dark piece of cloth, a magazine, or anything thick and opaque. This prevents the DVR from receiving signals.
2. Point the remote control at the DVR for which you want to set the remote address. Press the DIRECTV button, and select "Messages & Setup." Select "System Information," and press the DOWN arrow until you see "Remote Address."
3. Point the remote control away from the DVRs, and cover the front end of the remote with your hand. Press and hold the PAUSE and DIRECTV buttons until the red light at the end of the remote control comes on and stays on when you release them.
4. Point the remote control at the DVR for which you want to set the remote address, and press the number "1." Press the RIGHT arrow. On the screen, the "Remote Address" changes to 1. Exit System Information by pressing the DIRECTV button.
5. Repeat steps 1-4 on the second DVR and its remote control, pressing the number 2 for the second remote address.

The remote controls are now set to send signals exclusively to the DVR for which they are addressed. You may want to label the remote controls so that you remember which DVR they control. Addresses 1 to 9 are unique. 0 is a universal address, meaning it will try to control any DVR that "hears" its signal.



If you do not exit system information before you go to step 5, you may transmit information to the original DVR and overwrite the first address you entered.

Troubleshooting

Contacting Customer Care	118
Questions About Installation	119
Questions About Live TV (Including Satellite Signal)	120
Questions About Pick Programs to Record	125
Questions About Parental Controls	131
Questions About the DVR's Phone Calls	132
Questions About Audio	135
Questions About Pay Per View	136
Questions About the Remote Control	138
Questions About the DIRECTV® DVR with TiVo® Service	139

▶▶ Contacting Customer Care

For questions about your RCA DVR

After checking the Troubleshooting chapter of this guide, you can call RCA Customer Support at 580-634-0151 if you need help:

- Connecting your Receiver to your TV and other A/V equipment.
- With Guided Setup or daily phone calls that are failing.
- With a Receiver that does not function properly even after restarting it.
- With other questions regarding the DVR or remote control.

For questions about your DIRECTV® programming or DVR service

After checking troubleshooting, call DIRECTV Customer Care at 1-800-DIRECTV (1-800-347-3288) if you need help:

- Activating or using a feature of the DIRECTV® programming or DVR service.
- Understanding an on-screen message regarding your service.
- When you call either RCA or DIRECTV, you will need the 12 digit number on your DIRECTV access card and the make, model, serial number, and 12 digit Receiver ID number of your DVR, found on a label on the back of the DVR and on the System Information screen. (Press the DIRECTV button, then select “Messages & Setup” then “System Information.”)



Websites

You will find all of the most up to date information about DIRECTV’s products and services at the DIRECTV website, DIRECTV.com. The RCA website at RCA.com has links to a wide variety of products and information.

►► Questions About Installation

I do not see the Welcome screen

If you do not see the Welcome screen, you may need to change channels or change the video source your TV uses:

- If you used coaxial RF cable  to connect your DVR to the TV, make sure you're viewing the same channel (3 or 4) that you selected using the switch on the back of your DVR.
- If you used Composite Video and L/R Audio cables  to connect your DVR, make sure your TV is displaying the appropriate video source. You may need to use the "INPUT," "SOURCE," or "TV/VIDEO" button on your TV or TV's remote control to change video sources. If you are having trouble changing the video source, refer to the instructions that came with your TV.
- If you did not connect the DVR directly to the TV but are instead passing the signal through your VCR, make sure your VCR is displaying the appropriate video source. You may need to use the "Input," or "Source" button on your VCR or VCR's remote control. Also, some VCRs only pass the signal through when they are turned either on or off. If you are having trouble displaying the correct video source, refer to the instructions that came with your VCR.
- If you are still having trouble, double-check your connections.

►► Questions About Live TV (Including Satellite Signal)

During Satellite Guided Setup, the screen got stuck on the Satellite Info screen.

- Press the DIRECTV button, then select “Messages and Setup,” then select “Recorder & Phone Setup,” then “Satellite Dish Setup,” then choose “Reset Satellite Information.” The screen will warn you not to proceed unless you have been instructed to do so by a customer care representative. In this instance, it is safe to proceed past this screen without consulting Customer Care.

How do I see what’s on TV on every channel?

- From live TV, press the GUIDE button on the remote to display the program guide. You can use the CHAN UP/DOWN button to scroll the list a page at a time and use the FORWARD and BACK buttons to go forward and back in time.

How long can I pause live TV?

- You can pause for up to 30 minutes on each tuner. After 30 minutes, the video will start playing again, 30 minutes behind “real time.”

How far back can I rewind live TV?

- The length of time you can rewind depends on how long you have been watching the same channel. The recording starts over each time you change the channel, so if you have just changed the channel, you won't be able to rewind very far (the green area on the Status Bar will be very small). You can store up to 30 minutes of the current channel. If you have been watching the same channel for more than 30 minutes, you can rewind for up to 30 minutes. The same is true for two channels with dual tuner.

Can I watch TV while a program is recording?

- Yes, you can watch what is recording as it is being recorded. You can also watch any program stored in the Now Playing List while another program is being recorded. If you have dual tuner, you can record one program while watching another. See page 3 for information about Dual Tuner.
- If you have an antenna or cable signal in addition to DIRECTV® service, you can watch programs carried by that signal—without the DVR service—while your DVR is in standby mode. For more information, see page 55.

After changing the channel, how do I rewind to what I was watching before?

- You can only rewind Live TV to the point where you last changed the channel. When you change the channel, you skip ahead to the current time on the new channel, and start recording fresh, on that channel. If you are behind live TV and watching something you still want to see, you shouldn't change the channel. If you have Dual Tuner, however, you can “surf” two channels and the DVR saves up to 30 minutes of each channel's programming.

How do I know if I'm watching live or delayed TV?

- Press PLAY to bring up the Status Bar. If the white line is at the right edge of the green area, you are caught up to live TV. If the white line has green to the right of it, you are watching delayed TV. To catch up to live TV, press the ADVANCE (⏭) button.

When does the DVR get program data?

- Your DVR downloads program guide data throughout the day from your satellite connection. It takes a day or two for the DVR to get all of its guide data (up to 14 days) after you have completed Guided Setup.

How do I get back to the last channel I was watching?

- When watching live TV, typing a channel number jumps the DVR to that channel. Press ENTER/LAST if you want to go back to the prior channel.

I can't tune to one of my channels.

- You may be using a channel list that does not include the channel you want. Use the number buttons on the remote control to enter the channel number, then press the ENTER button. For more information on using a channel list, see page 89.
- The channel you want may be showing a program that exceeds a limit set with Parental Controls. In this case, you will be able to tune to the channel, but will see only a black screen with a notice that a limit has been exceeded. For more information, see page 90.
- Check to make sure you subscribe to the channel you are trying to tune to. Tune to the channel and read the message at the bottom of the screen.

I can't use the Favorite Channels channel list.

- The Favorite Channels list is empty until you put channels in it. For more information, see page 89.
- If category filtering of the guide is turned on, channels on your list of favorites may be being filtered out. You can use the guide's options to turn off filtering. See page 50.

When I power on my TV, I see the message “Searching for satellite signal....”

Your DVR is having trouble tuning to the channel you are on. Follow these steps to restore the video:

- Try changing channels. If you see the same message on every channel, your video cable may have come loose. Check to make sure all the cable connections on the back of your DVR are secure.
- If multiple channel changes do not work, try restarting your DVR. From DIRECTV Central, choose “Messages & Setup,” then “Restart or Reset System,” then “Restart the Recorder.” Follow the instructions on the screen to restart the DVR.
- In unusual circumstances, stormy weather may interfere with your satellite signal. If this is the case, the signal should return when the weather changes.
- Try replacing your video cables to determine if one of your cables is bad.
- The position of your satellite dish antenna may have changed and you may have to re-position it. Professional installers are available in most areas to position satellite dishes. You can also find positioning information by repeating Satellite Dish Guided Setup, available by pressing the DIRECTV button, then selecting “Messages & Setup” and then “Recorder & Phone Setup.”
- There may be an obstruction (for example, trees) between the satellite dish antenna and the sky. If this is the case, you may have to change the position of your satellite dish antenna.

The channel I want to watch has the message “This program is not available in your area,” and the image is blacked out.

- Some sports events may be blacked out in areas that are considered local areas for the events.

The audio and video are out of sync.

- Try changing channels.
- Press the PAUSE button on the remote control, then press BACK to move back a frame or two, then press PAUSE again to resume play.
- Press the DIRECTV button; then press the LIVE TV button to return to live television.
- Restart your DVR. From Messages & Setup select “Restart or Reset System,” then “Restart the Recorder.” You will see the Welcome screen and the system will restart within about 45 seconds.

My DVR was working, but now the picture does not move.

- First, press PLAY to be sure the video is not paused.
- Try to restart your DVR. From Messages & Setup select “Restart or Reset System,” then “Restart the Recorder.” You will see the Welcome screen and the system will restart within about 45 seconds.

I don't get a picture now, even though I have been able to get one in the past.

- Any time you have a problem with your system, you can run a system test. To run the test, from Messages & Setup, select “System Test.” The system test checks the DVR's signal, tuning, access card and phone connection.
- You may be able to fix the problem yourself. Try restarting the DVR: From Messages & Setup select “Restart or Reset System,” then “Restart the Recorder.” If you cannot fix the problem, call DIRECTV Customer Care at 1-800-DIRECTV (1-800-347-3288).

▶▶ Questions About Pick Programs to Record

There are very few or no shows listed when I press GUIDE or look for programs to record. I can't find my program in the listings, although I know it's on.

- Your DVR may not have all its program guide data yet. When you first begin to use your DVR, it begins to download guide information from the DIRECTV satellites. It takes a day or two before complete information (up to 14 days) is available for you to use. If you cannot find a specific show that you know is on, information for that show may not have been downloaded and indexed yet. Wait a few hours and then try to find your program again.
- The guide may be using a channel list that does not include the channel you are looking for. You can change the channels in a channel list, and change the channel list that the guide uses. See page 36.

What do the different icons on the Now Playing List screen mean?

- For a description of each icon's meaning, see the Glossary of Icons on the inside back cover of this guide.

Can I record multiple programs simultaneously?

- It depends on how many satellite Inputs you have connected to your DVR. With one input, you can only record one program at a time. With two inputs, you can utilize the dual tuner and record 2 programs at the same time, or record one program while watching another.

Can I recover a recorded program that was deleted?**How can I save a program longer?**

- Unfortunately, there is no way to bring back a program that has been deleted from the Now Playing List. You can, however, choose to save programs longer. From the Now Playing List, highlight the program you wish to save longer and press SELECT to display the Program Information screen. Here you can choose “Save until I delete,” or choose “Save Until...” to set the number of days before a program may be deleted.
- Be sure also that you pay attention to conflicts. You may choose not to approve any conflict that says it will delete a program sooner than you want.
- If the program was a Season Pass, you may have too many Season Pass items. In order to accommodate all of your Season Pass requests, programs may occasionally be saved for as little as one day. Try deleting some Season Pass requests.
- You can archive special recordings to a videotape to preserve them longer. From the Program Information screen, choose “Save to VCR.” See page 66.

How do I check the upcoming programs that I've scheduled to record?

- From the DIRECTV Central screen, select “Pick Programs to Record.” From there, select the To Do List.

How do I cancel a recording?

- If you change the channel while a program is recording, you will be given the option to cancel the recording.
- To cancel a scheduled recording: In the To Do List, highlight the program and press the “Clear” button.

What happens if a sports event I have scheduled to record goes into overtime?

- The DVR service cannot predict whether a sporting event might go into overtime, but we provide a feature that lets you add from one extra minute to three hours at the end of a recording. The Overtime Scheduler™ has two options: Start Recording and Stop Recording. Both are available on the Recording Options screen. You can even use the Overtime Scheduler to change the scheduled end of a recording while the program is still being recorded. You can use the Overtime Scheduler with any kind of program, not just sports. For more information, see page 62.

Can I schedule to record a program that will not be aired for months?

- You can create a WishList to set up recordings for programs that are not yet listed in the guide. For example, create a keyword WishList that uses the program’s title as the keyword. See page 73.

Can I save a program from the Now Playing List to my VCR?

- Yes. You can use the “Save to VCR” function. See page 66 for more information.

Can I copy or archive programs to a ZIP drive or any other computer storage media?

- No, the DVR does not copy or archive recordings to any device other than a VCR.

How do I go back to the beginning of a recording I’m watching?

- Press the ADVANCE button (⏩) on the remote to go to the end of a recording you’re watching. Press it again to go to the beginning.

How do I clear all the letters I've entered on the alphanumeric keypad and start over?

- Use the CLEAR button on the remote, or select “CLR” in the on-screen keypad. To remove one letter, select “DEL” in the keypad or press the BACK button on the remote.

How can I fit more programs on Now Playing List, and why does it tell me I don't have enough space?

- Your DVR can save a limited number of programs, and then it runs out of space. Usually, it then begins to delete old programs to make room for new recordings. However, if you have marked too many programs in Now Playing List “Save until I delete,” (programs marked “Save until I delete” have a green circle beside them) your DVR may tell you that you do not have enough space. To make space, delete some of the programs listed in the Now Playing List. You can delete a program by highlighting it in Now Playing List, then pressing CLEAR. On the confirmation screen that appears, press SELECT.

How do I set the clock so that my shows are recorded on time?

- Your DVR's internal clock is updated by the DIRECTV satellites. If you find that the DVR's time is consistently wrong, you can change the Time Zone and Daylight Savings Time settings manually, as described on page 105. If the clock still shows the wrong time, you can call DIRECTV Customer Care at the number on the back of this guide.

My program didn't get recorded. I set the DVR up to record something, and it's not in Now Playing List.

- If this happens, you can check Recording History for an explanation why the program did not record. Recording History is the first selection available in the To Do List. Here are some reasons why a program may not be available in the Now Playing List:
 - The program may have been canceled by the network.
 - You may have two season pass requests that were on at the same time this week. Only one can be recorded, unless you have dual tuner, in which case only two can be recorded at once. The DVR records the Season Pass (or Passes with dual tuner) with the highest priority. To change priority settings on Season Pass recordings, go to "Pick Programs to Record" and select "Season Pass Manager."
 - The program may have been deleted from the Now Playing List by someone else.
 - You may have gotten a conflict when requesting another program, and the proposed solution was to delete the missing program earlier than planned.
 - The DVR may have lost power during the time the program was broadcast.

I haven't scheduled enough programs to fill my DVR, but when I try to schedule more programs, the DVR says there isn't room.

- With satellite broadcasts, the amount of recording space the DVR needs varies from channel to channel and from show to show. In general, the more action you see on your screen, such as in fast-moving sports or action movies, the more recording space is required. The space required for each show you record affects the total hours of recording capacity in your DVR.

What does it mean when my DVR says programs will be deleted earlier than planned?

- By default, all programs except pay per view events are kept for at least two days. After that, programs may be deleted to make room for other recordings you request. Recordings of pay per view events are kept until you delete them. The DVR service uses this information to figure out not only what space will be available but when it will become available. If enough space will not be available at the time of recording, the DVR service tells you which programs would be deleted to make more room. However, you always have the final say on how long the DVR keeps recorded programs. You can delete programs at any time and can always change how long a program is saved by changing the “Save Until...” option described on page 60.

►► Questions About Parental Controls

My Parental Controls are not working.

- For Parental Controls to work, they must be on (and not temporarily turned off). Whenever you enter a password to bypass Parental Controls, Parental Controls become temporarily turned off. If they are turned off, you can turn them back on at the Parental Controls screen (see page 90), or by putting your DVR in standby mode and then taking it out of standby.

Do I have to change Parental Controls settings before I can watch a program that exceeds the current limits?

- No, you don't. You can enter the current password to temporarily turn off Parental Controls. If they are temporarily turned off, you can turn them back on at the Parental Controls screen (see page 90), or by putting your DVR in standby mode and then taking it out of standby.

I've lost my password for Parental Controls. What should I do?

- If you have lost your password, you can call DIRECTV Customer Care at the phone number provided on the back of this guide.

►► Questions About the DVR's Phone Calls

How long does the daily call to the DVR service take?

- It is typically a short call, less than three minutes. When the software is being updated, it may take longer, but this happens rarely (a few times a year).

My DVR is not making the daily call to the DVR service.

- If you use a wireless phone, retry the call using a phone which is connected to a standard wall jack.
- Verify that your phone line is working by connecting a phone to the phone cord and checking for a dial tone. Make sure the phone cord is connected to the DVR and the wall jack.
- Try another local dial-in number from the Phone Dialing Options screen. To get to Phone Dialing Options, from DIRECTV Central, select “Messages & Setup,” then “Recorder & Phone Setup,” then “Phone Connection,” then “Change Dialing Options.”
- You may need to change your Phone Dialing Options from the default. After making changes, make a test call. (Choose Make Test Call from the Phone Connection screen.) If the test call succeeds, choose “Make Daily Call Now.”
- If you have voice mail or use another non-standard dial tone, go to “Messages & Setup,” then “Recorder & Phone Setup,” then “Phone Connection,” then “Change Dialing Options.” Turn off “Dial Tone Detection.”

- If you have call waiting, go to “Messages & Setup,” then “Recorder & Phone Setup,” then “Phone Connection,” then “Change Dialing Options.” Disable call waiting by entering the correct prefix in Call Waiting Prefix (usually *70,).
- If you dial a prefix for outside lines, go to “Messages & Setup,” then “Recorder & Phone Setup,” then “Phone Connection,” then “Change Dialing Options.” Set a Dial Prefix—for example, “9,” (nine, followed by a comma for a pause).
- Your phone line may have low voltage. Try setting Phone avail. detection to Off under Dialing Options, described on page 101.
- If you have a caller ID box, try removing it from the line since some models interfere with the DVR modem's ability to make a call.
- If your DVR is having difficulty dialing out, try the following: Press LEFT arrow until you return to the Phone Dialing Options screen. Select Set Dial Prefix, and enter the dialing prefix “,#034” (comma, pound, zero, three, four). Use the PAUSE button to enter a comma, and the ENTER button to enter a pound. This command sets the DVR’s modem to a slower speed, which helps phone calls succeed in some environments. The DVR does not dial the prefix as part of the number.
- If you have a cordless telephone, fax machine, or computer modem connected to the same line, go to “Messages & Setup,” then “Recorder & Phone Setup,” then “Phone Connection,” then “Change Dialing Options.” Turn off “Phone avail. detection.”
- You might have too much line noise to make a connection. The DVR ships with a 25 foot phone cord. Try a shorter cord, or buy a line noise filter at your local electronics store.

Why does the DVR have to be connected to a phone line? Do I need to keep the phone connected all the time?

- The DVR should be plugged in to a land-based phone line at all times to receive the DVR service and DIRECTV® sports packages, and to communicate the purchase of pay per view events.

Does the DVR service phone call each day cost me any money?

- Calling the DVR service via your local dial-in number is the same as making a local telephone call.

Does the occasional phone call to DIRECTV cost me any money?

- No, because your DVR only calls DIRECTV periodically and a toll free number is used to make the call.

What if I need to make a call while the DVR is using the phone?

- When you pick up the phone, the DVR will interrupt the download process and free the phone line for your call. Hang up, wait at least 45 seconds, then pick up the line again to make a call. The DVR will attempt its call again later.

What if my phone line is not operating when the DVR tries to make a service call?

- The DVR will continue to attempt to call several times a day until it is successful. You can check the status of the phone calls by going to Messages & Setup and looking at the Phone Connection screen.

▶▶ Questions About Audio

I can't select an alternate audio track.

- Alternate audio tracks are not available for all programs. If a program has an alternate audio track, you can select it through the channel banner.
- Programs are recorded with only one audio track, either the primary or an alternate audio track, so you cannot select an alternate audio track on a recorded program.
- If you are watching a live program, but are not caught up to live TV (i.e., you could use the FORWARD button to move forward through the program), alternate audio will not be available until you catch up with live TV.

Programs are playing in the wrong language.

- There may be an alternate language selected in My Preferences. To check, press the DIRECTV button; then select “Messages & Setup,” and then “My Preferences.” Select “Audio Options,” then “Audio Language.” Make sure the language selected is the one you want to hear.
- An alternate audio track may be selected. (See page 96.)

▶▶ Questions About Pay Per View

How do I record a pay per view event?

- If it is on now, tune to the channel carrying the program and press RECORD.
- If it is on later, go to live TV, press the GUIDE button to see the guide. Highlight the program and press SELECT.

How do I cancel a pay per view purchase?

- You can cancel pay per view purchases before the program airs on the Purchases screen. For more information, see page 85.
- Pay per view purchases made by phone must be canceled by phone as well. (There is an additional \$1.50 charge when pay per view events and movies are ordered by phone utilizing the automated ordering system or an additional \$5.00 charge for an operator-assisted order.)

I can't order a pay per view program.

- It may be too late to purchase the program you want. To quickly see other times the program will be on, do this: In Live TV, tune to the station carrying the pay per view program you want. There should be a notice saying "This showing is no longer available." Press GUIDE to see the guide. Press the RECORD button to see Program Information for the program. Select "View upcoming showings." To see live TV again, press GUIDE.
- In general, pay per view events can be ordered through the DVR within 24 hours of their air time. If you see a message that says cost information is not available, you can wait until less than 24 hours before the program airs and try again.

- If the program exceeds a limit set with Parental Controls, and Parental Controls are on, you will need a password to view it.
- If you are attempting to order a pay per view selection with your remote control and cannot, call DIRECTV Customer Care at the number provided on the back of this guide.

I can't find the station of a pay per view program I ordered.

- Information about pay per view programs you have purchased using your remote control is available by selecting Messages & Setup from DIRECTV Central, and then selecting Purchases.

I can't cancel a pay per view purchase on the Purchases screen.

- You cannot cancel pay per view orders that you have watched, recorded, or tuned to.

▶▶ Questions About the Remote Control

My remote control doesn't work with my television.

- You need to program the DVR's remote control to control some functions of your television or audio/visual equipment. See page 109.

My remote control doesn't work with my DVR.

- Your remote control's batteries may be weak. If its batteries are weak, the red light on the end of the remote control will not flash when you press buttons.

►► Questions About the DIRECTV® DVR with TiVo® Service

How do I prevent TiVo Suggestions from being automatically recorded and listed on Now Playing List?

- Press the DIRECTV Button, then select “Messages & Setup,” then “My Preferences,” then “TiVo Suggestions,” then “No.”

Will my DVR still work without the DVR service?

- Without the DVR service, your DIRECTV® DVR will have no recording functionality. The DVR uses the DVR service to record shows you request, provide Season Pass recordings, allow you to search for programs by name, and so on. The DVR service also provides you with new Showcases. Lastly, the service keeps your DVR updated to make sure you have the most current functionality available for your DIRECTV® DVR.

Will the DVR service collect information about my viewing habits?

- At DIRECTV, we absolutely respect and guard your right to privacy. We have a privacy policy that maintains complete viewer confidentiality. DIRECTV has created a very sophisticated system with both protection and customization for our viewers in mind. It is DIRECTV’s promise to you that you will always maintain control over your personal information. For more information, see the DIRECTV Privacy Promise, included in your first monthly statement.

How does my TiVo Suggestions list get generated? How does it know what I like?

- Your personal TV preferences are based on programs you have rated with THUMBS UP and THUMBS DOWN. Also, any program you record that does not already have a Thumb rating is automatically given one THUMB UP.

TiVo Suggestions isn't making accurate suggestions for me.

- If you haven't had your DVR for very long, give it time. It may take a week or two of use before your personal preference profile has enough data to make interesting suggestions. The more you press THUMBS UP and THUMBS DOWN and the more programs you record, the better TiVo Suggestions will be.

If other members of your household are pressing THUMBS UP on shows you don't care for, and vice versa, you may find TiVo Suggestions is making some suggestions that you like, and some that are more appropriate for other members of your household.

Will I lose my personal preferences and my programs if I lose power temporarily?

- No, everything is saved—your personal preferences, your To Do List, and your Now Playing List programs—regardless of the length of time you have lost power. The only thing you might miss is a recording that was scheduled to occur during the time the power was out.

Warranty and Specifications

Limited Warranty	142
FCC Information	144
Specifications	146
Safety Instructions	148

▶▶ Limited Warranty

Limited Warranty

RCA Manufactured DIRECTV® DVR

90 Days Free Labor/One Year Parts Exchange

WHAT YOUR WARRANTY COVERS

Any defects in materials or workmanship.

FOR HOW LONG AFTER YOUR PURCHASE

- 90 days - Unit exchange, which includes parts and labor.
- 91 days to 1 year - Unit exchange, which includes parts only; you pay the labor.
- The warranty for rental units begins with the first rental or 45 days from date of shipment to the rental firm, whichever comes first.

WHAT WE WILL DO

During the initial 90 days:

- Exchange the defective unit with a new or, at our option, refurbished unit.

After the 90 days and within one year:

- Exchange the defective unit with a new or, at our option, refurbished unit. We will charge you a flat exchange cost to replace a defective unit. This charge covers the labor cost for its repair.

HOW YOU GET SERVICE

- Call 1-800-801-5875 and have your unit's date of purchase and model/serial number ready. The model/serial number information is on the back of your unit.
- A representative will troubleshoot your problem over the phone.

- If the representative determines that you should receive a replacement unit you will be provided with a Service Request (SR) number and the location of a nearby exchange point if one exists. No returns will be accepted without the SR number.

Thomson assumes no responsibility for warranty shipments from the customer to the factory if not shipped in the manner prescribed by Thomson.

WHAT YOUR WARRANTY DOES NOT COVER

- Acts of nature, such as but not limited to lightning damage.
- Adjustment of customer controls.
- Damage from misuse or neglect.
- A unit that has been modified or incorporated into other products or is used for institutional or other commercial purposes.
- Batteries.
- Units purchased, serviced or operated outside the U.S.A.
- Loss of programming.
- Installation.
- Shipping damage if the unit was not packed and shipped in the manner prescribed by Thomson.
- Storage fees may be charged by the exchange point if you fail to pick up the replacement unit in a timely manner.

PRODUCT REGISTRATION

Please complete the online Product Registration on www.rca.com or complete and mail the Product Registration Card packed with your unit. It will make it easier to contact you should it ever be necessary. The return of the card is not required for warranty coverage.

HOW STATE LAW RELATES TO WARRANTY

- Some states do not allow the exclusion nor limitation of incidental or consequential damages, or limitations on how long an implied warranty lasts, so the above limitations or exclusions may not apply to you.
- This warranty gives you specific legal rights, and you also may have other rights that vary from state to state.

IF YOU PURCHASED YOUR PRODUCT OUTSIDE THE UNITED STATES

This warranty does not apply. See your dealer for warranty information.

LIMITATION OF WARRANTY

- The warranty stated above is the only warranty applicable to this product. All other warranties, express or implied (including all implied warranties of merchantability or fitness for a particular purpose) are hereby disclaimed. No verbal or written information given by Thomson, its agents or employees shall create a guaranty or in any way increase the scope of this warranty.
- Repair or replacement as provided under this warranty is the exclusive remedy of the consumer. Thomson shall not be liable for incidental or consequential damages resulting from the use of this product or arising out of any breach of any express or implied warranty on this product. This disclaimer of warranties and limited warranty are governed by the laws of the State of Indiana. Except to the extent prohibited by applicable law, any implied warranty of merchantability or fitness for a particular purpose on this product is limited to the applicable warranty period set forth above.

►► FCC Information

Declaration of Conformity—Standards to which Conformity is declared: FCC Part 15

This device complies with Part 15 of the FCC Rules. Operation is subject to the following two conditions: (1) this device may not cause harmful interference, and (2) this device must accept any interference received, including interference that may cause undesired operation.

Responsible Party:

Thomson, 10330 North Meridian Street, Indianapolis, IN U.S.A. 46290.
580-634-0151

- Trade Name: RCA
- Type of Equipment: DIRECTV® DVR
- Model Number: DVR40 or DVR120

Federal Communications Commission (FCC): This equipment complies with both Part 15 and Part 68 of the FCC rules.

Your DIRECTV® DVR complies with the limits for a Class B digital device, pursuant to Part 15 of the FCC rules. These limits are designed to provide reasonable protection against harmful interference in a residential installation. This equipment generates, uses, and can radiate radio frequency energy and, if not installed and used in accordance with the instructions, may cause harmful interference to radio communications. However there is no guarantee that interference will not occur in a particular installation. If this equipment does cause harmful interference to radio or television reception, which can be determined by removing and applying power to the equipment, the user is encouraged to try to correct the interference by one or more of the following measures:

- Reorient or relocate the receiving satellite dish antenna.
- Increase the separation between the equipment and the DIRECTV Receiver.
- Connect the equipment into an outlet on a circuit different from that to which the DIRECTV Receiver is connected.
- Consult the dealer or an experienced radio/TV technician for help.

The user may find the following booklet, prepared by the Federal Communications Commission, helpful: “How to Identify and Resolve Radio and TV Interference Problems.” This booklet is available from the U.S. Government Printing Office, Washington, DC. To meet FCC requirement, only peripherals (computer input/output devices, terminals, printers, etc.) certified to comply with Class B limits may be attached to this device. Operation with noncertified peripherals is likely to result in interference to radio and TV reception. To meet FCC requirements, shielded cables are required to connect the device to a personal computer, peripheral, or other Class B certified device.

This equipment complies with Part 68 of the FCC Rules and the requirements adopted by ACTA. On the back of this equipment is a label that contains a product identifier in the format US:AAAEQ##TXXXX. If requested, this information must be provided to your telephone company.

A plug and jack used to connect this equipment to the premises wiring and telephone network must comply with the applicable FCC Part 68 rules and requirements adopted by ACTA. A compliant telephone cord and modular plug is provided with this product. It is designed to be connected to a compatible modular jack that is also compliant. See installation instructions for details.

The REN is used to determine the number of devices that may connect to a telephone line. Excessive RENs on a telephone line may result in the devices not ringing in response to an incoming call. In most but not all areas, the sum of the RENs should not exceed five (5.0). To be certain of the number of devices that may be connected to a line, as determined by the total RENs, contact your local telephone company. For product approved after July 23, 2001, the REN for this product is part of the product identifier that has the format US:AAAEQ##TXXXX. The digits represented by ## are the REN without the decimal point (e.g., 03 is a REN of 0.3). For earlier products, the REN is separately shown on the label.

If this DIRECTV® DVR causes harm to the telephone network, the telephone company will notify you in advance that temporary discontinuance of service may be required. But if advance notice isn't practical, the telephone company will notify the customer as soon as possible. Also, you will be advised of your right to file a complaint with the FCC if you believe it is necessary.

The telephone company may make changes in its facilities, equipment, operations or procedures that could affect the proper functioning of your equipment. If they do, you will be notified in advance in order for you to make necessary modifications to maintain uninterrupted service.

If trouble is experienced with this unit, for repair or warranty information, please contact customer care at the address and phone number listed below. If the equipment is causing harm to the network, the telephone company may request that you disconnect the equipment until the problem is resolved.

Thomson, 10330 North Meridian Street, Indianapolis, IN U.S.A. 46290.
580-634-0151

DO NOT DISASSEMBLE THIS EQUIPMENT. It does not contain any user-serviceable components.

We recommend the installation of an AC surge arrester in the AC outlet to which this equipment is connected. Telephone companies report that electrical surges, typically lightning transients, are very destructive to customer terminal equipment connected to AC power sources.

Note: The User is cautioned that changes or modifications not expressly approved by the party responsible for compliance could void the user's authority to operate the equipment.

If your home has specially wired alarm equipment connected to the telephone line, ensure the installation of this DIRECTV® DVR does not disable your alarm equipment. If you have questions about what will disable alarm equipment, consult your telephone company or a qualified installer.

Connection to party line service is subject to state tariffs. Contact the state public utility commission, public service commission, or corporation commission for information.

►► Specifications



CAUTION: To prevent electrical shock, match wide blade of plug to wide slot, and fully insert.



Recording capacity depends on signal quality and type of programming being recorded.

Satellite In:	F-Type Connector Female (2)
Video Out:	S-Video 4-Pin Mini DIN Composite Video RCA (2)
Audio Out:	Stereo L/R RCA (2 pairs) Optical SPDIF Digital
RF In:	F-Type Connector Female
RF Out:	F-Type Connector Female Channel 3 or 4 switchable
Telephone:	RJ-11 Female, 2-Wire
Control Out:	3.5mm Mini Jack Sockets (2)
Card Slot:	Access Card Connector
Expansion Port	USB (2)
Power:	120VAC, 60Hz, 40W
Ambient (external) Operating Temperature:	15° C to 35° C
Operating Humidity:	5% to 80%
Dimensions:	15" w X 12" d X 3" h
Remote Control:	36 Button with AA Batteries (2)
Modem	v.34 capable

MACROVISION COPYRIGHT PROTECTION

The DVR incorporates copyright protection technology that is protected by U.S. patents and other intellectual property rights. Use of this copyright protection technology must be authorized by Macrovision, and is intended for home and other limited pay per view uses only unless otherwise authorized by Macrovision. Reverse engineering or disassembly is prohibited. U.S. patent Nos. 4,631,603, 4,577,216, 4,819,098 and 4,907,093 licensed for limited pay per view uses only.

LINUX SOURCE NOTICE

The DIRECTV[®] DVR is powered by the Linux operating system. The machine-readable copy of the corresponding source code is available for the cost of distribution. Please visit www.tivo.com/linux for more information. To read the Linux software license, see Appendix B, “GNU General Public License” on page 155.

TELEPHONE LINE INTERRUPTION

Periodically, the DIRECTV[®] DVR dials in to the DVR service via your telephone line. If you pick up your telephone during the time information is being transferred, you will hear static noise. If you would like to use your telephone while the information is being transferred, you can hang up, wait at least 45 seconds, and pick up your telephone again. The DVR will disconnect and allow you to place your call. You can also interrupt the transfer at any time by temporarily unplugging the phone line from the DVR. If the transfer is interrupted, it will resume at a later time.

DIRECTV UPGRADES

Your DVR is able to receive upgrades or modifications to some of its features and functions. These modifications will occur automatically, usually at times when the DVR would not be in use. If your DVR is in use when an upgrade or modification is sent, you may experience a disruption in reception for a minute or two. Your reception should return

to normal after the modification is complete. Your DVR must be plugged in to receive the upgrade. Do not unplug your receiver while an upgrade is in progress.

LOCAL CHANNELS FROM DIRECTV

With this DVR and the proper satellite dish antenna, you may be able to subscribe to local channels from DIRECTV in certain areas. Additional equipment may be required in some markets. Check with your retailer or visit DIRECTV.com for information on availability of local channels from DIRECTV in your area.

DIRECTV DISCLAIMERS

DIRECTV programming and DIRECTV DVR service subscriptions required and sold separately.

Activation of programming may be subject to credit approval and requires valid service address, social security number and/or major credit card. Deposit or prepayment may be required. Programming subject to change. You must be physically located in the U.S. to be an authorized DIRECTV customer. DIRECTV services not provided outside the U.S. DIRECTV programming is sold separately and independently of DIRECTV System hardware. A valid programming subscription is required to operate DIRECTV System hardware. Activate your DIRECTV programming today at 1-800-DIRECTV (1-800-347-3288).

Receipt of DIRECTV programming is subject to the terms of the DIRECTV Customer Agreement; a copy is provided in your first billing statement. DIRECTV service not available outside the U.S. Signal theft is subject to civil and criminal penalties.

For full functionality, this recorder requires connection of two (2) satellite inputs from a dual-LNB DIRECTV System dish antenna; the second satellite input must be connected into the recoder's Satellite 2 In jack. Professional installation required.

▶▶ Safety Instructions

This product was designed and manufactured to meet strict quality and safety standards. There are, however, some installation and operation precautions of which you should be particularly aware. Please read these instructions before operating the equipment and save them for future reference.

1. **Read Instructions**—All the safety and operating instructions should be read and understood before the appliance is operated.
2. **Retain Instructions**—The safety and operating instructions should be retained for future reference.
3. **Heed Warnings**—All warnings on the appliance and in the operating instructions should be followed.
4. **Follow Instructions**—All operating and use instructions should be followed.
5. **Water and Moisture**—The appliance should not be used near water—for example, near a bathtub, washbowl, kitchen sink, laundry tub, in a wet basement or near a swimming pool, etc.
6. **An appliance and cart combination should be moved with care.** Quick stops, excessive force, and uneven surfaces may cause the appliance and cart combination to overturn.
7. **Tilt/Stability**—All televisions must comply with recommended international global safety standards for tilt and stability properties of their cabinet design. Do not compromise these design standards by applying excessive pull force to the front, or top, of the cabinet, which could ultimately overturn the product. Also, do not endanger yourself, or children, by placing electronic equipment/toys on top of the cabinet. Such items could unexpectedly fall from the top of the set and cause product damage and/or personal injury.
8. **Ventilation**—This appliance should be situated so that its location or position does not interfere with its proper ventilation. The openings should never be blocked by placing the product on a bed, sofa, rug, or similar surface. This product should not be placed in a built-in installation such as a bookcase or rack unless proper ventilation is provided.
9. **Heat**—The appliance should be situated away from heat sources such as radiators, heat registers, stoves, or other appliances (including amplifiers) that produce heat.
10. **Power Cord Protection**—Power supply cords should be routed so that they are not likely to be walked on or pinched by items placed upon or against them, paying particular attention to cords and plugs, convenience receptacles, and the point where they exit from the appliance.
11. **Battery Caution**—Danger of explosion if battery is incorrectly replaced. Replace only with the same or equivalent type recommended by the manufacturer. Dispose of used batteries according to the manufacturer's instructions.

12. Object and Liquid Entry—Never push objects of any kind into this product through cabinet slots, as they may touch dangerous voltage points or short the parts, resulting in the risk of fire or electric shock. Never spill liquid of any kind on this product.
13. Damage Requiring Service—The appliance should be serviced by qualified service personnel when:
- The power supply cord or plug is damaged or frayed;
 - Liquid has spilled into the product;
 - The product has been exposed to rain or water;
 - The product does not operate normally when you follow the operating instructions (adjust only those controls that are discussed in the User's Guide, as improper adjustment of other controls may result in damage, often requiring extensive work by a qualified technician to restore the product to normal performance);
 - The product has been dropped or the cabinet damaged;
 - The product exhibits a distinct change in performance.
14. Servicing—The user should not attempt service to the appliance beyond that described in the Troubleshooting section of this guide. All other servicing should be referred to qualified service personnel.
15. Cleaning—Unplug this product from the wall outlet before cleaning. Do not use liquid cleaners or aerosol cleaners; use a damp cloth for cleaning. If the product comes in contact with any liquid, unplug the phone line and the power adapter and let the unit dry thoroughly before plugging it back in.
16. Power Source—This product should be operated only from the type of power source indicated on the marking label or in the User's Guide. If you are not sure of the type of power supply to your home, consult your dealer or local power company.
17. Overloaded Power Outlets—do not overload wall outlets and extension cords, as this can result in the risk of fire or electric shock.
18. Electric Shock—To reduce the risk of electric shock, do not disassemble this product. Take it to a qualified serviceperson when service or repair work is required. Opening or removing covers may expose you to dangerous voltage or other risks. Incorrect reassembly can cause electric shock when this product is subsequently used.
19. Telephone Usage—When using your telephone equipment, basic safety precautions should be always followed to reduce the risk of fire, electric shock and injury to persons. To reduce the risk of fire, use only No. 26 AWG or larger telecommunication line cord.
20. Movement—Avoid moving the unit while it is plugged in to avoid accumulative shock and vibration damage to the internal hard disk drive.

21. Polarization—The DIRECTV® DVR is equipped with a plug that will fit into the power outlet only one way. Do not modify the plug. If the plug does not fit, contact your electrician to replace your outlet. To prevent electric shock, do not use this plug with an extension cord or outlet unless you can fully insert the blades without blade exposure.

22. Satellite Dish Antenna Grounding—The outdoor satellite dish antenna and the cable which connects the satellite dish antenna to the DVR must comply with local installation codes and the appropriate sections of the National Electric Code (NEC). In particular they must comply with Article 810-15, which covers proper installation and grounding of television receiving equipment. They must also comply with Article 820-33, which specifies that the satellite dish antenna cable ground shall be connected to the grounding system of the building as close to the point of cable entry as is practical. These codes require proper grounding of the metal structure of the outdoor satellite dish antenna and grounding of the connecting cable at a point where it enters the house (or other building). If a professional installs the Satellite Dish Antenna, be sure that the installer observes installation codes. If additional local installation codes apply, contact local inspection authorities. It is important to comply with these codes for proper operation of the DVR.

Example of Proper Antenna Grounding

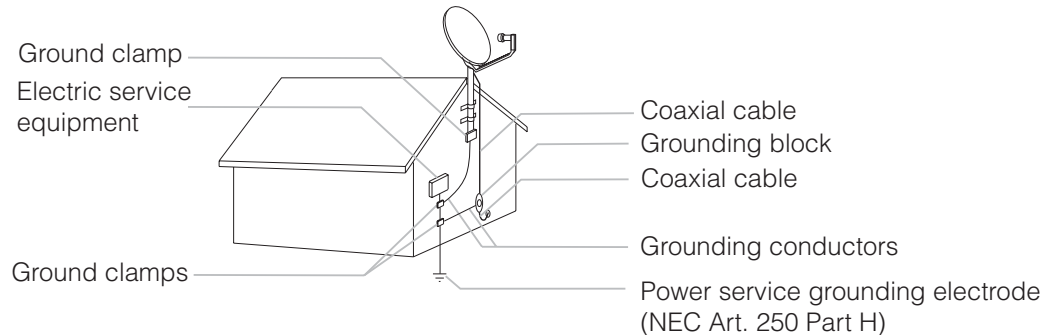

Note: If the Satellite/Antenna cable is grounded correctly (as specified above), connecting it to the DIRECTV® DVR will properly ground the DVR. The DVR must be properly grounded before you connect it to a telephone line, and it must remain grounded thereafter.

Back Panel Reference

►► Back Panel Reference

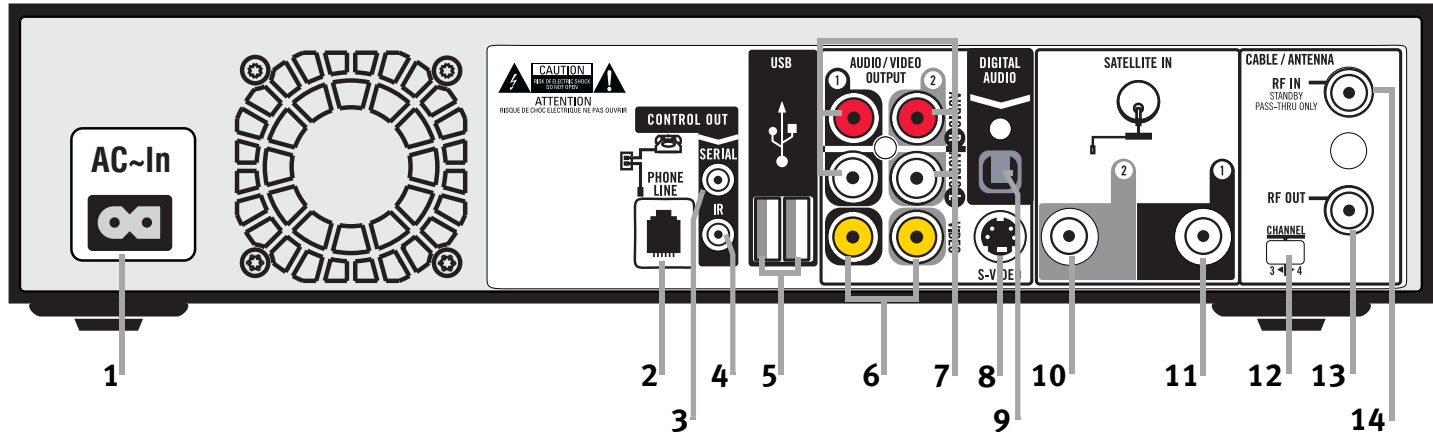

This section describes the use of the connection jacks and switch on the back panel of the DIRECTV® DVR. If your setup doesn't match any of the examples, you can use this information for general reference as you set up your equipment.

1. **AC ~ In:** When you've finished making all of the other connections, plug the AC power cord (supplied) into this opening to turn on the DVR. The DVR does not use a separate on/off switch; plugging it in switches it on.
2. **Phone Line:** Connect the DVR to your phone line using the telephone cord (supplied) and optional telephone line splitter (supplied). Your DVR needs to be connected to a phone line to receive updates from DIRECTV. The DVR occasionally makes a brief phone call to get updates to the DVR service and Showcases, and for pay per view

functionality. Do not connect the DVR to digital PBX systems. Doing so may permanently damage your DVR's modem and will void your warranty.

3. Cntrl Out (Serial): For future use.
4. Cntrl Out (IR): For future use.
5. USB (Universal Serial Bus) (2): For future use.
6. Composite Video Outputs (2): If your TV or VCR has a Composite Video jack you can connect the DVR to your TV or VCR's Video In using the yellow video connector on the Composite Video cable (supplied). If you have both a TV and a VCR, you might use one cable for the TV and another cable (not supplied) for the VCR.
7. L/R Audio Outputs (2 each): If your TV or stereo features Composite Input jacks, connect the Left (white) and Right (red) Audio Output jacks from the DVR to your TV or stereo using the L/R Audio cables (supplied). If you have both a TV and a VCR, you might use one set of L/R Audio cables for the TV and another set (not supplied) for the VCR; see chapter 1 of this guide for examples. If you are using an S-Video cable to connect to your TV or VCR, you must use it with the L/R Audio outputs. Ignore the L/R Audio jacks if you're using RF Out or Digital Audio Out.
8. S-Video Output: If your TV or VCR features an S-Video input jack, you can connect it to the DVR using an S-Video cable. S-Video provides a higher quality picture than composite. If you use the S-Video Output, you must also connect the supplied L/R Audio outputs (red and white cable ends). When connecting S-Video and the red and white L/R Audio outputs, do not plug in the yellow Composite Video cable.
9. Digital Audio Out: You can use the Digital Audio Out to connect your DVR to an A/V receiver with a digital audio input. To do so, you will need an optical audio cable (not supplied). Ordinarily, your DVR produces tones to indicate when certain buttons on

the remote control are pressed or to indicate signal strength when you are positioning your dish. If you use Digital Audio Out, you will not hear these tones.

10. Satellite In 2: If you have a Dual LNB satellite dish, you can connect the second satellite cable from your wall to the Satellite In 2 jack. Connecting both Satellite In 1 and Satellite In 2, and completing the required steps in Satellite Setup, allows you to record two programs at the same time (dual tuner).
11. Satellite In 1: Connect the satellite cable from your wall to the Satellite In 1 jack. You will not be able to watch DIRECTV® channels if you do not make this connection.
12. Channel 3/4 Switch: If you use RF Out, set the output to channel 3 or 4 using this switch. To get the best picture, select the channel that is not occupied by a local broadcast channel. For example, if there is a local broadcast station on channel 4, select channel 3 for the output on the DVR. You need to set your television to this channel (3 or 4) in order to view programs through the DVR.
13. RF Out: If your TV only has RF In, connect the DVR to your TV's RF In using the coaxial RF cable (supplied). The RF In jack on your TV may not be labeled "RF In;" it may be labeled "VHF/UHF In" or "Antenna/Cable In" instead. If your TV has multiple inputs and you can use the DVR's S-Video Output or Composite Video Output, don't use this jack.
14. RF In: If you use an antenna, and your TV has only one input, connect your antenna to the DVR using your existing coaxial RF cable (the one coming out of the wall). If your TV has multiple inputs, you can ignore this jack and connect your antenna directly to your TV instead. You will NOT be able to use DIRECTV and DVR functions while watching antenna or cable channels, even if you connect your antenna or cable directly to your DVR.

APPENDIX **B**

GNU General Public License

▶▶ GNU General Public License

Version 2, June 1991

Copyright (C) 1989, 1991 Free Software Foundation, Inc.

59 Temple Place, Suite 330, Boston, MA 02111-1307 USA

Everyone is permitted to copy and distribute verbatim copies of this license document, but changing it is not allowed.

Preamble

The licenses for most software are designed to take away your freedom to share and change it. By contrast, the GNU General Public License is intended to guarantee your freedom to share and change free software—to make sure the software is free for all its users. This General Public License applies to most of the Free Software Foundation’s software and to any other program whose authors commit to using it. (Some other Free Software Foundation software is covered by the GNU Library General Public License instead.) You can apply it to your programs, too.

When we speak of free software, we are referring to freedom, not price. Our General Public Licenses are designed to make sure that you have the freedom to distribute copies of free software (and charge for this service if you wish), that you receive source code or can get it if you want it, that you can change the software or use pieces of it in new free programs; and that you know you can do these things.

To protect your rights, we need to make restrictions that forbid anyone to deny you these rights or to ask you to surrender the rights. These restrictions translate to certain responsibilities for you if you distribute copies of the software, or if you modify it.

For example, if you distribute copies of such a program, whether gratis or for a fee, you must give the recipients all the rights that you have. You must make sure that they, too, receive or can get the source code. And you must show them these terms so they know their rights.

We protect your rights with two steps: (1) copyright the software, and (2) offer you this license which gives you legal permission to copy, distribute and/or modify the software.

Also, for each author’s protection and ours, we want to make certain that everyone understands that there is no warranty for this free software. If the software is modified by someone else and passed on, we want its recipients to know that what they have is not the original, so that any problems introduced by others will not reflect on the original authors’ reputations.

Finally, any free program is threatened constantly by software patents. We wish to avoid the danger that redistributors of a free program will individually obtain patent licenses, in effect making the program proprietary. To prevent this, we have made it clear that any patent must be licensed for everyone’s free use or not licensed at all.

The precise terms and conditions for copying, distribution and modification follow.

GNU GENERAL PUBLIC LICENSE

Terms and conditions for copying, distribution and modification.

0. This License applies to any program or other work which contains a notice placed by the copyright holder saying it may be distributed under the terms of this General Public License. The “Program,” below, refers to any such program or work, and a “work based on the Program” means

either the Program or any derivative work under copyright law: that is to say, a work containing the Program or a portion of it, either verbatim or with modifications and/or translated into another language. (Hereinafter, translation is included without limitation in the term “modification”.) Each licensee is addressed as “you”.

Activities other than copying, distribution and modification are not covered by this License; they are outside its scope. The act of running the Program is not restricted, and the output from the Program is covered only if its contents constitute a work based on the Program (independent of having been made by running the Program). Whether that is true depends on what the Program does.

1. You may copy and distribute verbatim copies of the Program's source code as you receive it, in any medium, provided that you conspicuously and appropriately publish on each copy an appropriate copyright notice and disclaimer of warranty; keep intact all the notices that refer to this License and to the absence of any warranty; and give any other recipients of the Program a copy of this License along with the Program.

You may charge a fee for the physical act of transferring a copy, and you may at your option offer warranty protection in exchange for a fee.

2. You may modify your copy or copies of the Program or any portion of it, thus forming a work based on the Program, and copy and distribute such modifications or work under the terms of Section 1 above, provided that you also meet all of these conditions:

a) You must cause the modified files to carry prominent notices stating that you changed the files and the date of any change.

b) You must cause any work that you distribute or publish, that in whole or in part contains or is derived from the Program or any part thereof, to be licensed as a whole at no charge to all third parties under the terms of this License.

c) If the modified program normally reads commands interactively when run, you must cause it, when started running for such interactive use in the most ordinary way, to print or display an announcement including an appropriate copyright notice and a notice that there is no warranty (or else, saying that you provide a warranty) and that users may redistribute the program under these conditions, and telling the user how to view a copy of this License. (Exception: if the Program itself is interactive but does not normally print such an announcement, your work based on the Program is not required to print an announcement.)

These requirements apply to the modified work as a whole. If identifiable sections of that work are not derived from the Program, and can be reasonably considered independent and separate works in themselves, then this License, and its terms, do not apply to those sections when you distribute them as separate works. But when you distribute the same sections as part of a whole which is a work based on the Program, the distribution of the whole must be on the terms of this License, whose permissions for other licensees extend to the entire whole, and thus to each and every part regardless of who wrote it.

Thus, it is not the intent of this section to claim rights or contest your rights to work written entirely by you; rather, the intent is to exercise the right to control the distribution of derivative or collective works based on the Program.

In addition, mere aggregation of another work not based on the Program with the Program (or with a work based on the Program) on a volume of a storage or distribution medium does not bring the other work under the scope of this License.

3. You may copy and distribute the Program (or a work based on it, under Section 2) in object code or executable form under the terms of Sections 1 and 2 above provided that you also do one of the following:

a) Accompany it with the complete corresponding machine-readable source code, which must be distributed under the terms of Sections 1 and 2 above on a medium customarily used for software interchange; or,

b) Accompany it with a written offer, valid for at least three years, to give any third party, for a charge no more than your cost of physically performing source distribution, a complete machine-readable copy of the corresponding source code, to be distributed under the terms of Sections 1 and 2 above on a medium customarily used for software interchange; or,

c) Accompany it with the information you received as to the offer to distribute corresponding source code. (This alternative is allowed only for noncommercial distribution and only if you received the program in object code or executable form with such an offer, in accord with Subsection b above.)

The source code for a work means the preferred form of the work for making modifications to it. For an executable work, complete source code means all the source code for all modules it contains, plus any associated interface definition files, plus the scripts used to control compilation and installation of the executable. However, as a special exception, the source code distributed need not include anything that is normally distributed (in either source or binary form) with the major components (compiler, kernel, and so on) of the operating system on which the executable runs, unless that component itself accompanies the executable.

If distribution of executable or object code is made by offering access to copy from a designated place, then offering equivalent access to copy the source code from the same place counts as distribution of the source code, even though third parties are not compelled to copy the source along with the object code.

4. You may not copy, modify, sublicense, or distribute the Program except as expressly provided under this License. Any attempt otherwise to copy, modify, sublicense or distribute the Program is void, and will automatically terminate your rights under this License.

However, parties who have received copies, or rights, from you under this License will not have their licenses terminated so long as such parties remain in full compliance.

5. You are not required to accept this License, since you have not signed it. However, nothing else grants you permission to modify or distribute the Program or its derivative works. These actions are prohibited by law if you do not accept this License. Therefore, by modifying or distributing the Program (or any work based on the Program), you indicate your acceptance of this License to do so, and all its terms and conditions for copying, distributing or modifying the Program or works based on it.

6. Each time you redistribute the Program (or any work based on the Program), the recipient automatically receives a license from the original licensor to copy, distribute or modify the Program subject to these terms and conditions. You may not impose any further restrictions on the recipients' exercise of the rights granted herein. You are not responsible for enforcing compliance by third parties to this License.

7. If, as a consequence of a court judgment or allegation of patent infringement or for any other reason (not limited to patent issues), conditions are imposed on you (whether by court order, agreement or otherwise) that contradict the conditions of this License, they do not excuse you from the conditions of this License. If you cannot distribute so as to satisfy simultaneously your obligations under this License and any other pertinent obligations, then as a consequence you may not distribute the Program at all. For example, if a patent license would not permit royalty-free redistribution of the Program by all those who receive

copies directly or indirectly through you, then the only way you could satisfy both it and this License would be to refrain entirely from distribution of the Program.

If any portion of this section is held invalid or unenforceable under any particular circumstance, the balance of the section is intended to apply and the section as a whole is intended to apply in other circumstances.

It is not the purpose of this section to induce you to infringe any patents or other property right claims or to contest validity of any such claims; this section has the sole purpose of protecting the integrity of the free software distribution system, which is implemented by public license practices. Many people have made generous contributions to the wide range of software distributed through that system in reliance on consistent application of that system; it is up to the author/donor to decide if he or she is willing to distribute software through any other system and a licensee cannot impose that choice.

This section is intended to make thoroughly clear what is believed to be a consequence of the rest of this License.

8. If the distribution and/or use of the Program is restricted in certain countries either by patents or by copyrighted interfaces, the original copyright holder who places the Program under this License may add an explicit geographical distribution limitation excluding those countries, so that distribution is permitted only in or among countries not thus excluded. In such case, this License incorporates the limitation as if written in the body of this License.

9. The Free Software Foundation may publish revised and/or new versions of the General Public License from time to time. Such new versions will be similar in spirit to the present version, but may differ in detail to address new problems or concerns.

Each version is given a distinguishing version number. If the Program specifies a version number of this License which applies to it and “any later version”, you have the option of following the terms and conditions either of that version or of any later version published by the Free Software Foundation. If the Program does not specify a version number of this License, you may choose any version ever published by the Free Software Foundation.

10. If you wish to incorporate parts of the Program into other free programs whose distribution conditions are different, write to the author to ask for permission. For software which is copyrighted by the Free Software Foundation, write to the Free Software Foundation; we sometimes make exceptions for this. Our decision will be guided by the two goals of preserving the free status of all derivatives of our free software and of promoting the sharing and reuse of software generally.

No Warranty

11. Because the program is licensed free of charge, there is no warranty for the program, to the extent permitted by applicable law. Except when otherwise stated in writing the copyright holders and/or other parties provide the program “as is” without warranty of any kind, either expressed or implied, including, but not limited to, the implied warranties of merchantability and fitness for a particular purpose. The entire risk as to the quality and performance of the program is with you. Should the program prove defective, you assume the cost of all necessary servicing, repair or correction.

12. In no event unless required by applicable law or agreed to in writing will any copyright holder, or any other party who may modify and/or redistribute the program as permitted above, be liable to you for damages, including any general, special, incidental or consequential damages arising out of the use or inability to use the program (including

but not limited to loss of data or data being rendered inaccurate or losses sustained by you or third parties or a failure of the program to operate with any other programs), even if such holder or other party has been advised of the possibility of such damages.

End of terms and conditions.

How to Apply These Terms to Your New Programs

If you develop a new program, and you want it to be of the greatest possible use to the public, the best way to achieve this is to make it free software which everyone can redistribute and change under these terms.

To do so, attach the following notices to the program. It is safest to attach them to the start of each source file to most effectively convey the exclusion of warranty; and each file should have at least the “copyright” line and a pointer to where the full notice is found.

<one line to give the program’s name and a brief idea of what it does.>

Copyright (C) <year> <name of author>

This program is free software; you can redistribute it and/or modify it under the terms of the GNU General Public License as published by the Free Software Foundation; either version 2 of the License, or (at your option) any later version.

This program is distributed in the hope that it will be useful, but WITHOUT ANY WARRANTY; without even the implied warranty of MERCHANTABILITY or FITNESS FOR A PARTICULAR PURPOSE. See the GNU General Public License for more details.

You should have received a copy of the GNU General Public License along with this program; if not, write to the Free Software Foundation, Inc., 59 Temple Place, Suite 330, Boston, MA 02111-1307 USA

Also add information on how to contact you by electronic and paper mail.

If the program is interactive, make it output a short notice like this when it starts in an interactive mode:

Gnomovision version 69, Copyright (C) year name of author

Gnomovision comes with ABSOLUTELY NO WARRANTY; for details type ‘show w’.

This is free software, and you are welcome to redistribute it under certain conditions; type ‘show c’ for details.

The hypothetical commands ‘show w’ and ‘show c’ should show the appropriate parts of the General Public License. Of course, the commands you use may be called something other than ‘show w’ and ‘show c’; they could even be mouse-clicks or menu items—whatever suits your program.

You should also get your employer (if you work as a programmer) or your school, if any, to sign a “copyright disclaimer” for the program, if necessary. Here is a sample; alter the names:

Yoyodyne, Inc., hereby disclaims all copyright interest in the program ‘Gnomovision’ (which makes passes at compilers) written by James Hacker.

<signature of Ty Coon>, 1 April 1989

Ty Coon, President of Vice

This General Public License does not permit incorporating your program into proprietary programs. If your program is a subroutine library, you may consider it more useful to permit linking proprietary applications with the library. If this is what you want to do, use the GNU Library General Public License instead of this License.

Index

- A**
- A/V receiver 7
 - Programming remote to control 110
 - Access Card 6
 - Accessories and cables 9
 - Activate DIRECTV and DVR Services 29
 - Actor WishList. See WishList.
 - Advance button 52
 - Advisories 63
 - Anamorphic 98
 - Antenna or cable connection 4
 - Area Code 30
 - see also Dial-In Number
 - Aspect Ratio 98
 - Audio cables
 - Choosing 10
 - Audio Controls
 - Choosing alternate audio on the Channel Banner 51
 - Setting preferences 96
 - Audio language 97
 - Auto re-lock option for Parental Controls 91
 - Auto-recording WishList
 - Setting up 78
- B**
- Back button 52
 - Back Panel Reference 152–154
- C**
- BNC cable 7
 - Browse by Channel 71
 - Browse by Time 70
- C**
- Cable connection or antenna 4
 - Cables and accessories 9
 - Call waiting 103
 - Call waiting prefix 103
 - Capacity 129
 - Category Only WishList. See WishList.
 - Channel Banner 51
 - Clearing the banner quickly 96
 - Channels
 - Changing your lineup 89
 - Creating channel lists 89
 - Customize channels 89
 - Favorite 89
 - Locking channels. See Parental Controls.
 - Using channel lists in the Program Guide 50
 - Channels You Receive 89
 - Clock
 - How the DVR's clock is set 128
 - Coaxial cable 10
 - Coaxial RF cable 7
 - Code search
 - Performing 112
 - Composite A/V cable 6, 10
 - Customer Support 118
 - Customize channels. See channels.
- D**
- Daily Call 132
 - Daylight Savings 105
 - Dial Prefix 103
 - Dial Tone Detection 104
 - Dial-In Number 30
 - Dial-In number 102
 - Dialing options 101
 - Digital audio 11
 - Digital PBX phone system 8
 - Digital video cable 10
 - Director WishList. See WishList.
 - DIRECTV Messages 84
 - DIRECTV Service iii
 - Dolby Digital Audio 8
 - Dolby Digital Audio 96
 - Dolby Surround Sound 8
 - Dual LNB 3
 - Dual Tuner 6
- F**
- Favorite Channels 36
 - Customize Channels and 89
 - Favorite channels 89
 - Favorites 89
 - FCC information 144
 - Filter
 - Filter the program Guide 50
 - see also Channels, Customize Channels
 - Forward

Fast Forward 52
Forward button 52
Frame Back 52
Frame Forward 52

G

Glossary of Icons vii
GNU General Public License 156

I

In jack 2
Instant replay button 52

J

Jacks 2

L

Language
 Audio language 97
Letterbox 49, 98
Linux software license 156
LINUX source, obtaining 147
Live TV 52

M

Macrovision 147
Manual Season Pass 72
Manually Record Time/Channel 72
Messages 84
MPAA Ratings 63

Multiswitch 6
MUTE button, programming 111
My Preferences 89

N

Network Showcases 40

O

Optical (or digital) audio cable 7
Out jack 2

P

Pan-and-Scan 98
Parental Controls 90–96
 Channel Lock 95
 Lost password 131
 Spending limit 95
Parental Controls Auto Re-lock option 91
Password
 Lost Parental Controls Password 131
Pause button 52
Pay per view 86
 For spending limits, see also Parental Controls
Performing a code search 112
Phone Avail. Detection 104
Phone connection
 Daily call 101
 Test call 101
Phone jack 3
Phone line 3

Interruption 147
Phone Number 118
Phone Setup 30
Phone Troubleshooting 132
Program Guide
 Display Options 50
Program Guide Data 28
Program Guide Options 37
Program Information
 Pay per view 86
Programmable buttons
 Resetting 114

R

Rating Settings
 MMPA definitions 94
 Movies and 92
 TV Content and 92
 TV Movies and 92
 TV ratings definitions 94
Ratings 63
Record
 From live TV 47
Recording History 66
Recording Options
 Keep At Least 62
 Keep At Most 61
 Keep Until 61
 Show Type 61
 Start Recording 62
 Stop Recording 62

- Remote control
 - Incompatibility with some makes and models 113
 - Using 24
 - Using with both TV and A/V equipment 110

- Reset System 108
- Restarting the DVR 108
- RF coaxial cable 10

S

- Safety instructions 148
- Satellite dish antenna types 5
- Satellite Dish Guided Setup 25
- Satellite Receiver 5
- Satellite Signal Strength 26
- Satellite Signal Troubleshooting 28
- Save longer, see Save Until...
- Save Until... 58
- Setup
 - Activate DIRECTV and DVR Service 29
 - Overview 24
 - Phone Setup 30
 - Satellite Dish Guided Setup 25
- Setup examples 10
- Signal Strength, Satellite 26
- Slow button 52
- Sound Effects Volume 97
- Sound effects volume 97
- Splitter, telephone 7
- Status Bar 53

- Surge protector 4, 8
- S-video cable 10
- Switch box 7
- System Information 106
- System Reset 108
- System Test 105

T

- Terms, useful 5
- Test signal strength 99
- Thumb ratings 41
 - Resetting 108
- Thumbs Up and Thumbs Down
 - see also TiVo Suggestions
- Time
 - How the DVR's clock is set 128
- Time Zone 105
- TiVo Logo viii
- TiVo Suggestions
 - Resetting 108
- TiVolution Magazine 40
- Tone/Pulse 103
- Transponder 6
- Troubleshooting
 - General 117–140
 - Satellite Signal 28
- TV Aspect Ratio 98
- TV INPUT button, programming 111
- TV PWR button, programming 111

V

- Video cables
 - Choosing 10
- View Upcoming 64
- VOLUME button, programming 111

W

- Warranty 142–143
- Watching recorded programs 58
- Wide screen TV, see TV Aspect Ratio
- WishList 73–78
 - Actor WishList 75
 - Auto-recording WishLists 78
 - Browsing 78
 - Category Only WishList 75
 - Director WishList 75
 - Editing 78
 - Keyword tips and 77
 - Keyword WishLists 76
 - View all upcoming and 78

Free Manuals Download Website

<http://myh66.com>

<http://usermanuals.us>

<http://www.somanuals.com>

<http://www.4manuals.cc>

<http://www.manual-lib.com>

<http://www.404manual.com>

<http://www.luxmanual.com>

<http://aubethermostatmanual.com>

Golf course search by state

<http://golfingnear.com>

Email search by domain

<http://emailbydomain.com>

Auto manuals search

<http://auto.somanuals.com>

TV manuals search

<http://tv.somanuals.com>