

DIRECTV® Receiver User Guide

D10-300



Know these safety symbols



This “bolt of lightning” indicates uninsulated material within your unit may cause an electrical shock. For the safety of everyone in your household, please do not remove product covering.

The “exclamation point” calls attention to features for which you should read the enclosed literature closely to prevent operating and maintenance problems.

WARNING: TO PREVENT FIRE OR SHOCK HAZARD, DO NOT EXPOSE THIS EQUIPMENT TO RAIN OR MOISTURE.

CAUTION: To prevent electric shock, this apparatus shall be connected to a mains socket outlet with a protective earthing and fully inserted.

For Customer Use

Enter below the Model, Serial and Access Card Number, and Receiver ID located behind front door of the DIRECTV® Receiver. Retain this information for future reference.

Model No. _____

Serial No. _____

Access Card No. _____

Receiver ID _____

NOTE: This owner's manual may be used with several different models. Not all features (or drawings) discussed in this manual will necessarily match those found with your system. This is normal and does not require you contacting your dealer or requesting service.

DIRECTV programming sold separately. ACTIVATION OF PROGRAMMING MAY BE SUBJECT TO CREDIT APPROVAL AND REQUIRES VALID SERVICE ADDRESS, SOCIAL SECURITY NUMBER AND/OR MAJOR CREDIT CARD. DEPOSIT OR PREPAYMENT MAY BE REQUIRED. Programming subject to change. DIRECTV service not available outside the U.S. DIRECTV programming is sold separately and independently of DIRECTV System hardware. A valid programming subscription is required to operate DIRECTV System hardware. Activate your DIRECTV programming today at 1-800-DIRECTV (1-800-347-3288)

© 2004 DIRECTV, Inc. DIRECTV, the Cyclone Design logo and Advanced Program Guide are registered trademarks of DIRECTV, Inc. All other trademarks and service marks are the property of their respective owners.

This product includes software developed by the University of California, Berkeley and its contributors. Copyright © 1982, 1986, 1988, 1990, 1993 The Regents of the University of California. All rights reserved.

Redistribution and use in source and binary forms, with or without modification, are permitted provided that the following conditions are met:

1. Redistribution of source code must retain the above copyright notice, this list of conditions and the following disclaimer.
2. Redistribution in binary form must reproduce the above copyright notice, this list of conditions and the following disclaimer in the documentation and/or other materials provided with the distribution.
3. All advertising materials mentioning features or use of this software must display the following acknowledgment: This product includes software developed by the University of California, Berkeley and its contributors.
4. Neither the name of the University nor the names of its contributors may be used to endorse or promote products derived from this software without specific prior written permission.

THIS SOFTWARE IS PROVIDED BY THE REGENTS AND CONTRIBUTORS "AS IS" AND ANY EXPRESS OR IMPLIED WARRANTIES, INCLUDING, BUT NOT LIMITED TO, THE IMPLIED WARRANTIES OF MERCHANTABILITY AND FITNESS FOR A PARTICULAR PURPOSE ARE DISCLAIMED. IN NO EVENT SHALL THE REGENTS OR CONTRIBUTORS BE LIABLE FOR ANY DIRECT, INDIRECT, INCIDENTAL, SPECIAL, EXEMPLARY, OR CONSEQUENTIAL DAMAGES (INCLUDING, BUT NOT LIMITED TO, PROCUREMENT OF SUBSTITUTE GOODS OR SERVICES; LOSS OF USE, DATA, OR PROFITS; OR BUSINESS INTERRUPTION) HOWEVER CAUSED AND ON ANY THEORY OF LIABILITY, WHETHER IN CONTRACT, STRICT LIABILITY, OR TORT (INCLUDING NEGLIGENCE OR OTHERWISE) ARISING IN ANY WAY OUT OF THE USE OF THIS SOFTWARE, EVEN IF ADVISED OF THE POSSIBILITY OF SUCH DAMAGE.

The software included in this product is based in part on the work of the Independent JPEG-Group and on the PNG Reference Library which is copyright © 1998-2001 Glenn Randers-Pehrson, copyright © 1996, 1997 Andreas Dilger, and copyright © 1995, 1996 Guy Eric Schalnat, Group 42, Inc.

Safety Instructions - Read Before Operating Equipment

Important Safety Instructions:

- 1 - Read these instructions.
- 2 - Keep these instructions.
- 3 - Heed all warnings.
- 4 - Follow all instructions.
- 5 - Do not use this apparatus near water.
- 6 - Clean only with dry cloth.
- 7 - Do not block any ventilation openings. Leave minimum distances around the apparatus. Do not cover ventilation openings with items, such as newspapers, table clothes, curtains, etc.
- 8 - Do not install near any heat sources such as radiators, heat registers, stoves, or other apparatus (including amplifiers) that produce heat. No naked flame sources, such as candles, should be placed on the apparatus.
- 9 - This apparatus shall not be exposed to dripping or splashing and no objects filled with liquids, such as vases, shall be placed on the apparatus.
- 10 - Do not defeat the safety purpose of the polarized or grounding-type plug. A polarized plug has two blades with one wider than the other. A grounding type plug has two blades and a third grounding prong. The wide blade or the third prong are provided for your safety. If the provided plug does not fit into your outlet, consult an electrician for replacement of the obsolete outlet.
- 11 - Protect the power cord from being walked on or pinched particularly at plugs, convenience receptacles, and the point where they exit from the apparatus.
- 12 - Only use attachments/accessories specified by the manufacturer.
- 13 -  Use only with the cart, stand, tripod, bracket, or table specified by the manufacturer, or sold with the apparatus. When a cart is used, use caution when moving the cart/apparatus combination to avoid injury from tipover.
- 14 - Unplug this apparatus during lightning storms or when unused for long periods of time.
- 15 - Refer all servicing to qualified service personnel. Servicing is required when the apparatus has been damaged in any way, such as power-supply cord or plug is damaged, liquid has been spilled or objects have fallen into the apparatus, the apparatus has been exposed to rain or moisture, does not operate normally, or has been dropped.
- 16 - Leave accessible the mains connector at the back of the unit in case of emergency shutdown.

Safety Instructions (cont'd), General Information

This device incorporates an anticopy process technology that is protected by U.S. patents and other intellectual property rights. The anticopy process is licensed for non-commercial, home use only. Reverse engineering or disassembly is prohibited.

NOTE TO CATV SYSTEM INSTALLER

Article 820-40 of the NEC (National Electrical Code) provides guidelines for proper grounding and, in particular, specifies that the cable ground shall be connected to the grounding system of the building, as close to the point cable entry as practical.

WARNING

This device complies with Part 15 of the FCC Rules.

Operation is subject to the following two conditions:

- (1) This device may not cause harmful interference, and
- (2) This device must accept any interference received, including interference that may cause undesired operation.

FCC Regulations and Information

This equipment has been tested and found to comply with the limits for a Class B digital device, pursuant to Part 15 of the FCC Rules. These limits are designed to provide reasonable protection against harmful interference in a residential installation. This equipment generates, uses and can radiate radio frequency energy and, if not installed and used in accordance with the instructions, may cause harmful interference to radio communications.

However, there is no guarantee that interference will not occur in a particular installation. If this equipment does cause harmful interference to radio or television reception (which you can determine by turning the equipment off and on), you are encouraged to try to correct the interference by one or more of the following measures:

Reorient or relocate the receiving satellite dish antenna.

Increase the separation between the equipment and receiver.

Connect the equipment into an outlet on a circuit different from that to which the receiver is connected.

Consult the dealer or an experienced radio/TV technician for help.

IMPORTANT

Any changes or modifications to the equipment by the user not expressly approved by the warranty or manufacturer could void the user's authority to operate the equipment.

Domestic use U. S.A – For units used at 120V, use only the power supply cord which is supplied with the product.

ANALOG DEVICE WARNINGS

Federal Communication Commission (FCC) Part 68 and Administrative Council for Terminal Attachments (ACTA)

This device complies with Part 68 of the FCC rules and the requirements adopted by the ACTA. A label on the bottom panel of this equipment contains, among other information, a product identifier in the format US : AAAEQ##TXXXX. If requested, this number must be provided to the telephone company. The REN is used to determine the number of devices that may be connected to a telephone line. Excessive RENs on the telephone line may result in the devices not ringing in response to an incoming call. In most, but not all areas, the sum of RENs should not exceed five (5.0). To be certain of the number of devices that may be connected to a line, as determined by the total RENs, contact the local telephone company.

The REN for this product is part of the product identifier that has the format US : AAAEQ##TXXXX. The digits represented by ## are the REN without a decimal point. For the receiver, 0.1 means a REN of 0.1. Note: RENs are associated with loop-start and ground-start ports. Do not use for E & M or digital ports.

This equipment uses the following USOC jack: RJ-11C. No modular plug is provided with this equipment.

A plug and jack used to connect the receiver to the premises wiring and telephone network must comply with the applicable FCC Part 68 rules and requirements adopted by ACTA. A compliant telephone cord is provided with this product. It is designed to be connected to a compatible modular jack that is also compliant. See installation instruction for details.

If the receiver causes harm to the telephone network, the telephone company will notify you in advance that temporary discontinuance of service may be required. But if advance notice isn't practical, the telephone company will notify the customer as soon as possible. Also, you will be advised of your right to file a complaint with the FCC if you believe it is necessary. The telephone company may make changes in its facilities, equipment, operations or procedures that could affect the operation of the equipment. If this happens the telephone company will provide advance notice in order for you to make necessary modifications to maintain uninterrupted service. If the equipment is causing harm to the telephone network, the telephone company may request that you disconnect the equipment until the problem is resolved.

This equipment is of a type that is not intended to be repaired by the user.

This equipment cannot be used on public coin phone service provided by the telephone company. Connection to party line service is subject to state tariffs. Contact the state public utility commission, public service commission or corporation for information. If your home has specially wired alarm equipment connected to the telephone line, ensure the installation of this receiver does not disable your alarm equipment. If you have questions about what will disable alarm equipment, consult your telephone company or a qualified installer.

We recommend the installation of an AC surge arrester in the AC outlet to which this equipment is connected. Telephone companies report that electrical surges, typically lightning transients, are very destructive to customer terminal equipment connected to AC power sources.

If trouble is experienced with the receiver, for repair or warranty information, please call: 1-800-347-3288.

Contents

Package Contents	6	Main Menu	
Front and Rear Panels	7	Using the Main Menu	24
Access Card	8	Preferences	25
Connections		Preferred Language	25
Antenna and Phone	9	Screen Format	25
TV	10	Banner Duration.....	26
Audio	11	Parental Controls	27
VCR/DVD recorder.....	12	Lock the System	27
Remote Control Use.....	13-16	Channel Locks.....	27
Setup Wizard	17	Set Spending Limit.....	28
Watching TV	18	Set Rating Limit	28
Enhanced User Features		Replace Access Card	28
Favorite Channels	19	Purchases	29
Program Guide		Setup	30-31
DIRECTV ADVANCED PROGRAM GUIDE®		System Upgrades	31
.....	20-21	Messages	32
Reminders	21	Caller ID	32
PPV (Pay Per View).....	21	Troubleshooting.....	33
Guide Menu	22-23	Technical specifications.....	34
		Limited Warranty	35
		Protection Plan	Back cover

Package Contents



DIRECTV® Receiver



Infrared (IR) Universal Remote Control with two AA Batteries



User Guide



Power Supply Cord

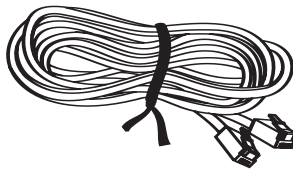

RJ-11 Telephone Cord



Access Card

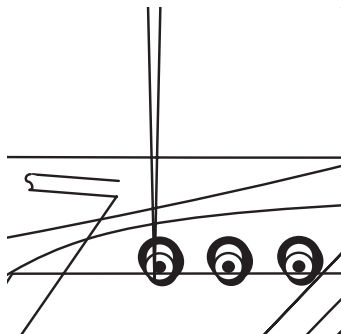

RCA Type Audio/Video Connecting Cable

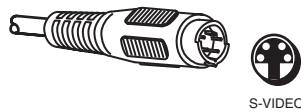

S-Video Connecting Cable

Front and Rear Panels

Front Panel



Power indicator
Lights when the DIRECTV Receiver is on.

POWER button
Turns the DIRECTV® Receiver on or puts it in Standby.

Guide button
Displays Program Guide.

MENU button
Displays the Main Menu.

Info button
Switches between program information in the banner and the program details screen.

Active button
For future use.

SELECT button
Confirms a selection.

Arrow buttons (◀▶▲▼)
Navigates through the Guide and menus. While watching Satellite programming, use the ▲▼ arrows to channel up or down.

Rear Panel

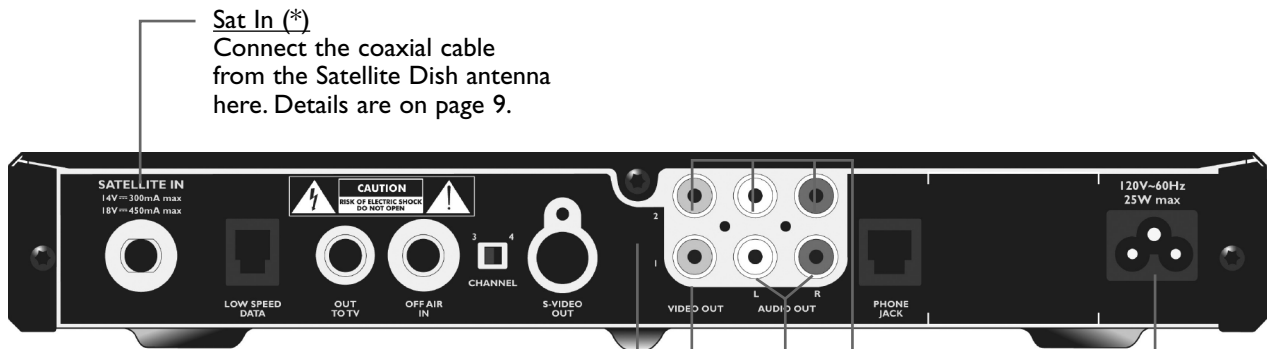

Sat In (*)
Connect the coaxial cable from the Satellite Dish antenna here. Details are on page 9.

TV/VCR Output (*)
Antenna Input (*)
Connect to an off-air antenna or analog cable system.
Channel 3/4 switch : Details on page 10.
S-Video Output (*)
Component Video Output (*)

Video output 1
Left/right Audio output 1
Secondary Audio/Video Outputs

AC power input (*)**
Connect the supplied power cord here.

Phone jack ()**
Connect the supplied phone cord here and to a wall phone jack in your home.

(*) SELV: Safety Extra Low Voltage
(**) TNV3: Telecommunication Network Voltage
(***) HV: Hazardous Voltage

Note : The identification sticker can be located underneath your receiver.

Access Card



The access card provided with your system includes information about your purchase authorization and other data. To watch channels, your viewing access card needs to be inserted in the access card slot on the front of your DIRECTV® Receiver.

The access card needs to be inserted during system setup and generally does not need to be removed. Each access card has a unique number. Be sure to record this number in the space provided on the second page of this manual in the “For Customer Use” section for future reference.

1. Open the flip-down door on the front of the DIRECTV Receiver.
2. Gently insert the access card into the slot, following instructions on the card, until it meets the stop. Do not use undue force. The end should be visible outside the slot.
3. Keep your access card permanently inserted in your DIRECTV Receiver.

If you have to reinsert the card, follow the instructions on the card, making sure the gold chip is facing down.

 Caution	
<ul style="list-style-type: none">• YOUR ACCESS CARD IS FRAGILE.• ALWAYS INSERT CORRECTLY AND CAREFULLY.• DO NOT BEND.• DO NOT REMOVE AND RE-INSERT UNNECESSARILY.• NEVER SUBMERGE IN LIQUID OR APPLY CLEANING FLUIDS.	



RESET button
Resets the receiver.

Connections

Antenna and Phone

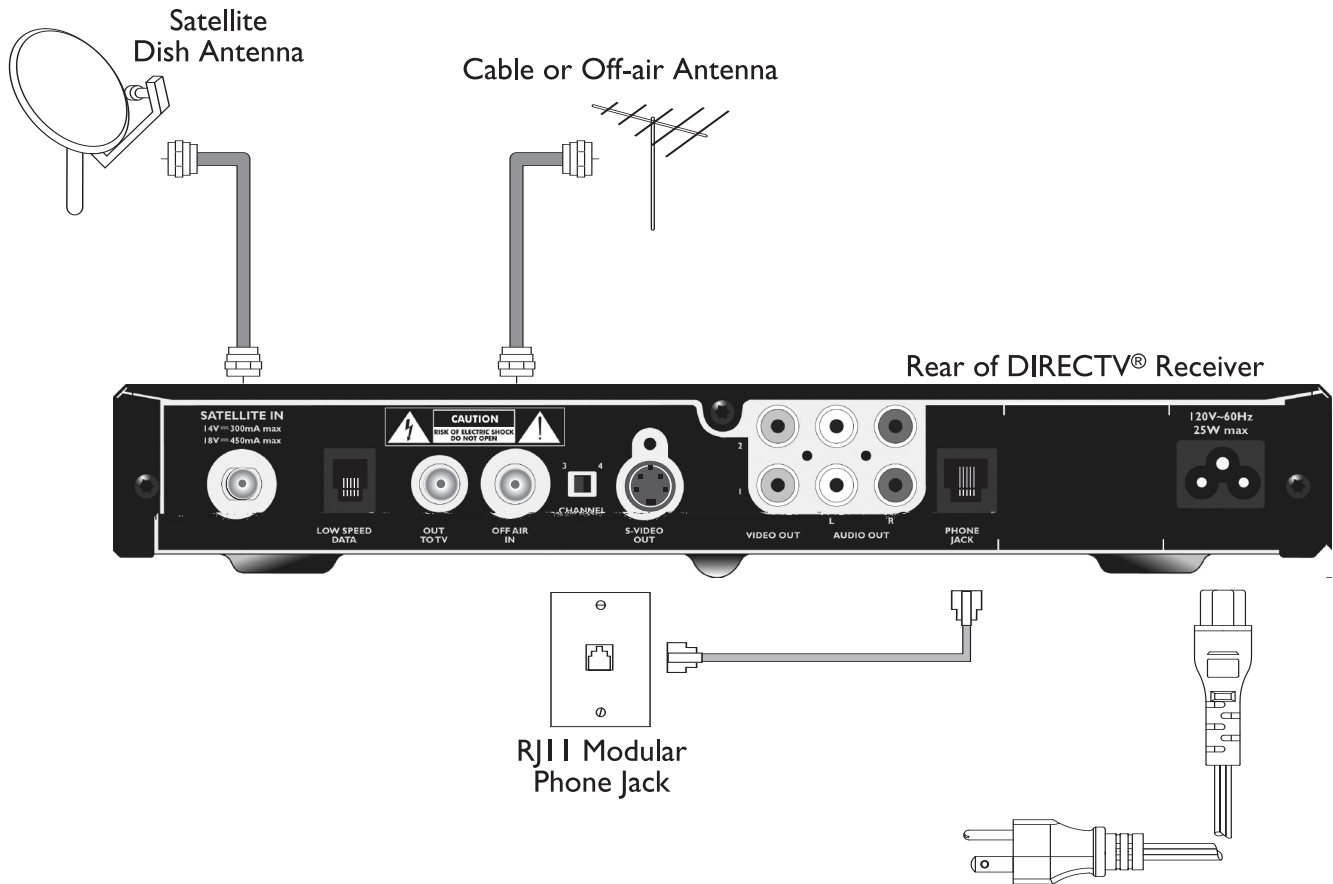

Unplug all equipment from the AC outlet before making connections.

- 1- Connect the RF coaxial cable from the satellite dish to the SAT IN connector.
- 2- If you have cable (CATV) or an off-air antenna, connect its RF coaxial cable to the OFF AIR IN connector
- 3- Using the telephone cord (supplied), connect one end of it to a phone jack in your home. Connect the other end to the PHONE JACK input on the rear of the Receiver. To enjoy uninterrupted programming and to order pay per view programs, the DIRECTV® Receiver must be continuously connected to a land-based phone line.
- 4- Connect one end of the AC power cord (supplied) to the Receiver's AC IN plug.
- 5- Do not plug your DIRECTV Receiver to the mains power outlet until all connections are done.

Connections (cont'd)

TV

Unplug all equipment from the AC outlet before making connections.

There are several options for connecting the video and audio outputs of your DIRECTV® Receiver, depending on the type of equipment you want to connect and the quality of signal you want to achieve. The following chart summarizes your options for video connections. Select either A, B, or C and refer to the illustration and steps below to connect.

Option	Video Signal Quality	Video Output
A	Very Good	S-VIDEO OUT
B	Good	VIDEO OUT 1
C	Standard	RF - OUT to TV

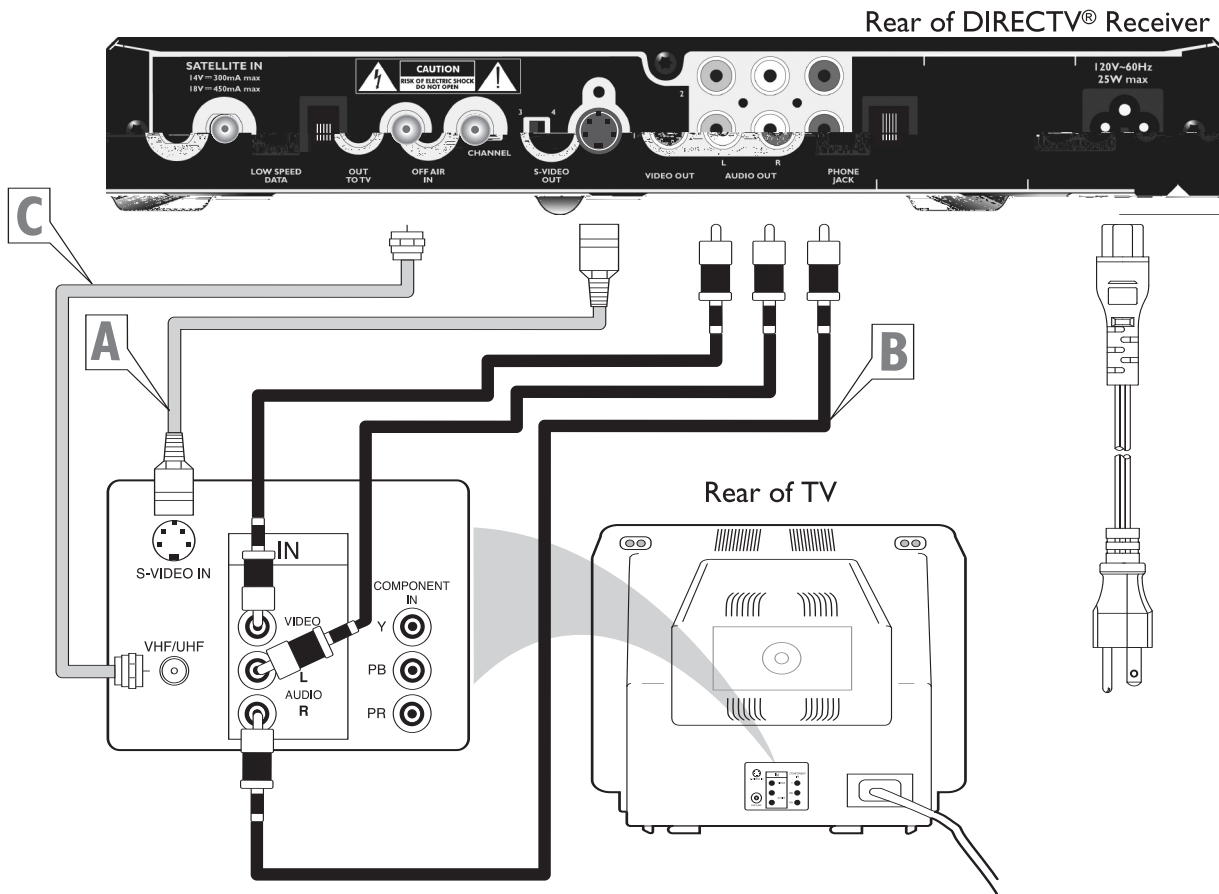

Note : The TV rear panel shown above has jacks for all possible connections. Your TV's rear panel may differ.

- A.** Using a S-VIDEO cable (supplied), connect one end to the S-VIDEO connector on the Receiver to the S-VIDEO IN on the TV. Select the proper input on your TV.
- B.** Using the RCA type cable (supplied), connect one end to the OUT 1 VIDEO jack (yellow) on the Receiver to the VIDEO IN on the TV. Select the proper input on your TV.
- C.** Using the RF coaxial cable (not supplied), connect one end to the OUT TO TV connector on the Receiver to the RF IN jack on the TV. Turn the TV on and select channel 3 or 4, whichever is not used or least used in your area. Set the CHANNEL switch on the back of the Receiver to the same channel.

Note : If only one plug is connected on either left or right mono audio output will be delivered by your DIRECTV® receiver

Connections (cont'd)

Audio

Unplug all equipment from the AC outlet before making connections.

There are several options for connecting the audio outputs of your DIRECTV® Receiver; depending on the type of equipment you want to connect. The following chart summarizes your additional options for audio connections. Refer to the illustration and steps below to connect.

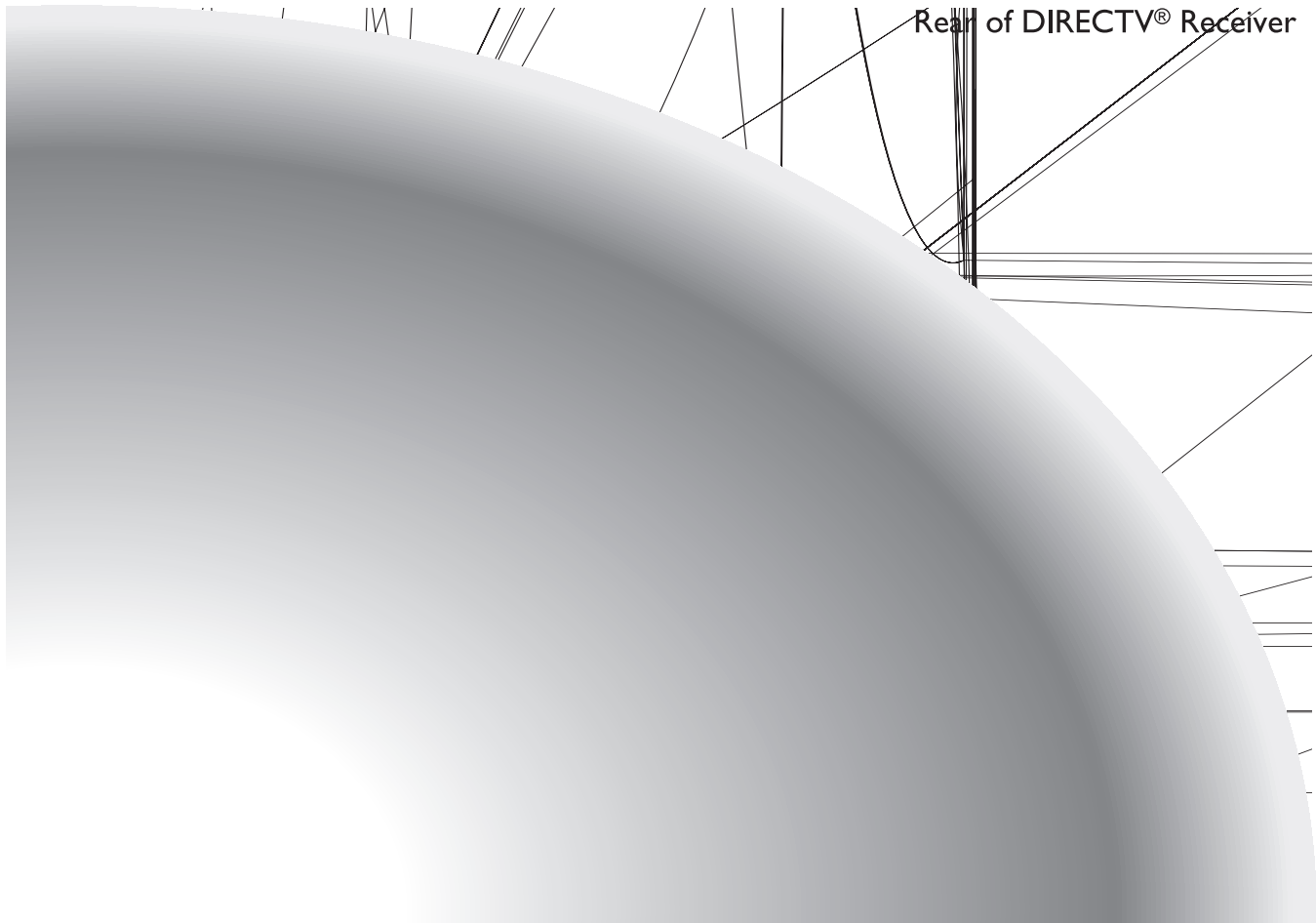

Note : This illustration shows a home theater stereo receiver and TV rear panel for possible connections. Your home theater system stereo receiver or TV rear jack panel may differ.

Using the RCA type cable (supplied), connect the left (white) and right (red) jacks of one end of the cables to the AUDIO OUT 1 LEFT and RIGHT connectors on the Receiver and the other ends to the left and right AUDIO IN on the home theater stereo receiver or TV. Select the proper input on the home theater stereo receiver or TV.

Connections (cont'd)

VCR/DVD recorder

Unplug all equipment from the AC outlet before making connections.

To record satellite programming, connect the VIDEO OUT 1 and AUDIO LEFT and RIGHT OUT 1 on the rear of the DIRECTV Receiver to the corresponding video and audio inputs on the VCR. These outputs always output satellite programming. Alternatively, you can connect OUT TO TV RF output to the RF input on the VCR.

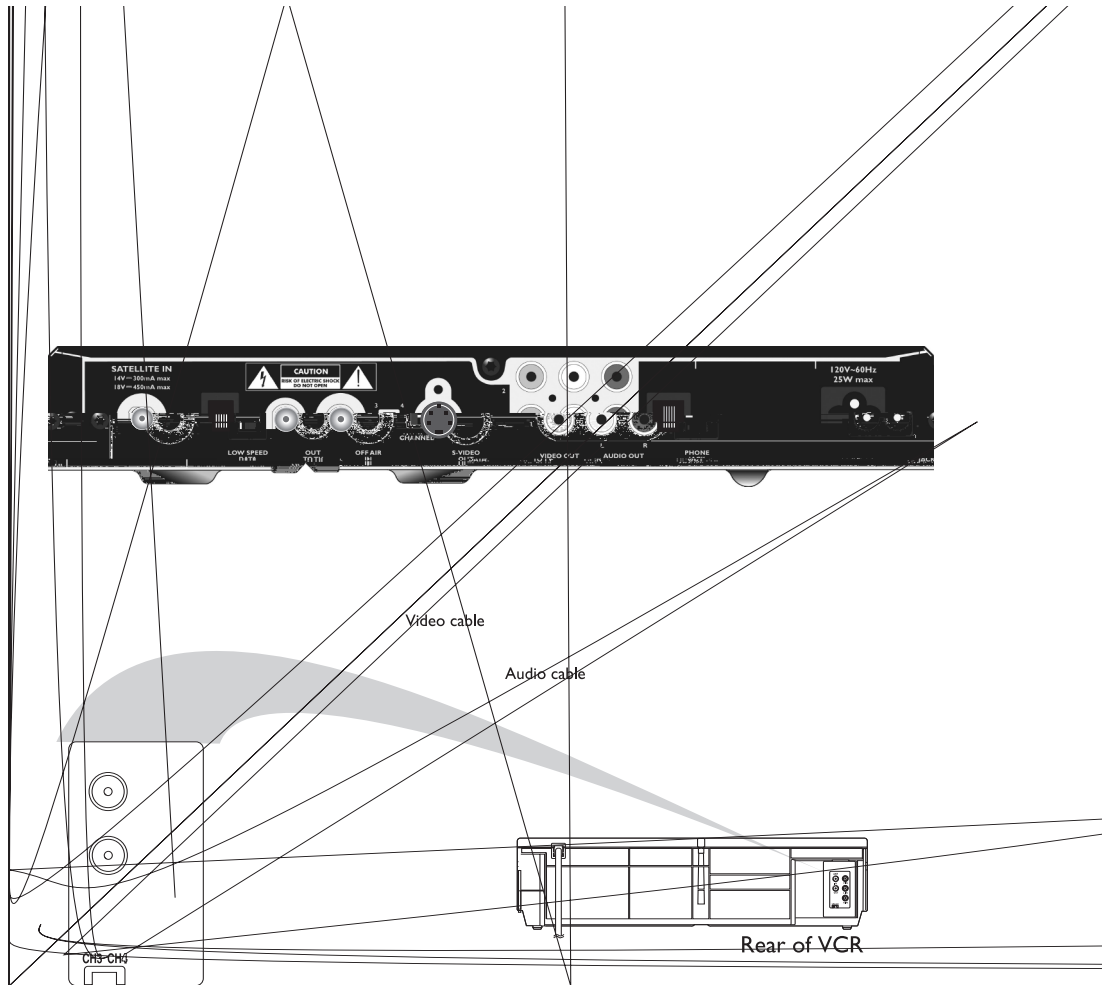

Note:

Remote Control

Preparing Your Remote Control

Battery Installation

1. Remove the battery compartment cover. Insert the two batteries (type/AA) supplied.
2. Position them in the battery compartment, as shown in the diagram.
3. Replace the cover.

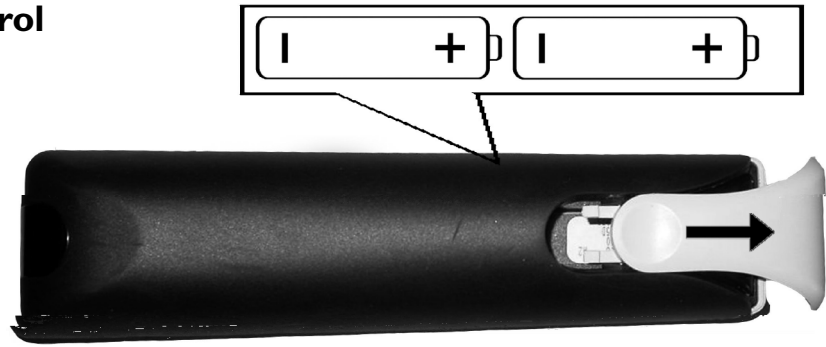

Satellite Functions

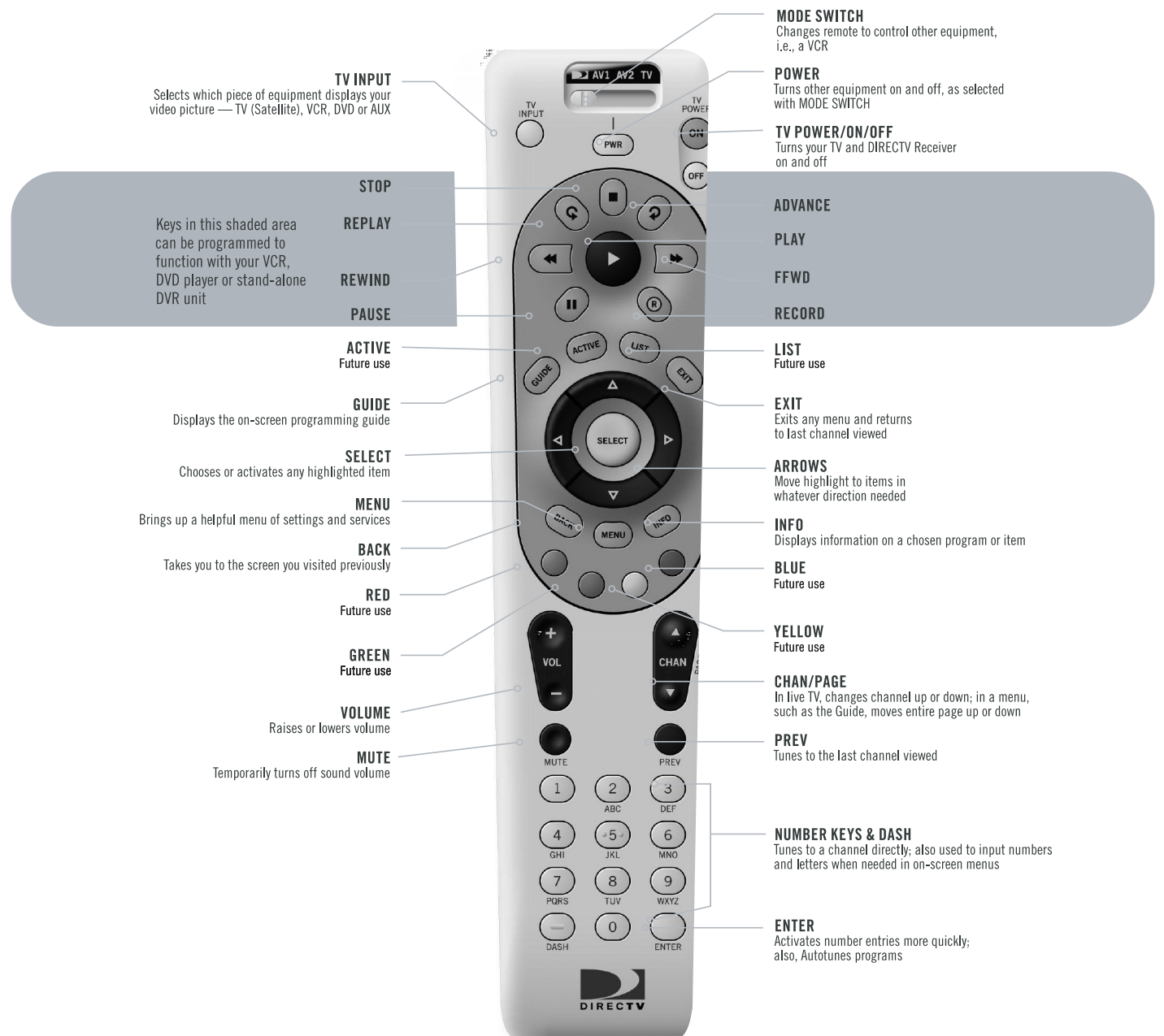

Remote Control (cont'd)

Programming Your Remote Control

TV Setup (TV Power, VOL and MUTE)

You can program the DIRECTV remote control to operate your TV power, volume and mute.

- 1) Move the slide switch near the top of the remote to TV.
- 2) Point the remote away from your DIRECTV Receiver. Press and hold MUTE and SELECT until the light near the slide switch on the remote flashes twice (about 5 seconds).
- 3) Enter the five-digit code for your TV (refer to the code list next page).
- 4) Test the remote by pressing the PWR, VOL and MUTE. If the remote does not control your television, repeat steps 2 and 3, using a different five-digit code.
- 5) If you've tried all the codes for your TV, and you can't control your TV, then try Perform a Code Search

Once your remote is programmed to work with your TV, the VOL and MUTE key will work regardless of the slide switch position. If you would like to change the VOL and MUTE to work with another component, you can. Simply set up your remote to work with the component, and then follow the Volume Lock instructions.

TV INPUT Select setup

Once you've set up your TV Power, VOL and MUTE, you can program the TV INPUT button if you'd like.

- 1) Move the slide switch near the top of the remote to TV.
- 2) Point the remote away from your DIRECTV Receiver. Press and hold MUTE and SELECT until the light near the slide switch on the remote flashes twice. (about 5 seconds)
- 3) Enter 9 - 6 - 0. The light will blink twice.

If you want to hide the TV INPUT button, then follow steps 1 through 3 again, and the light will blink 4 times, then pressing the TV INPUT will do nothing.

Set up AV1 or AV2 to control DVD, VCR, other TV, second DIRECTV Receiver, or Stereo

You can program the remote control to work with other electronic components in your home.

- 1) Move the slide switch near the top of the remote control to AV1 or AV2
- 2) Point the remote away from your DIRECTV Receiver and components. Press and hold MUTE and SELECT until the light near the slide switch on the remote flashes twice. (about 5 seconds)
- 3) Enter the five-digit code for the component and brand (refer to the code list located next page)
- 4) Test the remote by pressing the PWR button on the remote. If the component turns off/on then you successfully programmed your remote. If not then repeat step 1 with the next code for your component.
- 5) If you've tried all the codes for component, and you can control your equipment, then try Perform a Code Search

Volume Lock

If you programmed your remote to control your TV, then the VOL and MUTE key will automatically control the volume on your TV, regardless of the slide switch position. If you want the VOL/MUTE

keys to control a different component, such as your stereo, you can.

- 1) First, program AV1 or AV2 to work with your stereo or A/V equipment (see above instructions).
- 2) Move the slide switch near the top of the remote control to the position you would like to lock the VOL & MUTE keys to.
- 3) Point to remote away from your DIRECTV Receiver and components. Press and hold MUTE and SELECT until the light near the slide switch on the remote flashes twice (about 5 seconds).
- 4) Enter 9 - 9 - 3. The light will blink twice.

Now no matter which position your slide switch is in, the VOL and MUTE will work this new component.

Global Volume Unlock

Depending on how you set up your remote, the VOL and MUTE will control only your TV or other component, no matter which position the switch is in. If you don't want it to work this way, the remote can be programmed so that the VOL and MUTE work with multiple components based on the switch position.

- 1) Point the remote away from your DIRECTV Receiver and components. Press and hold MUTE and SELECT until the light near the slide switch on the remote flashes twice (about 5 seconds).
- 2) Enter 9 - 9 - 3 then VOL UP. The light will blink twice.

Now the VOL and MUTE will work for the component selected by the slide switch position.

Perform a Code Search

If you were unable to find a code for your brand of TV or component, you can try a code search. This process may take up to 30 minutes.

- 1) First turn on the TV or component.
- 2) Move the slide switch near the top of the remote control to the appropriate position.
- 3) Point the remote away from your DIRECTV Receiver and components. Press and hold MUTE and SELECT until the light near the slide switch on the remote flashes twice (about 5 seconds).
- 4) Enter one of the following 4 digits

TV: 9 9 | 1 VCR or DVD: 9 9 | 2 Stereo: 9 9 | 3

- 5) Press the PWR key on the remote control.
- 6) Point the remote to the TV or component and press CHAN UP. Repeatedly press the CHAN UP until the TV or component turns off.
- 7) When the TV or component turns off, the press SELECT.

Note: If the light flashes 3 times before the TV or component responds, then you've cycled all codes and unfortunately the code you need is not available. You must then use the remote that came with your TV or component.

Factory Default

To reset all the functions of the remote control to the factory defaults, follow these steps:

- 1) Point the remote away from your DIRECTV Receiver and components. Press and hold MUTE and SELECT until the light near the slide switch on the remote flashes twice (about 5 seconds).
- 2) Enter 9-8-1. The light on the remote will flash twice.

Now you have cleared the AV1, AV2 and TV modes.

Remote Control (cont'd)

TV Codes

Admiral	10093, 10463	Envision	10030	Minutz	10021	Scott	10178
Advent	10761, 10783, 10842	Fisher	10154	Mitsubishi	10093, 10150, 11250, 10178	Scott	10236, 10180, 10178, 10179
Aiko	10092	Fujitsu	10179, 10809, 10683, 10853	Monivision	10843, 10700	Sears	10047, 10054, 10154, 10156, 10178
Akai	10702, 10030, 10672	Funai	10180, 10171, 10179	Motorola	10093		10171, 10056, 10179
Alaron	10179	Futuretech	10180	MTC	10060, 10030, 10056	Sharp	10093, 10818, 10689, 10688, 10851
Albatron	10843, 10700	Gateway	11756, 11755	Multitech	10180	Sheng Chia	10093
Ambassador	10177	GE	10047, 10051, 10451, 10178, 10021	NAD	10156, 10178, 10866	Signature	10016
America Action	10180	Gibraltar	10017, 10030	NEC	10030, 11704, 10056, 10704	Sony	10000, 10834
Ampro	10751	GoldStar	10030, 10178	Nikko	10030, 10178, 10092	Soundesign	10180, 10178, 10179
Anam	10180	Grundy	10180, 10179	Norcent	10748, 10824	Squareview	10171
AOC	10030	Hallmark	10178	NTC	10092	SSS	10180
Apex Digital	10748, 10765	Harley Davidson	10179	Onwa	10180	Starlite	10180
Audiovox	10451, 10180, 10092	Harman/Kardon	10054	Optimus	10154, 10250, 10166, 10650	Supreme	10000
Bell & Howell	10154, 10016	Harvard	10180	Optonica	10093	SVA	10748
Bradford	10180	Havermy	10093	Orion	10236, 10463, 10179	Sylvania	10054, 10030, 10171
Broksonic	10236, 10463	Hello Kitty	10451	Panasonic	10250, 10051, 10650	Symphonic	10180, 10171
Candle	10030, 10056	Himitsu	10180	Penney	10047, 10156, 10051, 10060	Tandy	10093
Carnivale	10030	Hisense	10748		10030, 10178, 10021	Technics	10250, 10051
Carver	10054	Hitachi	10145, 10016, 10151, 10056	Philco	10054, 10030	Technol Ace	10179
Celebrity	10000	Infinity	10054	Philips	10054, 10690	Techwood	10051, 10056
Celera	10765	Inteq	10017	Pilot	10030	Teknika	10054, 10180, 10150, 10060
Changhong	10765	JBL	10054	Pioneer	10166, 10866, 10679		10092, 10016, 10179, 10056
Citizen	10060, 10030, 10056, 10092	CB	10000	Portland	10092	Telefunken	10702, 10056
Clarion	10180	Jensen	10761	Prima	10761, 10783	TMK	10178, 10056, 10177
Concerto	10056	JVC	10053	Princeton	10700	TNCi	10017
Contec	10180	KEC	10180	Prism	10051	Toshiba	10154, 10156, 10060, 10650
Craig	10180	Kenwood	10030	Proscan	10047		11704, 10845
Crosley	10054	KLH	10765	Proton	10178, 10466	TVS	10463
Crown	10180	KTV	10180, 10030	Pulsar	10017	Vector Research	10030
Curtis Mathes	10047, 10054, 10154	Logik	10016	Quasar	10250, 10051, 10650	Victor	10053
	10451, 10093, 10060, 10702, 10030	Luxman	10056	RadioShack	10047, 10154, 10180, 10030	Vidikron	10054
	10145, 10166, 10056, 10016, 10466	LXI	10047, 10054, 10154, 10156, 10178		10178, 10056	Vidtech	10178
CXC	10180	Magnavox	10054, 10030, 10706, 10179	RCA	10047, 10090, 10679	Viewsonic	11755
Daewoo	10451, 11661, 10672, 10092	Majestic	10016	Realistic	10154, 10180, 10030, 10178	Wards	10054, 10030, 10178, 10866
Denon	10145	Marantz	10054, 10030	Runco	10017, 10030, 10603		10016, 10179, 10021, 10056
Dumont	10017	Matsushita	10250, 10650	Sampo	10030, 11755	Waycon	10156
Durabrand	10180, 10178	Megatron	10178, 10145	Samsung	10060, 10702, 10030, 10178	White Westinghouse	10463
Dwin	10774, 10720	Memorex	10154, 10250, 10463, 10150		10814, 10766, 10056	Yamaha	10030
Electroband	10000	MGA	10178, 10179, 10016	Sansui	10056	Zenith	10017, 10463, 10178, 10092
Emerson	10154, 10236, 10463, 10180	Midland	10150, 10030, 10178	Sanyo	10463		10016
	10178, 10171, 10179, 10177		10047, 10017, 10051		10154		

VCR Codes

Admiral	20048, 20209	Go Video	20807	Nikko	20037	Sears	20035, 20037, 20047, 20000
Adventura	20000		20432	Noblex	20240		20042, 20104, 21237
Aiko	20278	GoldStar	20037, 20038, 21237	Olympus	20035	Sharp	20048, 20807
Aiwa	20037, 20000	Gradiente	20000	Optimus	21062, 20162, 20037, 20048	Shintom	20072
America Action	20278	Harley Davidson	20000		20104, 20432	Shogun	20240
American High	20035	Harman/Kardon	20081, 20038	Orion	20184, 20209, 20002, 21479	Singer	20072
Asha	20240	Harwood	20072	Panasonic	21062, 20035, 20162, 20616	Sonic Blue	20616
Audiovox	20037, 20278	Hi-Q	20047		20225, 21035	Sony	20035, 20032, 20033, 20000, 21232
Beaumont	20240	Hitachi	20000, 20042	Penney	20035, 20037, 20240, 20042		20636
Bell & Howell	20104	Hughes Network Systems	20042		20038, 21237, 21035	STS	20042
Broksonic	20184, 20121, 20209, 20002	JVC	20067	Pentax	20042	Sylvania	20035, 20081, 20000, 20043
	21479, 20479	KEC	20037, 20278		20042		21781
Calix	20037	Kenwood	20067, 20038	Philco	20035	Symphonic	20000
Canon	20035	KLH	20072	Philips	20035, 20081, 20618	Teac	20000
Carver	20081	Kodak	20035, 20037	Pilot	20037	Technics	20035, 20162
CCE	20072, 20278	Lloyd's	20000	Pioneer	20067	Teknika	20035, 20037, 20000
Citizen	20037, 20278, 21278	Logik	20072	Polk Audio	20081	Thomas	20000
Colt	20072	LXI	20037	Profitronic	20240	Tivo	20636, 20618
Craig	20037, 20047, 20240, 20072	Magnasonic	21278	Proscan	20060, 21060	TMK	20240
Curtis Mathes	20060, 20035, 20162	Magnavox	20035, 20039, 20081, 20000	Protec	20072	Toshiba	20045, 20043, 21145
	21035		21781	Pulsar	20039	Totevision	20037, 20240
Cybernax	20240	Magnin	20240	Quasar	20035, 20162, 21035	Unitech	20240
Daewoo	20045, 20278, 21278	Marantz	20035, 20081	RadioShack	20000	Vector	20045
Denon	20042	Marta	20037	Radix	20037	Vector Research	20038
Durabrand	20039, 20038	Matsushita	20035, 20162	Randex	20037	Video Concepts	20045
Dynatech	20000	MEI	20035	RCA	20060, 20240, 20042, 20807, 21060	Videomagic	20037
Electrohome	20037	Memorex	20035, 20162, 20037, 20048	Realistic	21035, 20880	Videosonic	20240
Electrohome	20037		20039, 20047, 20240, 20000, 20104		20000, 20104	Villain	20000
Emerex	20032	MGA	20209, 20479, 21237	ReplayTV	20616	Wards	20060, 20035, 20048, 20047
Emerson	20037, 20184, 20000, 20121	MGN Technology	20240, 20043	Runco	20039		20081, 20240, 20000, 20042, 20072
	20043, 20209, 20002, 20278, 21278	Minolta	20042	Samsung	20240, 20045, 21014	White Westinghouse	20209, 20072
	20479, 21479	Mitsubishi	20067, 20043, 20807	Sanky	20048, 20039	XR-1000	20035, 20000, 20072
Fisher	20047, 20104	Motorola	20035, 20048	Sansui	20000, 20067, 20209, 21479	Yamaha	20039, 20033, 20000, 20209
Fuji	20035, 20033	MTC	20240, 20000		20479	Zenith	20479, 21479
Funai	20000	Multitech	20000, 20072	Sanyo	20047, 20240, 20104		
Garrard	20000	NEC	20104, 20067, 20038	Scott	20184, 20045, 20121, 20043		
GE	20060, 20035, 20240, 21060, 21035						

DVD Codes

Allegro	20869	Go Video	20783, 20715	Norcent	21003	Sonic Blue	20869
Apex Digital	20672, 20717, 21100	Greenhill	20717	Onkyo	20503	Sony	20533, 20864, 21033
	20794, 21061, 20755, 20830, 20796	Hitachi	20664	Oritron	20651	Sylvania	20821, 20675
Blaupunkt	20717	Hiteker	20672	Panasonic	20490, 21362	Symphonic	20675
Blue Parade	20571	Initial	20717	Philips	20503, 20539, 20646, 20854	Technics	20490
Broksonic	20695	JVC	20558, 20623, 20867	Pioneer	20525, 20571	Theta Digital	20571
CineVision	20876	Kenwood	20490, 20534	Polk Audio	20539	Toshiba	20503, 21045, 20695
Curtis Mathes	21087	KLH	20717, 21020	Proscan	20522	Urban Concepts	20503
CyberHome	20816, 21023	Koss	20651	Qwestar	20651	Xbox	20522
Daewoo	20784, 20798	Lasonic	20798	RCA	20522, 20571, 20717, 21022, 20822	Yamaha	20490, 20539, 20545
Denon	20490	Magnavox	20503, 20675	Rio	20869	Zenith	20503, 20591, 20869
DVD2000	20521	Marantz	20539	Rotel	20623		
Emerson	20591, 20675, 20821	Memorex	20695	Samsung	20573, 20820		
Enterprise	20591	Microsoft	20522	Sansui	20695		
Fisher	20670	Mintek	20839, 20717	Sanyo	20670, 20695		
Funai	20675	Mitsubishi	21521, 20521	Sharp	20630		
GE	20522, 20815, 20717	Nesa	20717	Shinsonic	20533, 20839		

Remote Control (cont'd)

TV Functions

Once programmed (refer to page 14), your DIRECTV® Remote Control should control certain functions of your TV. Be sure to press the TV button before operating your TV.

TV

Move to position TV to put the remote control in TV mode. LED will blink when other buttons are pressed while in TV mode.

TV INPUT

Switch through TV inputs (if applicable).

VOL +/-

Increases and decreases volume.

MUTE

Switches audio on and off

0-9

Allows direct number entry for tuning to a channel.

TV POWER ON

Press to turn TV on.

TV POWER OFF

Press to turn TV off.

CH+/CH-

Change channel up or down



Note: All features on your TV may not be supported by this remote.

Setup Wizard

If your equipment has been professionally installed, skip this first time setup section and go to page 18.

After the DIRECTV® Receiver has been connected to your components, it is time to turn the DIRECTV Receiver on.

1. Press the PWR button on the remote control.
2. Use the ▲▼ buttons to select your preferred language of the on screen menus and guide and press SELECT.
3. When the Welcome screen displays, press the SELECT button on the remote control to start the Setup Wizard. The Setup Wizard is a first time setup that automatically steps you through the installation process. This screen will **ONLY** appear the very first time your DIRECTV Receiver is turned on.
 - a. Enter the ZIP code.

Note: The ZIP code is critical to point your dish accurately (refer to page 30).
 - b. Configure the dish (refer to page 30).
 - c. Point the dish (refer to page 30).
 - d. Test the System (refer to page 31).
4. After you have installed your DIRECTV System, you should contact DIRECTV to order DIRECTV® programming at 1-800 DIRECTV (1-800-347-3288).



Watching TV

The Info Banner shows information on the currently tuned program such as the rating, title, start and end time, program description, and channel number. It also displays the current time and date and indicates if any special features are currently enabled, such as Favorite Channels (page 19).

ALLDAY All Day Ticket (Pay Per View)	LB Letterbox format
ALT Alternate Audio Track	🔒 System Locked
CC Closed Captioning	🔓 System Temporarily Unlocked
✉ New Incoming Messages	💰 Pay Per View

Channel Number & Name

Start/End Time & Date

Channel Icon

Program Name & Description

On screen Display (OSD)

message space indicates error messages or status or song ID information (when you select a channel that contains audio only).

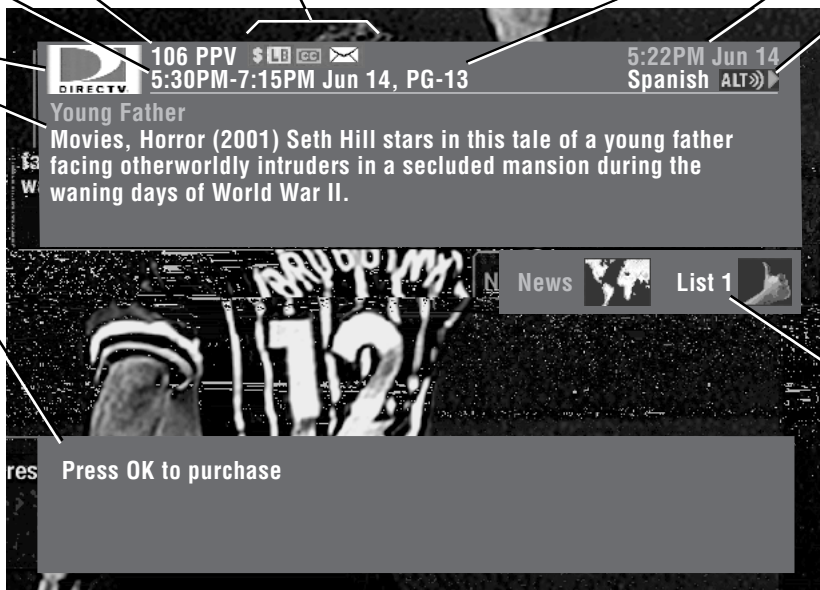

Rating

Current Time & Date

Current Alternate Audio Track

- The alternate audio icon indicates an alternate audio track is available. To change audio tracks, press the ◀ or ▶ button on the remote.

Favorites (page 19) status

Watching TV

To do this....

Do this....

Display the banner

Press INFO button on the remote

View program details

1. Press INFO to display the banner
2. Press INFO again to display program details

View other channels with the Browse Banner

You can see or “browse” what is on other channels without tuning away from the currently viewed program with the Browse Banner.

1. While watching a program, press the INFO button on the remote to display the banner.
2. While the banner is displayed, press the ▲▼ buttons to see what is showing on other channels.
3. Press SELECT to switch to the new channel displayed in the Banner or exit to remove the banner.

Note: When Favorite Channels (page 19) is in use, the Browse Banner will only show programs from those lists.

Enhanced User Features (cont'd)

Favorite Channels



Favorite Channels is an easy way to customize the listing of channels. Once Favorites is configured, the Favorites icon displays in the banner and programs displayed in the Program Guide are only those in the selected list. **When using the CH+ and CH- buttons, you are limited to channels in the Favorites list;** however, you can access any channel by entering its number directly on the remote control. You can save up to four different favorite channel lists. This way, members of a household can each set their own favorite channel list.

To access Favorite Channels:

1. Press MENU.
2. Use the ▼ button to select “Preferences” and press SELECT.
3. Use the ▼ button to select “Set Favorite Channels” and press SELECT.

Then, to select or edit a Favorite channel list:

1. Press the ▲▼ buttons to highlight the desired list, and press SELECT. To turn off any previously selected Favorites list, highlight “All Channels”, and press SELECT.
2. Then, use the ▲▼ buttons to highlight “Select” to activate your Favorite list and press SELECT. To edit the name or customize a Favorite channel list, select “Select and Edit” and press SELECT.

Select & Edit: Change List Name:

1. Select “Change List Name” and press SELECT.
2. Use the ◀▶▲▼ buttons to scroll through the alphabet. When the letter you want is selected, press SELECT. Repeat until you have spelled the list name.
3. When finished, select “Done” on the on-screen keyboard and press SELECT.

Select & Edit: Customize Favorites:

1. Select “Customize Favorites” and press SELECT.
2. You can manually select/deselect channels by highlighting a channel and pressing SELECT. Use the ▲▼ buttons to navigate through the list, or use the PAGE +/- buttons to scroll the list up or down by a complete page. “Select All” selects all channels in the list. You can then manually deselect any channel. “Deselect All” deselects all the channels in the list. You can then manually select any channel.
3. When customization is complete, Select “Save Changes” and press SELECT. Press BACK to return to the previous menu without saving your changes.

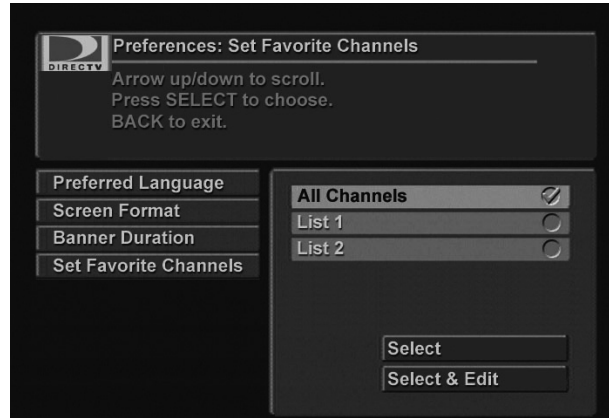

To access Favorites from the Main Menu, press MENU and select “Preferences”

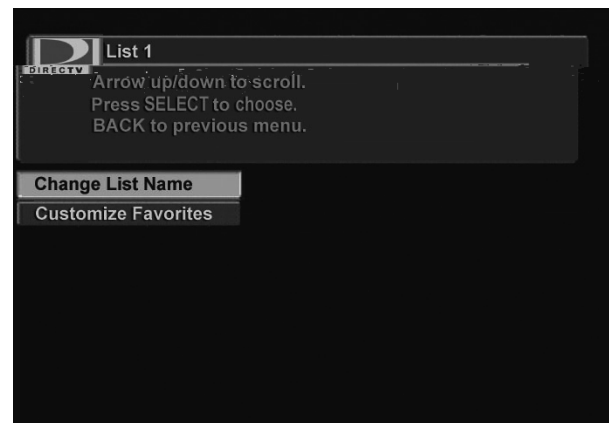

Select “Set Favorite Channels” in the “Preferences” menu

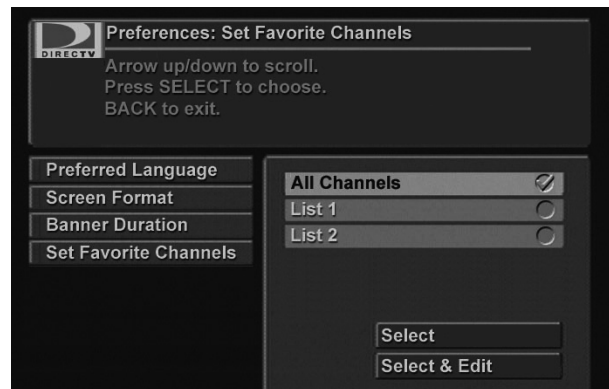

Change List Name



Customize Favorites

DIRECTV ADVANCED PROGRAM GUIDE®

DIRECTV ADVANCED PROGRAM GUIDE

The DIRECTV ADVANCED PROGRAM GUIDE offers complete TV listings for up to 3 1/2 days plus access to much more. The Guide lists programs according to their time slot and channel. With it, you can tune to a program, be notified when a program is about to start, order pay per view programs, search through listings by the type of program you're looking for, and set reminders for future viewing.

The **Channel Scroll Bar** shows the position of the channel relative to the total number of channels.

The **Channel List** shows the channels available.

Arrows indicate that the program extends beyond the time slot shown.

The **Clock** indicates that a Reminder for the program has been set for future viewing. If a Reminder is set, it will always display in the Guide cell. You will get notification before the program starts so that you can tune to it.

The **Program List** shows all the programs airing in a given time slot. If program names are too long to fit into a guide cell, they may be shortened. When a program is selected, its full name appears in the banner.

The **Banner** in the guide shows information on the highlighted program such as the rating, title, start and end time, program description, and channel number. It also displays the current time and date and indicates if any special features are currently enabled, such as Favorite Channels (page 19).

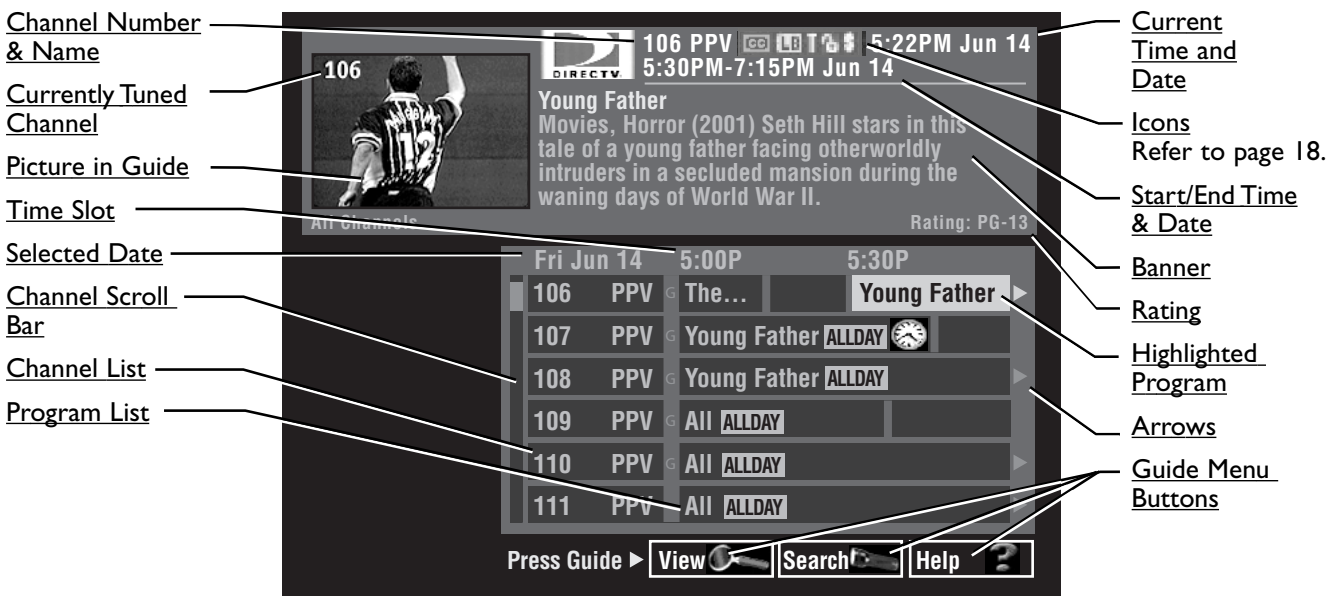

Using the Guide

To do this....	Do this....
Display the Guide	Press the GUIDE button on the remote control or select "Guide" from the Main Menu.
Scroll through the Program List	Press the ▲▼ buttons. You can use the PAGE+/- buttons to scroll a full page at a time.
Scroll to another time slot	Press the ◀▶ buttons. Program information displays in the banner.
Choose a program to view	Press the arrow buttons until the program you want to view is highlighted in the Guide. If the program is in the current time slot, pressing SELECT tunes to the selected channel and displays the information for the program in the banner. If the program is in a future time slot, you are given the option to set a Reminder (refer to page 21). If the selected future program is pay per view, you are also given the option to purchase the program.
View program details	You can toggle between the guide and program details by pressing the INFO button on the remote.

DIRECTV ADVANCED PROGRAM GUIDE[®] (cont'd)

Using the Guide (cont'd)

To do this....	Do this....
Set a Reminder for future viewing 	You can set up your viewing schedule ahead of time, so that you will be automatically notified of the shows you want to see. In the Guide, Reminders display as a clock to the right of the program title. If you wish to record a program using your VCR, set the VCR's timer recording also. Refer to your VCR's owner's manual for timer recording instructions. The DIRECTV [®] Receiver will turn on at the correct time and tune to the channel if a Reminder is set.
To set a Reminder for a non-pay per view program	<ol style="list-style-type: none">1. Highlight a future program in the guide and press SELECT. In the Reminder screen, choose whether you want to select this program once, daily, weekly, or Monday-Friday. Remember, you are actually setting the Reminder by the time slot, so if the program moves to a different time slot, you will need to reset the Reminder.2. Press SELECT. <p>If the program is in the same time slot as another Reminder, the system will prompt you that a conflict exists.</p>
To set a Reminder for a pay per view program	<ol style="list-style-type: none">1. When a future pay per view is purchased, you are given the option to set a Reminder in the purchase details screen. If you set the Reminder for a purchased pay per view, you will be charged when the event airs.
To cancel a Reminder for a program	<ol style="list-style-type: none">1. Highlight the program in the guide and press SELECT.2. Choose "Once" if you want to cancel a Reminder program for one time slot only, or "Always" if a program has been set as a Reminder more than once, for example, a program that airs every day. Then, press SELECT.

PPV (Pay Per View)

Pay per view programs include special programming, movies, and sporting programs and are indicated by a "\$" in the banner. In the Guide, you can preview currently airing PPV programs, purchase current and future PPV programs, and cancel a purchase. From the Main Menu, you can view the purchase history, cancel purchases, and restrict this feature by setting rating and spending limits.

To purchase a PPV program:

1. Highlight the program in the Guide and press SELECT.
2. Select "Buy" and press SELECT. The price will display on the button. If you have locked your DIRECTV Receiver and the rating or spending limit is exceeded, you must enter your access code to temporarily unlock the receiver (refer to page 27) before you can purchase it.
3. Select "Showings" to see a list of alternate show times. Press the ▲▼ buttons to move to the next selectable showing (if available), then press the SELECT button to select it.
4. Press SELECT to confirm your purchase.

Note: To order PPV, the DIRECTV Receiver must be continuously connected to a land-based phone line.

Guide Menu

Guide Menu

The bottom of the Guide screen (refer to page 20) contains three buttons that can be accessed by pressing the GUIDE button on the remote control when the Guide is already displayed.

- Use the ◀▶ buttons to highlight a button and press SELECT to view its list of options.
- To close the list of options and select another Guide Menu button, press BACK.
- To return to the Guide press BACK again or GUIDE.
- To exit to watch TV, press Exit.

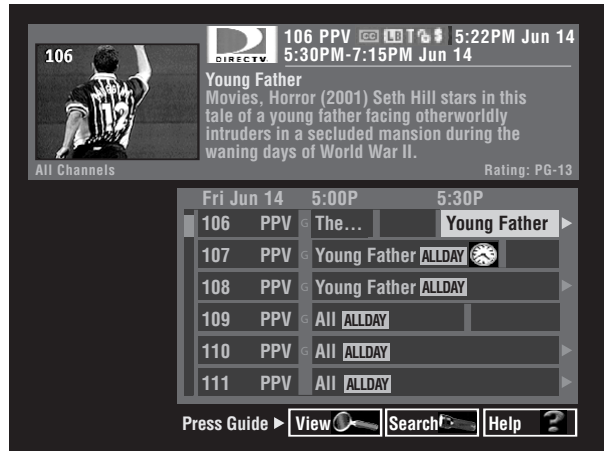

Guide Menu:View

Selecting “View” displays “Go To Time, Pay Per View, Reminder List and Time Reminder.” Use the ▲▼ buttons to select from the View options. Press SELECT or ▶ to select an option.

- Jump to specific time slot in guide
- EZ Search Pay Per View (see page 21)
- List of Reminders set (see page 22)
- Set a Reminder by specific date, time and duration

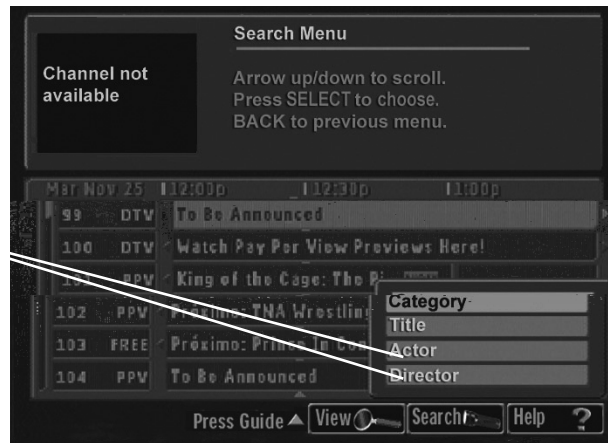
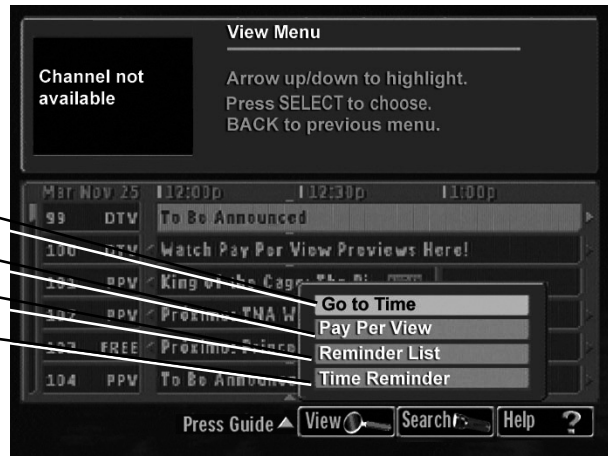

Guide Menu (cont'd)

Guide Menu: Search: Category

A category search allows you to choose from a predefined list of categories and subcategories. The ► arrow indicates the category has subcategories.

1. Use the ▲▼ buttons to highlight a category or the ► arrow to view a list of subcategories.
2. Press SELECT to select one category or subcategory to search.



Choose a category to search

Guide Menu: Search: Title/Actor/Director

To search for a specific title, actor or director:

1. Use the ◀▶▲▼ buttons to scroll through the alphabet. Highlight the letter you want, and press SELECT. Repeat until you have spelled part or all of the title, actor or director's name.
2. When finished, highlight "Done" on the on-screen keyboard and press SELECT.

Note: Ignore punctuation and accents. For example, enter JOHN'S as JOHNS and DAY-TO-DAY as DAYTODAY. When entering a full name, enter FIRST <space> LAST.



Enter the name of the title, actor or director with the on-screen keyboard

Guide Menu: Search Results

Once your search is completed you will see a list of results on the screen. Use the ▲▼ buttons to highlight a program and press INFO to view the program details or SELECT to view a list of program showing times.

In addition to the icons on page 18, the list of program showing times includes additional icons to reflect the available alternate audio tracks.

[ENG] English	[ITA] Italian
[ESP] Spanish	[JPN] Japanese
[FRA] French	[KOR] Korean
[DEU] German	[CHN] Chinese

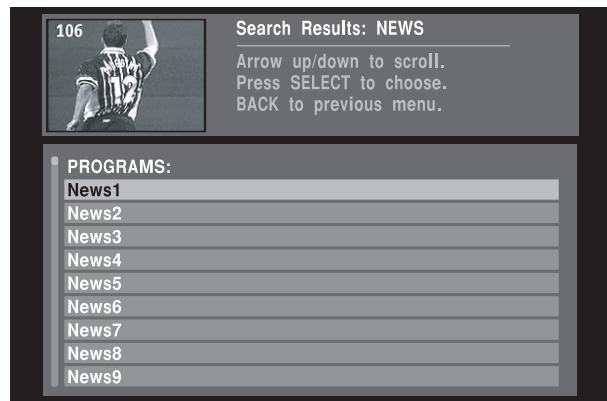

"Search Results" screen

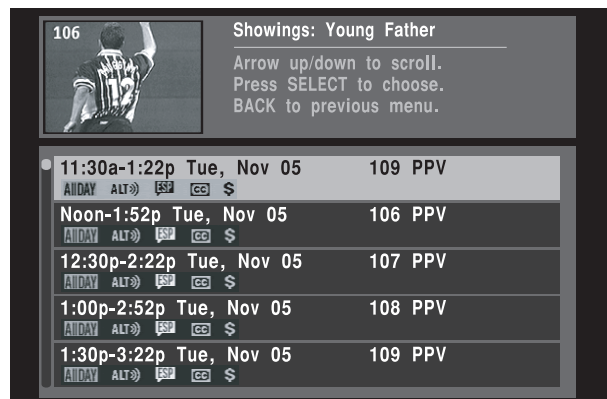

"Showings" screen

Main Menu

Using the Main Menu

The Main Menu lets you customize the features of your DIRECTV® Receiver.

To access the Main Menu from the Guide or TV:

Press the MENU button on the remote control.

To exit the menu:

Press the MENU button or EXIT.

To navigate through the menus:

Use the ▲▼ buttons to highlight an option. Then press SELECT or ► to confirm the selection and display a sub-menu. Selecting items in a sub-menu displays options in which you can change or review settings.

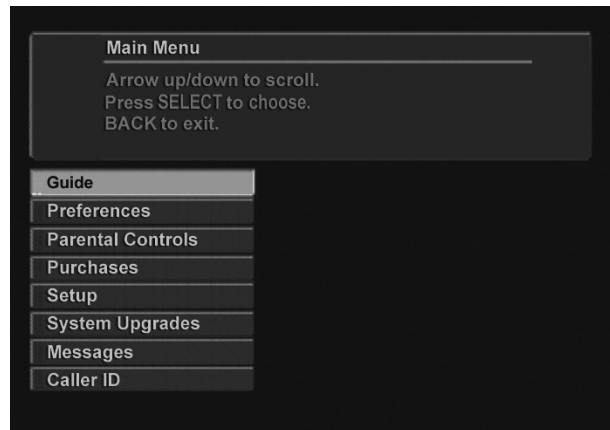

Press MENU button to view Main Menu

Main Menu (cont'd)

Main Menu: Preferences

The Preferences option in the Main Menu lets you change the “Preferred Language”, screen format, or banner duration, set or edit the favorite channels list, and set the remote control ID. To change your preferences, select “Preferences” in the Main Menu and press SELECT. In the sub-menus that display, use the ▲▼ buttons to highlight your selection. Press BACK to return to the Main Menu.

Preferences: Preferred Language

Many programs are broadcast with program information and audio tracks in different languages. You can choose the preferred language for the text in the Menu and Guide and for the audio tracks of programs.

Note: Not all programs offer multiple languages. If the selected program is not available in the language you prefer, it defaults to English.

To choose a language:

1. Press MENU. The Guide option will be highlighted. Press ▼ to select “Preferences” and press SELECT.
2. Select “Preferred Language” and press SELECT.
3. Use the ▲▼ buttons to choose either “Menu & Guide” or “Audio Track” and press SELECT. The currently selected language has a checkmark to its right.
4. Use the ▲▼ buttons to choose a language from the list. Press SELECT.

If desired, repeat steps 3-4 to change the other option.

Note: Once the language of the “Menu & Guide” menu is changed, the Receiver will reset and the new language will be used.

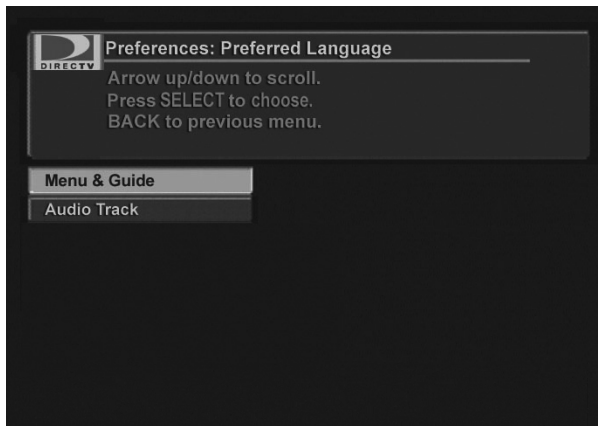

Select preferred language of text in the Menus and Guide in the “Menu & Guide” menu



Select preferred language of every program in the “Audio Track” menu

Preferences: Screen Format

To select a screen format:

1. Press MENU.
2. Press ▼ to select “Preferences” and press SELECT.
3. Press ▼ to select the “Screen Format” and press SELECT.
4. Use the ▲▼ buttons to choose from the options.
5. Once you have made your selection, press SELECT.

Note: Most standard TVs are 4:3 and that is the recommended setting. If you have a widescreen TV, select 16:9.

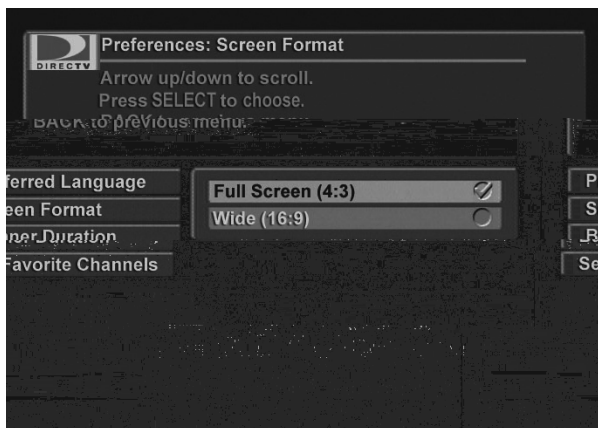

“Screen Format” menu

Main Menu (cont'd)

Preferences: Banner Duration

Banner durations define how long the banner remains on the screen after you press INFO. Options are 5 or 10 seconds.

The default value is 10 seconds.

To select the banner duration:

1. Press MENU.
2. Press ▼ to select "Preferences" and press SELECT.
3. Press ▼ to select "Banner Duration" and press SELECT.
4. Use the ▲▼ buttons to choose from the options.
5. Once you have made your selection, press SELECT.

Preferences: Set Favorite Channels

Refer to Enhanced User Features section, page 19.

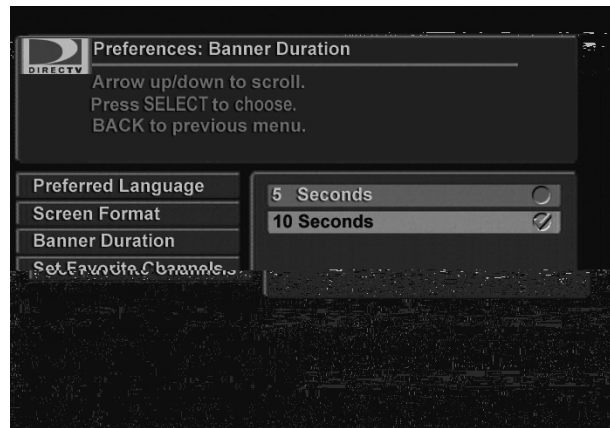

"Banner Duration" menu options

Main Menu (cont'd)

Main Menu: Parental Controls

If you want to control what channels and programs are being watched or how much is being spent on each pay per view purchase, Parental Controls allows you to do this with channel locks, spending limits, and rating limits. Parental Controls are protected by a 4-digit numeric password that you set.

To access this feature:

1. Press MENU.
2. Press ▼ to select "Parental Controls" and press SELECT.
3. Use the ▲▼ buttons to choose from the options and press SELECT.

Parental Controls: Lock The System (Lock/Unlock The DIRECTV® Receiver)

Once any Parental Control setting has been configured, the DIRECTV Receiver must be locked in order for those changes to take effect. Your DIRECTV Receiver can be locked or unlocked. When it is locked, the system will prompt you to enter the password whenever you want to change settings in the following menus: "Channel Locks", "Set Rating Limits", or "Set Spending Limits". The lock icon in the banner indicates a locked system.

To lock or unlock the system:

1. Choose "Lock The System" or "Unlock The System" from the "Parental Controls" menu.
2. When the system prompts you for a password, enter it using the numeric buttons on the remote control. If locking the system, you will need to confirm it before it takes effect. If you have forgotten or lost your password, contact your service provider.

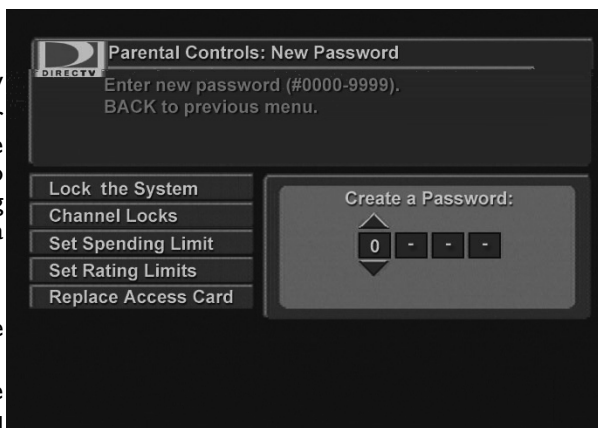

"Parental Controls" menu

Parental Controls: Channel Locks

Locking channels prevents a viewer from accessing the channels by requiring a password. You must lock the DIRECTV Receiver to enforce these settings (see above).



To set Channel Locks:

1. Choose "Channel Locks" from the "Parental Controls" menu and press SELECT.
2. To lock /unlock all channels, use the ▲▼ buttons to select "Lock All", or "Unlock All" and press SELECT.
3. To manually lock/unlock individual channels, press ►. Then, use the ▲▼ buttons to select a channel and press SELECT to toggle between lock and unlock.
4. Use the PAGE +/- buttons to scroll the channel list by a full page.
5. To store your new settings, select "Save Changes" and press SELECT.

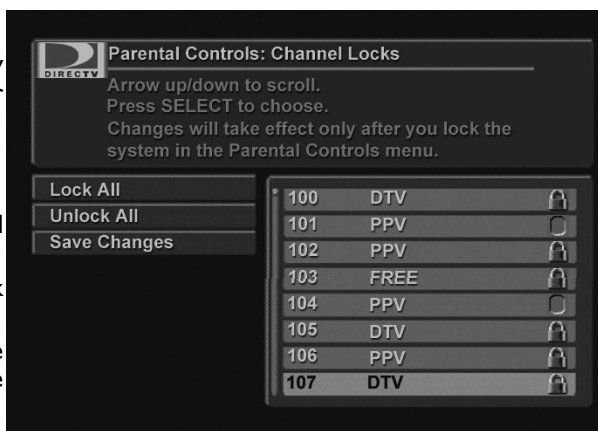





"Channel Locks" menu

Main Menu (cont'd)

Parental Controls: Set Spending Limit

You can set a per purchase spending limit on pay per view programs. It is not a cumulative limit. You must lock the DIRECTV® Receiver to enforce this setting (refer to page 27).

To set the Spending Limit:

1. Choose "Set Spending Limit" from the "Parental Controls" menu and press SELECT. The current purchase limit displays.
2. Enter the spending limit using the numeric buttons on the remote. Or, use the   buttons to move from one digit to another; then use the   buttons to set the value for each digit.

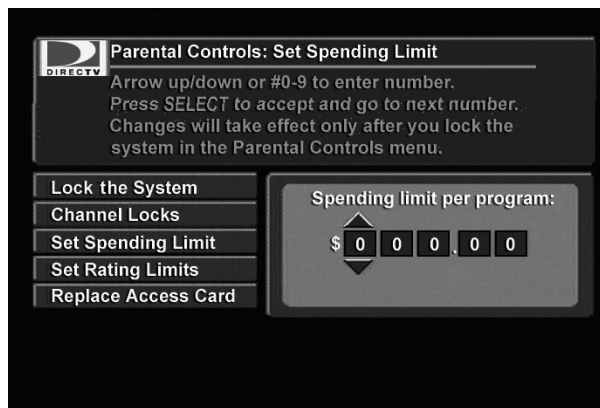



"Set Spending Limit" menu

Parental Controls: Set Rating Limit

You can restrict viewing by setting the rating limits to certain levels. Ratings help you determine programming content, similar to the way films are rated. For example, a rating of "G" is a program suitable for general audiences, while a rating of "R" might be suitable for adults only. You must lock the system to enforce these settings. To view a locked program, you must first enter a password.

To set the Rating Limits:

1. Choose "Set Rating Limits" from "Parental Controls" menu and press SELECT.
2. There are three rating systems to set: Children-TV, Entire Audience-TV, and MPAA-Movies. You can lock or unlock all ratings in each system. When you lock a particular rating, all ratings exceeding the locked rating are automatically locked as well. For example, if you lock "R", "NC-17" and "X" will be automatically locked. Press   to select the desired limit and press SELECT to lock or unlock it. The Children-TV and Entire Audience-TV options contain sublevel ratings that can further identify the programming content.





"Children-TV" rating system

Parental Controls: Replace Access Card

Use this menu to replace your current card with a new one, sent by your service provider. Be sure to follow the on-screen instructions. For information on inserting access cards, see page 8.

To replace your access card:

1. Press MENU.
2. Use the   buttons on the remote control to highlight "Parental Controls". Press SELECT.
3. Choose "Replace Access Card", then press SELECT. Be sure the current access card is inserted in the DIRECTV Receiver. "Copying OLD access card information" will appear on the screen.
4. When prompted, remove the old card, insert the new card, then press SELECT.
5. When this process is completed, press SELECT to return to the previous menu.
6. Discard the old card since it no longer works.

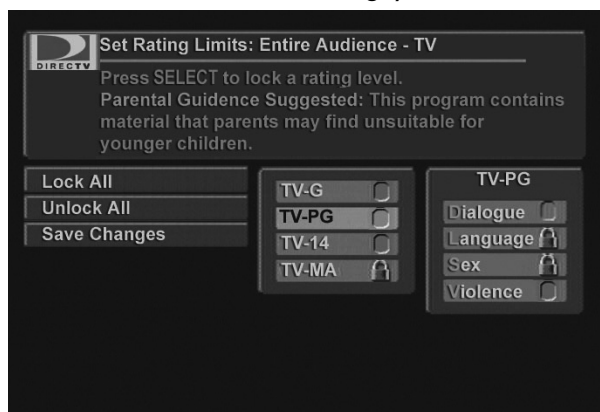

"Entire Audience" rating system

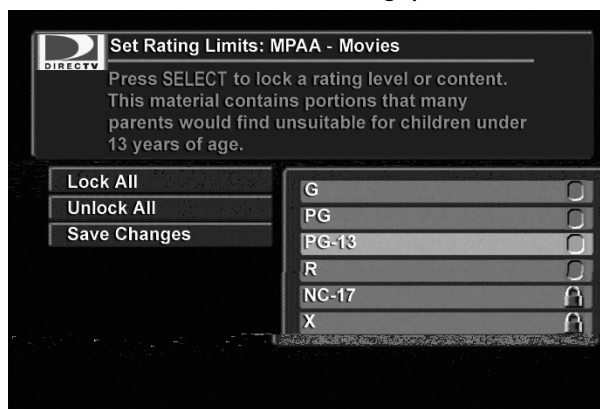

"MPAA-Movies" rating system

Main Menu (cont'd)

Main Menu: Purchases

Purchases: Past Purchases

The Past Purchases menu displays a summary of your past pay per view purchases. It includes the program name and channel number, program date, start and end time, price, and whether the program was viewed or cancelled. Information for all past purchases is stored on the access card and displayed with the most recent purchase first.

To view past purchases:

1. Press MENU.
2. Choose "Purchases" from the main menu and press SELECT.
3. Use the ▲▼ buttons to choose "Past Purchases" and press SELECT.
4. A list of past purchases displays indicating whether they were viewed or cancelled. You can scroll through the list using the ▲▼ buttons or using the PAGE+/- buttons to scroll by a full page.

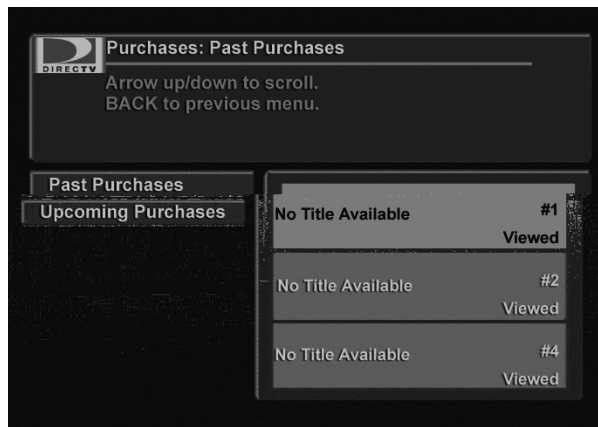

"Past Purchases" menu

Purchases: Upcoming Purchases

The Upcoming Purchases menu displays all future pay per view programs that you have purchased but not cancelled. You may cancel any pay per view program you have not yet watched that was purchased through the DIRECTV Receiver.

Note: You cannot cancel a PPV purchase if you have already tuned to the program.

To cancel purchases:

1. Press MENU.
2. Choose "Purchases" from the main menu and press SELECT.
3. Choose "Upcoming Purchases" and press SELECT.
4. A list displays of upcoming purchases that were ordered but not viewed. You can scroll through the list using the ▲▼ buttons or using the PAGE+/- buttons to scroll by a full page.
5. To delete a pending purchase, highlight it and press SELECT. A checkmark will appear.
6. Select "Save Changes" and press SELECT to cancel all checked programs from the upcoming purchases list.
7. You can verify the purchase was cancelled by checking in the "Past Purchases" menu.

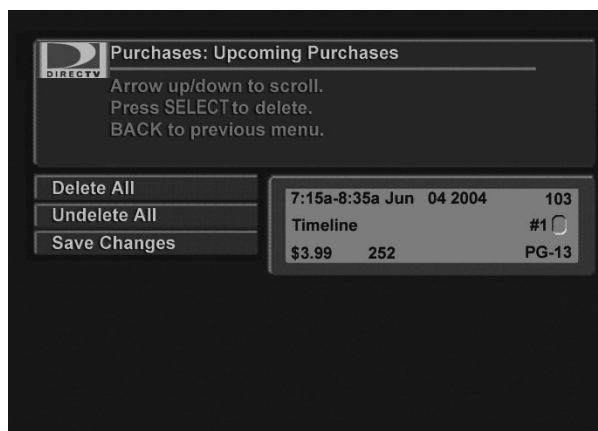

"Upcoming Purchases" menu

Main Menu (cont'd)

Main Menu: Setup

Use this menu to run through the setup process (professional installation is highly recommended). Configure each setting within "Enter ZIP Code" and "Dish Configuration." Use "Point Dish" and "System Test" to confirm your setup.

To view Setup options:

1. Press MENU.
2. Select "Setup" and press SELECT.
3. Use the ▲▼ buttons to select one of the "Setup" menu options.

Setup: Enter ZIP Code

Use this function to correctly position the satellite antenna.

To enter your ZIP code:

1. At the "Setup" menu, select "Enter ZIP Code" and press SELECT.
2. Enter the ZIP code using the numeric buttons on the remote, or use the ▲▼ buttons to select each digit in the ZIP code field. Press the ► button to move to the next field.

Helpful Hint

- Your ZIP code is critical to the installation process.

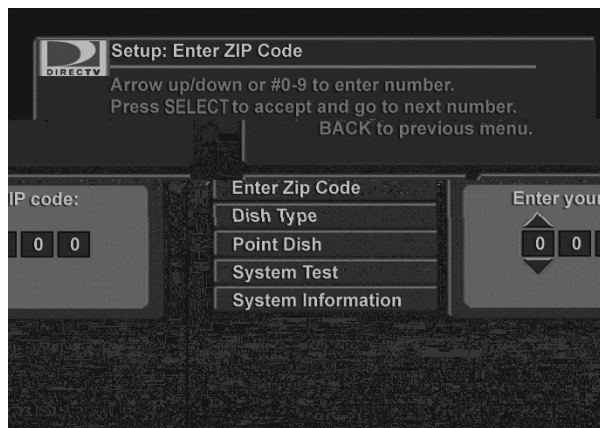

"Enter ZIP Code" menu

Setup: Dish Type

Use this function to identify your type of satellite antenna dish.

To select your dish type:

1. At the "Setup" menu, select "Dish Type" and press SELECT.
2. Use the ▲▼ buttons to select "Manual Selection" if you know the type of dish you have. Otherwise, contact your installer or select "Auto Selection" and press SELECT.
3. Use the ▲▼ buttons to manually select your dish type and press SELECT.

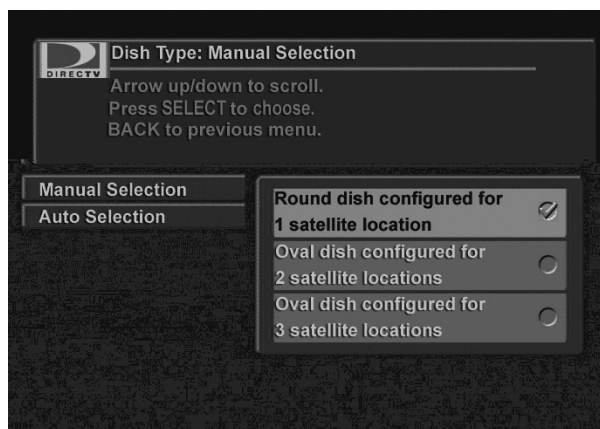

"Manual Selection" menu options

Setup: Point Dish

Use this function to manually point the dish and correctly align it with the satellite(s). You may want to have a helper to read the onscreen displays for you during this procedure. Signal strength readings change approximately 2 seconds after each adjustment is made.

Note: Single dish installations often show higher signal strength than installations that receive signals from two or three satellites. The onscreen display will tell you how to align your dish based on your ZIP code.

To point your dish:

1. At the Setup menu, select "Point Dish" and press SELECT.
2. A signal strength meter displays. Adjust the dish until the signal strength meter stabilizes at a maximum reading. The range is 0 to 100. It is recommended to obtain a signal strength of at least 60. An audible tone will help with this procedure. The tones or beeps get faster as the signal strength increases until it becomes a continuous sound. If you have problems getting a signal, refer to the troubleshooting section of the user manual (page 33).

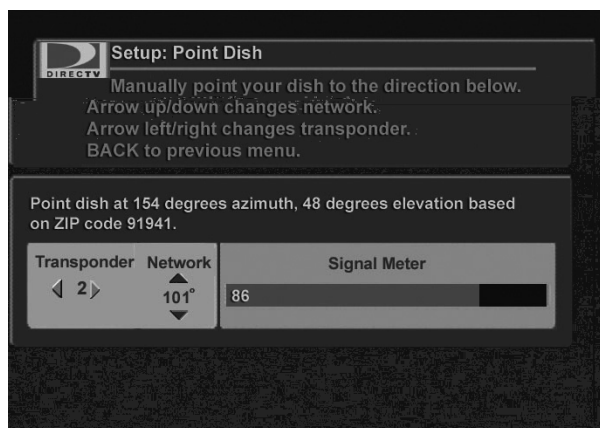

Note: Use the ▲ or ▼ buttons to switch between satellites. Use the ◀ or ▶ buttons to switch between transponders for the selected satellite.

Main Menu (cont'd)

Setup: System Test

This option performs a test of the system. This information is useful in troubleshooting if you need to contact customer service.

To run a system test:

1. At the Setup menu, select "System Test" and press SELECT. A message "Test in progress, Please Wait . . ." may appear. After a few seconds, the test results will display.

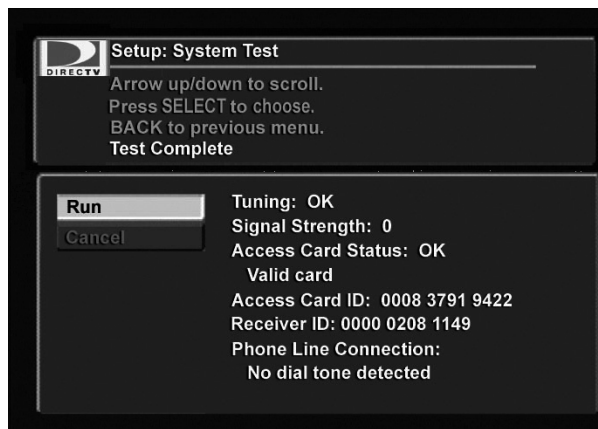

"System Test" menu

Setup: System Information

This option shows information about your hardware and software that will be useful in troubleshooting if you need to contact customer service.

To view system information:

1. At the Setup menu, select "System Information" and press SELECT.
2. Use the PAGE +/- buttons to scroll the information.

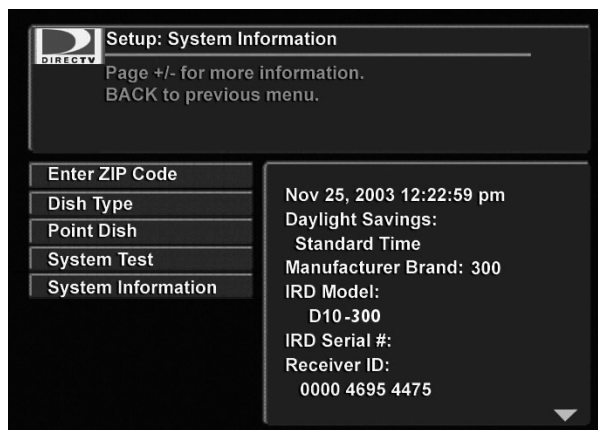

"System Information" menu

Main Menu: System Upgrades

Your DIRECTV® Receiver is able to receive upgrades or modifications to some of its features and functions. These modifications will occur automatically, usually at times when the DIRECTV Receiver is not likely to be in use. If your DIRECTV Receiver is on when an upgrade or modification is sent, reception may be interrupted for a minute or two. Reception should return to normal after the modification is complete. Your DIRECTV Receiver must be plugged in to receive an upgrade. Do not unplug your DIRECTV Receiver while an upgrade is in progress. Consult the System Upgrades Menu to find a schedule of upgrades or modifications planned by DIRECTV.

To view past or future upgrades:

1. Press MENU.
2. Select "System Upgrades" in the Main Menu and press SELECT.
3. Use the ▲▼ buttons to select "Past Upgrades" or "Future Upgrades" and press SELECT.

Main Menu (cont'd)

Main Menu: Messages



When you receive a new message, the New Incoming Messages icon appears in the banner. You can view and delete messages. Each message includes the date and time it was sent. When new messages are received, the oldest message is automatically deleted if the maximum amount of messages (30) is exceeded. The banner on the Message screen indicates how many messages you have.

To view messages:

1. Press MENU.
2. Use the ▲▼ buttons to choose “Messages” and press SELECT.
3. Use the ▲▼ buttons to select and view a message.
4. When a message is displayed, press SELECT to delete a message (the torn envelope icon indicates a deleted message).
5. When you press BACK or EXIT, all deleted messages are removed permanently and will not display the next time you view messages.

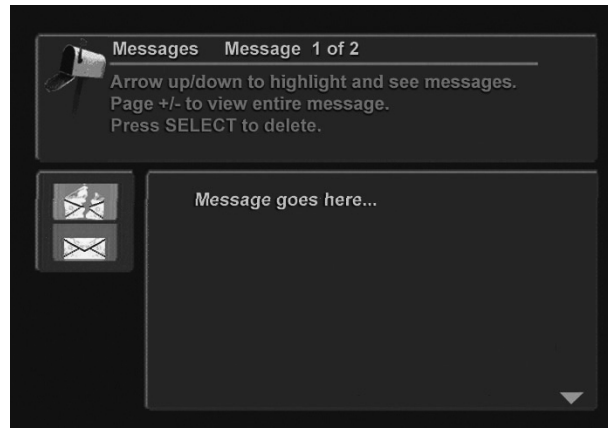

“Messages” menu

Main Menu: Caller ID

Note: You must have phone line connected to your Receiver and be subscribed to Caller ID service from your phone service provider. When a phone call comes in, a display will appear containing call information.

To enable or disable Caller ID:

1. Press the MENU button. Use the ▲▼ buttons to select “Caller ID” and press SELECT.
2. Use the ▲▼ buttons to select “Enable/Disable” and press SELECT.
3. Use the ▲▼ buttons to select either “Enable” or “Disable” and press SELECT.

To view Caller ID history:

At the Caller ID screen, use the ▲▼ buttons to select “Call History” and press SELECT. The history information will be displayed.

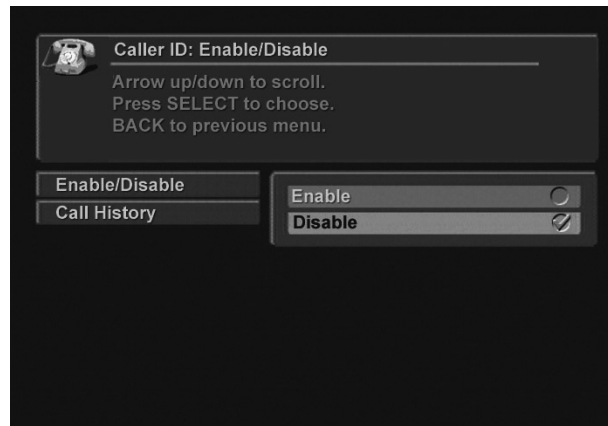

“Caller ID” options

Troubleshooting

Where To Find Help

General help is available by highlighting the "HELP" button in the Guide menu and pressing SELECT.

No picture / poor picture	<ol style="list-style-type: none"> 1. Press the POWER button on the front panel of the DIRECTV® Receiver if the power indicator LED is not on. 2. Make sure TV power is on. 3. Check TV connection from the DIRECTV Receiver. <ol style="list-style-type: none"> a. If using RF output, tune TV to channel 3 or 4 to match the channel switch on the rear panel of the DIRECTV Receiver. b. If using composite, S-Video, or component outputs, select the proper input on your TV. 4. Make sure the SAT IN coaxial cable is properly connected to the antenna's LNB or multiswitch. Check the cable for kinks. 5. Check the satellite antenna's signal strength (see page 30). To ensure a quality picture, make sure the output signal is coming directly from the DIRECTV Receiver and not through your VCR. 6. Turn DIRECTV Receiver off, unplug, wait 10 to 15 seconds, and plug back in. <p>Note: Adverse weather conditions may affect picture quality.</p>
No sound	<ol style="list-style-type: none"> 1. Make sure that the TV volume is not set to mute. 2. Check audio connections from the DIRECTV Receiver to the TV. Select the proper inputs on your TV. 3. Check if the problem exists on other channels. If so, turn DIRECTV Receiver off, unplug, wait 10 to 15 seconds, and plug back in.
Remote does not work	<ol style="list-style-type: none"> 1. Make sure the batteries are inserted correctly (see page 13) and are not dead. 2. Be sure you are within operating range of the DIRECTV Receiver. 3. Make sure no objects obstruct the line of sight between the remote and the DIRECTV Receiver.
Ordering or cancelling pay per view	<ol style="list-style-type: none"> 1. Cannot order - <ol style="list-style-type: none"> a. It may be too late to purchase the program. Check for other show times. b. Check phone cord connection on rear panel of the DIRECTV Receiver and at the wall jack. Keep phone cord connected. 2. Cannot cancel - you cannot cancel pay per view orders that you've watched or tuned to, or ones not ordered through your DIRECTV Receiver.
Parental Controls	<ul style="list-style-type: none"> • The system must be locked before your Parental Controls settings will take effect (see page 27). • The system must be unlocked before you can make changes to the Parental Controls settings.
Favorites	Cannot disable - press the POWER button to go into standby and press the POWER again to bring DIRECTV Receiver out of standby.
Cannot access channel(s)	<ol style="list-style-type: none"> 1. Check that you are subscribing to the station to which you want to tune to. 2. Be sure the system is not locked as indicated by a lock icon in the banner. 3. Make sure Favorites is not turned on. See "Favorites" above for instructions to cancel either feature.
Caller ID not working	<ol style="list-style-type: none"> 1. Phone line must be directly connected to the phone wall jack. 2. Make sure there are no other devices in the phone connection, such as caller ID boxes.

Technical specifications

Video Decoding

- MPEG-2 DSS compliant (up to Main Profile/Main Level)
- Video bit rate: up to 15 Mbit/sec
- Video format: 4:3 and 16:9
- Resolution: up to 720 x 480 pixels

Audio Decoding

- MPEG-I layer II
- Sampling frequency: 48 kHz - 32 kHz - 44.1 kHz
- MPEG-I system packets
- Audio mode: Single channel, dual channel, stereo, joint stereo.

Satellite Antenna Interface

- RF input: F-type connector, 75 ohm
- LNB supply: 0V / 14V / 18V
- LNB current: max. 300mA on 14V max. 450mA on 18V
- Tone switching (on/off): 22 kHz
- DiSeqC 2.0 compatible.

Reception Demodulation

- QPSK Type
- Input frequency range: 960 to 2030 MHz
- Input level range: -69 to -15 dBm
- Symbol rate: 30 Msymbol/sec
- Satellite band coverage: KU band.

Input/Output Interfaces

- 1 Multi - Satellite input
- TV input
- Video output: CVBS 2 video outputs
- Audio output: Audio L/R 2 audio outputs
- S-video output (Y/C)
- Channel 3/4 (TV/VCR) output with selection switch
- RJ-11 for modem

Integrated telephone modem (Return Path)

- Built-in RJ-11 connector
- Modem type: v.22bis, 2400 baud
- Dialing mode: DTMF & pulse
- Error correction V42
- Caller ID

Electrical

- Mains power supply: 120V (10%, 60Hz)

Environmental

- Temperature
 - Operating temperature is: 32°F to 104°F
 - Storage temperature is: -40°F to 150°F

Physical Dimensions

- Size: 11.33" (W) x 1.81" (H) x 7.71" (D)
- Weight D10 -300: 1.15 kg = 2.54 lbs
- Weight D10 -300 packaged with accessories : 2.25 kg = 4.96 lbs

Package Contents

- Digital Satellite Receiver
- 1 x Universal IR remote control
- Battery type: Two AA
- DIRECTV Access card
- Mains power supply cord
- A/V RCA cable
- S-Video cable
- Phone cord
- User Guide

Subject to change without prior notification

Limited Warranty

LIMITED 90 DAY WARRANTY DIRECTV

warrants your DIRECTV Receiver (Model Number: D10-300) and any included accessories against defects in material or workmanship for a period of ninety (90) days after the date of purchase.

WHO IS COVERED ?

You must have proof of purchase to receive warranty service. A sales receipt or other document showing that you purchased the product is considered proof of purchase. THIS LIMITED WARRANTY EXTENDS ONLY TO THE ORIGINAL CONSUMER PURCHASER OR ANY PERSON RECEIVING THE DIRECTV RECEIVER AS A GIFT FROM THE ORIGINAL CONSUMER PURCHASER AND TO NO OTHER PURCHASER OR TRANSFEREE. THIS WARRANTY DOES NOT EXTEND TO COMMERCIAL USERS. THIS PRODUCT IS NOT AUTHORIZED FOR USE OUTSIDE THE UNITED STATES AND ANY SUCH USE VOIDS THIS WARRANTY.

WHAT IS COVERED ?

Warranty coverage begins the day you purchase the product. For ninety (90) days from the purchase date, at the option of DIRECTV, the DIRECTV Receiver will be repaired or replaced with a new, repaired, refurbished or comparable product (whichever is deemed necessary) if it becomes defective or inoperative. This exchange is done without charge to you for parts and labor. You will be responsible for the cost of shipping to and from the location designated by DIRECTV. If DIRECTV cannot reasonably repair or replace the Receiver then DIRECTV may, at its sole discretion, refund the price you paid for the product or the current retail price of the product. All products, including replacement products, are covered only for the original warranty period. When the warranty on the original product expires, the warranty on the replacement product also expires. After ninety (90) days from the date of purchase, you pay for the replacement of all parts, and for all labor charges. SOME STATES DO NOT ALLOW LIMITATIONS ON HOW LONG AN IMPLIED WARRANTY LASTS, SO THE ABOVE LIMITATION MAY NOT APPLY TO YOU.

WHAT IS EXCLUDED ?

Your warranty does NOT cover:

- Labor charges for installation or setup of the product.
- Installation, performance of, or repair of: audio/video cabling, telephone line, or accessory attachments used with the product.
- Product replacement because of misuse, accident, lightning damage, unauthorized repair, or other cause not within the control of DIRECTV.
- Incidental or consequential damages resulting from the product. SOME STATES DO NOT ALLOW THE EXCLUSION OF INCIDENTAL OR CONSEQUENTIAL DAMAGES, SO THE ABOVE EXCLUSION MAY NOT APPLY TO YOU.
- Any modifications or other changes to the product, including but not limited to software or hardware modification in any way other than as expressly authorized by DIRECTV will void this limited warranty. Except in the case of hardware or software provided by DIRECTV, installing software modifications, "hacks" or utilizing service access or "back doors" will void this limited warranty.
- Reception transmission problems caused by signal conditions, telephone line, or cable or antenna systems outside the unit.
- A product that has been modified or adapted to enable it to operate in

any country other than the country for which it was designed, manufactured, approved and/or authorized, or repair of products damaged by these modifications.

- A product used for commercial or institutional purposes.
- DIRECTV makes no warranty that the access connection will be a local (not long distance) phone call.
- The continued provisioning of any of the programming and other services delivered through the Receiver including but not limited to television programming, show information, program guide data, and scheduling information.

MAKE SURE YOU KEEP...

Please keep your sales receipt or other document showing proof of purchase. Attach it to this User Guide and keep both nearby. Also keep the original box and packing material in case you need to return your product.

BEFORE REQUESTING REPAIR SERVICE...

Please check the troubleshooting section of this guide. This may save you a call to DIRECTV Customer Care.

TO GET WARRANTY SERVICE...

Warranty service will be provided by DIRECTV. If you believe you need service for your Receiver, contact DIRECTV at 1-800-DIRECTV (1-800-347-3288). A representative will go through a diagnostic checklist with you. If it is determined that the product needs to be returned for service or exchanged, you will receive a return authorization number. The representative will give you complete shipping details.

TO GET OUT-OF-WARRANTY SERVICE...

To obtain out-of-warranty service contact DIRECTV at 1-800-DIRECTV (1-800-347-3288) for information on the possibility of and any costs for repair or replacement of out-of-warranty products.

REMEMBER...

Record the model and serial numbers found on the product below.

MODEL # _____

SERIAL # _____

ALL WARRANTIES IMPLIED BY LAW, INCLUDING ANY IMPLIED WARRANTIES OF MERCHANTABILITY AND FITNESS FOR A PARTICULAR PURPOSE ARE EXPRESSLY LIMITED TO THE DURATION OF THIS EXPRESS LIMITED WARRANTY. WITH THE EXCEPTION OF ANY WARRANTIES IMPLIED BY THE LAW OF ANY STATE OF THE U.S.A., THIS EXPRESS LIMITED WARRANTY IS EXCLUSIVE AND IN LIEU OF ALL OTHER WARRANTIES, GUARANTEES, AGREEMENTS AND SIMILAR OBLIGATIONS OF DIRECTV. REPAIR OR REPLACEMENT AS PROVIDED IN THIS LIMITED WARRANTY IS THE EXCLUSIVE REMEDY UNDER THIS LIMITED WARRANTY. IN NO EVENT WILL DIRECTV BE LIABLE FOR ANY AMOUNT GREATER THAN THE RETAIL PRICE OF THE DIRECTV RECEIVER. DIRECTV SHALL NOT BE LIABLE FOR ANY INCIDENTAL OR CONSEQUENTIAL DAMAGES FOR BREACH OF ANY EXPRESS OR IMPLIED WARRANTY ON THE DIRECTV RECEIVER. SOME STATES DO NOT ALLOW LIMITATIONS ON WARRANTIES, SO THE ABOVE LIMITATIONS MAY NOT APPLY TO YOU. THIS WARRANTY GIVES YOU SPECIFIC LEGAL RIGHTS. YOU MAY HAVE OTHER RIGHTS WHICH VARY FROM STATE TO STATE. DIRECTV, Inc. 2230 E. Imperial Hwy El Segundo, CA 90245 1-800-DIRECTV

This warranty gives you specific legal rights. You may have other rights which vary from state/province to state/province.

DIRECTV PROTECTION PLAN

DIRECTV PROTECTION PLAN

Protect your DIRECTV[®] System with the DIRECTV PROTECTION PLAN. For a low monthly fee, the DIRECTV PROTECTION PLAN covers the components of your DIRECTV System, giving you peace of mind and comprehensive support to ensure that you and your family enjoy nonstop DIRECTV[®] entertainment.

DIRECTV PROTECTION PLAN BENEFITS

Your DIRECTV Limited Warranty provides certain remedies for this receiver during the stated coverage term. The DIRECTV PROTECTION PLAN provides comprehensive coverage for your DIRECTV System, including:

- In home service calls when needed

Free Manuals Download Website

<http://myh66.com>

<http://usermanuals.us>

<http://www.somanuals.com>

<http://www.4manuals.cc>

<http://www.manual-lib.com>

<http://www.404manual.com>

<http://www.luxmanual.com>

<http://aubethermostatmanual.com>

Golf course search by state

<http://golfingnear.com>

Email search by domain

<http://emailbydomain.com>

Auto manuals search

<http://auto.somanuals.com>

TV manuals search

<http://tv.somanuals.com>