

***Directed***<sup>®</sup>  
**AUDIO**

OWNER'S  
MANUAL



models | **750d**  
**1500d**

## **CONGRATULATIONS**

Congratulations for choosing a Directed Audio power amplifier from Directed Electronics, the industry leader in high quality automotive security and audio equipment since 1990.

Directed Audio power amplifiers continue to set new standards of performance, reliability, and affordability in the mobile electronics industry.

Featuring high-efficiency MOSFET power supplies, flexible on-board crossovers, and state of the art audio design, Directed Audio power amplifiers will excite and delight the mobile sound

enthusiast with years of high-quality audio reproduction.

Directed Audio power amplifiers come with a two-year limited warranty if installed by an authorized Directed dealer. If not installed by an authorized dealer, Directed Audio power amplifiers are covered by a one-year, parts-and-labor limited warranty.

Be sure to retain your original sales receipt and refer to the warranty section of this guide for full details about your coverage.

## **TABLE OF CONTENTS**

Limited Two-Year Consumer Warranty .....	3
Features .....	4
Warning .....	4
Installation Guidelines .....	5
Front Panel Connections .....	7
Rear Panel Connections .....	8
Top Panel Controls .....	10
Top Panel Features .....	10
Speaker Wiring Diagrams .....	11
Combining Amplifiers .....	12
Parallel Synced Gain Connections/Settings .....	13
External Synced Bridged Connections/Settings .....	15
Multiple Amplifier Combinations .....	17
Crossover Settings and Gain Adjustment .....	18
Specifications .....	19

## **LIMITED TWO-YEAR CONSUMER WARRANTY**

Directed Electronics, Inc. promises to the original purchaser, to replace this product should it prove to be defective in workmanship or material under normal use, for a period of two years from the date of purchase by the dealer as indicated by the date code marking of the product **PROVIDED** the product was installed by an authorized Directed dealer. During this two-year period, there will be no charge for this replacement **PROVIDED** the unit is returned to Directed, shipping pre-paid. If the unit is installed by anyone other than an authorized Directed dealer, the warranty period will be one year from the date of purchase by the dealer as indicated by the date code marking of the product. During this one-year period there will be no charge for this replacement **PROVIDED** the unit is returned to Directed, shipping pre-paid. This warranty is non-transferable and does not apply to any unit that has been modified or used in a manner contrary to its intended purpose, and does not cover damage to the unit caused by installation or removal of the unit. This warranty is void if the product has been damaged by accident or unreasonable use, neglect, improper service or other causes not arising out of defects in materials or construction. **ALL WARRANTIES INCLUDING BUT NOT LIMITED TO EXPRESS WARRANTY, IMPLIED WARRANTY, WARRANTY OF MERCHANTABILITY, FITNESS FOR PARTICULAR PURPOSE, AND**

**WARRANTY OF NON-INFRINGEMENT OF INTELLECTUAL PROPERTY ARE EXPRESSLY EXCLUDED TO THE MAXIMUM EXTENT ALLOWED BY LAW, AND DIRECTED NEITHER ASSUMES NOR AUTHORIZES ANY PERSON TO ASSUME FOR IT ANY LIABILITY IN CONNECTION WITH THE SALE OF THE PRODUCT. DIRECTED HAS ABSOLUTELY NO LIABILITY FOR ANY AND ALL ACTS OF THIRD PARTIES INCLUDING ITS AUTHORIZED DEALERS OR INSTALLERS.** Unit must be returned to Directed, postage pre-paid, with: consumer's name, telephone number, and address, authorized dealer's name and address, and product description. **IN ORDER FOR THIS WARRANTY TO BE VALID, YOUR UNIT MUST BE SHIPPED WITH PROOF OF INSTALLATION BY AN AUTHORIZED DIRECTED DEALER. ALL UNITS RECEIVED BY DIRECTED FOR WARRANTY REPAIR WITHOUT PROOF OF DIRECTED DEALER INSTALLATION WILL BE COVERED BY THE LIMITED ONE-YEAR PARTS AND LABOR WARRANTY.** **Note:** This warranty does not cover labor costs for the removal and reinstallation of the unit. **BY PURCHASING THIS PRODUCT, THE CONSUMER AGREES AND CONSENTS THAT ALL DISPUTES BETWEEN THE CONSUMER AND Directed SHALL BE RESOLVED IN ACCORDANCE WITH CALIFORNIA LAWS IN SAN DIEGO COUNTY, CALIFORNIA.**

## FEATURES

- Super-efficient Class D PWM design runs much cooler than conventional amps.
- High-speed MOSFET switching power supply.
- High-current complimentary MOSFET outputs stable into one ohm loads.
- Thermal, DC offset, reverse polarity, and short circuit protection with status LED.
- Master/slave RCA jack functions support two amps bridged to one load.
- Top-mounted controls easily accessed for system tuning.
- Continuously variable 18 dB/octave low-pass crossover.
- Switchable 30 Hz, 24 dB/octave subsonic filter.
- Switchable 8 dB bass EQ function.
- Switchable phase adjustment.
- Remote subwoofer level control supplied.
- Variable input sensitivity optimizes match with different signal sources.
- Gold-plated wire terminals and RCA connectors ensure maximum signal transfer.
- Rugged one-piece extruded heat sink finished with injection-molded mounting feet.

## WARNING



High-powered car audio systems may produce sound pressure levels that exceed the threshold at which hearing loss may result.

They may also impair a driver's ability to hear traffic sounds or emergency vehicles. Use common sense and practice safe listening habits when listening to or adjusting your audio system.

## INSTALLATION GUIDELINES

1. Please read this owner's manual carefully before installing this amplifier.
2. Disconnect the battery ground terminal prior to making any electrical connections.
3. Check for any hazards or obstructions such as gas tanks, fuel or brake lines, and wiring harnesses before mounting the amplifier.
4. Pick a mounting location that will provide adequate access and ventilation and protect the amplifier from heat, moisture, and dirt.
5. Avoid sharp metal areas when routing cables to the amplifier, and run RCA cables away from the power cables and other potentially noisy car harnesses.
6. The amplifier should be grounded with a short, heavy gauge wire connected directly to the car at a bare metal surface, preferably scraped body sheet metal. Do not use factory ground locations, seat bolts, or brackets that are spot welded.
7. Always fuse your power connection within 8 to 10 inches of the battery terminal. Use a fuse or circuit breaker rated slightly more than the on-board fuse(s) of the amplifier(s). The gauge of power wire used should take into account the total current draw of the system, and the length of wire used. IASCA and other auto sound competition organizations have charts available for this; you can also find a chart in the MECP study guide. Minimum wire gauge recommendations for the individual amplifiers are listed on the specification page. Always use the same gauge wire for the amplifier ground that you use for the power wire. Be sure to examine the battery ground cable of the vehicle, and if necessary, upgrade it by adding an additional ground wire that is the same gauge as the amplifier's power wire. Remember, the amplifier can only deliver its rated output when it is not current limited by the power and ground supply wires.
8. This amplifier is designed to drive a speaker load that measures from 1 to 4 ohms. Keep in mind that heat is the long-term enemy of automotive electronics and the lower your

speaker load, the more heat is generated. For low impedance speaker applications or restricted ventilation installations, an external cooling fan may be advisable.

9. Battery and ground connections to the vehicle should be made with crimped ring terminals of the appropriate size (surface area is what counts); soldering the terminals after crimping is also recommended.
10. Due to the high-frequency MOSFET switching power supply, filtering the power cable is not generally required (remember that the amp can't deliver full output if the power supply is restricted). Proper grounding of the signal source is mandatory for the amplifier to reach its performance peak. If the RCA inputs are not grounded adequately via the signal source, electrical noise from the vehicle may be picked up in the system.

## FRONT PANEL CONNECTIONS

1. **RCA Input Jacks** - Accepts line level outputs from head units or signal processors at voltages between 150mV and 8 volts.
2. **RCA Sync Out/ Slave In Jack**

Sync Out - This RCA jack sends a Synced or in-phase gain matched output signal to a slave amplifier when connected in the Parallel Synced Gain combination. It is a Synced output when the slave/master switch is in the MASTER position only.

Slave In - This RCA jack accepts input from a master amplifier. It is for use in the Parallel Synced Gain and External Synced Bridged combinations. It is a slave input when the slave/master control switch is in the SLAVE position only.
3. **RCA Bridge Output Jack** - This output sends an out-of-phase signal to a slave amplifier when connected in the External Synced Bridged combination. (Refer to the *Combined Amplifiers* section of this guide)
4. **Slave/Master Switch** - Controls whether the amplifier is a slave or master when connected in combined amplifier configurations. (Refer to the *Combined Amplifiers* section of this guide.)
5. **Remote Sub Level Control** - Controls the subwoofer amplifier gain controls from a remote location for ease of adjustment during listening.

**Warning:** DO NOT connect a level control knob from other manufacturers to the Remote Sub Level Control of any Directed amplifier. Even though the connectors fit properly, the control knob and connector pin positions may be different and the amplifier will be damaged.

FIGURE 1—AMPLIFIER CONNECTIONS 750d/1500d FRONT

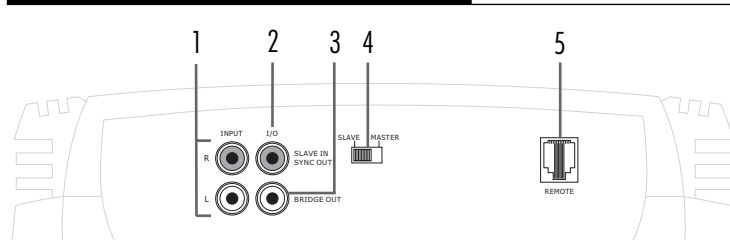

## REAR PANEL CONNECTIONS

1. **Sub Out Terminals** - Connect subwoofers to these terminals. (Refer to the *Speaker Wiring Diagrams* section of this guide.)
2. **Status LEDs** - The Power LED will light GREEN to indicate the amplifier is on and operating normally. The GREEN LED will turn off and the Protection LED will light RED when the amplifier has shut itself down due to speaker short circuit, DC offset or overheating.
3. **Power Fuses** - These fuses protect the amplifier against internal electrical damage and are meant to protect the amplifier only. All other power connections should be fused at the source.
4. **(+) 12 Volt Power** - Connect this terminal through a FUSE or CIRCUIT BREAKER to the positive terminal of the vehicle battery or the positive terminal of an isolated audio system battery.
5. **Remote Turn On** - This terminal turns on the amplifier when (+) 12 volt is applied to it. Connect it to the remote turn on lead of the head unit or signal source. If a (+) 12 volt remote turn on lead is not available, Remote Power Adapter (P/N #55000) can be used to supply a remote turn on signal. DO NOT connect this terminal to constant (+) 12 volt.
6. **Ground** - Connect this terminal directly to the sheet metal chassis of the vehicle, using the shortest wire necessary to make this connection. Always use wire of the same gauge or larger than the (+) 12 volt power wire. The chassis connection point should be scraped free of paint and dirt. Use only quality crimped and/or soldered connectors at both ends of this wire. DO NOT connect this terminal directly to the vehicle battery ground terminal or any other factory ground points.

**WARNING:** Always protect this power wire by installing a fuse or circuit breaker of the appropriate size within 12 inches of the battery terminal connection.



**FIGURE 2—AMPLIFIER CONNECTIONS 750d REAR**

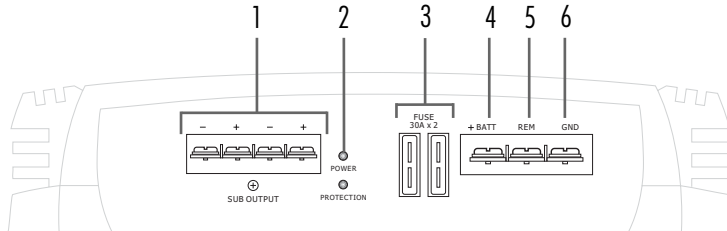

**FIGURE 3—AMPLIFIER CONNECTIONS 1500d REAR**

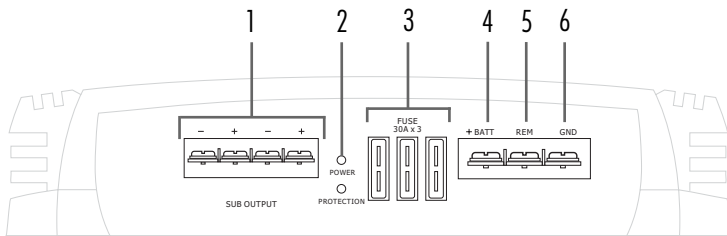

## TOP PANEL CONTROLS

1. **Input Gain Adjustment** - Controls the amplifier's sensitivity and is used to match the input level of the amplifier to the output level of the signal source.
2. **Crossover Frequency Adjustment** - Adjusts the crossover point for the on-board low-pass crossover.
3. **Subsonic Frequency Switch** - Sets the cutoff point for subsonic frequencies below 30Hz. Frequencies below 30Hz will be attenuated by 24db per octave.
4. **Bass EQ Switch** - Adds 8db of additional boost to the subwoofer output when active.
5. **Sub Phase Switch** - Changes the phase of the subwoofer output by 180 degrees.

FIGURE 4—AMPLIFIER CONTROLS TOP

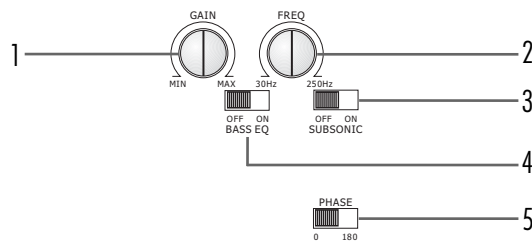

## TOP PANEL FEATURES

### Control Panel Cover

The gain and filter controls are located under a control panel cover on top of the amplifier. The control panel cover must be removed to gain access to the gain and filter controls.

### Remove/Install

Four Allen-head screws hold the control panel cover to the amplifier top panel, one at each corner. They can be removed with the wrench supplied in the hardware pack.

## **SPEAKER WIRING DIAGRAMS**

### **Single subwoofer connection** (top view)

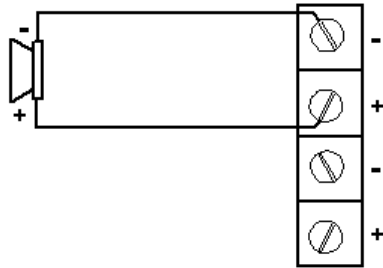

### **Two subwoofer connection** (top view)

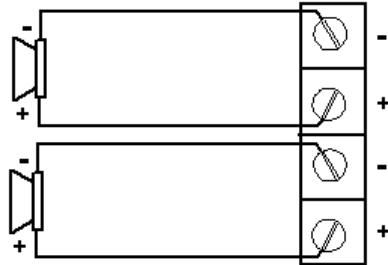

**NOTE:** The dual + and - sub-out terminals of the 750d/1500d are paralleled internally and the combined load impedance should be taken into consideration when connecting multiple subwoofers.

## COMBINING AMPLIFIERS

The Viper 750d/1500d subwoofer amplifiers have the capability of connecting two or more amplifiers of the same power rating together in a master/slave combination for increased power with accurate level matching. They are the Parallel Synced Gain and External Synced Bridged combinations.

**WARNING:** DO NOT attempt to combine amplifiers of different power ratings. These amplifier combinations work correctly only if the Master and Slave amplifiers are identical models.

### Parallel Synced Gain

In this master/slave combination the master amplifier pre-amp controls remain active and the slave amplifier pre-amp is bypassed. This allows the master amplifier to control gain, filter, and sub-level on both amplifiers.

This combination allows the amplifiers to drive their own separate subwoofer(s) while being synced together via an in-phase audio pre-amp signal from the master amplifier. Wiring connections to the amplifier subwoofer outputs in this combination should be standard in-phase configurations, creating a parallel speaker connection. (Refer to *Parallel Synced Gain* section of this guide for amplifier and speaker connection diagrams.)

**NOTE:** One master amplifier can control up to three slave

amplifiers in this combination. Multiple identical master/slave combinations can be added to any given system.

### External Synced Bridged

In this master/slave combination the master amplifier pre-amp controls remain active and the slave amplifier pre-amp is bypassed. This allows the master amplifier to control gain, filter, and sub-level on both amplifiers. This combination allows the amplifiers to drive common subwoofer loads while being synced together via an out-of-phase audio pre-amp signal from the master amplifier. In this subwoofer wiring configuration the master amplifier sends the positive signal to the subwoofer while the slave amplifier sends the negative signal, making an externally bridged speaker connection. (Refer to *External Synced Bridged* section of this guide for amplifier and speaker connection diagrams.)

**NOTE:** Amplifiers in this combination can only be connected in matched pairs. Multiple matched pairs may be added to drive separate subwoofer loads in a given system.

### Combined Amplifiers Gain and Filter Settings

Set the Subsonic, EQ, and other filter settings on the master amplifier to the positions that achieve the best sound quality. Adjustment guidelines are discussed in the *Crossover and Gain Adjustment* section of this guide.

## **PARALLEL SYNCED GAIN CONNECTIONS/SETTINGS**

1. **Input Signal** - Connect these RCA jacks as described in the *Front Panel Connection* section of this guide.
2. **Slave/Master Switch**
  - Set the slave/master switch on the master amplifier to the MASTER position.
  - Set the slave/master switch on the slave amplifier to the SLAVE position.
  - Setting the slave/master switch on both amplifiers will automatically set the I/O RCA jack configuration according to each amplifier's slave or master designation.
3. **Remote Sub Level Control** - Connect the Remote Sub Level Control to the master amplifier only. The master amplifiers subwoofer gain is used to set the overall gain for all synced amplifiers, then the Remote Sub Level Control can adjust the gain of all synced amplifiers.
4. **Signal Connection** - Connect an RCA cable between the SYNC OUT RCA jack of the master amplifier and the SLAVE IN RCA jack of the slave amplifier as shown in the Figure 5.
5. **Subwoofer Speaker Connection** - In this amplifier combination each amplifiers must drive its own separate subwoofer(s). Connect the speaker terminals of each amplifier to any combination of one or more subwoofers that results in nominal impedance between one and four ohms. Make sure that each amplifier sees the same speaker impedance.

**NOTE:** One master amplifier can control up to three slave amplifiers in this combination. Multiple identical master/slave combinations can be added to any given system.

FIGURE 5—PARALLEL SYNC GAINED 750d/1500d

**Master**

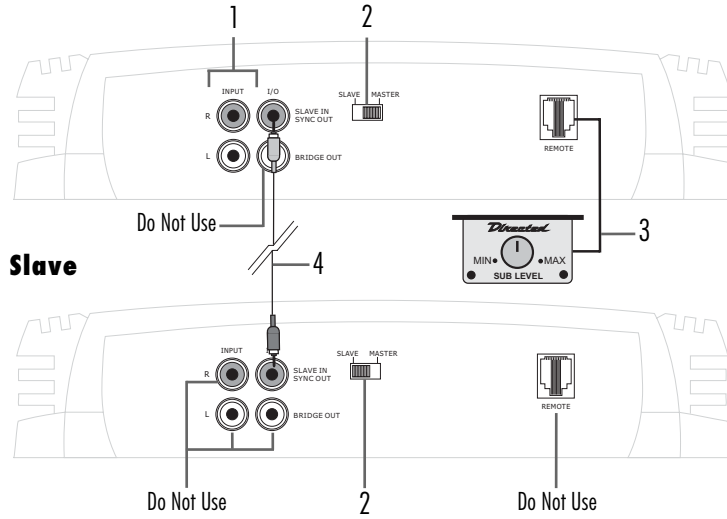

**Subwoofer Wiring (top view)**

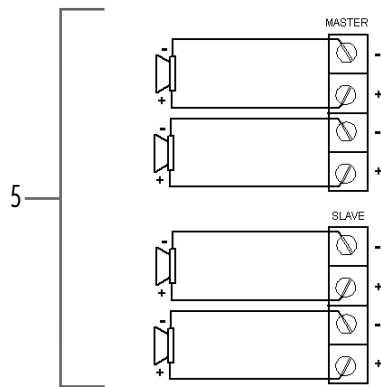

**NOTE:** The dual + and - subout terminals of the 750d/1500d are paralleled internally and the combined load impedance should be taken into consideration when connecting multiple subwoofers.

## **EXTERNAL SYNCED BRIDGED CONNECTIONS/SETTINGS**

1. **Input Signal** - Connect these RCA jacks as described in the *Front Panel Connection* section of this guide.
2. **Slave/Master Switch**
  - Set the slave/master switch on the master amplifier to the MASTER position.
  - Set the slave/master switch on the slave amplifier to the SLAVE position.
  - Setting the slave/master switch on both amplifiers will automatically set the I/O RCA jack configuration according to each amplifiers slave or master designation.
3. **Remote Sub Level Control** - Connect the Remote Sub Level control to the master amplifier only. The master amplifier gain control is used to set the overall gain for both amplifiers, and then the Remote Sub Level control can adjust the gain of both amplifiers.
4. **Signal Connection** - Connect an RCA cable between the BRIDGE OUT RCA jack of the Master amplifier and the SLAVE IN RCA jack of the Slave amplifier as shown in Figure 6.
5. **Subwoofer Speaker Connection** - In this amplifier combination the Subwoofer speaker terminals of both amplifiers drive common subwoofer(s). Use the following speaker connection diagram when connecting the subwoofers to the amplifiers. Connect the amplifiers speaker terminals to any combination of one or more subwoofers that results in a nominal impedance between 2 and 4 ohms. DO NOT connect loads of less than 2 ohms when connecting to amplifiers in the External Synced Bridged combination.

**NOTE:** Amplifiers in this combination can only be connected in matched pairs. Multiple matched pairs may be added to drive separate subwoofer loads in a given system.

**WARNING:** Two wires of 12AWG minimum must be connected between the negative sub out terminals of the master and slave amplifiers.

FIGURE 6—EXTERNAL SYNC BRIDGED 750d/1500d

**Master**

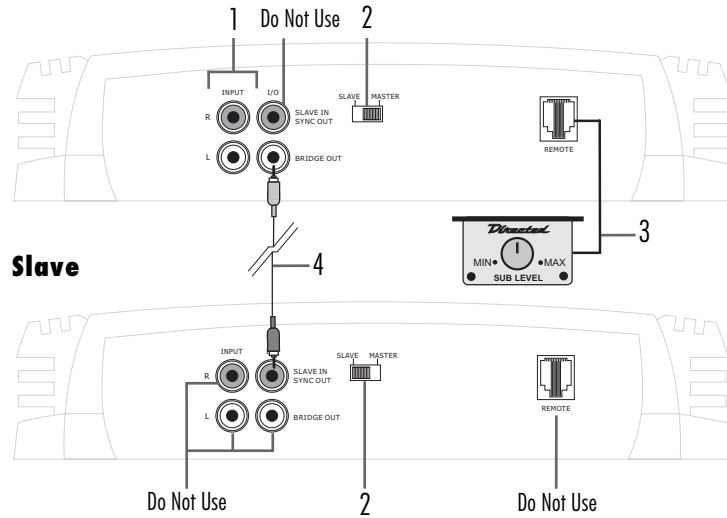

**Subwoofer Wiring**

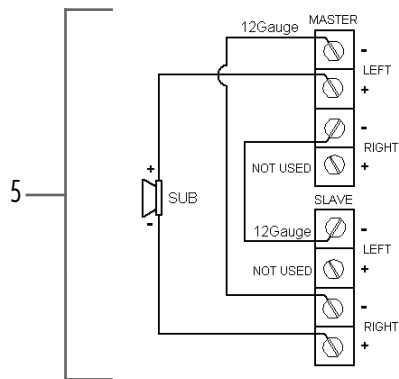

**NOTE:** The dual + and - subout terminals of the 750d/1500d are paralleled internally and the combined load impedance should be taken into consideration when connecting multiple subwoofers.  
The audio signal to the slave amplifier is 180° out of phase. The subwoofer's negative terminal must be connected to the slave amplifier's positive terminal.



## **MULTIPLE AMPLIFIER COMBINATIONS**

The Directed 750d/1500d subwoofer amplifiers can also be used in multiples of the master/slave combinations allowing for unlimited expansion to a systems subwoofer section. To use multiples of amplifier combinations the following directions must be adhered to for best results.

- **Audio signal** - Divide the head unit or processor audio signal to the master amplifiers by using RCA Y adapters. Be sure to divide them an even number of times to ensure the input level at each master amplifier is matched.
- **Remote Sub Level Control** - The Remote Sub Level Control cable can be divided several times to connect to each master amplifier. This can be accomplished by using one or

more Directed Remote Sub Level cable splitters. Standard single-to-double phone line splitters and accessories from a local electronics store can also be used.

For systems with more than two master/slave combinations, use multiple single-to-double splitters. Do not use phone splitters that divide the signal more than once per splitter, or splitters designed for multiple uses.

- **Amplifier configuration** - Set up each master/slave amplifier combination as described for the combination type being used. (Refer to the *Parallel Synced Gain* or the *External Synced Bridged* section of this guide for amplifier and speaker connection descriptions.)

## **CROSSOVER SETTINGS AND GAIN ADJUSTMENT**

Your Directed Audio power amplifier needs to be adjusted carefully to achieve maximum performance. These are some guidelines to follow when fine-tuning the amplifier.

- Because this amplifier is only designed for subwoofer applications, the low-pass crossover is active at all times. The crossover point is adjustable to allow more precise system operation.
- Try and keep the setting low enough to prevent image smearing (you should not be able to hear male voices from the subwoofer) but not so low as to create a gap between the subwoofer and the mid-bass/midrange speakers. It will be to your advantage to spend some extra time with this adjustment, listening to familiar music or system set-up discs to achieve the kind of musical reproduction that you prefer.
- The gain adjustment allows you to set proper signal match for clean, quiet amplifier operation. Start by playing some music you are familiar with. With the gain adjustment on the amplifier in the middle of its rotation, bring up the volume on your head unit to the 3/4 volume setting or until you start to hear distortion or clipping. If you hear distortion before you reach the 3/4 volume setting of your head unit, reduce the gain setting on the amplifier and start to raise the head unit volume again. When you can listen to the music at or slightly above 3/4 on your head unit without audible distortion, slowly raise the gain of the amplifier until distortion is heard, then back off the gain until the distortion is not audible. This setting will allow you to reach full output with all but the quietest of source material, while avoiding excessive noise in the system.
- For systems using the Remote Sub Level Adjustment, increase the subwoofer gain on the amplifier by 25% and set the Remote Sub Level knob to the center position after making all system gain and filter adjustments. This will give the Remote Sub Level Control a wider range of adjustment to the subwoofer output.
- You should take into consideration the effect that gain adjustment has on system frequency response and staging. Again, plan on spending some time with music that you know getting the gain and crossover settings the way you like. Test discs and analyzers may help with this process, but in the end it's your ears that count—listen to the music!

## SPECIFICATIONS

	<b>Directed model</b>	<b>750d</b>	<b>1500d</b>
<b>RMS continuous power</b> driven into 4 ohms from 20 to 250 Hz @ 14.4 VDC at rated power/load.		275 watts 0.4% THD	425 watts 0.5%
<b>RMS continuous power</b> driven into 2 ohms from 20 to 250 Hz @ 14.4 VDC at rated power/load.		400 watts 0.6% THD	800 watts 0.7%
<b>RMS continuous power</b> driven into 1 ohm from 20 to 250 Hz @ 14.4 VDC at rated power/load.		600 watts 0.8% THD	1100 watts 0.9%
<b>Dynamic power rating</b> (IHF-202 Standard) minimum load.		750 watts	1500 watts
<b>RMS continuous power</b> driven into 4 ohms from 20 to 250 Hz @ 14.4 VDC in synced bridge mode (bridged pair).		800 watts	1600 watts
<b>RMS continuous power</b> driven into 2 ohms from 20 to 250 Hz @ 14.4 VDC in synced bridge mode (bridged pair).		1200 watts	2200 watts
Signal-to-Noise Ratio		Greater than 80 dB	
Frequency Response		20-250 Hz +0, -1 dB	
Damping Factor		50 (typical)	
Crossover		Low-pass 18 dB/octave, variable from 30 to 250 Hz	
Subsonic Filter		Switchable 30 Hz, 24 dB/octave	
Bass Equalization		Switchable 8 dB, centered at 40Hz	
Input Impedance		20K ohms	
Input Sensitivity		Variable from 150 mV to 8 volt	
Output Impedance		1 to 4 ohms	
Supply Voltage		10 to 16 VDC	
Fusing and Power		60A	90A
Minimum Cable Requirements (AWG) (Per amp, trunk mounted)		#8	#4



Directed Electronics, Inc.  
Vista, California 92081  
[www.directed.com](http://www.directed.com)

The company behind this system is Directed Electronics, Inc. Since its inception, Directed has had one purpose, to provide customers with the finest vehicle security, car stereo products, rear seat entertainment, and accessories available. The recipient of more than 20 patents in the field of advanced electronic technology, Directed is ISO 9001 registered.

**Directed® is committed to delivering world-class quality products and services that excite and delight our customers.**



Directed is a proud member of



Quality Directed products are sold and serviced throughout North America and around the world  
Call **800 274 0200** for more information about our products and services

© 2003 Directed Electronics, Inc. - All rights reserved - G45013/15 11/03

## Free Manuals Download Website

<http://myh66.com>

<http://usermanuals.us>

<http://www.somanuals.com>

<http://www.4manuals.cc>

<http://www.manual-lib.com>

<http://www.404manual.com>

<http://www.luxmanual.com>

<http://aubethermostatmanual.com>

Golf course search by state

<http://golfingnear.com>

Email search by domain

<http://emailbydomain.com>

Auto manuals search

<http://auto.somanuals.com>

TV manuals search

<http://tv.somanuals.com>