

Automate[®]
V I D E O

OWNER'S GUIDE

INSTALLATION GUIDE



7" Mobile Video System

MODEL OHD070A

© 2004 Directed Electronics, Inc. N83070A 12-04

NON-TRANSFERABLE LIMITED CONSUMER WARRANTY

.....

Directed Electronics, Inc. (Directed) promises to the original purchaser that the automotive video monitor and/or source unit(s) (the Product), excluding accessories, purchased and installed from a Directed authorized dealer within ninety (90) days after purchase of the new vehicle, in which the Product is installed, will be free from defects in materials or workmanship under normal use and conditions for a period of three (3) years from date of purchase or the first 36,000 miles as registered on the new vehicle's odometer reading at time of delivery of the Product for warranty service, whichever occurs first. Product purchased or installed more than ninety (90) days after the new vehicle is purchased are warranted for a period of one (1) year from date of purchase of the Product.

Directed promises to the original purchaser that all video accessories will be free from defects in materials and workmanship under normal use and condition for a period of ninety (90) days after the date of purchase. A sales receipt and/or warranty registration card is required to provide proof of date of purchase of the Product or accessories.

Should the Product prove to be defective during the applicable warranty period, the Product will be repaired or replaced with a new or comparable reconditioned part(s), at Directed's election. To obtain warranty service, the Product must be returned to a Directed authorized dealer along with proof of purchase and proof of installation by an Authorized Directed Dealer.

This warranty is non-transferable and does not apply to any Product that has been modified or used in a manner contrary to its intended purpose, and does not cover damage to the Product caused by installation or removal of the Product. This warranty is VOID if the product has been damaged by accident or unreasonable use, negligence, acts of God, neglect, improper service or other causes not arising out of defect in materials or construction. This warranty does not cover the elimination of externally generated static or noise, or the correction of antenna problems or weak television reception, damage to tapes, video games, software, camcorders, discs, speakers, accessories or vehicle electrical systems, cosmetic damage or damage due to negligence, misuse, abuse, failure to follow operating instructions, accidental spills or customer applied cleaners, damage due to environmental causes such as floods, airborne fallout, chemicals, salt, hail, windstorms, lightning or extreme temperatures, damage due to accidents, road hazards, fire, theft, loss or vandalism, damage due to improper connection to equipment of another manufacturer, modification of existing equipment, use of a faulty tape cartridge or cleaning of the VCR head, or Product which has been opened or tampered with for any reason or which has been damaged due to alteration or service performed by anyone other than Directed Electronics, Inc.

ALL WARRANTIES INCLUDING BUT NOT LIMITED TO EXPRESS WARRANTY, IMPLIED WARRANTY, WARRANTY OF MERCHANTABILITY, FITNESS FOR PARTICULAR PURPOSE, AND WARRANTY OF NON-INFRINGEMENT OF INTELLECTUAL PROPERTY ARE EXPRESSLY EXCLUDED TO THE MAXIMUM EXTENT ALLOWED BY LAW, AND DIRECTED NEITHER ASSUMES NOR AUTHORIZES ANY PERSON TO ASSUME FOR IT ANY LIABILITY IN CONNECTION WITH THE SALE OF THE PRODUCT. DIRECTED HAS ABSOLUTELY NO LIABILITY FOR ANY AND ALL ACTS OF THIRD PARTIES INCLUDING ITS LICENSED DEALERS OR INSTALLERS. IN NO EVENT WILL DIRECTED ELECTRONICS, INC. BE LIABLE FOR ANY INCIDENTAL, SPECIAL OR CONSEQUENTIAL DAMAGES (INCLUDING LOSS OF PROFITS), BY PURCHASING THIS PRODUCT, THE CONSUMER AGREES AND CONSENTS THAT ALL DISPUTES BETWEEN THE CONSUMER AND DIRECTED SHALL BE RESOLVED IN ACCORDANCE WITH CALIFORNIA LAWS IN SAN DIEGO COUNTY, CALIFORNIA.

Some states do not allow limitation on how long an implied warranty lasts. In such states, the limitations or exclusions of this Limited Warranty may not apply. Some states do not allow the exclusion or limitation of incidental or consequential damages. In such states, the exclusion or limitation of this Limited Warranty may not apply to you. This Limited Warranty gives you specific legal rights, and you may have other rights which vary from state to state.

Table of Contents

Non-Transferable Limited Consumer Warranty2
Safety Information4
Important Notes5
What is Included6
Introduction6
Your Warranty7
Supported Disc Formats7
Installation8
Preliminary Preparations8
Mounting Video System8
Electrical Connections10
Video System Controls and Description11
Remote Control13
Functions13
Battery Replacement15
Using the Remote Control15
Operation16
Loading/Ejecting a Disc16
Stopping Play16
Rapid Forward/Reverse16
Skipping Track17
Slow Motion Play17
Pause17
Mute17
Repeat18
A-B18
Disc Search (GOTO)18
Zoom19
Random19
Program19
Mode Selection19
Volume Level Adjustment19
Light Switch20
Jack for Earphone20
Earphone Volume Adjustment20
Remote Sensor (IR)20
Turning the Unit ON/OFF20
Monitor Release20
Infrared Transmitting Window20

LCD Menu Operations21
Menu.....	.21
Transmit21
Screen21
Search21
On Screen Displays22
Display22
Multi-Audio Language Function25
Title Menu Function.....	.26
Multi-Subtitle Language Function26
Multi--Angle Function26
MP3 Disc Play.....	.27
TV Operation27
Setup28
Initial Setup28
General Setup.....	.29
Speaker Setup32
Audio Setup33
Preferences Setup (including parental)35
Factory Default Setting41
Appendix A – Cleaning42
Cleaning the LCD Screen42
Cleaning the Enclosure.....	.42
Cleaning and Handling Discs.....	.42
Appendix B – Troubleshooting44
Appendix C – Specifications46

Safety Information

To reduce the risk of fire or electric shock, do not expose this equipment to rain or moisture.

The mobile DVD player is a Class I laser product. This mobile DVD player uses a laser beam which could cause vision damage. Do not open the covers to this unit, there are no owner serviceable parts inside.

Important Notes

NOTE: The parental level control is discussed in the Preferences Setup section of this manual.

1. Before operating your LCD Monitor system, please read these instructions carefully.
2. Retain this manual for future reference.
3. Do not remove any WARNING stickers on the unit.
4. When the power to the unit is shut off, the next time the unit is turned on the speakers will **not** operate. The Transmit feature must be reset to OFF (IR headphones off) in the setup features.
5. Do not use any chemical solvent, cleaning agent or corrosive detergent to clean away dirt on the surface of the screen. Doing so may cause irreversible damage to the surface of the LCD screen. To clean off dirt or fingerprints, it is recommended that a soft-damp lens cleaning cloth be used.
6. Using spare parts from another manufacturer may cause permanent damage to the unit.
7. If using the surface mount pedestal, ensure that the pedestal mount is placed on a flat, hard, and stable surface.
8. Avoid installing the monitor screen in a position that is under direct sunlight and away from hot air vents.
9. Install the unit in a dry location, avoid condensation.
10. Ensure the plugs are properly plugged in before operating the unit.
11. Should the LCD panel break, avoid contact with the broken glass or fluid leaking out from the enclosure. If you come into contact, flush and clean the affected areas with plenty of water. Seek medical attention immediately.
12. When operating the display unit, avoid touching or pressing on the LCD screen. Excessive force will damage the LCD screen.
13. When installing this unit in a vehicle, ensure that the installation and use of this unit is in compliance with local vehicle rules and regulations.
14. Do not attempt to disassemble or adjust this product. Contact your factory authorized dealer for service assistance.
15. Avoid inserting any foreign objects into the slot of this player. Failure to observe this caution may cause the unit to malfunction.
16. This product is designed to operate with a 12 volt DC, negative ground battery system.
17. While Driving, keep the volume level low enough to be aware of road and traffic conditions.
18. The unit should be installed in a horizontal position with the front end up at a convenient angle, but not more than 30 degrees.

What is Included

- 7" Overhead Monitor/DVD Player
- Mounting hardware
- Metal mounting plate
- Mounting bracket
- Remote Control Unit/w battery
- Rubber plate

Introduction

Congratulations on your purchase of the world's finest video entertainment system. At Directed we are committed to bringing you the most technologically advanced products available. We are pleased that you chose an Automate Video product. Through years of critical testing and hand craftsmanship, we have created a wide range of video entertainment products for your viewing pleasure.

This system incorporates the use of on screen display menu controls that allow you to configure the system to suit your own personal preferences.

To view other great products from Directed Electronics, please visit the Directed Video page at www.directed.com.

Your Warranty

Your warranty registration must be completely filled out and returned within 10 days of purchase. Your product warranty will not be validated if your warranty registration is not returned. Make sure you receive the warranty registration from your dealer. It is also necessary to keep your proof of purchase, which reflects that the product was installed by an authorized dealer.

Supported Disc Formats

The following disc formats are supported by this player.



DVD
12 cm disc
(Single-sided disc only)



Video CD
12 cm disc



CD
12 cm disc



MP3
12 cm disc

The following disc formats are **NOT** supported by this player.

DVD-ROM	CDV
DVD-R/DVD-RAM	CD-G

Installation

PRELIMINARY PREPARATIONS

NOTE: The unit should be installed by a qualified service technician. This unit is designed to operate with a 12 VDC, negative ground battery system.

NOTE: Use only proper sized fasteners and cables during installation. Use of improper fasteners or cables can lead to mechanical failure of the unit or create a fire hazard.

1. Disconnect the ground wire from the battery terminal prior to connecting the unit to the electrical system.

NOTE: Some vehicle radios have an anti-theft code system that will disable the radio if the battery is disconnected. If this vehicle has such a radio, ensure you have the access code to restore the radio to normal operation.

2. Pick a location to install the monitor where it will not obstruct the rear view mirror or the air conditioning vents.
3. Do not install this unit at an angle exceeding 30 degrees.

MOUNTING VIDEO SYSTEM

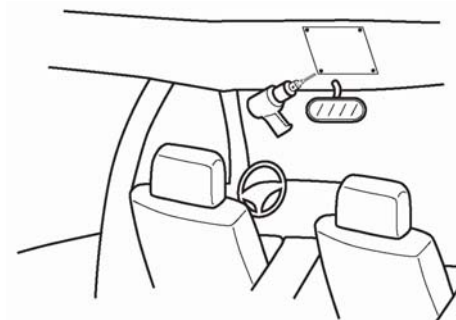

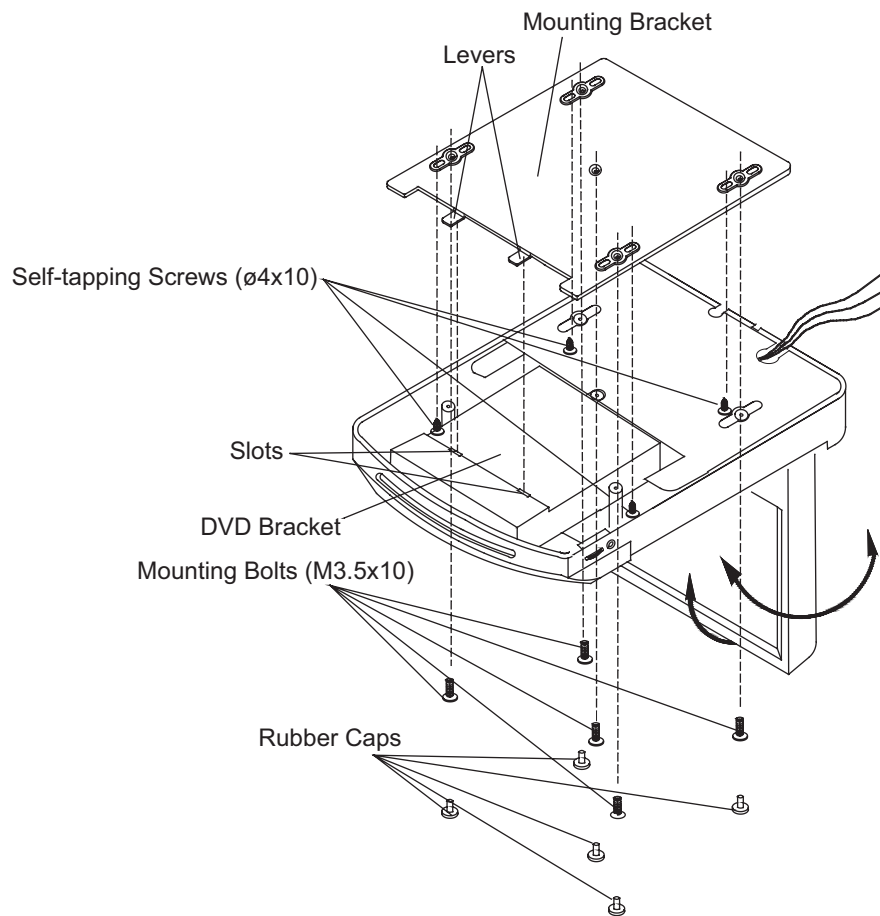

1. Determine the mounting location and drill four mounting holes (see the figure above).
2. Attach the mounting bracket to the holes with the self-tapping screws ($\varnothing 4 \times 10$).
3. Let the two levers aim at the slots on the DVD bracket to fix the display unit.
4. Open the monitor to display the five screw holes.
5. Attach the unit to the bracket with the mounting bolts (M 3.5x10).
6. Insert five rubber caps into the screw holes.
7. When the installation has completed, you can turn the display upward or downward, left or right to adjust the viewing angle. (See the arrowhead symbol in the figure above).

ELECTRICAL CONNECTIONS

POWER AND VIDEO WIRING

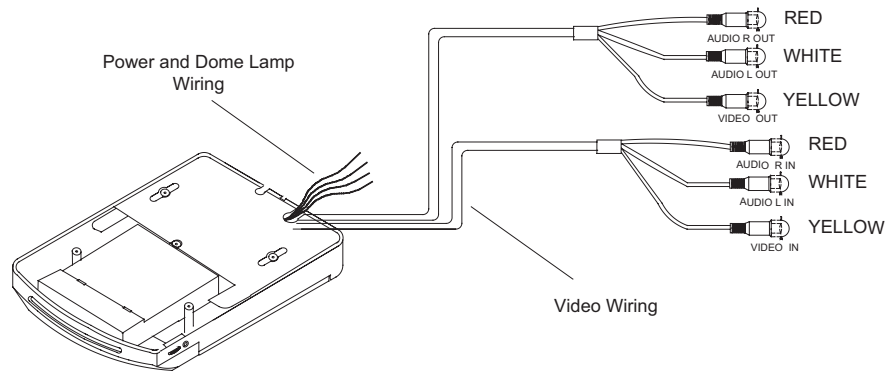

Connect the power and dome light wires as follows:

Color	Connection
Red	Accessory
Yellow	Battery +12V
White	Interior Light System (Dome -)
Orange	Interior Light System (Dome +)
Black	Ground

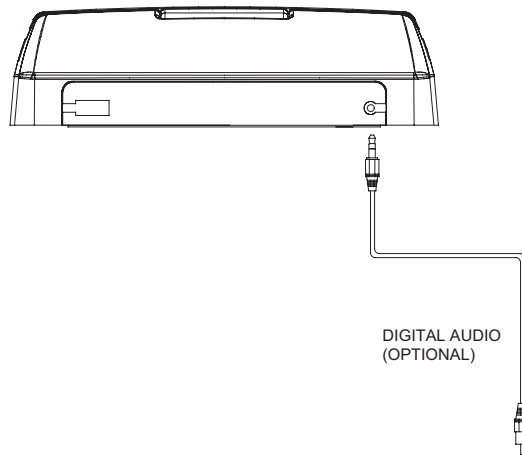

OPTIONAL DIGITAL WIRING

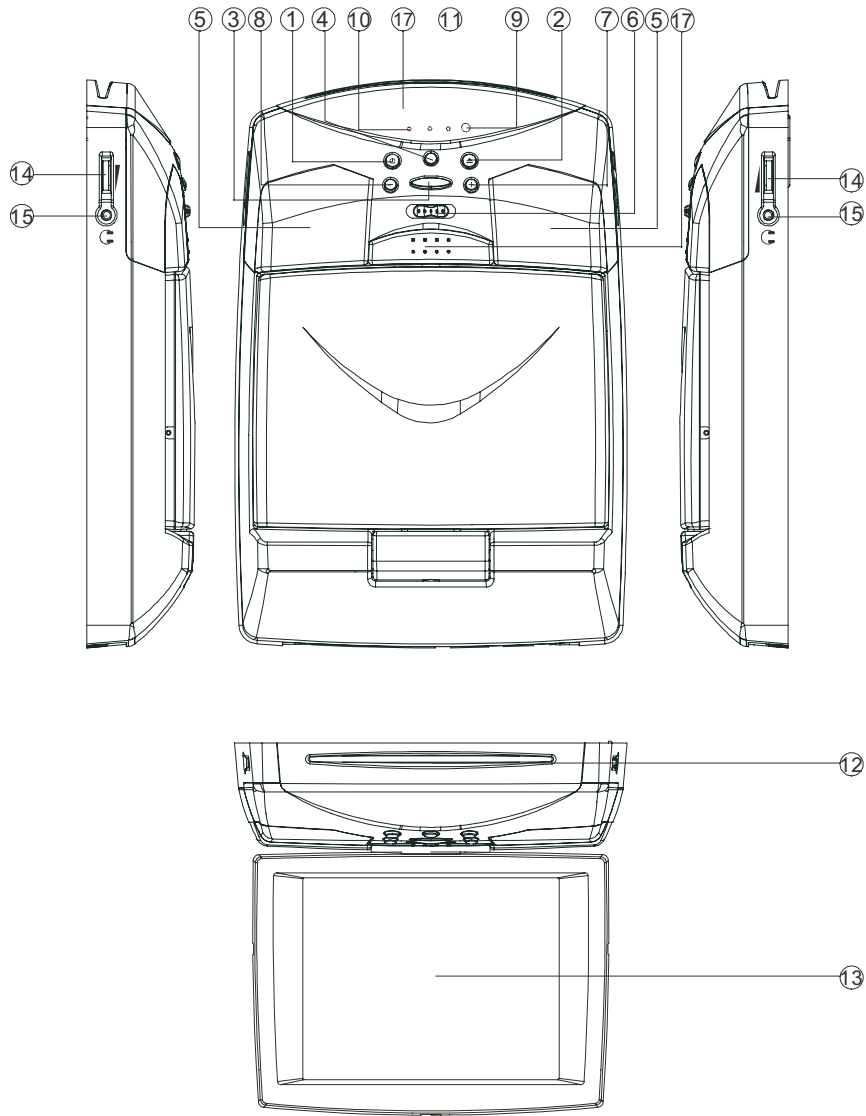

Video System Controls and Description

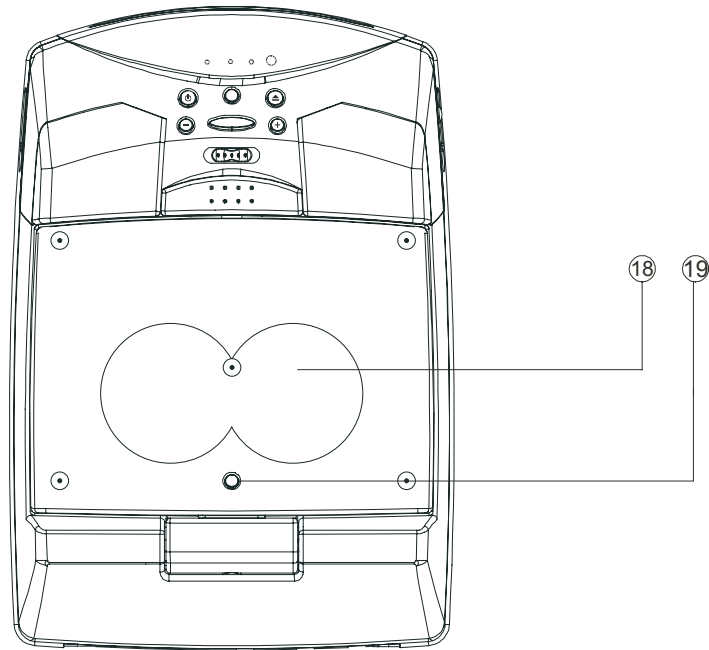



- | | |
|---|--|
| 1. POWER Button  | 11. Indicator Light for AV |
| 2. EJECT Button  | 12. Disc Slot |
| 3. MENU Button | 13. 6.4 inch TFT Color Monitor |
| 4. MOD Button | 14. Earphone Volume Controls |
| 5. Car Dome Lamps | 15. Jacks for Earphone |
| 6. Light Switch | 16. IR Transmitting Window |
| 7. VOLUME+ | 17. OPEN Button: Press the button to
deploy the screen display from the
unit's base. |
| 8. VOLUME- | |
| 9. IR Receiver | |
| 10. Indicator Light for DVD | 18. Speakers (qty-2) |
| | 19. Speaker On/Off button |

NOTE: The TRANSMIT feature must be Off on the Setup Menu for the speakers to operate. The auxiliary audio output and conventional headphone jacks are active at all times.

Remote Control

FUNCTIONS

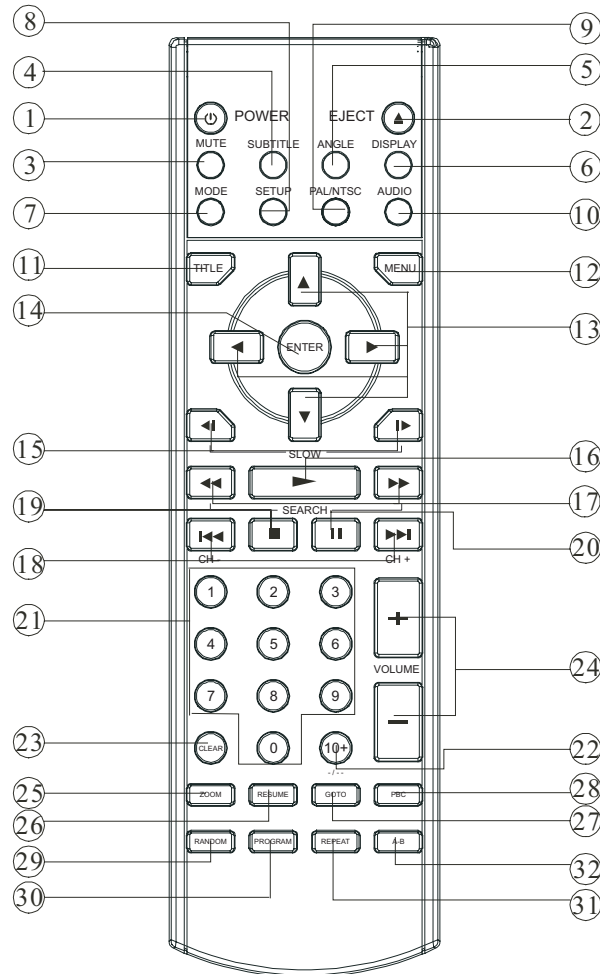

1. POWER Press to turn the unit ON or OFF.
2. EJECT Press to eject the disc.
3. MUTE Press to mute the sound.
4. SUBTITLE Changing of the SUBTITLE language on multi-subtitle language DVD disc.

- | | |
|---------------------------|--|
| 5. ANGLE | Changing of the view angle on multi-angle DVD disc. |
| 6. DISPLAY | Display statistical disc information during playback. |
| 7. MODE | Changing between DVD mode, TV mode and AV mode. |
| 8. SETUP | Display the SETUP menu. |
| 9. PAL/NTSC | Switch between PAL mode and NTSC mode. |
| 10. AUDIO | Changing of the AUDIO soundtrack on multi-audio sound-track DVD disc, or changing of the sound mode of the VCD/CD discs. |
| 11. TITLE | Display the TITLE menu that is stored in DVD disc. |
| 12. MENU | Display the adjustment items, such as Bright, Contrast, Color, Tint, Transmit, Screen, Search and etc. |
| 13. ◀/▶/▲/▼ | In case of SETUP Menu mode, the left/right/up/down ◀/▶/▲/▼ buttons served as cursor buttons to select item left/right, ahead/back. |
| 14. ENTER | Confirm the Track/Chapter selected with the numeric buttons or selected with the cursor buttons on TV screen. |
| 15. ▶/◀ | Change the slow forward/reverse playback motion. |
| 16. ▶ | Press to play the disc. |
| 17. ◀◀ / ▶▶ | Press ▶▶ to search forward rapidly and ◀◀ to search reverse rapidly. |
| 18. ▶▶ (CH+)/
◀◀ (CH-) | Press ▶▶ to skip to the next track & press ◀◀ to skip back one track. |
| 19. ■ | Press ■ to stop playback. |
| 20. | Press to pause playback. |
| 21. 0-9 | Numeric buttons |
| 22. 10+(-/--) | Digital selection button, used with numeric buttons. |
| 23. CLEAR | Press this button to clear an erroneous numeric entry. |
| 24. VOLUME +/- | Press VOLUME +/- button to increase or decrease volume level. |

Adjust the following items when MENU has been selected.

- | | |
|----------|---|
| 25. ZOOM | Allows the picture to be increased in size. |
|----------|---|

- | | |
|-------------|---|
| 26. RESUME | When in stop mode, press the button, the play can be resumed from the stop point. |
| 27. GOTO | Disc search button, used with numeric buttons. |
| 28. PBC | Changing between PBC ON and PBC OFF on the VCD disc. |
| 29. RANDOM | Allows the track played in random order. |
| 30. PROGRAM | Allows the track played in the order you programmed. |
| 31. REPEAT | Switch the Repeat mode of discs. |
| 32. A-B | A-B repeat allows a passage to be repeated continuously. |

BATTERY REPLACEMENT

Use the following procedure to inserting/replacing the batteries

1. Open the battery compartment cover.
2. Remove the old batteries and insert the new batteries (two AAA size). Make sure that the positive and negative terminals of the batteries are oriented as indicated.
3. Close the cover.

USING THE REMOTE CONTROL

Point the remote control towards the player front face IR mark (remote control signal receiver).

Operation angle: The remote will function in about up to a ± 30 degree angle from the front of the IR receiver.

Operation

LOADING/EJECTING A DISC

When you have installed the unit and all connections have completed, you can load a disc as follows:

1. Turn the ignition on to the accessory position.
2. Press the POWER button (item 1 on the figure below).
3. Insert the disc with printed side facing up into the disc slot (item 2 on the figure below).
4. The player will start playback automatically.

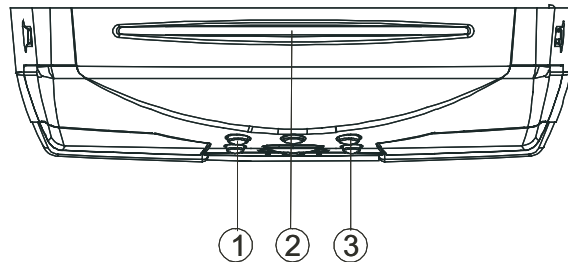

To eject a disc, press the EJECT ▲ button (item 3 on the figure above).

STOPPING PLAY

Briefly press the ■ STOP button to stop the unit playback, when the ► PLAY button is pressed, normal playback will continue.

Press ■ STOP button twice to stop the playback and go back to the initial Track/Chapter on the disc.

RAPID FORWARD/REVERSE

Press ◀◀ or ▶▶ during play.

Each time the button is pressed, the speed of rapid forward /reverse changes according to the disc as follow:

DVD:

Normal playback 2X 4X 6X 8X

VCD/CD:

Normal playback 1X 2X 3X 4X

MP3:

Normal playback 2X 4X 6X 8X

On the next press of the button after reaching the maximum speed, the disc resumes normal playback speed.

SKIPPING TRACK

Press the ►► or ◀◀ buttons on the remote control during playback. Press ►► to skip to next track, and ◀◀ to skip back one track.

NOTE: For some VCD2.0 discs (PBC-playback control), the ►► / ◀◀ buttons may be unavailable.

SLOW MOTION PLAY

Press ►| or ◀| during playback of a DVD. Each time the button is pressed, the speed of slow forward /reverse changes according to the disc as follows:

DVD:

Normal Playback 2X 4X 8X

On the next press of the button after reaching the minimum speed, the disc resumes normal playback speed.

PAUSE

Pressing || on the remote control during playback will stop play temporary. Press ► PLAY on the remote control to resume normal playback.

MUTE

Will mute the audio, but the disc continues playing. When you unmute the audio (press MUTE again), audio will resume.

REPEAT

FOR DVD:

Press the REPEAT button to cycle through the select repeat mode as follows:

CHAPTER REPEAT ON—TITLE REPEAT ON—REPEAT OFF

FOR VCD/CD:

Press the REPEAT button to cycle through the select repeat mode as follows.

REP-ONE—REP-ALL—REPEAT OFF

1. REP ONE—Continuously repeat at the current chapter/track.
2. REP-ALL—Continuously repeat all chapter/track on the current disc.
3. When the player finishes playback of the current disc last chapter/track, it will stop and display the elapsed time. When REPEAT OFF mode is selected, REP-ONE & REP-ALL disappears from screen display.
4. REPEAT feature does not support VCD2.0 (with PBC ON).

A-B

A-B repeat allows a passage to be repeated continuously. Press A-B button at the start of the required passage, then press A-B button again at the end of the passage. To revert to normal playing, press A-B button again. Each time the button is pressed, the screen will display as follows:

A TO B SET A A TO B SET B A TO B CANCELLED

DISC SEARCH (GOTO)

FOR DVD:

Press GOTO button twice, the screen will display the following message:

TITLE 01/01 TIME -- : -- : -- 00:00:25

You can select the item you want to watch through the TIME setting by using numeric buttons and then the ENTER key.

FOR CD/VCD (WITH PBC OFF):

Press GOTO button once, the screen will display the following message:

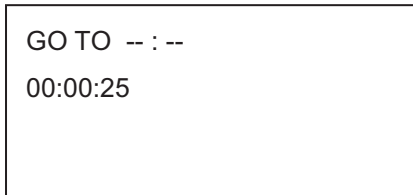

Use numeric buttons to input the time directly.

ZOOM

Allows the picture to be increased in size. Press ZOOM to toggle among 1.5 scale, 2.0 scale and 3.0 scale.

RANDOM

Press RANDOM button, track selection will be made in random order. The display screen will show "SHUFFLE ON" on the screen. Press RANDOM button again, "SHUFFLE OFF" appears and the mode is released.

PROGRAM

In stop mode, press PROGRAM button, the screen will display "PROGRAM P00:00". For example: press numeric button 4 and ► PLAY button, "PROGRAM P01:04" appears. It means track 4 will be played first.

MODE SELECTION

Press MOD button on the front panel of the unit or MODE button on the remote control to select among DVD, or AV mode. When the mode is selected, the corresponding mode indicator on the front panel will be illuminated.

VOLUME LEVEL ADJUSTMENT

Press VOL +/VOL- on the front panel or VOLUME +/- on the remote control to increase or decrease the volume level.

LIGHT SWITCH

The two car dome lamps on the unit will be illuminated depending on the lamp operation setting. There are three settings for the car dome lamp operation: OFF, AUTO, and ON.

- A. OFF: To turn off the lamp.
- B. AUTO: To make the lamp turn on only when car doors are opened.
- C. ON: To turn on the lamp.

JACK FOR EARPHONE

There are two jacks for earphones, one on each side of the DVD unit. You can connect an earphone to anyone of the jacks to receive audio.

EARPHONE VOLUME ADJUSTMENT

Slide the control on the side of the DVD unit to increase or decrease the volume level of the earphone.

REMOTE SENSOR (IR)

This IR sensor receives it's signal from the remote control.

TURNING THE UNIT ON/OFF

Press the  POWER button on the front panel or on the remote control to turn the unit on or off.

MONITOR RELEASE

Press the button on the unit to deploy the screen display from the base of the uni.. Then the display can easily be adjusted for the best viewing.

INFRARED TRANSMITTING WINDOW

There are six infrared transmitting lights inside the window on the unit, the user can put on the infrared wireless headphones supplied with the unit and hear the audio signal without the use of wires or cables from the unit to the headphones.

LCD Menu Operations

MENU

Press the MENU button on the unit or on the remote control during DVD or AV mode to display a menu of the adjustment items on the screen.

MENU	
BRIGHT	20
CONTRAST	25
COLOR	45
TINT	10
TRANSMIT	ON
SCREEN	16:9
SEARCH...	
-----■-----	

Press MENU button repeatedly to select among BRIGHT, CONTRAST, COLOR and TINT (For the unit with NTSC system) items and etc. Press VOL +/- buttons on the unit or VOLUME +/- buttons on the remote control to adjust the corresponding item.

Note: When you set the TV TYPE item to "PAL" in "PREFERENCES SETUP", there is no "TINT" item to display.

TRANSMIT

The TRANSMIT item, can be set ON or OFF. When set it to ON, the sound signal is transmitted from the infrared window on the unit for use with infrared wireless headphones.

SCREEN

In SCREEN item, you can select appropriate TV aspect ratio (4:3 or 16:9) using the VOL +/VOL- buttons on the unit or VOLUME +/- buttons on the remote control.

SEARCH

This menu selection is not used with this model.

On Screen Displays

DISPLAY

Press the DISPLAY button during playback to display the contents of the current disc on the screen. The following examples depict the display by disc type.

DVD

(1) Press DISPLAY for the first time:

TITLE 01/03 CHAPTER 002/025
00:02:25

The present title number, total number of titles, the present chapter number, the total number of chapters of the disc currently being played will be shown on the screen, along with the elapsed time.

(2) Press DISPLAY a second time:

TITLE REMAIN
01:46:58

The remaining playing time for the title presently playing is displayed.

(3) Press DISPLAY a third time:

CHAPTER ELAPSED
00:00:24

The elapsed playing time for the chapter presently playing is displayed.

(4) Press DISPLAY a fourth time:

CHAPTER REMAIN
00:01:39

The remaining playing time for the chapter presently playing is displayed.

(5) Press DISPLAY a fifth time:

The message is cleared off the screen.

VCD

(1) Press DISPLAY for the first time:

SINGLE ELAPSED
00:00:25

The remaining playing time for the single presently playing is displayed.

(2) Press DISPLAY a second time:

SINGLE REMAIN
00:03:15

The remaining time for the single presently playing is displayed.

(3) Press DISPLAY a third time:

TOTAL ELAPSED
00:00:25

The elapsed playing time for the disc presently playing is displayed.

(4) Press DISPLAY a fourth time:

TOTAL REMAIN
00:40:35

The remaining playing time for the disc presently playing is displayed.

(5) Press DISPLAY a fifth time:

The message is cleared off the screen.

CD

(1) Press DISPLAY for the first time:

SINGLE ELAPSED
00:00:25

TRACK: 01/14

The elapsed playing time for the track presently playing is displayed.

(2) Press DISPLAY a second time:

SINGLE REMAIN 00:03:15 TRACK: 01/14

The remaining time for the track presently playing is displayed.

(3) Press DISPLAY a third time:

TOTAL ELAPSED 00:00:25 TRACK: 01/14

The elapsed playing time for the disc presently playing is displayed.

(4) Press DISPLAY a fourth time:

TOTAL REMAIN 00:40:35 TRACK: 01/14
--

The remaining playing time for the disc presently playing is displayed.

(5) Press DISPLAY a fifth time:

The message is cleared off the screen.

MP3

The following applies when the system is set for NO MENU in SMARTNAV, this feature is discussed later in this guide.

(1) Press DISPLAY for the first time:

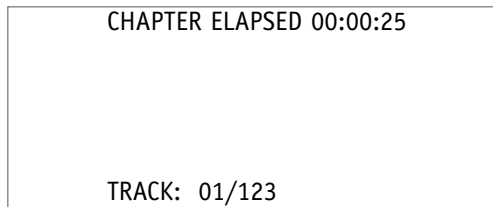

The elapsed playing time for the chapter presently playing is displayed.

(2) Press DISPLAY a second time:

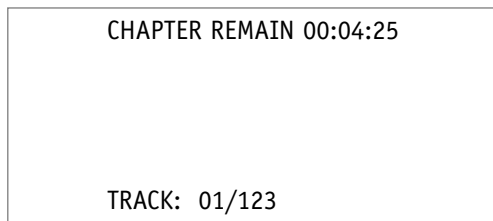

The remaining time for the chapter presently playing is displayed.

(3) Press DISPLAY a third time:

The message is cleared off the screen.

MULTI-AUDIO LANGUAGE FUNCTION

DVD

Press the AUDIO button on the remote control during playback. Each time the button is pressed, the audio soundtrack language changes in sequential order.

Note:

- The number of languages on a disc varies according to the disc.
- Some discs only contain one language soundtrack.
- When no different language soundtrack are recorded, the  will be displayed at the screen's left top corner.

VCD/CD

Press AUDIO on the remote control during playback. It is possible to switch the sound between monaural (left/right) and stereo sound, as given below.

MONO LEFT MONO RIGHT STEREO

TITLE MENU FUNCTION

This function applies only to DVDs. If the DVD has multiple titles recorded on the disc. It can select preferred title from the title menu to start playback.

1. Press the TITLE button during playback. The title menu is display.
2. Press the cursor button shown in screen display, select preferred title by the cursor button and by pressing the ENTER button.

MULTI-SUBTITLE LANGUAGE FUNCTION

This function applies only to DVDs. Press the SUBTITLE button during playback. Each time the button is pressed, the subtitle language changes in sequential order.

Note:

- The number of languages on a disc varies according to the disc.
- Some discs only contain one language soundtrack.
- When no different language soundtrack are recorded, the  will be displayed at the screen's left top corner.

MULTI-ANGLE FUNCTION

This function applies only to DVDs. Press the ANGLE button during playback. Each time the button is pressed, the viewing angle changes in sequential order.

Note:

- The angle number is different according to the disc.
- The function only works for discs having scenes recorded at different angles.
- When no different angle is recorded, the  will be displayed at the screen's left top corner.

MP3 DISC PLAY

When a MP3 disc is playing an example of the format of the FOLDER is as follows:

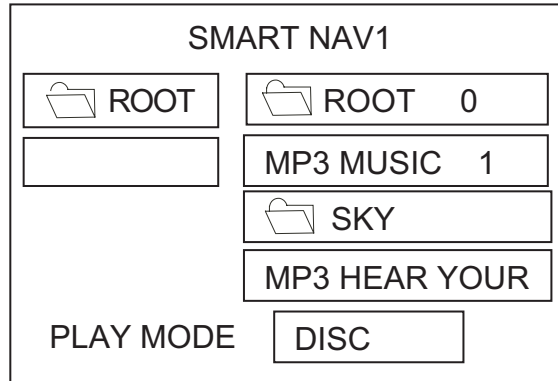

Use the ◀/▶/▲/▼ buttons on the remote control to select the item or folder, then press the ENTER button.

Each press of the REPEAT button selects one of three repeat play modes, these are:

REP-ONE: Repeats play of the same song.

FOLDER REP: Repeats play of all songs in the current directory in sequence.

FOLDER: Plays all the songs in the current directory once.

When PLAY MODE is selected, press the ▲/▼ buttons to change between the following modes:

SINGLE, REP-ONE, FOLDER, FOLDER REP, DISC SCAN, DISC, DISC REP, SHUFFLE ON, PROGRAM PXXX

During the playback, use the ▲/▼ buttons to skip an item ahead or back.

◀◀ Rapid reverse, ▶▶ Rapid advance.

Note: The FOLDER cannot be selected during playback. It can be selected after the ■ Stop button has been pressed.

TV OPERATION

This function is not available on this system.

Setup

INITIAL SETUP

1. Press SETUP in the stop mode. (Press the stop button twice to ensure that the player is in STOP mode.) The initial SETUP menu is displayed.

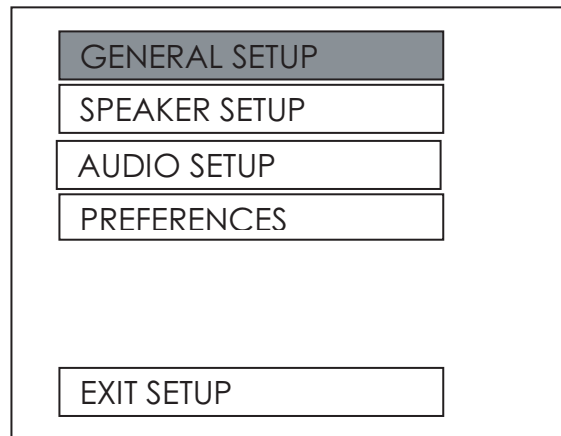

2. Select the preferred item by using the ▲/▼ buttons.
3. Press ENTER button.

GENERAL SETUP

This setup page includes all the items of TV (LCD) display & Audio output features. For details refer to GENERAL SETUP MENU.

SPEAKER SETUP

This is to activate the audio output from DOLBY AC3 5.1 DOWNMIX to 2 channel mode. For details refer to SPEAKER SETUP MENU.

AUDIO SETUP

This setup page includes all the items for AUDIO. For details refer to AUDIO SETUP MENU.

PREFERENCES SETUP

This setup page includes the configuration of support features. For details refer to PREFERENCES SETUP MENU.

GENERAL SETUP

TV DISPLAY SETUP

TV DISPLAY	NORMAL/P
PIC MODE	NORMAL/L
ANGLE MARK	WIDE
OSD LANG	
CAPTIONS	
SCR SAVER	
MAIN PAGE	

This is to select the appropriate TV (LCD) aspect ratio (4:3 or 16:9).

Video Material	TV Screen			
	4:3			Wide (16:9)
	Normal	Pan Scan	Letter-box	
4:3				
16:9				

NORMAL/PS (FOR 4:3 TV)

Played back in the PAN & SCAN style. (the left and right edges of the image are cut off.)

NORMAL/LB (FOR 4:3 TV)

Played back in letterbox style. (black bands appear at top and bottom of the screen.)

WIDE (FOR 16:9 TV)

Select when a wide-screen format.

PIC MODE SETUP

TV DISPLAY	
PIC MODE	AUTO
ANGLE MARK	HI-RES
OSD LANG	N-FLICKER
CAPTIONS	
SCR SAVER	
MAIN PAGE	

Select the AUTO button, the player PIC mode will depend on the formatting of DVD disc.

Select HI-RES format for best image resolution.

Select N-FLICKER format on image or picture with noise and distortion.

ANGLE MARK

TV DISPLAY	
PIC MODE	ON
ANGLE MARK	OFF
OSD LANG	
CAPTIONS	
SCR SAVER	
MAIN PAGE	

If it is set to ON, when the multi-angle recorded DVD disc is playing, the  (the angle icon) will appear on the screen; if it is set to "OFF", the mark will not appear.

OSD LANG

TV DISPLAY	
PIC MODE	
ANGLE MARK	
OSD LANG	ENGLISH
CAPTIONS	FRENCH
SCR SAVER	GERMAN
	ITALIAN
	SPANISH
MAIN PAGE	

Select the preferred OSD (On Screen Display) language by using the ▲/▼ buttons.

CAPTIONS

TV DISPLAY	
PIC MODE	
ANGLE MARK	
OSD LANG	
CAPTIONS	OFF
SCR SAVER	ON
MAIN PAGE	

Activate the CAPTIONS feature by selecting ON. And deactivate this feature by selecting OFF.

SCR SAVER

TY DISPLAY	
PIC MODE	
ANGLE	
OSD LANG	
CAPTIONS	
SCR SAVER	ON
	OFF
MAIN PAGE	

Select the SCR SAVER ON/OFF.

SPEAKER SETUP

DOWNMIX	LT/RT
	STEREO
MAIN PAGE	

This is to activate the audio output from DOLBY AC3 5.1 DOWNMIX to 2 channel mode.

Select the preferred SPEAKER connection by using the cursor buttons.

- Select the LT/RT to activate the Dolby surround-sound compatible output.
- Select the STEREO to activate stereo mode.

AUDIO SETUP

AUDIO OUT

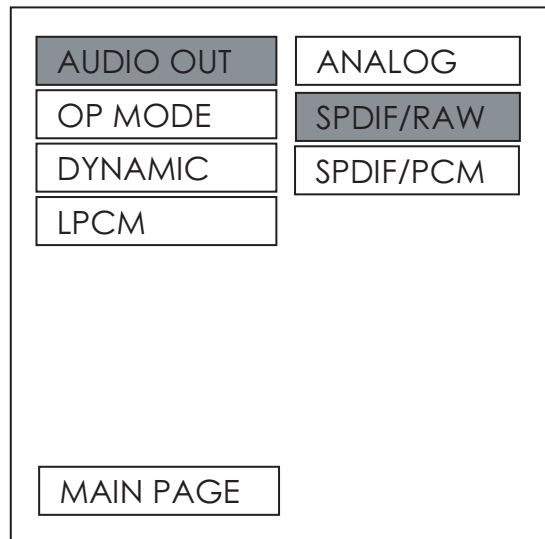

This feature is not applicable for this model.

OP MODE

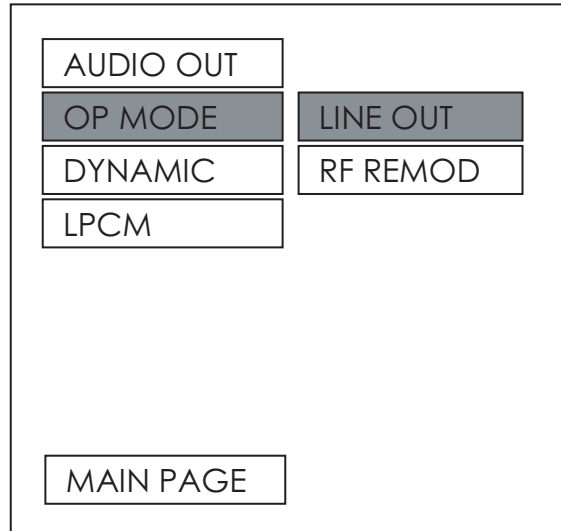

There are two operating modes for the Dolby Digital decoder: LINE OUT and RF REMOD.

DYNAMIC RANGE CONTROL

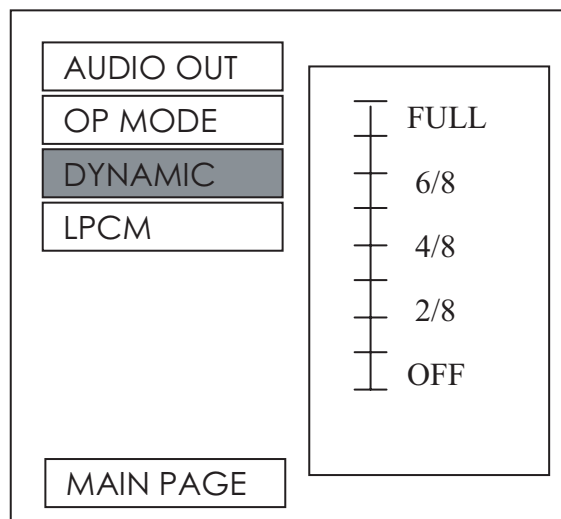

Select DYNAMIC and adjust the dynamic range of a Dolby Digital encoded program. There are 8 steps between full compression and off compression.

LPCM OUTPUT

AUDIO OUT	
OP MODE	
DYNAMIC	
LPCM	LPCM 48K
	LPCM 96K
MAIN PAGE	

Select the LPCM OUTPUT between LPCM48K and LPCM 96K.

PREFERENCES SETUP (INCLUDING PARENTAL)

TV TYPE SETUP

TV TYPE	AUTO
AUDIO	NTSC
SUBTITLE	PAL
DISC MENU	
PARENTAL	
PASSWORD	
DEFAULTS	
SMART NAV	
LOGO	
MAIN PAGE	

This system can play discs recorded in either PAL or NTSC format.

Select NTSC format, when the unit is connected to NTSC TV.

Select PAL format, when the unit is connected to PAL TV.

Select AUTO format, the player TV output format will be according to the DVD disc format.

AUDIO (LANGUAGE)

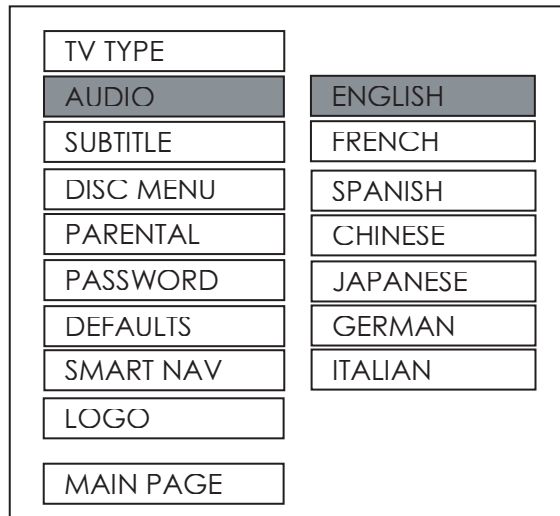

Select the preferred AUDIO language soundtrack by using the cursor buttons.

SUBTITLE (LANGUAGE)

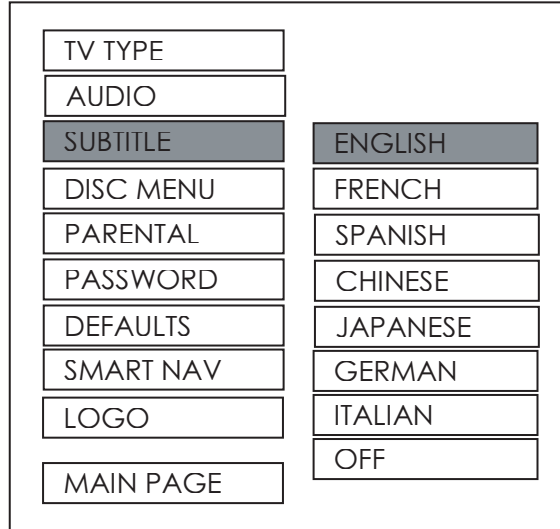

Select the preferred SUBTITLE language by using the cursor buttons.

DISC MENU (LANGUAGE)

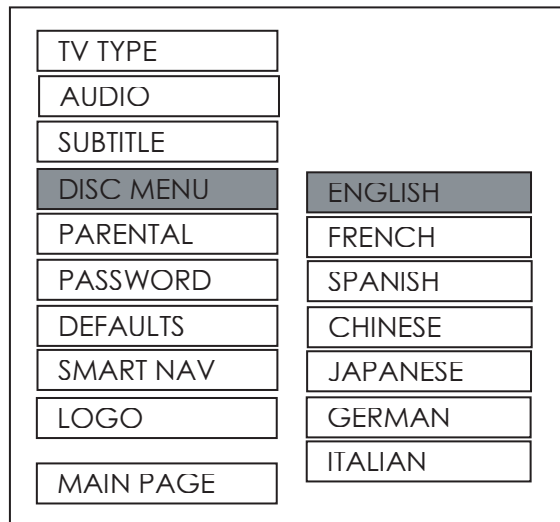

Select the preferred DISC MENU language by using the cursor buttons.

PARENTAL

TV TYPE	1 G
AUDIO	2
SUBTITLE	3 PG
DISC MENU	4 PG 13
PARENTAL	5
PASSWORD	6 PG-R
DEFAULTS	7 NC-17
SMART NAV	8 ADULT
LOGO	NO PARENTAL
MAIN PAGE	

Select suitable parental guidance by the cursor buttons and confirm by pressing ENTER button. When the Parental level is changed, the password (described below) is required.

PASSWORD

TV TYPE	
AUDIO	
SUBTITLE	
DISC MENU	
PARENTAL	
PASSWORD	CHANGE
DEFAULTS	
SMART NAV	
LOGO	
MAIN PAGE	

Select CHANGE and press ENTER button. Type the old password (The initial factory code is 3308) and key in 4 characters password now you want to use, and retype again to confirm key in correctly. Ensure that you write down and keep the new password in a secure location.

DEFAULTS

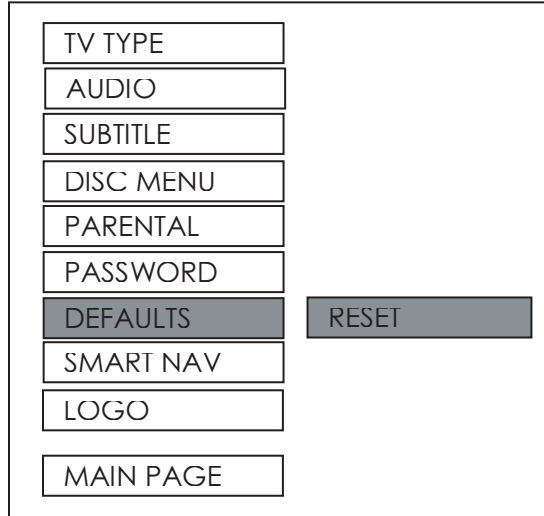

Select reset to revert to factory initial settings (except for password).

SMART NAV

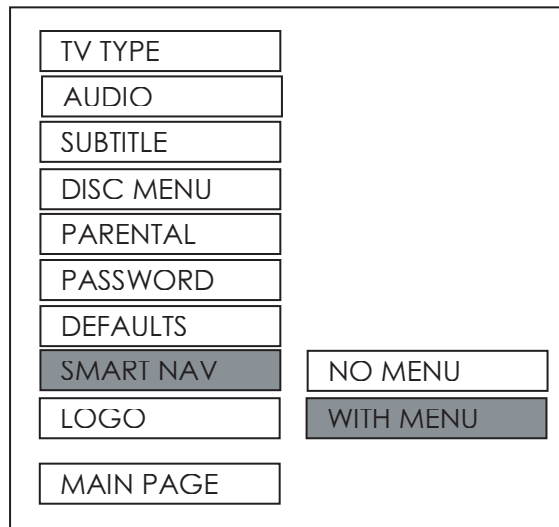

This feature allows you to select NO MENU mode or WITH MENU mode.

LOGO

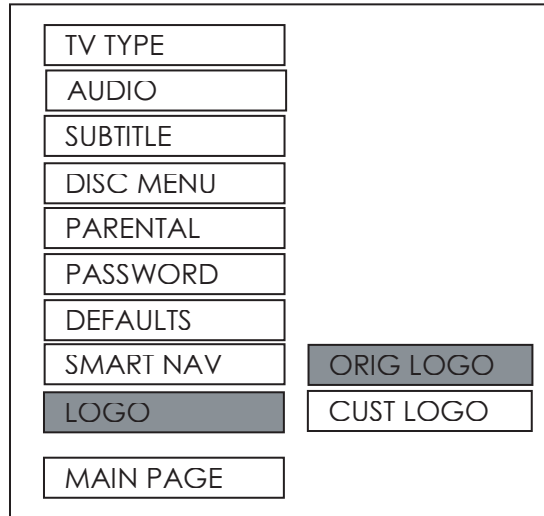

The LOGO feature is inactive.

FACTORY DEFAULT SETTING

The following table lists the factory default settings for each setup feature.

Menu Screen	Sub-Menu	Default Setting
General Setup	TV Display	Normal/LB
	PIC mode	AUTO
	Angle mark	ON
	OSD Language	English
	Captions	ON
	SCR Saver	ON
Speaker Setup	Downmix	Stereo
Audio Setup	Audio Out	SPDIF/RAW
	OP Mode	Line Out
	Dynamic	FULL
	LPCM Output	LPCM 96K
Preferences	TV Type	AUTO
	Audio	English
	Subtitle	English
	Disc Menu	English
	Parental	NO Parental
	Password	3308
	SmartNav	With Menu
	Logo	Orig Logo

Appendix A – Cleaning

CLEANING THE LCD SCREEN

CAUTION: To avoid possible shock hazard and equipment damage, be sure the LCD system is turned off and unplugged from the main electrical outlet before cleaning.

CAUTION: Do not use any form of solvents on the LCD screen or enclosure.

1. Use a soft, clean & dry cloth to gently wipe off the dust on the LCD screen.
2. Use a clean cloth dampened with water to wipe off the dirt.
3. Do not exert excessive force when cleaning the LCD screen.

CLEANING THE ENCLOSURE

1. Use a soft, clean & dry cloth to gently wipe off the dust on the enclosure.
2. Use a clean cloth dampened with water to wipe off the dirt.
3. Do not exert excessive force when cleaning the enclosure.

CLEANING AND HANDLING DISCS

HANDLING

- Dirt, dust, scratches and warping discs will cause misoperation.
- Do not place stickers or make scratches on discs.
- Do not warp discs.
- A disc should always be kept in its case when not in use to prevent from damaging.

Do not place discs in the following places:

1. Direct sunlight.
2. Dirty, dusty and damp areas.
3. Near car heaters.
4. On the seats or dashboard.

DISC CLEANING

Use a dry soft cloth to wipe the surface. If the disc is quite dirty, use a soft cloth slightly moistured with isopropyl (rubbing) alcohol. Never use solvents such as benzine, thinner or conventional record cleaners as they may mar the surface of the disc.

Note: A disc may become somewhat scratched (although not enough to make it unusable) depending on you handle it and conditions in the usage environment. These scratches are not an indication of any problem with the player.

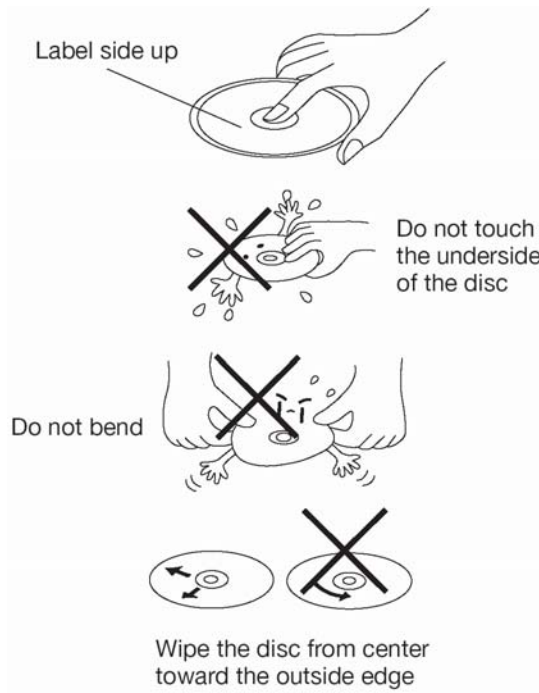

Appendix B – Troubleshooting

If the unit fails to operate normally, try solving the problems using the procedures below. If the problem persists, switch off the unit and ask the dealer or technical services for assistance. Do not attempt to repair or open the defective unit as high voltage is present inside the unit.

1. No Power
 - a. Check to ensure that the On/Off button on the front of the unit is On.
 - b. Check power wiring to the unit.
2. No Picture
 - a. Check that all cables are connected and the LED is illuminated on the control panel above the LCD screen.
 - b. Be sure you have selected the correct source mode (AV, DVD).
3. Distorted Picture
 - a. Check disc for contamination and clean with soft cloth, wiping from center to edge.
 - b. Sometimes a small amount of picture distortion may appear, this is not a malfunction of the player.
4. Severely Distorted Picture or No Color in Picture
 - a. The disc format is not compatible with the player (PAL/NTSC).
5. DVD Player Not Working Properly
 - a. Ensure disc is correctly inserted into the unit.
 - b. Inspect the disc is not damaged (no scratches on the recorded side of the disc) and is of correct format to play in the unit.
 - c. Please wait as some disc requires longer time to read-in prior to playing.
 - d. Eject and re-insert disc.
6. Picture flickers
 - a. Check that the power coming from the main socket is sufficient.
 - b. Check that unit is not placed too near speakers or magnetic objects.
 - c. Check to see that the unit settings are correct.
7. Start-Up Screen doesn't display when disc is removed
 - a. Press the Power button to turn the unit off, then press it again to turn the power back on.
8. No sound
 - a. Check audio connections.
 - b. Volume set too low, increase the volume setting.
9. No audio at digital output

- a. Check digital connections.
 - b. Check the Digital Audio menu setup to ensure that the digital output is correctly set.
 - c. Check if the audio format of the selected audio language matches your systems capabilities.
10. Remote control not working.
- a. Check to verify that the batteries are installed correctly (polarities aligned with case markings), replace if necessary (2-AAAs).
 - b. Make sure that the remote control is pointed towards the remote sensor located on the system.
11. Buttons do not work.
- a. Turn the unit off and then back on with the power On/Off button at the front of the unit.

Appendix C – Specifications

Signal System	Composite video 1.0Vp-p @ 75 ohms
Discs compatability	DVD video disc 5" (12cm) single-sided, single-layer 5" (12cm) single-sided, double-layer CD-DA/CD-R/CD-RW/MP3 compact disc Video CD 5" (12cm)
Audio output	10Kohms (2ch 2.0 Vrms) 20Hz—20kHz 80 dB (JIS) S/N ratio Wow & Flutter—below measurable limits
Wireless audio	Infrared audio transmitter (support IR receiver stereo headphone, L-channel 2.3 MHz/R-channel 2.8 MHz) Effective listening angle: 30° Effective range: 4 meters
Operating voltage	9–16 VDC
Operating current	Less than 2A

NOTE: All specifications are subject to change without notice.

The company behind this system is Directed Electronics, Inc.

Since its inception, Directed has had one purpose, to provide consumers with the finest vehicle security, car stereo products, rear seat entertainment, and accessories available. The recipient of more than 20 patents in the field of advanced electronic technology, Directed is ISO 9001 registered.

Quality Directed Electronics products are sold and serviced throughout North America and around the world.

Call **(800) 274-0200** for more information about our products and services.



DEI is an ISO 9001 registered company.

Directed* is committed to delivering world-class quality products and services that excite and delight our customers.



Directed Electronics, Inc.
Vista, CA 92081
www.directed.com

© 2004 Directed Electronics, Inc.—All rights reserved
N83070A 12-04

Free Manuals Download Website

<http://myh66.com>

<http://usermanuals.us>

<http://www.somanuals.com>

<http://www.4manuals.cc>

<http://www.manual-lib.com>

<http://www.404manual.com>

<http://www.luxmanual.com>

<http://aubethermostatmanual.com>

Golf course search by state

<http://golfingnear.com>

Email search by domain

<http://emailbydomain.com>

Auto manuals search

<http://auto.somanuals.com>

TV manuals search

<http://tv.somanuals.com>