

Directed
VIDEO

OHD 800B
OWNER'S MANUAL



8.5" TFT-LCD DVD/SD/USB COMBO MONITOR

Contents

Caution	4	Password mode.....	23
System overview	6	Password change.....	23
Remote control	8	DVD Functions	24
Power and Mode selection	10	Eject.....	24
Releasing the monitor.....	10	Vol.....	24
How to watch the monitor.....	10	Mute.....	24
Mute function.....	10	Play or Pause.....	24
AVC (DVD/AV1/AV2) Mode.....	11	Audio.....	24
Picture Control	12	Stop.....	25
Contrast/brightness/color/FM.....	12	Arrows.....	25
DVD Setup	13	Setup.....	25
Setup Menu	13	Menu.....	25
General Setup	14	Display.....	26
TV Display.....	14	Number buttons.....	26
Angle mark.....	14	Subtitle.....	27
OSD lang.....	14	Title.....	27
Captions.....	15	Slow.....	27
Screen saver.....	15	Fast reverse.....	28
Last memory.....	15	Fast forward.....	28
Audio Setup	15	Prev.....	29
Dolby Digital Setup.....	16	Next.....	29
Equalizer.....	16	Repeat A-B.....	29
Video Setup	18	Repeat.....	30
Quality.....	18	NTSC/PAL.....	30
Preference	21	Angle.....	30
TV type.....	21	PBC.....	31
PBC.....	21	Zoom.....	31
Audio.....	21	Goto.....	31
Subtitle.....	21	Connect diagram	32
Disc menu.....	22	Installation	33
Parental.....	22	Disc information	34
Country region.....	22	Troubleshooting	35
Default.....	22	Specifications	36
Password setup	23		

Caution

Please read and observe all warnings and instructions in this owner's manual and those marked on the unit. Retain this booklet for future reference.

There are two kinds of alarm symbols as follows:



WARNING

The lightning flash with arrowhead symbol within an equilateral triangle is intended to alert the user to the presence of dangerous voltage within the product's enclosure that may be of sufficient magnitude to constitute a risk of electric shock to people.



CAUTION

The exclamation point within an equilateral triangle is intended to alert the user to the presence of important operating and maintenance (servicing) instructions in the literature accompanying the product.



WARNING



Installation of all TV monitors must be out of the driver's field of sight.



Do not mount the product where it will obstruct the deployment of the airbag or in an area where it would affect the vehicular control. Also be careful to avoid mounting the product where it can become hazardous during sudden stops or in the event of an accident.



Do not try and service these products yourself, seek an authorized dealer or contact Directed Electronics.



Use extra caution with any liquids in your car. If you or your child spills any liquid on this product, pull your vehicle to the roadside and turn the key off to disconnect or wipe the products with a towel. Do not operate the equipment until all liquids have either evaporated or you have had the monitor inspected at a service center by a qualified technician. Severe harm or danger can be occurred.



Be careful not to drop or apply under pressure to the front panel of your video monitor. If the screen cracks due to misuse, your warranty will be void!



Use only a damp cloth to clean the screen and use only purified water on the cloth. Wring out all excess water prior to wiping the screen. Do not use any cleaners or chemicals to clean the screen. In most cases a dry cloth will do!

CAUTION



Quality installations are best performed by qualified and certified installers.



Watching the monitor for an extended period of time without the engine running may deplete the vehicle's battery charge.



This product is designed for operation with a 12 Volt DC, negative ground vehicle. It is not suitable for operation under other conditions or voltages.



Do not cover or block vents. It may be the origin of a fire or receives an electric shock.

Do not put magnetic devices near the monitor..



Check Point

1. The operating temperature of this product is limited to $-20^{\circ}\text{C}\sim+70^{\circ}\text{C}$.
2. From time to time when your vehicle is extremely hot or cold you must allow time for your air conditioner or heater to cool or heat the vehicle and for operating temperatures to return to normal operating ranges. Your monitor will return to its normal functions when these operating ranges are achieved.
3. Your optimum picture quality is achieved when you are directly in front of the monitor (± 30 degrees).
4. Do not open covers and repair yourself. Refer servicing to qualified personnel.
5. DVD Players use an invisible laser beam which can cause hazardous radiation exposure. Be sure to operate the unit correctly as instructed.
6. Do not disconnect car power supply off while a disc is playing. It can cause damage to the DVD Player.

System overview

● Unit

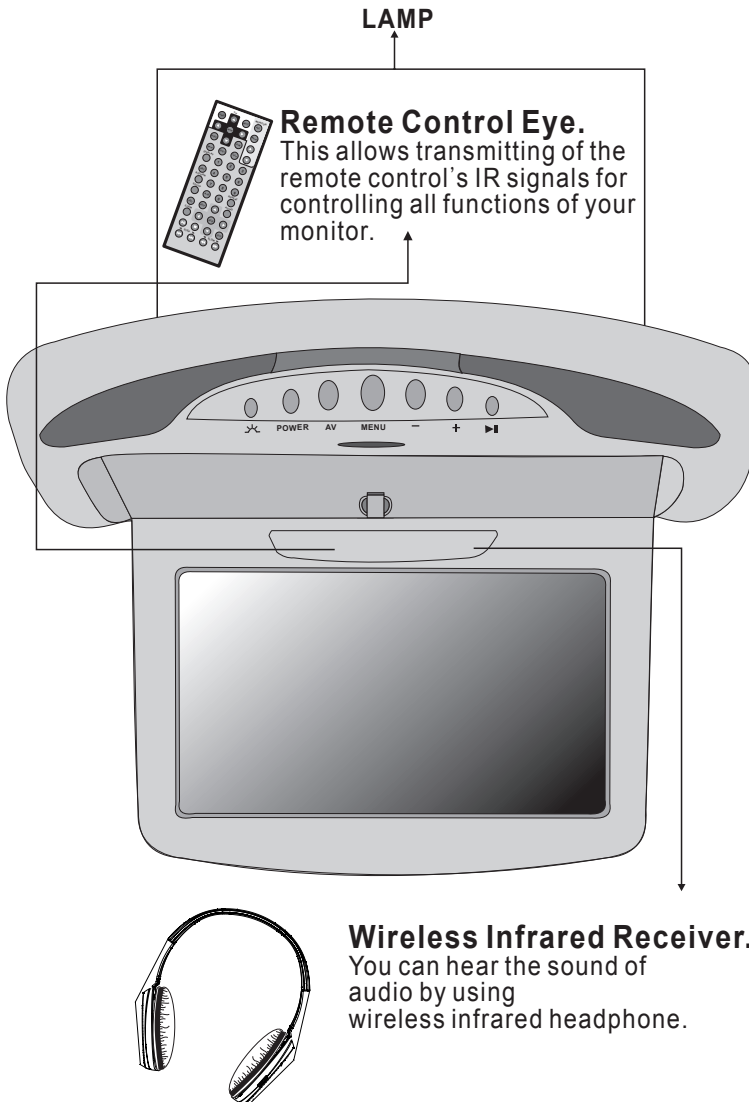

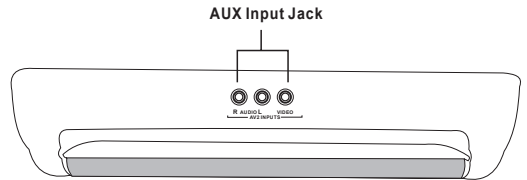
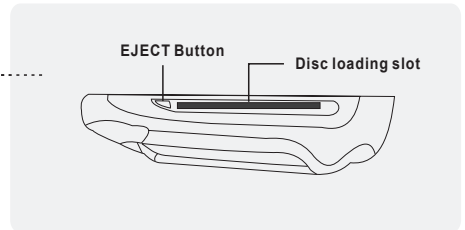
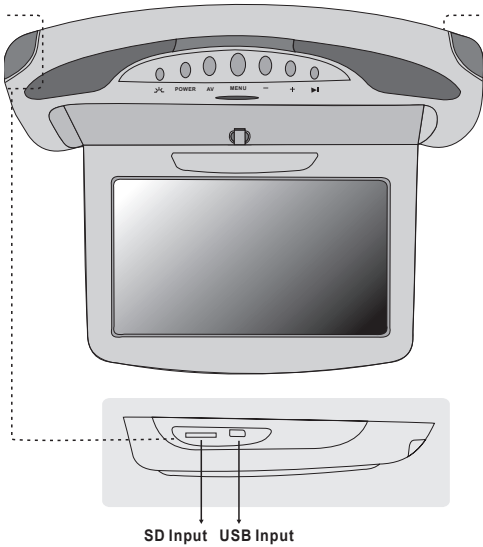
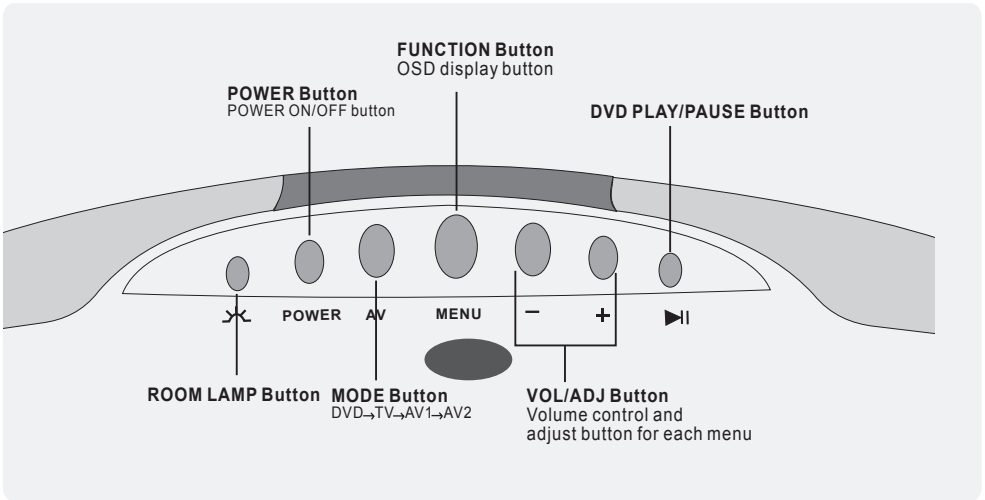

※ Caution

Do not put magnetic devices near the monitor.

Remote Control

- ① **POWER**
Turns the DVD Player & Unit on or off.
- ② **MUTE**
Press this button to switch off the audio during playback. Press again to restore the audio.
- ③ **Auto TV** (Not included)
Automatic search
- ④ **UP/DOWN/RIGHT/LEFT ARROWS TV**
(Not included)
Use to move to the desired menu.
- ⑤ **AVC MONITOR**
DVD- AV4- AV2
- ⑥ **MENU (OSD on monitor) MONITOR**
Press this button to open the on-screen menu system to setup and control various parameters of the monitor and DVD player.
- ⑦ **UP/DOWN MONITOR**
Use to move to the desired menu.
- ⑧ **P/N**
This button permits you to choose among Multi, PAL and NTSC.
- ⑨ **MODE**
DVD- SD- USB
- ⑩ **MENU (DVD menu)**
This button permits you to view the menu on the DVD.
- ⑪ **SUBTITLE**
Use this button to select the menu for choosing a subtitle language.
- ⑫ **TITLE (Title menu)**
When a DVD is playing, press this button to view the Title Menu.
- ⑬ **DISPLAY**
Show information of elapsed or remaining time of a chapter or a title.
- ⑭ **PBC (Video CD only)**
Press this button to access the special Playback Control functions for VCD 2.0 format Video CD's.
- ⑮ **NUMERIC button**
Use when making a selection on the menu screen.

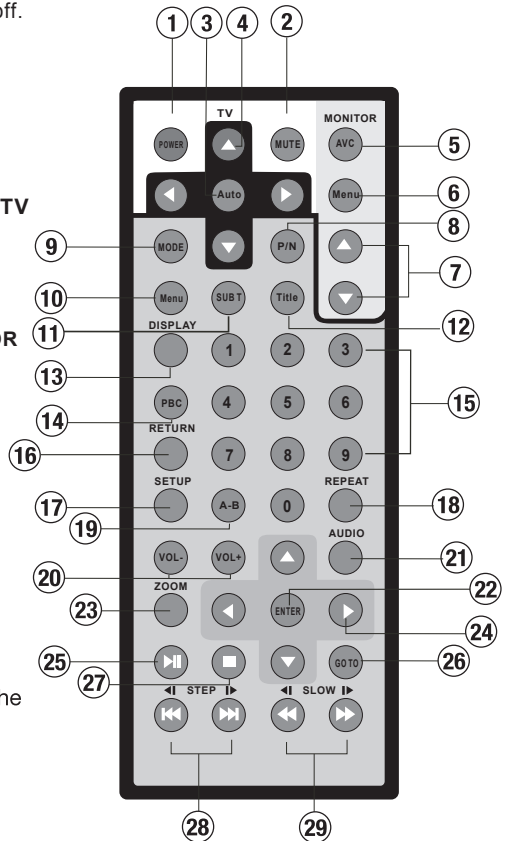

⑮ **RETURN**

⑯ **SETUP**
Press this button to display the Setup menu. The Setup menu enables you to enter the settings required for the unit to work properly.

⑰ **REPEAT**
Press this button to change the playback mode to repeat, and to select the repeat mode.

- 19 A-B (repeat from A to B)**
Use this button to select the beginning and end of a track which you wish to have repeat in playback.
- 20 VOL-/+ button**
Decrease the volume./ Increase the volume.
- 21 AUDIO**
Use this button to select one of the audio soundtracks programmed on a DVD disc. It is also used to select the audio output mode for the DVD playback.
- 22 ENTER**
Press this button to confirm the item you have found and highlighted using the arrow buttons. Usually this is done to confirm a selection or item to be played on the DVD.
- 23 ZOOM**
If your DVD disc supports zooming in to see the program differently, pressing this button will enable you to change the amount of zoom.
- 24 UP/DOWN/RIGHT/LEFT ARROWS**
Use these buttons to navigate the various menus and screens for the monitor and DVD systems.
- 25 PLAY/PAUSE**
To start playback of a disc, press this button. Press again to pause the playback. If playback is paused, press this button to resume playback.
- 26 GOTO**
Use to search a title or a chapter of your DVD disc.
- 27 STOP**
Press this button to stop the playback of the current disc.
- 28 SKIP FORWARD/BACK**
Use these buttons to skip to the next or last track, chapter or file on the disc in the player.
- 29 FAST FORWARD/REVERSE PLAY**
Use these buttons to select either fast forward or fast reverse playback.

Power and Mode selection

● Releasing The Monitor

Push the open button (located on the front of your screen) and lower the monitor to the desired level. You can also adjust the swivel angle

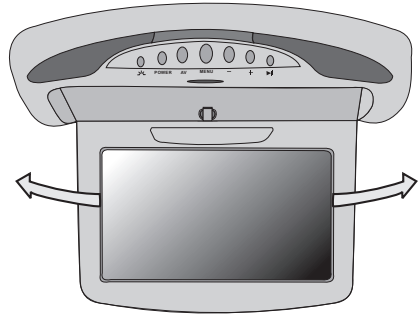
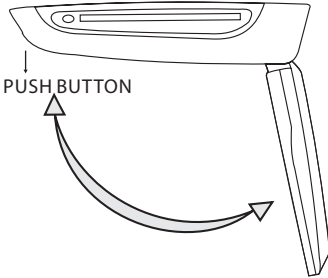

● How To Watch Monitor

1. Connect the monitor to external devices.
2. Press the POWER button on either the remote control or the unit once to turn the power on.
Press the same POWER button to turn the power off.

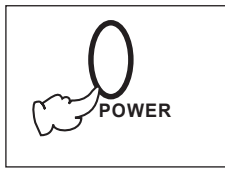

UNIT

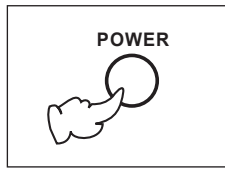

REMOTE CONTROLLER

3. Power on the external devices and play.

● Mute Function

Mute the audio sound.

1. Press the **MUTE** button on the remote control to mute the audio.

When the mute is on, press the **MUTE** button again on the remote control to play the audio.

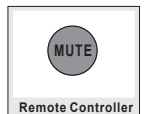

● AVC (DVD/AV1/AV2) Mode

1. Connect the external devices as shown in the picture on the right.
(Refer Connection Diagram).

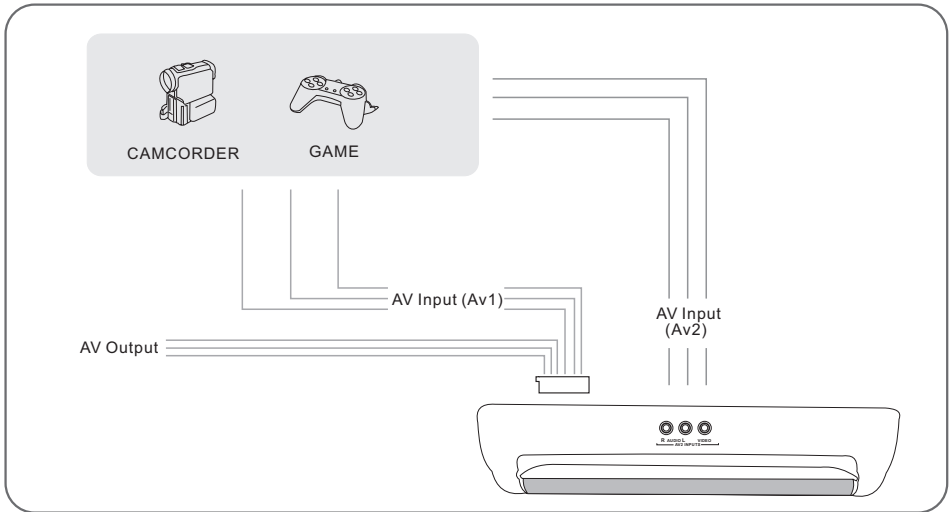

2. Turn the power ON the unit and external devices.

3. Select the DVD/AV1/AV2 mode by pressing the AVC button on the unit or on the remote control.

4. Play the external device.

Picture Control

● CONTRAST/BRIGHTNESS/COLOR/FM

Select the one of **CONTRAST/BRIGHTNESS/COLOR/FM** and change the picture condition as your taste.

1. Bring up the on-screen function menu by pressing the MENU button on the unit or the remote control of monitor.

CONTRAST



2. Select the desired menu by pressing the MENU button on the unit or the remote control of monitor.

BRIGHTNESS



3. Select the desired menu by pressing the MENU button on the unit or the remote control of monitor.

COLOR



4. Select the desired menu by pressing the MENU button on the unit or the remote control of monitor.

FM

87.9 ▶

(FM function added 88.4▶87.9▶88.1▶88.3MHz)

5. Select the desired menu by pressing the MENU button on the unit or the remote control of monitor.

Reset

■ Setup Menu-Main Page

⊖ An invalid button press.

When the **SETUP** button is pressed, the setup menu will display as shown below. Select the menu category and modify according to individual preference.

1. Press the **STOP** button if the disc is playing.
2. Press the **SETUP** button to display setup menu.

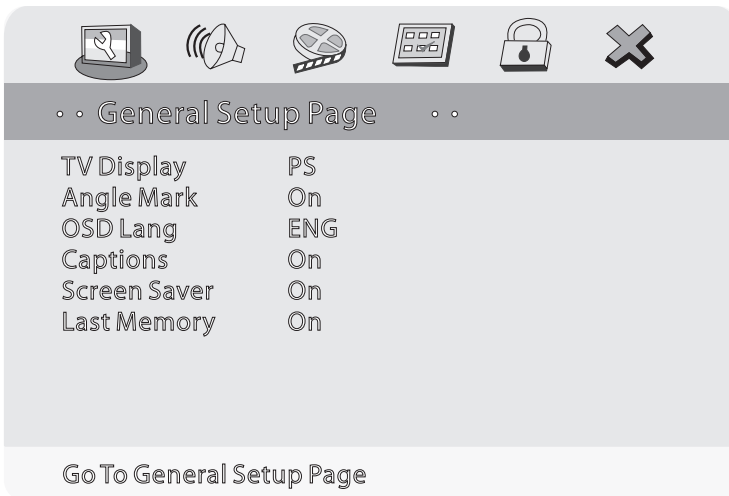

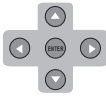
2. Use the  button to select and set desired setting and items.

3. Press the **SETUP (A.MEMO)** button again to turn off the setup menu.

■ General Setup

1. TV Display

You can select a TV screen aspect ratio according to your TV.
If the TV on which the movie is player -WIDE type, choose -EIDE. If it is of 4:3 type, choose NORMAL/PS (Pan&Scan) or NORMAL/LB(Letter BOX).



Normal / PS 4:3 PAN SCAN

Choose this setting if you want the movie to fill the entire screen.
(This might mean that the left and right edges won't be seen)



Normal / LB 4:3 LET TERBO

Choose this setting if you want to see movie in their original aspect ratio.
(The movie might appear with black bars at the top and bottom of the screen.)



Wide 16:9 WIDE SCREEN

Choose this setting if your DVD Player is connected to a widescreen TV.
(This option is available only if the disc has a 16:9 display aspect ratio.)



Wide 16:9 Squeeze

Choose this setting if your DVD Player is connected to a widescreen TV.
(This option is available only if the disc has a 16:9 display aspect ratio.)

Caution

This option is available only when the disc has the function.

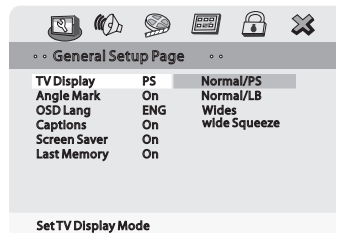

2. Angle Mark

You can set up so that the angle mark appears on scenes.

On : When selected, the screen will be shown with angle mark.

Off : When selected, no angle mark is shown on the screen.

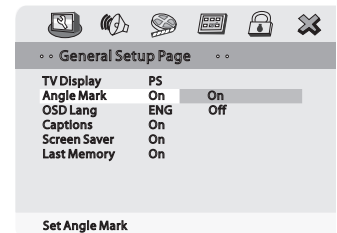

3. OSD Lang

Use this option to set the OSD language.

When selected, change to set the on-screen display language.

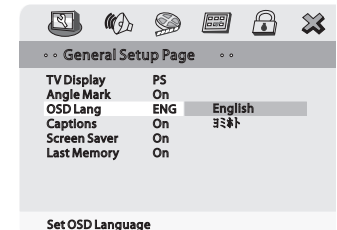

4. Captions

Adjust caption selection.

On: Choose this setting to display captions.

Off: Choose this setting to close captions.

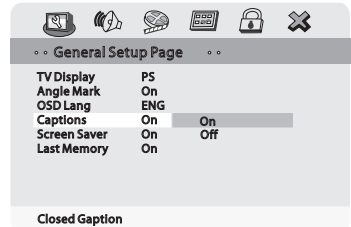

5. Screen Saver

The screen saver is useful to prevent your display from becoming damaged. The screen saver picture appears when you leave the DVD player in stop mode for about two minutes.

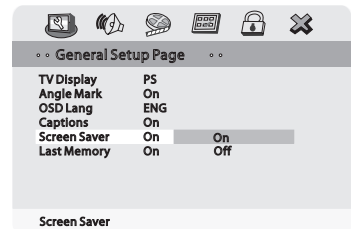

6. Last Memory

Adjust last memory selection.

When start your car or turn on/off the DVD player, search the last player scene.

When eject and close the disc, this function is not working.

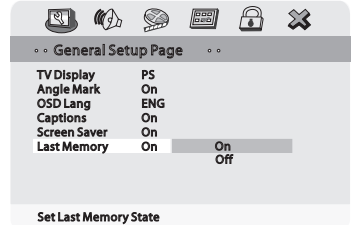

Audio Setup

Caution

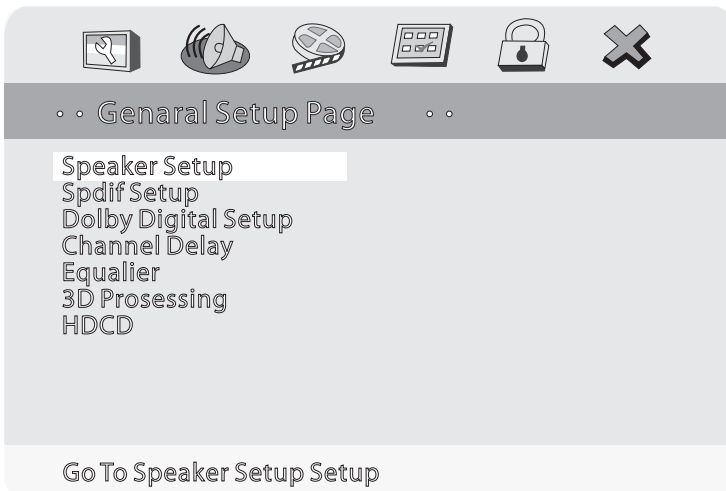

DVD setup

In order to understand all the FUNCTIONS well, we select two (Dolby Digital Setup and Equalizer) of them.

1. Dolby Digital Setup

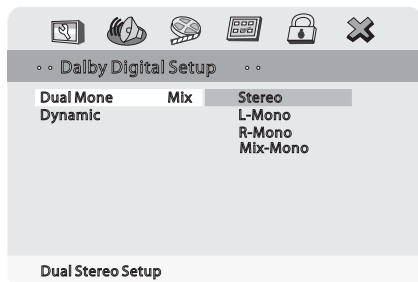
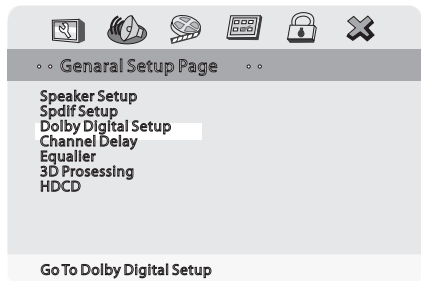

Dual Mono

Use this function to set the input audio signal to fit into the speaker.

Dynamic

Use this function to change the setting from the factory.-Preset Off position.

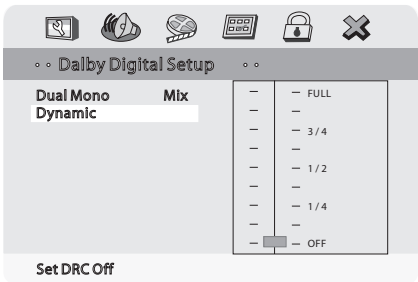
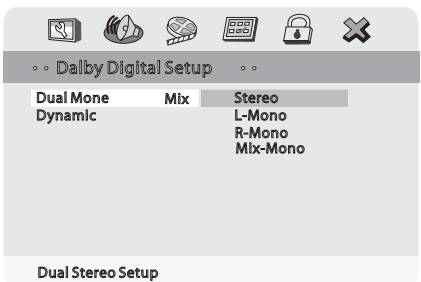

2. Equalizer

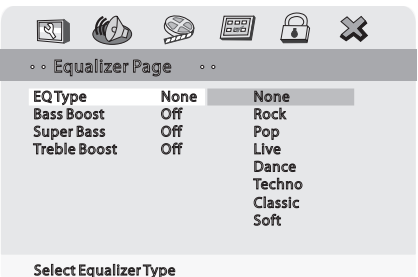
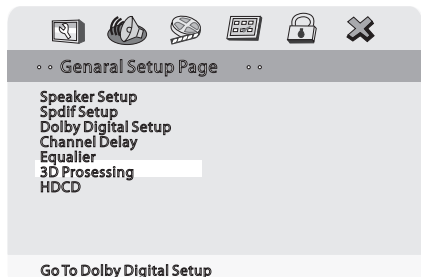

EQ Type

This unit can product a 3D surround effect, using 3D Surround Sound technology.

Choose the desired preset equalizer mode.
(None, Rock, Pop, Live, Dance, Techno, Classic, Soft)

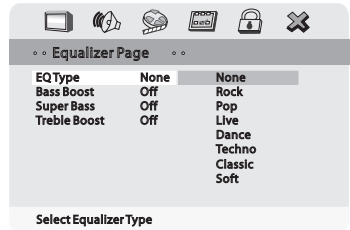

Bass Boost

This Function is enhanced at low levels without distorting other frequencies.

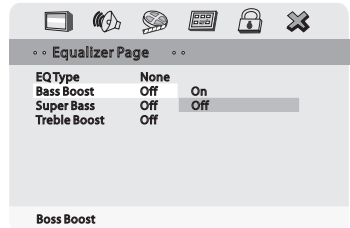

Super Bass

This function is more enhanced at low levels without distorting other frequencies.

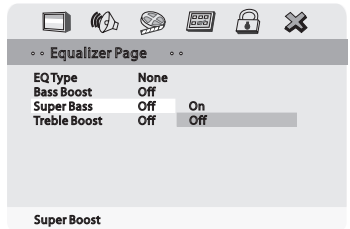

Treble Boost

This function is enhanced at high levels without distorting other frequencies.

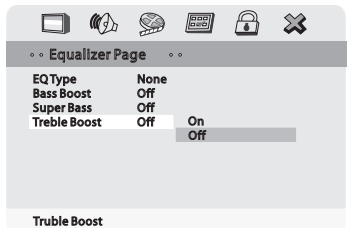

■ Video Setup

Caution

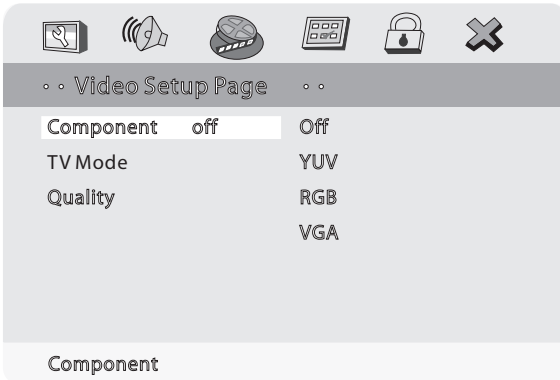

In order to understand all the FUNCTIONS well, we select the one (Quality) of them.

1. Quality

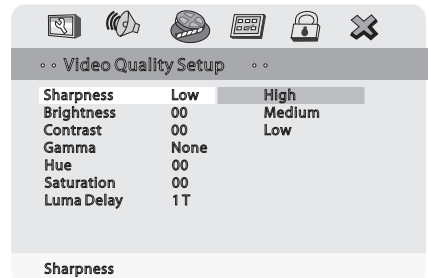
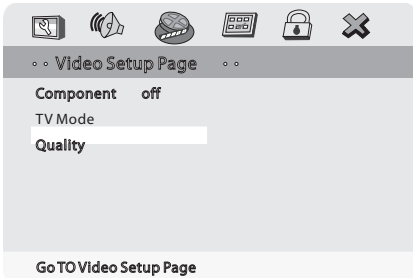

Sharpness

Use this option to select screen sharpness.

Select screen sharpness using the direction ▲ / ▼ buttons and press the ENTER button..

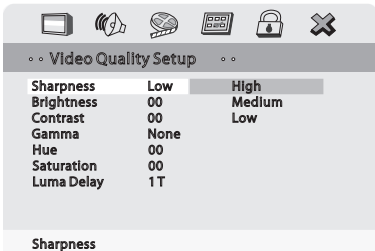

DVD setup

Gamma

Select screen gamma using the direction ▲/▼ buttons and press the ENTER button. Gamma adjustment is to revive the dark screen section by raising the level of dark section, while leaving the bright screen section unchanged.

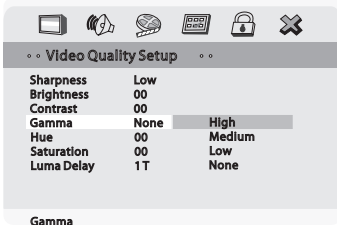

Gamma

Hue

Select screen hue level using the direction ◀/▶ buttons and press the ENTER button.

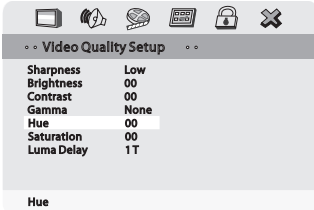

Hue

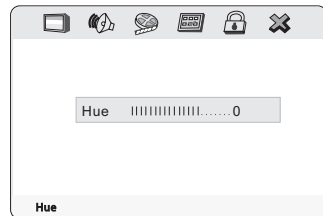

Hue

Saturation

Select screen saturation level using the direction ◀/▶ buttons and press the ENTER button.

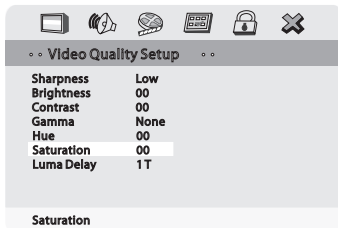

Saturation

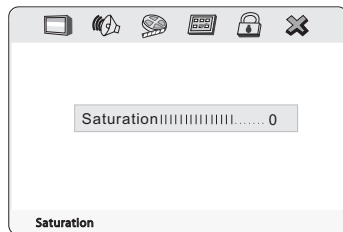

Saturation

Luma Delay

Select the Luma Delay menu and select the preferred video image quality.

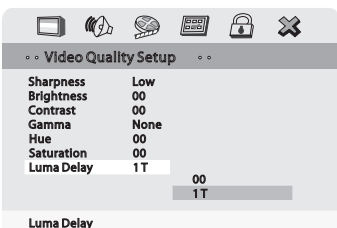

Luma Delay

Preference

1. TV Type

Choose a proper operating setting according to the color system of the TV Type-Multi system. MTSC,PAL.

- 1) Press the SETUP button during stop mode.
- 2) Press the ◀ / ▶ buttons to move to Preference.
- 3) Press the ▲ / ▼ buttons to move to TV Type.
- 4) Press the ENTER button.
- 5) Press the ▲ / ▼ buttons to select TV Type.

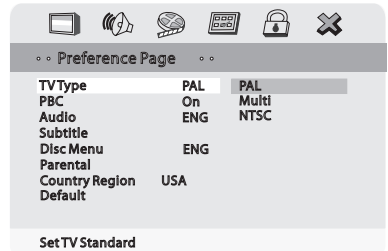

2. PBC (Play Back Control)

This feature is only available when a (Super)Video CD is loaded. It allows you to disable or enable the PBC(Play Back Control)menu of VCD discs.

- 1) Press the SETUP button during stop mode.
- 2) Press the ◀ / ▶ buttons to move to Preference.
- 3) Press the ▲ / ▼ buttons to move to PBC.
- 4) Press the ENTER button.
- 5) Press the ▲ / ▼ buttons to select TV Type On/Off.

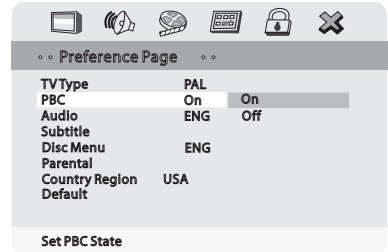

3. Audio

Use the audio language menu to select the subtitle language that you prefer. If the disc you are playing has that language available, it will display subtitles in that language.

- 1) Press the SETUP button during stop mode.
- 2) Press the ◀ / ▶ buttons to move to Preference.
- 3) Press the ▲ / ▼ buttons to move to Audio.
- 4) Press the ENTER button.
- 5) Press the ▲ / ▼ buttons to select desired audio language.

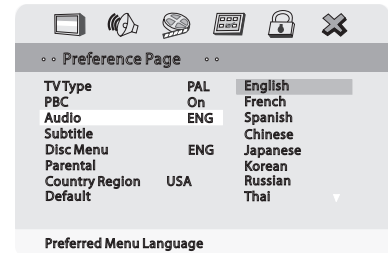

4. Subtitle

Use the subtitle language menu to select the subtitle language that you prefer. If the disc you are playing has that language available. It will display subtitles in that.

- 1) Press the SETUP button during stop mode.
- 2) Press the ◀ / ▶ buttons to move to Preference.
- 3) Press the ▲ / ▼ buttons to move to Subtitle.
- 4) Press the ENTER button.
- 5) Press the ▲ / ▼ buttons to select desired subtitle.

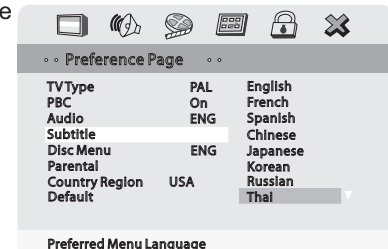

DVD setup

5. Disc Menu

Use the Disc Menu option to select the language you want a DVD's disc menu to be displayed in (not the same as the player menu)

- 1) Press the SETUP button during stop mode.
- 2) Press the ◀ / ▶ buttons to move to Preference.
- 3) Press the ▲ / ▼ buttons to move to Disc Menu.
- 4) Press the ENTER button.
- 5) Press the ▲ / ▼ buttons to select Disc Menu.

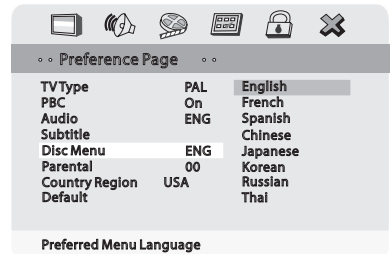

6. Parental

The Parental feature is a rating limit system, like movie ratings. It works with DVD's that have been assigned a rating. This option lets you determine how your player will react to discs that contain movies that are rated (in the U.S.A., the Motion Picture Association of America rates movies as G, PG, PG-13, etc.). You decide which ratings require a password and which ones don't.

- 1) Press the SETUP button when stop mode.
- 2) Press the ◀ / ▶ buttons to move to Preference.
- 3) Press the ▲ / ▼ buttons to move to Parental.
- 4) Press the ENTER button.
- 5) Press the ▲ / ▼ buttons to select desired parental level.

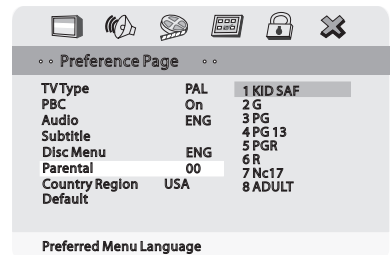

7. Country Region

Select parental region by pressing Country Region on the screen.

- 1) Press the SETUP button when stop mode.
- 2) Press the ◀ / ▶ buttons to move to Preference.
- 3) Press the ▲ / ▼ buttons to move to Country Region.
- 4) Press the ENTER button.
- 5) Press the ▲ / ▼ buttons to select desired Country Region.



8. Default

If user selects reset from the setup menu, all the value of setup menu will be initialized by factory setting value. (Exception: Parental level, Region code and Password values will not be changed)

- 1) Press the SETUP button when stop mode.
- 2) Press the ◀ / ▶ buttons to move to Preference.
- 3) Press the ▲ / ▼ buttons to move to Default.
- 4) Press the ENTER button to select reset.

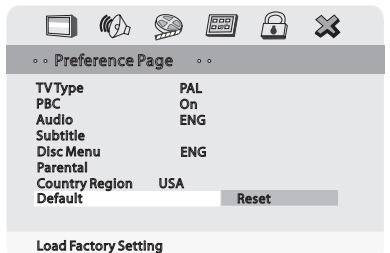

■ Password Setup

1.Password Mode

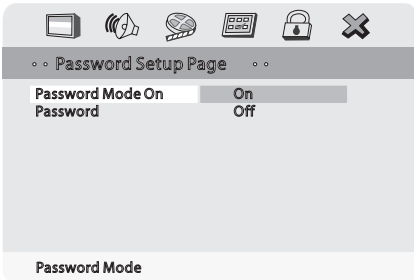

2.Password Change

- 1) Select Password Setup sub item.
- 2) Enter your old password, and new password in 6 digits.
(The default password code is 000000)
- 3) Re-enter new password for confirmation then press the ENTER button.

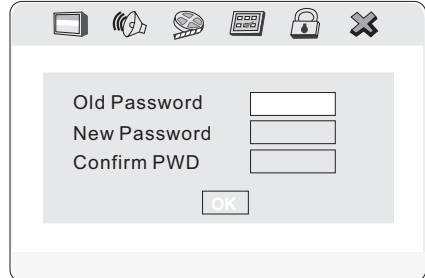
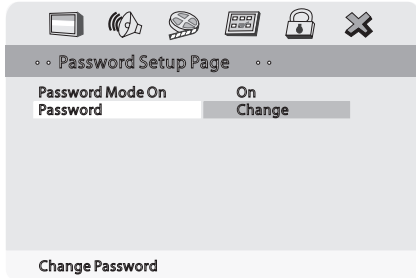

DVD functions

EJECT

Pressing the EJECT button changes the play mode as the text to the right illustrates. When you insert your DVD disc into the DVD player, "LOADING" will appear on the screen. Then the DVD disc is player automatically.

VOL+/VOL-

To adjust the audio output level of the speaker from 0 to 20.

MUTE

Pressing of the MUTE button changes the play mode.

OSD	CONDITION
Mute	Mute
Mute off	Mute off

PLAY OR PAUSE (▶/⏸)

[DVD]/[AUDIO]/[MP3]

Use this button to select a particular scene or play the disc. Most DVD discs will play automatically.

OSD	CONDITION
▶	Play Disc
⏸	Pause

AUDIO

[DVD]

Change the audio output type.
(If the loaded disc supports available audio type.)

[VCD]/[AUDIO]

Changes the audio output type.
(If loaded disc supports available audio type.)

[Mp3] ⓪

An invalid button press.

OSD	CONDITION
1 / 2 : Ac3 2CH English	2 Channel
2 / 2 : Ac3 5.1CH English	5.1 Channel

OSD	CONDITION
Stereo	Stereo
Mono Left	Mono Left
Mono Right	Mono Right
Mix Mono	Mix Mono

STOP(■)

[DVD]/[AUDIO]

Press the STOP button and stop the movie.
And then Press the Play/Pause button and will display the last scene of the movie.
Press the Stop button two times and stop the movie. And then Press the Play/Pause button and will display the first scene of the movie.

OSD	CONDITION
1 Time Press Play Key To Continue	Stop
2 Time	Disc Stop

[Mp3]

Press the STOP button and stop the Disc.
And then Press the Play/Pause button and will display the first file of the Disc.

OSD	CONDITION
1 Time Stop	Stop

ARROWS(◀/▶/⏪/⏩)

[DVD]

When display the DVD in ZOOM mode, you can change position by using ARROW button.

[AUDIO] ∅

An invalid button press.

[Mp3]

After pressing STOP button, select the desired folder and set the condition by pressing ENTER button.

SETUP

Use to set various functions according to your individual preference.

MENU

[DVD]

The menu of a DVD disc varies.
The content of the menu on the screen is dependent on the particular DVD.

[AUDIO]/[MP3] ∅

An invalid button press.

DVD functions

DISPLAY

[DVD]

Pressing button DISPLAY on the remote control changes the play mode as follows:

OSD	CONDITION
Title Elapsed	Display the Title Elapsed
Title Remain	Display the Title Remain
Chapter Elapsed	Display the Chapter Elapsed
Chapter Remain	Display the Chapter Remain
Display Off	No sign

[VCD]

Whenever press the button, title chapter will be displayed as follows:

OSD	CONDITION
Single Elapsed	Display time
Single Remain	Left display time
Display Off	No sign

[AUDIO]

Pressing display button displays information about the current CD on the screen as follows:

OSD	CONDITION
Single Elapsed	Display the single elapsed
Single Remain	Display the single remain
Total Elapsed	Display the total elapsed
Total Remain	Display the total remain

[Mp3]

Your DVD player will display the counter automatically when you play the Mp3 disc.

NUMBER BUTTONS

[DVD]

The 0 through 9 number buttons are used to enter the number of the track, the number of the DVD chapter, time date, etc.

[AUDIO]

You can select a track by pressing the corresponding number button.

OSD	CONDITION
Select Track: __	Select track no

[DVD]

You can select a track in the folder by pressing the corresponding number button.

OSD	CONDITION
__:__	Select track no

SUBTITLE(SUB-T)

[DVD]

This button is used to select the language for on-screen display message.
(This title menu is different, depending on the particular DVD.)

[AUDIO]/[MP3]∅

An invalid button press.

TITLE

[DVD]

Used to display the title menu of the loaded DVD disc.
(This function is disc-dependent.)

[AUDIO]/[MP3]∅

An invalid button press.

SLOW(▶)

[DVD]/[VCD]

Used to play a disc in slow forward or slow reverse.
This allows you to search forward three steps to
reverse three steps.

Slow forward play: press slow button.

Slow rewind play: press slow button and forward
button again. (not in work VCD)

[AUDIO]/[MP3]∅

An invalid button press.

OSD	CONDITION
▶ 1 / 2	2X slow forward
▶ 1 / 4	4X slow forward
▶ 1 / 8	8X slow forward
▶ 1 / 16	16X slow forward
◀ 1 / 2	2X slow rewind
◀ 1 / 4	4X slow rewind
◀ 1 / 8	8X slow rewind
◀ 1 / 16	16X slow rewind
Play	Play

DVD functions

FAST REVERSE SEARCHING(↶)

[DVD]

Pressing FR button changes the play mode as follow:

OSD	CONDITION
FR 2X	2X rewind search
FR 4X	4X rewind search
FR 8X	8X rewind search
FR 16X	16X rewind search
FR 32X	32X rewind search
PLAY	Play

[AUDIO]

Pressing FR button changes the play mode as follow:

OSD	CONDITION
FR 2X	2X rewind search
FR 4X	4X rewind search
FR 8X	8X rewind search
FR 16X	16X rewind search
FR 32X	32X rewind search
PLAY	Play

[Mp3]

Pressing FR button changes the play mode as follows:

OSD	CONDITION
FR 2X	2X rewind search
FR 4X	4X rewind search
FR 8X	8X rewind search
FR 16X	16X rewind search
FR 32X	32X rewind search
PLAY	Play

FAST FORWARD SEARCHING(↷)

[DVD]

Pressing FR button changes the play mode as follow:

OSD	CONDITION
FF 2X	2X forward search
FF 4X	4X forward search
FF 8X	8X forward search
FF 16X	16X forward search
FF 32X	32X forward search
PLAY	Play

[AUDIO]/[VCD]

Pressing FR button changes the play mode as follow:

OSD	CONDITION
FF 2X	2X forward search
FF 4X	4X forward search
FF 8X	8X forward search
FF 16X	16X forward search
FF 32X	32X forwardsearch
PLAY	Play

[Mp3]

Pressing FR button changes the play mode as follows:

OSD	CONDITION
FF 2X	2X forward search
FF 4X	4X forward search
FF 8X	8X forward search
FF 16X	16X forward search
FF 32X	32X forwardsearch
PLAY	Play

PREV(⏮)

[DVD]/[VCD]

Used to move to the previous chapter from the current chapter.

[AUDIO]/[MP3]

Used to move to the previous track.

NEXT(⏭)

[DVD]/[VCD]

Used to move to the next chapter from the current chapter.

[AUDIO]/[MP3]

Used to move to the next track from the current track.

REPEAT(A-B)

[DVD]/[VCD]/[AUDIO]

Press this button to repeat the selected segment.
The selected segment will be repeated automatically until canceled.

[Mp3] ⓪

An invalid button press.

OSD	CONDITION
A	Start point of repeat
A B	Ending point repeat function

DVD functions

REPEAT

[DVD]

Pressing REPEAT button changes the play mode as follow:

OSD	CONDITION
<input type="radio"/> Chapter	Repeat chapter
<input type="radio"/> Title	Repeat title
<input type="radio"/> All	All
	Repeat off

[VCD] \emptyset

An invalid button press.

[AUDIO]

Pressing REPEAT button changes the play mode as follow:

OSD	CONDITION
Track	Repeat single
All	All
	Repeat off

[Mp3]

Use to change the play mode.
Pressing REPEAT button changes the play mode as follows:

OSD	CONDITION
Repeat One	Single
Repeat Folder	Repeat folder
Folder	Repeat folder one time
Shuffle	All
Random	Random play
Single	Single play

NTSC/PAL

Select the NTSC/PAL/MULTI in condition of DVD mode.

ANGLE

Select ON for watching other camera angle.
This button can't control the preset camera angle.

PBC

[DVD]/[AUDIO]/[MP3] 

An invalid button press.







[VCD]

You can turn the PBC (Play Back Control) function on or off by pressing this button. When PBC is loaded, the PBC function is enabled automatically. This function is similar as selection of DVD title. (not available with Mp3)

ZOOM

[DVD]

Pressing ZOOM button changes the play mode as the text to the right illustrates.

OSD	CONDITION
 2 X	ZOOM X 2
 3 X	ZOOM X 3
 4 X	ZOOM X 4
 1 / 2	ZOOM X 1 / 2
 1 / 3	ZOOM X 1 / 3
 1 / 4	ZOOM X 1 / 4
	Off

[VCD]/[AUDIO]/[MP3] 

An invalid button press.

GOTO

When Watching DVD available to control the Menu.

Title

Move to the desired title.

Chapter

Move to the desired chapter.

Audio

Selects the desired audio output.

Subtitle

Select the desired subtitle.

Angle

Watch the different view angle.

TT Time

Total time.

CH Time

Chapter time.

Repeat

Sets the repeat play.

Time Display

Watch play time.

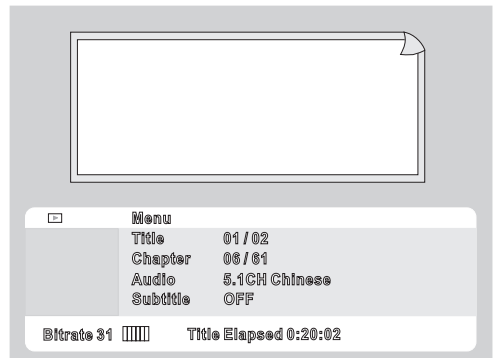

Connection diagram

On a towel or soft cloth, gently place the monitor assembly “face down” on a stable work surface.

Using the wires provided, complete the audio, video and power connections in your vehicle as shown in the diagram below.

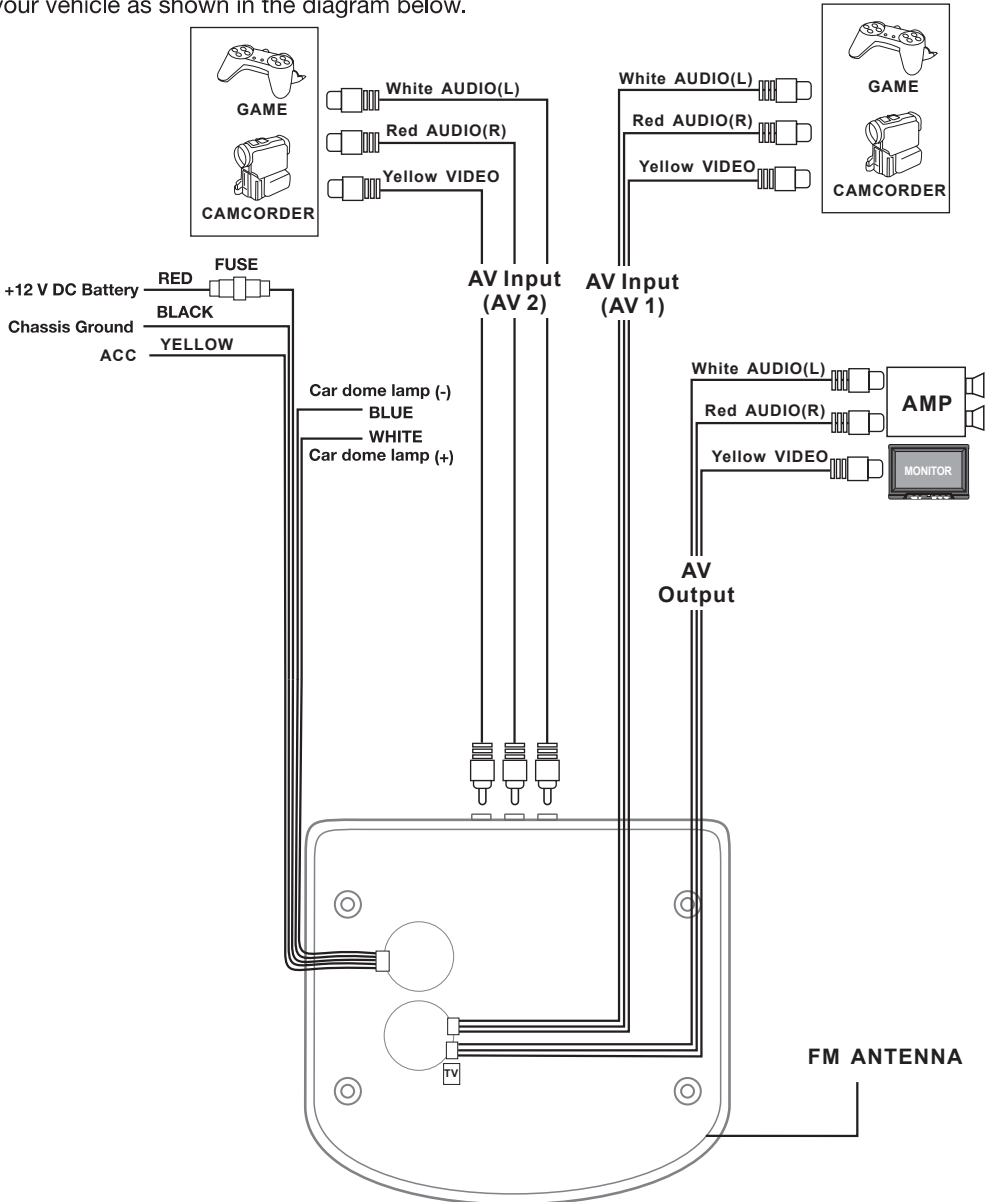

1. Open the color box and check the contents.

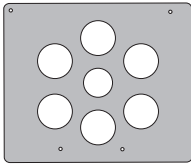

INSTALLATION PLATE

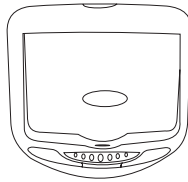

UNIT



SCREW A

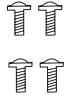

SCREW B

2. Connect the external devices RCA cable or AV output.
(refer the connection diagram)

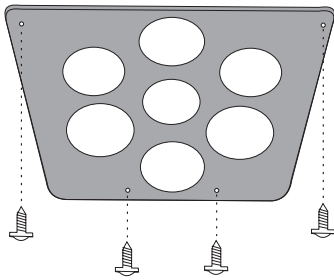

3. Match the position of installation bracket and installation plate with screw A.

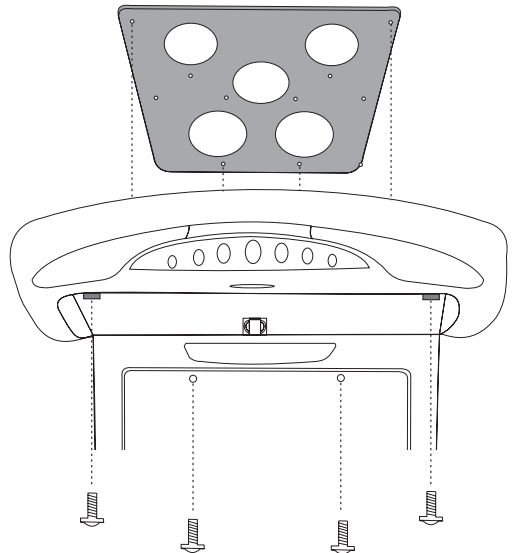

4. Tighten the unit with the supplied screw B.

Disc information

DVD features

DVD discs provide high-resolution images with high-quality sound and surround sound effects. This DVD player can play not only DVD discs of various versions, but also S-VCD, VCD, audio CD and Mp3 discs. Each disc plays only the information saved on it, and some functions cannot be utilized.

Discs that cannot be played

DVD-RW, DVD-REM, CD-ROM, CD-EXTRA discs cannot be played on this unit. Also, a CD or a CD-RW which was recorded on special software cannot be played.

Region code

Your DVD player is designed and manufactured to region management information that is recorded on a DVD disc. Please check the region code.

1: North America 2: Japan 3: Korea and Southeast Asia
4: Australia, Mid & South America 5: Russia 6: China

Copyright protection

This product incorporates copyright protection technology that is protected by methods claims of certain U.S. Patents and other intellectual property rights owned by the Macrovision Corporation and other rights. Owner's use of this copyright protection technology must be authorized by the Macrovision Corporation, and is intended for home and other limited viewing uses only unless otherwise authorized by the Macrovision Corporation.

How to handle the disc

Don't touch the shiny side of the disc (the side with the embedded information).
Don't stick a label or a glue-based note on either side of the disc. Don't use discs that have glue or a damaged gluey label-it might result in damage to your DVD player.
Don't put discs in the sunshine. Park your car in the shade.

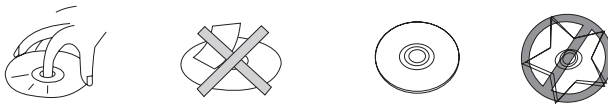

How to handle the disc

Wipe softly with a wet cloth and then with a dry one.
Before playback, wipe the disc outward from the center with a clean cloth.
Do not use any type of solvent such as thinner, benzene, commercially-available cleaners or antistatic spray.
To avoid damaging your DVD player, don't use a scratched disc.



Symptom	Items to Check	Actions to be Taken
Button does not work.	Is the power turned on?	Check the car battery capacity.
No sound	Is the audio which is connected with the audio cable set to receive the DVD signal output? Is audio cable is connected securely? Is the monitor which is connected with the audio cable turned on? Is the digital audio output set in the correct position?	Select the correct input mode for the audio receiver. Connect the audio cable into the jacks securely. Turn on the monitor connected with the audio cable. Set the Digital Audio Output to the correct position, and then turn on the DVD player again by pressing the POWER button.
Remote control does not work properly.	Is the remote contro facing at the remote sensor? Is the distance too far? Is there any obstacle in the middle? Is the battery exhausted?	Point the remote control to the remote sensor of the product. Use the remote control within 5m. Remove the obstacle. Replace with new batteries.
Unable to receive TV broadcasting.	Is the antenna connected properly?	Check antenna connection.



Check point

When a disc is brought from a cold environment to a hot one, there may be steam on the face of the disc, or water will appear on the pickup lens. It will be affected disc play.

1. Remove the disc from the DVD player.
2. Turn on the power and leave it on for an hour to vaporize the condensation.
3. You can operate the DVD player without any problems.

Specifications

Power	DC 12V
Screen Format	16:9
Resolution Pixel	1440x234
Color System	NTSC/PAL Auto Select
A/V Input	DVD-AV1-AV2
A/V Output	1 EA
Dimension	10.6(L)X9.9(W)X2.0(H)inch

Note : This equipment has been tested and has been found to comply with the limits for a Class A digital device, pursuant to part 15 of the FCC Rules. These limits are designed to provide reasonable protection against harmful interference when the equipment is operated in a commercial environment. This equipment generates, uses, and can radiate radio frequency energy and, if not installed and used in accordance with the instruction manual, may cause harmful interference to radio communications. Operation of this equipment in a residential area is likely to cause harmful interference in some cases the user will be required to correct the interference at his own expense.

NON-TRANSFERABLE LIMITED CONSUMER WARRANTY

Directed Electronics herein "Directed" promises to the original purchaser that the automotive video monitor and/or source unit(s) (the Product), excluding accessories, purchased and installed from a Directed authorized dealer within the ninety (90) days after purchase of the new vehicle, in which the Product is installed, is free from defects in materials or workmanship under normal use and conditions for a period of three (3) years from date of purchase or the first 36,000 miles as registered on the new vehicle's odometer reading at time of delivery of the Product for warranty service, whichever occurs first. Product purchased or installed more than ninety (90) days after the new vehicle is purchased are warranted for a period of one (1) year from date of purchase of the Product.

Directed promises to the original purchaser that all video accessories will be free from defects in materials and workmanship under normal use and condition for a period of ninety (90) days after the date of purchase. A sales receipt and/or warranty registration card is required to provide proof of date of purchase of the Product or accessories. Should the Product be determined defective during the applicable warranty period, the Product will be repaired or replaced with a new or comparable reconditioned part(s), at Directed's option. To obtain warranty service, the Product must be returned to a Directed authorized dealer along with proof of purchase and installation.

Note: This warranty does not cover labor costs for the removal and reinstallation of the Product. IN ORDER FOR THIS WARRANTY TO BE VALID, YOUR PRODUCT MUST BE SHIPPED WITH PROOF OF PURCHASE AND INSTALLATION BY AN AUTHORIZED DIRECTED DEALER. ALL PRODUCTS RECEIVED BY DIRECTED FOR WARRANTY REPAIR WITHOUT PROOF OF PURCHASE AND DIRECTED DEALER INSTALLATION WILL BE DENIED.

This warranty is non-transferable and does not apply to any Product that has been modified or used in a manner contrary to its intended purpose, and does not cover damage to the Product caused by installation or removal of the Product. This warranty is VOID if the product has been damaged by accident or unreasonable use, negligence, acts of God, neglect, improper service or other causes not arising out of defect in materials or construction. This warranty does not cover the elimination of externally generated static or noise, or the correction of antenna problems or weak television reception, damage to tapes, video games, software, camcorders, discs, speakers, accessories or vehicle electrical systems, cosmetic damage or damage due to negligence, misuse, abuse, failure to follow operating instructions, accidental spills or customer applied cleaners, damage due to environmental causes such as floods, airborne fallout, chemicals, salt, hail, windstorms, lightning or extreme temperatures, damage due to accidents, road hazards, fire, theft, loss or vandalism, damage due to improper connection to equipment of another manufacturer, modification of existing equipment, use of a faulty tape cartridge or cleaning of the VCR head, or Product which has been opened or tampered with for any reason or which has been damaged due to alteration or service performed by anyone other than Directed Electronics.

ALL WARRANTIES INCLUDING BUT NOT LIMITED TO EXPRESS WARRANTY, IMPLIED WARRANTY, WARRANTY OF MERCHANTABILITY, FITNESS FOR PARTICULAR PURPOSE, AND WARRANTY OF NON-INFRINGEMENT OF INTELLECTUAL PROPERTY ARE EXPRESSLY EXCLUDED TO THE MAXIMUM EXTENT ALLOWED BY LAW, AND DIRECTED NEITHER ASSUMES NOR AUTHORIZES ANY PERSON TO ASSUME FOR IT ANY LIABILITY IN CONNECTION WITH THE SALE OF THE PRODUCT. DIRECTED HAS ABSOLUTELY NO LIABILITY FOR ANY AND ALL ACTS OF THIRD PARTIES INCLUDING ITS LICENSED DEALERS OR INSTALLERS. IN NO EVENT WILL DIRECTED BE LIABLE FOR ANY INCIDENTAL, SPECIAL OR CONSEQUENTIAL DAMAGES (INCLUDING LOSS OF PROFITS). BY PURCHASING THIS PRODUCT, THE CONSUMER AGREES AND CONSENTS THAT ALL DISPUTES BETWEEN THE CONSUMER AND DIRECTED SHALL BE RESOLVED IN ACCORDANCE WITH CALIFORNIA LAWS IN SAN DIEGO COUNTY, CALIFORNIA.

Some states do not allow limitation on how long an implied warranty lasts. In such states, the limitations or exclusions of this Limited Warranty may not apply. Some states do not allow the exclusion or limitation of incidental or consequential damages. In such states, the exclusion or limitation of this Limited Warranty may not apply to you. This Limited Warranty gives you specific legal rights, and you may have other rights which vary from state to state.

Designed and Engineered in the USA

Directed[®]
E L E C T R O N I C S

N83800B 02-07

Free Manuals Download Website

<http://myh66.com>

<http://usermanuals.us>

<http://www.somanuals.com>

<http://www.4manuals.cc>

<http://www.manual-lib.com>

<http://www.404manual.com>

<http://www.luxmanual.com>

<http://aubethermostatmanual.com>

Golf course search by state

<http://golfingnear.com>

Email search by domain

<http://emailbydomain.com>

Auto manuals search

<http://auto.somanuals.com>

TV manuals search

<http://tv.somanuals.com>