



REMOTE START SYSTEM

[USER'S GUIDE]

M O D E L

259D

limited lifetime consumer warranty

For a period of one calendar year from the date of purchase of this auto-security device, Directed Electronics, Inc. promises to the ORIGINAL PURCHASER to repair or replace (with a comparable reconditioned model), free of cost, any electronic control module which proves to be defective in workmanship or material under normal use, SO LONG AS THE SYSTEM WAS SOLD, INSTALLED, AND SERVICED BY A PROFESSIONAL AUTO INSTALLER, AND REMAINS IN THE CAR IN WHICH THE SYSTEM WAS ORIGINALLY INSTALLED. If warranty service is necessary you must have a clear copy of your sales receipt containing all of the information shown on the following page.

After the first calendar year, from the date of purchase of this auto-security device, Directed Electronics, Inc., promises to the ORIGINAL PURCHASER to repair or replace (with a comparable reconditioned model) any electronic control module which proves to be defective in workmanship or material under normal use FOR A CHARGE OF \$45.00, SO LONG AS THE SYSTEM WAS SOLD, INSTALLED, AND SERVICED BY A PROFESSIONAL AUTO INSTALLER, AND REMAINS IN THE CAR IN WHICH THE SYSTEM WAS ORIGINALLY INSTALLED. If warranty service is necessary you must have a clear copy of your sales receipt containing all of the information shown on the following page.

This warranty contains the entire agreement relating to warranty and supersedes all previous and contemporaneous representations or understandings, whether written or oral. IN ANY EVENT, DEI IS NOT LIABLE FOR THE THEFT OF THE VEHICLE AND/OR ITS CONTENTS.

This warranty is void if the product has been damaged by accident, unreasonable use, neglect, improper service or other causes not arising out of defects in materials or construction. This warranty is nontransferable and does not apply to any unit that has been modified or used in a manner contrary to its intended purpose and does not cover batteries. The unit in question must be returned to the manufacturer, postage prepaid. This warranty does not cover labor costs for the removal, diagnosis, troubleshooting or reinstallation of the unit. For service on an out-of-warranty product a flat rate fee by model is charged. Contact your authorized dealer to obtain the service charge for your unit.

These systems are a deterrent against possible theft. Directed Electronics, Inc. is not offering a guarantee or insuring against the theft of the automobile or its contents and disclaims any liability for the theft of the vehicle and/or its contents. Directed Electronics does not authorize any person to create for it any other obligation or liability in connection with this security system.

TO THE MAXIMUM EXTENT ALLOWED BY LAW, ANY AND ALL WARRANTIES ARE EXCLUDED BY THE MANUFACTURER AND EACH ENTITY PARTICIPATING IN THE STREAM OF COMMERCE THEREWITH. THIS EXCLUSION INCLUDES BUT IS NOT LIMITED TO THE EXCLUSION OF ANY AND ALL WARRANTY OF MERCHANTABILITY AND/OR ANY AND ALL WARRANTY OF FITNESS FOR A PARTICULAR PURPOSE AND/OR ANY AND ALL WARRANTY OF NON-INFRINGEMENT OF PATENTS, IN THE UNITED STATES OF AMERICA AND/OR ABROAD. NEITHER THE MANUFACTURER OR ANY ENTITIES CONNECTED THEREWITH SHALL BE RESPONSIBLE OR LIABLE FOR ANY DAMAGES WHATSOEVER, INCLUDING BUT NOT LIMITED TO ANY CONSEQUENTIAL DAMAGES, INCIDENTAL DAMAGES, TOWING, REPAIR, REPLACEMENT, DAMAGES FOR LOSS OF TIME, LOSS OF EARNINGS, COMMERCIAL LOSS, LOSS OF ECONOMIC OPPORTUNITY AND THE LIKE. NOTWITHSTANDING THE ABOVE, MANUFACTURER DOES OFFER A LIMITED WARRANTY TO REPLACE OR REPAIR THE CONTROL MODULE AS DESCRIBED ABOVE. Some states do not allow limitations on how long an implied warranty will last or the exclusion or limitation of incidental or consequential damages. This warranty gives you specific legal rights, and you may also have other rights which vary from state to state.

IMPORTANT NOTE:

This product warranty is automatically void if its date code or serial number is defaced, missing, or altered. This warranty will not be valid unless you have completed the warranty card and mailed it to Directed Electronics, Inc. within 10 days after purchase to the address listed on the warranty registration card.

Make sure you have all of the following information from your dealer:

A clear copy of the sales receipt, showing the following:

- > Date of purchase
- > Your full name and address
- > Authorized dealer's company name and address
- > Type of alarm installed
- > Year, make, model and color of the automobile
- > Automobile license number
- > Vehicle identification number
- > All security options installed on automobile
- > Installation receipts

table of contents

what is included	2
installation tools	2
important information	2
system maintenance	3
your warranty	3
fcc/id notice	4
warning! safety first	4
primary harness (H/1), 8-pin connector	6
secondary harness (H/2), 6-pin connector	7
relay satellite ribbon harness (H/3), 5-pin connector	7
relay satellite thick gauge wires	8
installation	8
step 1	10
step 2	10
step 3	13
step 4	14
step 5	18
step 6	19
step 7	21
step 8	23
step 9	24
step 10	25
transmitter functions	26
standard configuration	27
transmitter/receiver learn routine	28
using your system	30
locking/arming	30
unlocking/disarming	30
ignition-controlled door locks	31
remote start	31
timer mode	32
valet take-over	34
features menu	34
rapid resume logic	35
programming options	36
troubleshooting	36
glossary of terms	39
security & convenience expansions	40
wiring quick reference guide	42
notes	43
quick reference guide	45

what is included

- Control Module
- One Two-Button Transmitter
- 8-Pin Main H/1 Harness
- 6-Pin H/2 Secondary Harness
- Plug-in Status LED
- Relay Satellite Pack
- Shutdown Toggle Switch
- Plug-in Valet/Program Button

installation tools

- Digital Multi-Meter
- Drill
- $\frac{1}{32}$ and $\frac{1}{16}$ Drill Bits
- Screwdrivers
(Phillips and Flathead)
- Wire Stripper
- Solder Iron
- Electrical Tape
- Pliers
- Crimping Tool



note: The installation tools required will vary depending on your vehicle.

important information

Congratulations on the purchase of your remote start keyless entry system. This system will allow convenient access to your vehicle with the push of a button, as well as remote start and other optional features. Properly installed, this system will provide years of trouble-free operation.

Please take the time to carefully read this User's Guide in its entirety and watch the Rattler Do-It-Yourself Installation Video prior to installing your system.

You can print additional or replacement copies of this manual by accessing the Directed web site at www.diyrattler.com.

important! If you are not comfortable working with electronics or unfamiliar with the tools required, please contact your local dealer for advice or ask to have the remote start professionally installed to avoid costly damages. Failure to properly install the remote starter may result in property damage, personal injury, or both.

→ **system maintenance**

The system requires no specific maintenance. Your remote is powered by a miniature 12-volt battery (type GP23A) that will last approximately one year under normal use. When the battery begins to weaken, operating range will be reduced and the LED on the remote will dim.

→ **your warranty**

Your warranty registration must be completely filled out and returned within 10 days of purchase. Your product warranty will not be validated if your warranty registration is not returned. Please note that it is necessary to keep your proof of purchase.

→ **fcc/id notice**

This device complies with Part 15 of FCC rules. Operation is subject to the following conditions: (1) This device may not cause harmful interference, and (2) This device must accept any interference received, including interference that may cause undesired operation.

Changes or modifications not expressly approved by the party responsible for compliance could void the user's authority to operate this device.

warning! safety first

The following safety warnings must be observed at all times:

- When properly installed, this system can start the vehicle via a command signal from the remote control transmitter. Therefore, never operate the system in an area that does not have adequate ventilation. The following precautions are the sole responsibility of the user; however, the following recommendations should be made to all users of this system:

1. Never operate the system in an enclosed or partially enclosed area without ventilation (such as a garage).
 2. When parking in an enclosed or partially enclosed area or when having the vehicle serviced, the remote start system must be disabled using the toggle switch.
 3. It is the user's sole responsibility to properly handle and keep out of reach from children all remote control transmitters to assure that the system does not unintentionally remote start the vehicle.
 4. THE USER MUST INSTALL A CARBON MONOXIDE DETECTOR IN OR ABOUT THE LIVING AREA ADJACENT TO THE VEHICLE. ALL DOORS LEADING FROM ADJACENT LIVING AREAS TO THE ENCLOSED OR PARTIALLY ENCLOSED VEHICLE STORAGE AREA MUST AT ALL TIMES REMAIN CLOSED.
- Use of this product in a manner contrary to its intended mode of operation may result in property damage, personal injury, or death. Except when performing the Safety Check outlined in this user's guide, (1) Never remotely start the vehicle with the vehicle in gear, and (2) Never remotely start the vehicle with the keys in the ignition. The user will be responsible for having the neutral safety feature of the vehicle periodically checked, wherein the vehicle must not remotely start while the car is in gear. This testing should be performed by an authorized Directed dealer in accordance with the Safety Check outlined in this product installation guide. If

the vehicle starts in gear, cease remote start operation immediately and consult with the Dealer to fix the problem immediately.

- After the remote start module has been installed, test the remote start module in accordance with the Safety Check outlined in this installation guide. If the vehicle starts when performing the Neutral Safety Shutdown Circuit test, the remote start unit has not been properly installed. The remote start module must be removed or properly reinstalled so that the vehicle does not start in gear. OPERATION OF THE REMOTE START MODULE IF THE VEHICLE STARTS IN GEAR IS CONTRARY TO ITS INTENDED MODE OF OPERATION. OPERATING THE REMOTE START SYSTEM UNDER THESE CONDITIONS MAY RESULT IN PROPERTY DAMAGE OR PERSONAL INJURY. IMMEDIATELY CEASE THE USE OF THE UNIT AND REPAIR OR DISCONNECT THE INSTALLED REMOTE START MODULE. DIRECTED WILL NOT BE HELD RESPONSIBLE OR PAY FOR INSTALLATION OR REINSTALLATION COSTS.

*primary harness (H/1),
8-pin connector*

H1/1	BLACK	Ground
H1/2	WHITE/BLUE	Not Used
H1/3	LT. GREEN/BLACK	Factory Alarm Disarm
H1/4	YELLOW	Ignition Output
H1/5	WHITE	Light Flash Output
H1/6	GRAY/BLACK	Not Used
H1/7	LT. GREEN	Door Lock Output
H1/8	LT. BLUE	Door Unlock Output

*secondary harness (H/2),
6-pin connector*

H2/1	BLUE	Status Output
H2/2	BLUE/BLACK	Optional 3rd Ignition Output
H2/3	GRAY	Hood Pin Shutdown
H2/4	BROWN	Brake Shutdown
H2/5	VIOLET/WHITE	Tachometer Input
H2/6	BLACK/WHITE	Neutral Safety Input

relay satellite ribbon harness (H/3), 5-pin connector

H3/1	RED	(+) 12V Constant Power
H3/2	YELLOW	Ignition Input to Remote Start
H3/3	PINK	Ignition Relay Trigger
H3/4	ORANGE	Accessory Relay Trigger
H3/5	PURPLE	Starter Relay Trigger

relay satellite thick gauge wires

H4/1	RED	(+) 12V Constant Power INPUT
H4/2	RED	(+) 12V Constant Power INPUT
H4/3	PINK	Ignition 1 Output
H4/4	PINK/WHITE	Ignition 2 Output
H4/5	ORANGE	Accessory Output
H4/6	PURPLE	Starter Output

installation

Be sure to read this section thoroughly and view the Rattler Do-It-Yourself Installation Video in its entirety before starting the installation. Pay special attention to all warnings to prevent personal injury or damage to your vehicle.

Visit our 24-hour technical Web site (www.diyrattler.com) to get a vehicle-specific wiring guide prior to starting this installation. If at any time during the installation you are unable to answer your questions on the Web site, call **1-800-873-1314** for live technical assistance.



warning! This system is intended for automatic, fuel-injected vehicles only. Installation in any other vehicle is contrary to its intended use.



warning! On vehicles with air bags or supplemental restraint systems (SRS) you may notice a bright yellow tube with small wires in it marked SRS underneath the steering column near the key cylinder. DO NOT tamper or unplug these for any reason to prevent costly damages to your vehicle or personal injury. Tampering may cause unintended deployment of airbags.



warning! DO NOT use any testing tool other than a digital multi-meter to prevent costly damages to your vehicle. Use of a test light may cause grounding of sensitive electrical components that can damage the on-board vehicle computer and processors resulting in substantial cost for replacement.



warning! Verify that the vehicle is set to park and that the parking brake is set before beginning installation.

→ step 1

Ground Wire

The BLACK wire on the main 8-pin harness is ground. This wire should be connected to a clean, paint-free area of metal in the drivers kick panel area. First strip back a $\frac{3}{4}$ -inch section of the insulation off the BLACK wire and crimp a ring terminal (not provided) to that wire. Locate a clean, paint-free metal surface in the drivers kick panel. Using a self-tapping screw, drill the screw with the ring terminal to the metal area. Once screwed down, pull on the wire to ensure a good connection.

note: More problems are attributed to poor ground connections than any other cause. Take extra care to ensure the ground is clean and secure.

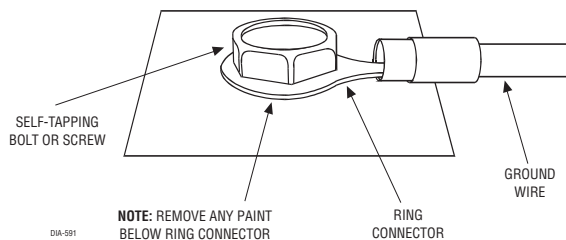

→ **step 2**

Constant Power and Ignition wires

Almost all power and ignition wires can be found behind the key cylinder under the lower drivers side dash panel. Using the appropriate hand tools, remove the lower dash panel using care not to break any parts. If the panel does not come off easily check for any additional screws you may have missed.

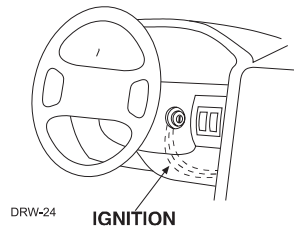

Once the lower dash panel has been removed, locate the ignition harness at the back of the key cylinder. This is usually a group of thicker wires. With the ignition harness exposed, use your digital multi-meter to find your power and ignition wires.

Place the black lead of the meter to a clean metal surface in the kick panel area and secure it. Put the meter in the DC voltage position, then take the red lead of the meter and probe one of the thicker gauge wires. The color and identity of your specific vehicle wiring can be obtained at www.diyrattler.com. With the key in the OFF position, test the suspect wire. The constant power wire will read between 11.00 volts and 13.00 volts regardless if the key is on or off.



warning! Before making any connection to constant battery power make sure that the two green 30 amp fuses are removed from the fuse holders on the two thick red wires. Failure to do so may cause fire or shorting of sensitive electrical components.

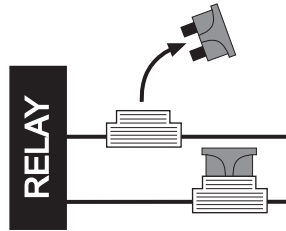

Once the constant power wire has been identified, solder the two thick RED wires from the relay satellite pack to it and cover the connection with electrical tape to ensure a safe connection.

With the meter black lead still in the kick panel, locate the ignition wire harness in the same location. It will test differently than constant (+)12 volts. Locate the suspected wire using the www.diyrattler.com Web site and place the red lead of the meter on the suspected wire. With the key in the off position the meter will read 0.00 volts. Turn the key to the on position and the meter should read between 11.00 volts and 13.00 volts. Now watching the meter, turn the key to the crank position and the voltage should drop a small amount but not disappear. If the voltage disappears this is not an ignition wire but an accessory wire. If the wire meters correctly, solder the thick PINK wire of the relay satellite pack to it and cover the connection with electrical tape.

If the vehicle requires more than one ignition as per the Web site information follow the same test procedure and solder the thick PINK/WHITE wire to it and be sure to cover your connection with electrical tape. If your vehicle requires more than two ignitions, contact Rattler Technical Support.

→ **step 3**

Accessory and Starter wires

The starter and accessory wires will be located in the same harness as the ignition and constant power. Leaving the meter black lead connected to the metal ground, take the red lead and probe the wire suspected to be the accessory. With the key off, your meter should read 0.00 volts. Turn the key to the on position and the meter should read between 11.00 volts and 13.00 volts. Now turn the key to the crank position. If you have the correct wire the voltage will disappear while the starter is cranking and return once the key returns to the on position. If the wire tests correctly, solder the thick ORANGE wire off the relay satellite pack and secure it with electrical tape. If your vehicle requires more than one accessory contact Rattler Technical Support.

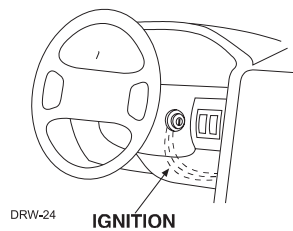

Now that the accessories have been located, find the wire suspected to be the starter wire according to the web information on your vehicle. Place the red lead of your meter on the wire. With the key in the off position the meter should read 0.00 volts and will stay at 0.00 volts in all key positions except the crank position. In the crank position your meter should read between 10.00 volts and 13.00 volts, and will drop back to 0.00 volts when the starter disengages. Once you locate the starter wire, cut the wire in half and try to start the vehicle. (Always check the Web site information on your vehicle for warnings regarding the starter wire and check engine lights. Some vehicles will trip a check engine light if the starter wire is cut.) If the vehicle does not start, the correct wire has been identified. Reconnect the starter wire while soldering the thick VIOLET wire off the relay satellite pack to it and cover the connection with electrical tape.

→ **step 4**

Safety Shutdown Wires

important! These wires are meant to protect the vehicle and anyone near the vehicle. They must be connected appropriately to prevent damage to the vehicle and possible bodily injury. Failure to properly install these wires may cause the vehicle to lunge if remote started while in gear.

With all ignition wires properly connected, find the appropriate safety shutdown wires. These include the brake wire, hood pin, and neutral safety wires.

First locate the factory brake wire using your multi-meter. Find the switch at the top of the metal arm coming off the brake pedal. There are usually two wires connected to that switch. Locate the wire color according to the web information. With your black meter lead still in the kick panel, probe the suspected wire with the red lead of your meter. With the brake pedal at rest it should read 0.00 volts. While watching the meter, depress the brake pedal. The meter should read between 10.00 volts and 13.00 volts. Once you have located the correct brake wire, solder the small BROWN wire on the secondary harness to it and tape the connection with electrical tape.

important! Do not use the vehicle until you confirm the operation of the brake shutdown.

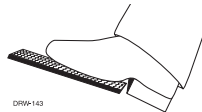

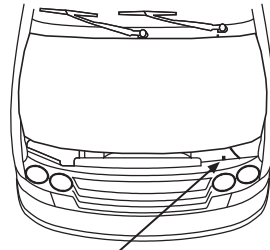

HOOD PIN
SWITCH

Installing the hood pin switch requires drilling a $\frac{1}{4}$ -inch hole in the metal lip under the hood. Choose a location that will allow the pin switch to be depressed when the hood is closed.

The pin switch has a connector on the bottom to connect to. Using a spade connector (included) strip back a $\frac{3}{4}$ -inch section of the insulation and crimp the connector on to the wire. Pull on the connector to ensure a good connection.

Place the connector onto the pin switch and run the wire into the vehicle through a factory rubber grommet. Using a sharp, pointed object poke a hole into the grommet and attach the wire to the object with electrical tape. Pull the wire through the grommet taking extra care to keep the wire away from any moving parts or anything that will generate extreme heat. Once the wire is run into the vehicle and secured from any moving parts, solder the wire to the GRAY wire on the secondary wire connector and cover the connection with electrical tape.

important! Do not use the vehicle until you confirm the operation of the hood pin shutdown.

The last safety shutdown wire is the neutral safety wire. This wire is extremely important as it prevents the vehicle from starting in gear which could cause serious bodily harm.

When determining the neutral safety wire it is important to test the vehicles starting circuit for factory neutral safety features. To do this, simply put the vehicle in gear and try to start the vehicle with the key. If the vehicle starts in gear there is no factory safeguards and the safety switch must be installed.



warning! The vehicle may lunge forward when started if there is no factory safeguards. Have the emergency brake engaged, and be prepared to quickly press on the brake and turn the engine off.

The after-market safety switch will have two wires coming off it. Take one of the wires (it does not matter which one) and strip back a 3/4-inch section of the insulation off the wire. Crimp a ring terminal to the wire, and using a self tapping screw, drill the screw with the ring terminal to the same area as the ground wire. Solder the other wire on the switch to the BLACK/WHITE wire on the secondary connector and cover the connection with electrical tape.

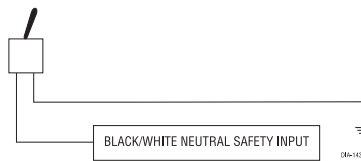

If the vehicle will NOT start in gear, the vehicle is equipped with a factory neutral safety circuit and will need to be located with the multi-meter.

The majority of neutral safety switches can be located at the steering column in the harness coming from the gear shift. With the meter black lead still in the kick panel, use the red lead of the meter to probe the suspected wires. The correct wire will show a small amount of voltage in any gear but once the gear shift is put in neutral or park it will read 0.00 Volts. After the correct neutral safety wire is properly identified, solder it directly to the BLACK/WHITE wire on the secondary connector and cover the connection with electrical tape.

The shut down toggle switch is designed to shut the remote start off in an emergency or to disable the remote start functions temporarily (i.e., for service on the vehicle).

If your vehicle came with a factory neutral safety switch this switch needs to be installed in line with the black/ white wire, instead of soldering the black/ white wire to the factory neutral safety wire solder the black/ white wire to one side of the switch (it does not matter which side) and solder the other side to the vehicle factory neutral safety switch.

important! Do not use the vehicle until you confirm the operation of the neutral safety feature.

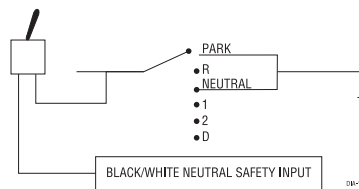

→ **step 5**

Parking light flash

There are several different types of parking light circuits. The following description is for a standard negative-triggered parking light circuit, usually located at the light switch. If the web vehicle information suggests a different type of parking light circuit, please contact Rattler Technical Support.

Using the web information on the vehicle, locate the suspected wire and place the red lead of the meter to a constant (+)12 volt source and secure it. Place the multi-meter in the DC position. Using the black lead of the meter, probe the wire. With the switch in the off position the meter will read 0.00 volts. While watching the meter, turn the switch to the parking light position. The meter will read between 10.00 volts and 13.00 volts.

Once you have identified the correct wire, solder the WHITE wire on the main connector to it and cover the connection with electrical tape.

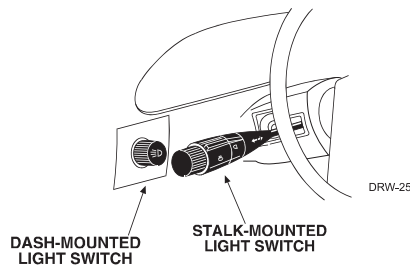

→ **step 6**

Door locks

Although there are numerous types of door lock circuits, the most common is the negative triggered door lock system. Check the web information on your vehicle to determine your door lock system type. If your vehicle has a negative triggered door lock system, follow the steps below. If your vehicle has any other type of door lock system, please contact Rattler Technical Support to obtain the correct door lock wiring diagram.

Locate the suspected lock wire, and with the red meter lead still secured to a (+)12 volt source, probe the suspect wire with the black lead of the meter. Press the door lock switch to the lock position and watch the meter display. The correct wire will show a 10.00 to 12.00 volt pulse when the switch is pressed.

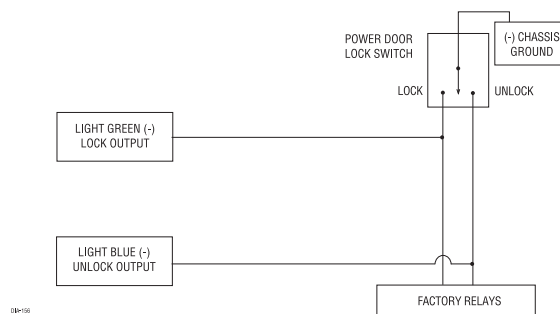

Once the correct wire has been found, solder the small LIGHT GREEN wire off the main connector to it and cover the connection with electrical tape.

Repeat this process for the unlock wire but press the switch to the unlock position when testing. Once you have identified the correct wire, solder the LIGHT BLUE wire off the main connector to it and cover the connection with electrical tape.

note: Additional parts may be required to interface with certain door lock types.

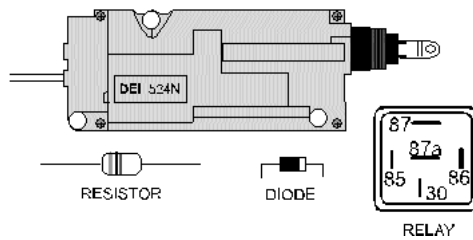

→ step 7

Engine monitoring

During remote start the system will need to know what the engine is doing and how fast it is idling in order to determine if the car is running. The module does this by monitoring the voltage of the vehicle's electrical system. When the vehicle is not running the electrical system should read approximately 12 volts and will increase up to 14.40 volts when running. The remote start system monitors the increase to prevent the starter from cranking when the vehicle is already running.

If the idle is too slow or too high, the system will shut down the engine to prevent damage. If the starter does not crank long

enough to actually start the engine, it is possible to change the programming to extend the crank time. Refer to the *Programming Options* section of this guide.

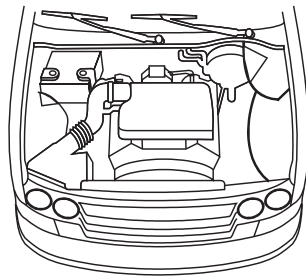

On some vehicles the electrical system has too low of a voltage variance for the remote start module to see. In this case the engine will not be protected from over cranking, over revolution, or under revolution of the engine.

If this is the case, it will be necessary to locate a tachometer wire in the vehicle using the multi-meter. Identify the suspect wire according to the web information. Then start the vehicle with the key and place the black lead of the multi-meter on the negative battery post and secure it. Put the multi-meter in the AC position and probe the suspect wire with the red lead of the multi-meter. With the engine at idle the multi-meter should read between .05 volts to 1.5 volts.

Have a second person press the gas pedal to increase the RPMs and watch the meter display. When the RPMs increase the

voltage should read between 1.5 volts and 2.9 volts. Once the correct tachometer wire has been identified, turn the vehicle off.

Run the VIOLET/WHITE wire through the firewall along side the hood pin wire. Then run it into the engine compartment through the factory rubber grommet used for the hood pin. Using a sharp pointed object poke thru the hole in the grommet and attach the VIOLET/WHITE wire to the object with electrical tape. Pull the wire through the grommet taking extra care to keep it away from any moving parts or anything that will generate extreme heat. Once the wire is run into the engine compartment, solder it to the tachometer wire and cover the connection with electrical tape. Pull on the wire to ensure a good connection.

Once the connection has been made it will be necessary to teach the tachometer signal to the remote start module. The remote start system must be completely installed, and the Valet/program button must be in a convenient location. When ready, start the vehicle with the key and within five seconds press and hold the Valet/program button. Once the LED turns on solid confirming that the tachometer signal has been learned, let go of the Valet/program button and turn the vehicle off. If the LED flickers or does not come on at all, an alternate tachometer wire will need to be found. Contact Rattler Technical Support for assistance.



warning! Do not use a test light. Use of a test light can cause grounding of sensitive electrical components causing damage, including damage to the power train control module.

→ **step 8**

Factory Alarm/Disarm

Since most newer vehicles come equipped with a factory alarm system, it is necessary for the factory alarm to be disarmed while remote starting the vehicle.

Locate the factory alarm disarm wire using the web vehicle information. Once the suspect wire is located, place the multi-meter's red lead to a (+)12 volt constant source and secure it. Put the multi-meter in the DC position then probe the suspect wire with the black lead of your meter. While probing the wire, place the key in the drivers door cylinder. Turn it to the unlock position and hold it. The multi-meter should read between 10.00 volts and 13.00 volts and will disappear when the key is released.

When the correct wire has been found, solder the small GREEN/BLACK wire to it and cover the connection with electrical tape.

→ **step 9**

Immobilizer Bypass Modules



warning! Any vehicle equipped with a factory immobilizer must use an immobilizer bypass module to remote start. If not used, the vehicle ignition or fuel supply circuits could lock up and require a costly trip to the dealer to reset the computer system.

Most newer vehicles have a factory engine immobilizer system designed to prevent any unauthorized use of the vehicle. These immobilizers will cut off power to the starter and the fuel supply preventing a thief from starting the vehicle.





There are several types of immobilizers, with the most common being the resistance based passlock/passlock 2 systems found on most newer GM vehicles. This system can be bypassed using the 557L immobilizer bypass module available at your local retail dealer. The majority of transponder-based immobilizer systems can be bypassed using the 557U immobilizer bypass module available at your local retail dealer.

To determine what bypass module your vehicle requires, check your web vehicle information sheet.

→ step 10

Testing the system

Once steps 1-9 have been completed, the operation of the system can be tested.

Place the two 30-amp fuses back into the relay satellite RED wire fuse holders. Make sure that the vehicle is in park with the emergency brake on and the hood closed. Press  and  on the remote control simultaneously to initiate the remote start function. The parking lights should flash to confirm the remote start command has been received, The accessories and ignition should turn on followed by the starter cranking and the vehicle engine running. Pressing  and  again simultaneously will shut the engine off.

transmitter functions

The receiver uses a computer-based learn routine to learn the transmitter buttons. This makes it possible to assign any specific transmitter button, or combination of buttons, to any receiver function. The transmitter initially comes programmed in the Standard Configuration, but may also be customized by an authorized dealer. Unless otherwise specified, the buttons used in all of the instructions in this manual correspond to a Standard Configured transmitter.

→ standard configuration

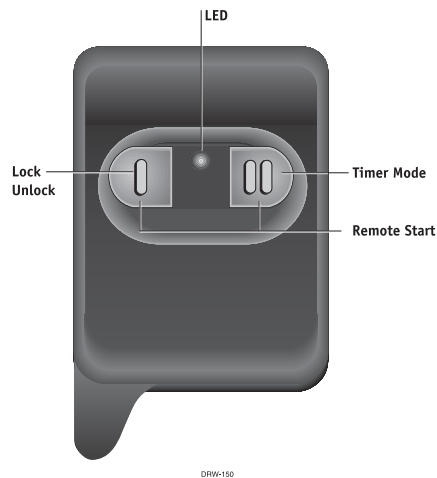

DRW150



Button I

The door locking and unlocking functions are controlled by pressing .

Button II

Timer Mode is controlled by .

Button I and II

The remote start function of your system is controlled by pressing  and  simultaneously.

transmitter/receiver learn routine

The system comes with one transmitter that has been taught to the receiver. The receiver can store up to 4 different transmitter codes in memory. Use the following learn routine to add transmitters to the system or to change button assignments if desired.

The Program switch, plugged into the blue port, is used for programming. There is a basic sequence of steps to remember whenever programming this unit: Key, Choose, Transmit and Release.



1. **Key.** Turn the ignition to the ON position.



2. **Choose.** Within 10 seconds, press and release the Program switch the number of times corresponding to the desired channel listed below. Once you have selected the channel, press the switch once more and hold it. The LED will flash to confirm the selected channel. Do not release the Program switch.

Channel number	Function
1	Lock/Unlock
2	Timer Mode
3	Remote Start



3. **Transmit.** While holding the Program switch, press the button on the transmitter that you would like to control the selected receiver channel.



4. **Release.** Once the code is learned, the Program switch can be released.

You can advance from programming one channel to another by releasing the Program switch and tapping it to advance steps and then holding it. For instance: You have programmed Channel One and you want to program Channel Two. Release the

Program switch. Press it one time and release it to advance from Channel One to Channel Two. Now, press and hold the Program switch. The LED will flash two times. As before, do not release it.

If you want to program Channel Three after programming Channel One, release the Program switch, press it twice and release it to advance to Channel Three. Then press it once more and hold it. The LED will flash three times to confirm it is ready to receive the code from the transmitter.

Learn Routine will be exited if:

- Ignition is turned off.
- Program switch is pressed too many times.
- More than 25 seconds elapses between programming steps.

using your system

→ **locking/arming**

Pressing  for one second will lock the doors. The parking lights will flash once to confirm that the doors are locked.

note: Power door lock control is an optional feature. Extra parts and labor may be necessary for your system to interface with your vehicle's power door locks.

→ **unlocking/disarming**

To unlock the doors press  for one second. The parking lights will flash twice to confirm that the doors are unlocked.

→ **ignition-controlled door locks**

If power door locks have been connected to your system and the ignition-controlled door locks are programmed on, the vehicle's door will lock three seconds after the ignition has been turned on and unlock when the ignition is turned off.



note: If the ignition is turned on while the vehicle is remote started the doors will not lock until the remote start shuts off. To avoid being locked out of the vehicle, do not turn the ignition on until you are ready to drive the vehicle.

→ **remote start**

This feature allows you to remotely start and run your vehicle for a programmable period of time. This makes it possible to warm up the engine, as well as adjust the interior temperature of the vehicle with the climate control system. If interior heating or cooling is desired, the climate controls must be preset, and the fan blower must be set to the desired level prior to remote starting the vehicle.

important! (1) Never remotely start the vehicle with the vehicle in gear, and (2) Never remotely start the vehicle with the key in the ignition.

To remote start the vehicle:



1. Simultaneously press  and  on the transmitter for one second.
2. The parking lights will flash to confirm remote start operation.
3. Once the vehicle has started, it will run for the pre-programmed period of time (12 or 24 minutes) or until a shutdown input is triggered.

When you are ready to drive the vehicle:



1. Insert the ignition key and turn it to the ON position.
2. Press the brake pedal.

note: If the brake pedal is pressed before the key is in the ON position, the engine will shut down.

While the vehicle is running during remote start operation, the system will monitor the vehicle and will automatically shut down the engine if the system receives any of the following shutdown inputs:

- The brake pedal is pressed.
- The hood is opened.
- The shutdown toggle switch is put into the ON position.
- The pre-programmed run time has elapsed.
- Buttons  and  are pressed again.

To shut down the remote start and turn off the engine:





- Step on the brake pedal, or
- Press  and  for one second.

→ timer mode



Timer Mode automatically starts the engine and runs it for a pre-programmed time period, every three hours for a total of six operation cycles. This feature helps to ensure that your engine will start in the morning after a night of extremely cold temperatures.

important! This feature must only be used in open areas, never in an enclosed area such as a garage.

To enter Timer Mode:





1. Start the vehicle by pressing and releasing  and .
2. Press and release .
3. Within two seconds press and release  and  again.

The engine will shut down and the parking lights will flash four times. The engine will then restart to confirm that Timer Mode has been entered.

The engine may be allowed to run for its preset time or can be shut down by pressing Buttons  and  again. Either way, it will restart every three hours for a total of six cycles. If the unit receives a shutdown input while operating in the timer mode the engine will stop, but will restart, on schedule, again in three hours.

To exit Timer Mode:



Timer Mode can be exited by turning the ignition on with the key any time the engine is not running. You can also exit Timer Mode manually from the transmitter by following these steps:

1. Start the engine by pressing  and .
2. Press and release .
3. Within two seconds press and release  and  again.
4. The engine will shut down and the parking lights will flash four times to confirm that Timer Mode has been exited. If the car has already been remote started, skip Step One.

→ valet take-over

The Valet® Take-Over feature allows the vehicle to remain running after the key has been removed from the ignition. This feature is useful for occasions when you wish to exit and lock the vehicle for short periods of time, but would like to leave the motor running and the climate controls on.

To perform Valet Take-Over:

1. Before turning off the engine, press and release  and  on the transmitter.
2. Turn the ignition key to the OFF position. The engine will stay running.
3. The engine will run until the pre-programmed time elapses or a shut-down input is received. (See the previous Remote Start section for a complete list of shut-down inputs.)

note: This feature will not work if the brake pedal is being pressed.

features menu

The factory settings are indicated in bold text in the table below.

Feature Number	LED On Setting (press channel 1)	LED Off Setting (press channel 2)
1	Engine checking on	Engine checking off
2	Tachometer checking type	Voltage checking type
3	12 minutes run time (1)	24 minutes (2) run time
4	Flashing parking light output	Constant parking light output
5	Cranking time 0.6 sec. (1)	Cranking time 0.8 (2), 1.0 (3), 1.2 (4), 1.4 (5), 1.6 (6), 1.8 (7), 2.0 (8), 4.0 (9) sec.
6	High voltage check level	Low voltage check level
7	Auxiliary output: factory alarm disarm	Auxiliary output: special accessory
8	Normal status output	Factory re-arm output
10	Ignition-controlled locking on	Ignition-controlled locking off
11	Ignition-controlled unlocking on	Ignition-controlled unlocking off

note: The number in parentheses indicate the number of times the LED will flash.

rapid resume logic

This Directed system will store its current state to non-volatile memory. If power is lost and then reconnected, the system will recall the stored state from memory. This applies to all states of the system including arm, disarm, and panic mode.

programming options

Programming options control your system's normal, operational set-up. Most options do not require additional parts, but some may require additional installation labor. Please contact your local retail dealer.

troubleshooting

- The ignition comes on, but the starter will not crank.
Does it start with the key in the ignition? If so, does the vehicle have an engine immobilizer?
Will it start with the brake pedal depressed? (Make sure to disconnect the brake shutdown when performing this test.)
If so, it may have a brake/starter interlock.
Is the correct starter wire being energized? Check by energizing it yourself with a fused test lead.

- The starter cranks for six seconds but does not start.
Either the wrong ignition wire is being energized, the system's ignition and accessory wires have been connected backwards, or the vehicle has two ignition circuits. Try activating the unit with the ignition key in the "run" position. If the vehicle then runs normally, retest your ignition system.
- The starter continues to crank even though the engine has started.
Has the tach wire been learned? See the Tach Learning section of this guide.
Is the tach wire receiving the correct information? Either the wrong tach wire has been used, or a bad connection exists.
- The climate control system does not work while the unit is operating the vehicle.
Either the wrong accessory wire is being energized or more than one ignition or accessory wire must be energized in order to operate the climate control system.
- The remote start will not activate.
Check harnesses and connections. Make sure the harnesses are fully plugged into the remote start module. Make sure there are good connections to the vehicle wiring.
Check voltage and fuses. Use a meter and check for voltage between the red wire in the 5 pin ribbon harness and the black ground wire. If you have less than battery voltage,

check the 3A and both 30A fuses on the relay satellite. Also make sure that the ground wire is going to a chassis ground and not to something under the dash.

- The remote start will activate but the starter never engages. Check for voltage on the purple starter wire two seconds after the remote start becomes active. If there is voltage present, skip to Step 4. If there is not voltage present, advance to Step 2.

Check the 30A fuses.

Make sure the purple starter wire is connected on the starter side of the optional starter kill relay.

Does the vehicle have an immobilizer? Some immobilizer systems will not allow the vehicle to crank if active.

Check connections. The two red heavy gauge input wires on the relay satellite should have solid connections. "T-taps", or "scotch locks" are not recommended for any high current heavy gauge wiring. Also, if the vehicle has more than one 12-volt input wire, then connect one red wire to each.

- The vehicle starts, but immediately dies. Does the vehicle have an immobilizer? The vehicle's immobilizer will cut the fuel and/or spark during unauthorized starting attempts.

Is the remote start programmed for voltage sense? If so, the start time may not be set high enough, or you may have to adjust the voltage threshold in programming. Voltage sense will not work on some vehicles.

- The vehicle starts, but the starter keeps running.

Is the system programmed for engine checking off or voltage sense? When programmed for either of these features, the engine cranks for the preprogrammed crank time regardless of how long it takes to start the vehicle to actually start. Adjust to a lower cranking time.

Was the Tach Learn successful? The LED must light solidly and brightly to indicate a successful learn.

Make sure that there is a tach signal right at the purple/white tach input wire of the remote start. If not, recheck the connection to the vehicle's tach wire and make sure the wire is not broken or shorted to ground leading to the remote start.

- The vehicle will start and run only for about 10 seconds.

Is the remote start programmed for voltage sense? Try programming the unit for low voltage reference. If this does not work, a tach wire should be used.

glossary of terms

Control Unit: The “brain” of your system. Usually hidden under the dash area of the vehicle. It houses the microprocessor that monitors your vehicle and controls all system functions.

LED: A red light mounted at a discretionary location inside the vehicle. It is used to indicate the status of your system.

Transmitter: A hand-held, remote control which operates the various functions of your system.

Valet Switch: A small button mounted at a discretionary location inside the vehicle. It is used to override the starter interrupt when a transmitter is lost or damaged, or to enter or exit Valet Mode.

security & convenience expansions

Listed below are some of the many expansion options available for use with your system. Some options may require additional parts and/or labor. Please consult with your dealer for a complete list of options available for use with this system.

Power Door Lock Control: Your system is capable of controlling many types of power door lock systems; however, some door lock systems may require extra parts. Consult with your dealer to determine which type of locks your vehicle uses. If power locks are connected, the system can be programmed to lock the doors automatically 30 seconds after the ignition has been turned off. The system can also be programmed to lock the doors when the ignition is turned on and to unlock them when the ignition is turned off.

wiring quick reference guide

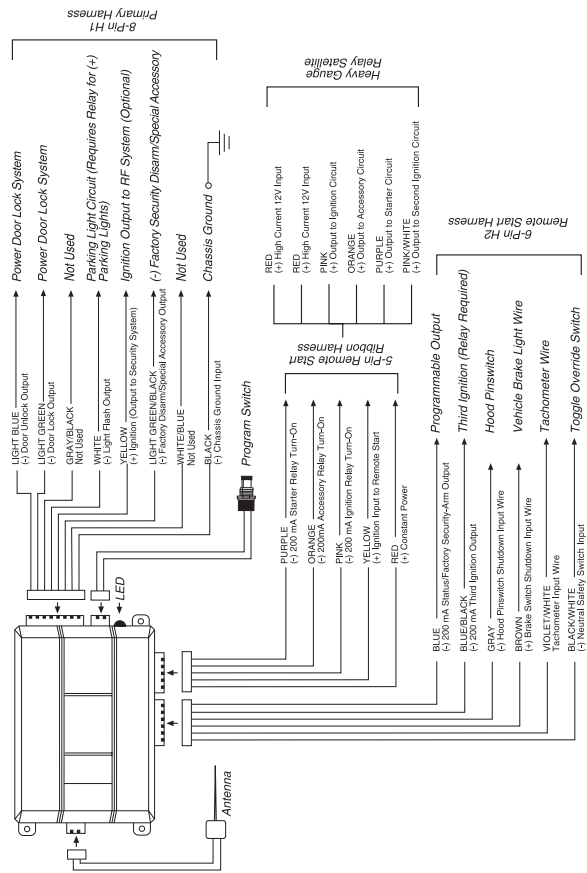

Cut along dotted line and fold for a quick and easy reference to keep in your purse or wallet.

QUICK REFERENCE GUIDE:



To lock the doors using your remote

- Pressing  for one second will lock the doors. The parking lights will flash once to confirm the doors are locked. **NOTE:** Control of power door locks is optional. Extra parts and labor may be necessary to interface with power door locks.

To unlock the doors using your remote

- To unlock the doors, press  for one second. The parking lights will flash twice to confirm the doors are unlocked.

To remote start the vehicle

- Press  and  on the transmitter for one second. The parking lights will flash to confirm remote start operation. Once the remote start has been activated, the vehicle will run for the preprogrammed period or until a shutdown input is triggered.

QUICK REFERENCE GUIDE:



To lock the doors using your remote

- Pressing  for one second will lock the doors. The parking lights will flash once to confirm the doors are locked. **NOTE:** Control of power door locks is optional. Extra parts and labor may be necessary to interface with power door locks.

To unlock the doors using your remote

- To unlock the doors, press  for one second. The parking lights will flash twice to confirm the doors are unlocked.

To remote start the vehicle

- Press  and  on the transmitter for one second. The parking lights will flash to confirm remote start operation. Once the remote start has been activated, the vehicle will run for the preprogrammed period or until a shutdown input is triggered.

The company behind this system is Directed Electronics, Inc.

Since its inception, Directed Electronics has had one purpose, to provide consumers with the finest vehicle security and car stereo products and accessories available. The recipient of nearly 100 patents and Innovations Awards in the field of advanced electronic technology, DIRECTED is ISO 9001 registered.

Quality Directed Electronics products are sold and serviced throughout North America and around the world.

Call **(800) 274-0200** for more information about our products and services.



DEI is an ISO 9001 registered company.

Directed Electronics is committed to delivering world class quality products and services that excite and delight our customers.



Directed Electronics, Inc.
Vista, CA 92083
www.directed.com

© 2002 Directed Electronics, Inc. - All rights reserved
G259R 8-02

Free Manuals Download Website

<http://myh66.com>

<http://usermanuals.us>

<http://www.somanuals.com>

<http://www.4manuals.cc>

<http://www.manual-lib.com>

<http://www.404manual.com>

<http://www.luxmanual.com>

<http://aubethermostatmanual.com>

Golf course search by state

<http://golfingnear.com>

Email search by domain

<http://emailbydomain.com>

Auto manuals search

<http://auto.somanuals.com>

TV manuals search

<http://tv.somanuals.com>