

Directed[®]
VIDEO

OWNER'S GUIDE
INSTALLATION GUIDE



15" Widescreen Overhead Video Monitor

MODEL OHV1500

© 2004 Directed Electronics, Inc. N81150 08-04

Table of Contents

Non-Transferable Limited Consumer Warranty3
Important Notes4
What is Included5
Introduction5
Installation6
Preliminary Preparations6
Electrical Connections7
Typical Wiring Diagram8
OHV Monitor Controls and Description9
Remote Control10
Battery Replacement11
Operation11
Open—LCD Screen11
Close—LCD Screen11
Signal Source Selection12
ON/OFF Control12
Function Mode (Menu)12
Door Light On/Off12
Specifications14
System Configurations15

NON-TRANSFERABLE LIMITED CONSUMER WARRANTY

.....

Directed Electronics, Inc. (Directed) promises to the original purchaser that the automotive video monitor and/or source unit(s) (the Product), excluding accessories, purchased and installed from a Directed authorized dealer within the ninety (90) days after purchase of the new vehicle, in which the Product is installed, is free from defects in materials or workmanship under normal use and conditions for a period of three (3) years from date of purchase or the first 36,000 miles as registered on the new vehicle's odometer reading at time of delivery of the Product for warranty service, whichever occurs first. Product purchased or installed more than ninety (90) days after the new vehicle is purchased are warranted for a period of one (1) year from date of purchase of the Product.

Directed promises to the original purchaser that all video accessories will be free from defects in materials and workmanship under normal use and condition for a period of ninety (90) days after the date of purchase. A sales receipt and/or warranty registration card is required to provide proof of date of purchase of the Product or accessories.

Should the Product be determined defective during the applicable warranty period, the Product will be repaired or replaced with a new or comparable reconditioned part(s), at Directed's option. To obtain warranty service, the Product must be returned to a Directed authorized dealer along with proof of purchase and installation.

Note: This warranty does not cover labor costs for the removal and reinstallation of the Product. IN ORDER FOR THIS WARRANTY TO BE VALID, YOUR PRODUCT MUST BE SHIPPED WITH PROOF OF PURCHASE AND INSTALLATION BY AN AUTHORIZED DIRECTED DEALER. ALL PRODUCTS RECEIVED BY DIRECTED FOR WARRANTY REPAIR WITHOUT PROOF OF DIRECTED DEALER INSTALLATION WILL BE DENIED.

This warranty is non-transferable and does not apply to any Product that has been modified or used in a manner contrary to its intended purpose, and does not cover damage to the Product caused by installation or removal of the Product. This warranty is **VOID** if the product has been damaged by accident or unreasonable use, negligence, acts of God, neglect, improper service or other causes not arising out of defect in materials or construction. This warranty does not cover the elimination of externally generated static or noise, or the correction of antenna problems or weak television reception, damage to tapes, video games, software, camcorders, discs, speakers, accessories or vehicle electrical systems, cosmetic damage or damage due to negligence, misuse, abuse, failure to follow operating instructions, accidental spills or customer applied cleaners, damage due to environmental causes such as floods, airborne fallout, chemicals, salt, hail, windstorms, lightning or extreme temperatures, damage due to accidents, road hazards, fire, theft, loss or vandalism, damage due to improper connection to equipment of another manufacturer, modification of existing equipment, use of a faulty tape cartridge or cleaning of the VCR head, or Product which has been opened or tampered with for any reason or which has been damaged due to alteration or service performed by anyone other than Directed Electronics, Inc.

ALL WARRANTIES INCLUDING BUT NOT LIMITED TO EXPRESS WARRANTY, IMPLIED WARRANTY, WARRANTY OF MERCHANTABILITY, FITNESS FOR PARTICULAR PURPOSE, AND WARRANTY OF NON-INFRINGEMENT OF INTELLECTUAL PROPERTY ARE EXPRESSLY EXCLUDED TO THE MAXIMUM EXTENT ALLOWED BY LAW, AND DIRECTED NEITHER ASSUMES NOR AUTHORIZES ANY PERSON TO ASSUME FOR IT ANY LIABILITY IN CONNECTION WITH THE SALE OF THE PRODUCT. DIRECTED HAS ABSOLUTELY NO LIABILITY FOR ANY AND ALL ACTS OF THIRD PARTIES INCLUDING ITS LICENSED DEALERS OR INSTALLERS. IN NO EVENT WILL DIRECTED ELECTRONICS, INC. BE LIABLE FOR ANY INCIDENTAL, SPECIAL OR CONSEQUENTIAL DAMAGES (INCLUDING LOSS OF PROFITS), BY PURCHASING THIS PRODUCT, THE CONSUMER AGREES AND CONSENTS THAT ALL DISPUTES BETWEEN THE CONSUMER AND DIRECTED SHALL BE RESOLVED IN ACCORDANCE WITH CALIFORNIA LAWS IN SAN DIEGO COUNTY, CALIFORNIA.

Some states do not allow limitation on how long an implied warranty lasts. In such states, the limitations or exclusions of this Limited Warranty may not apply. Some states do not allow the exclusion or limitation of incidental or consequential damages. In such states, the exclusion or limitation of this Limited Warranty may not apply to you. This Limited Warranty gives you specific legal rights, and you may have other rights which vary from state to state.

Some states do not allow the exclusion or limitation of incidental or consequential damages. In such states, the exclusion or limitations of this Limited Warranty may not apply to you. This Limited Warranty gives you specific legal rights and you may have other rights which vary from state to state.

Important Notes

1. Before operating your LCD Monitor system, please read these instructions carefully.
2. Retain this manual for future reference.
3. Do not remove any WARNING stickers on the unit.
4. Do not use any chemical solvent, cleaning agent or corrosive detergent to clean away dirt on the surface of the screen. Doing so may cause irreversible damage to the surface of the LCD screen. To clean off dirt or fingerprints, it is recommended that a soft-damp lens-cleaning cloth be used.
5. Using spare parts from another manufacturer may cause permanent damage to the unit.
6. Avoid installing the monitor screen in a position that is exposed to direct sunlight and hot air vents.
7. Install the unit in a dry location, avoid condensation.
8. Ensure that all wiring is properly connected before operating the unit.
9. Should the LCD panel break, avoid contact with the broken glass or fluid leaking out from the enclosure. If you come into contact, flush and clean the affected areas with plenty of water. Seek medical attention immediately.
10. When operating the monitor, avoid touching or pressing on the LCD screen. Excessive force will damage the LCD screen.
11. When installing this unit in a vehicle, ensure that the installation and use of this unit is in compliance with local vehicle rules and regulations.
12. Before replacing a blown fuse, turn the unit off and disconnect all power. Ensure the replacement fuse is of the same rating (5A) of the fuse being replaced.
13. If during operation the unit overheats or malfunctions, turn off the power and contact your dealer. Do NOT disassemble the unit, there are no user serviceable parts in the unit.
14. Ensure that no foreign objects are in the unit when the LCD screen is closed.
15. The battery (CR2025) in the remote control has a useful lifetime of approximately 6-months. To ensure proper and reliable operation, replace the battery in a timely manner.
16. When the unit is used in conjunction with a radio/TV tuner, reception quality will vary depending on the geographic location and weather conditions.
17. The rated operating temperature range of the unit is 32°–92° F. Cool or warm the vehicle to within this temperature range prior to unit operation.
18. The picture viewing quality of this LCD is dependent on the installed location. Adjust the brightness control and/or the angle of the screen to achieve the optimum visual quality.

What is Included

- 15" Overhead Monitor
- Trim Ring Adapter
- AV Switch Box (AD-6874)
- Remote Control Unit/battery
- 4-pin, 3-wire power harness
- 5-pin 5-wire dome lights harness
- 13-pin DIN source cable
- Hardware package
- Metal mounting plate

Introduction

Congratulations on your purchase of the world's finest video entertainment system. At Directed we are committed to bringing you the most technologically advanced products available. We are pleased that you chose a Directed Video product. Through years of critical testing and hand craftsmanship, we have created a wide range of video entertainment products for your viewing pleasure.

The 15" Widescreen Overhead Video Monitor can provides all the functions of a television as well as the functionality of a DVD player for your viewing pleasure in the car, truck, or in your RV.

This system incorporates the use of on screen display menu controls that allows you to configure the system to suit your own personal preferences. For your listening flexibility, audio can be heard by optional infrared (wireless) headphones.

To view other great products from Directed Electronics, please visit the Directed Video page at www.directed.com.

Installation

PRELIMINARY PREPARATIONS

NOTE: *The unit should be installed by a qualified service technician. This unit is designed to operate with a 12 VDC, negative ground battery system.*

NOTE: *Use only proper sized fasteners and cables during installation. Use of improper fasteners or cables can lead to mechanical failure of the unit or create a fire hazard.*

1. Disconnect the ground wire from the battery terminal prior to connecting the unit to the electrical system.

NOTE: *Some vehicle radios have an anti-theft code system that will disable the radio if the battery is disconnected. If this vehicle has such a radio, ensure you have the access code to restore the radio to normal operation.*

2. Pick a location to install the monitor where it will not obstruct the rear view mirror or the air conditioning vents.
3. Do not install this unit at an angle exceeding 30 degrees.

ELECTRICAL CONNECTIONS

Main Power Harness

Color	Description
Black	Chassis ground
Yellow	+12V Battery
Red	+12V ACC

Courtesy Light Harness

Color	Description
Black	Chassis ground
Red	+12V ACC
Gray	Door (negative trigger)
Purple	Door (positive trigger)
Yellow	+12V Battery

Audio Connections



Color	Description
Red IN 1 (RCA)	Audio - #1 Right Input
White IN 1 (RCA)	Audio - #1 Left Input
Red IN 2 (RCA)	Audio - #2 Right Input
White IN 2 (RCA)	Audio - #2 Left Input
Red OUT (RCA)	Audio - Right Output
White OUT (RCA)	Audio - Left Output

Video Connections

Color	Description
Yellow 1 (RCA)	Video - #1 Input
Yellow 2 (RCA)	Video - #2 Input
Yellow OUT (RCA)	Video - Output

OHV Monitor Controls and Description



- | | |
|---|---|
| 1. LCD display | 6. Standby LED |
| 2. UP/DOWN button | 7. Door light On/Off button () |
| 3. MENU button | 8. Courtesy Light () |
| 4. ON/OFF/MODE button () | 9. IR transmitter (optional headphones) |
| 5. Remote sensor | 10. Open button |

Remote Control

NOTE: Ensure that the battery plastic protector has been removed from the remote control battery holder prior to use.

The frequently used buttons are described below.

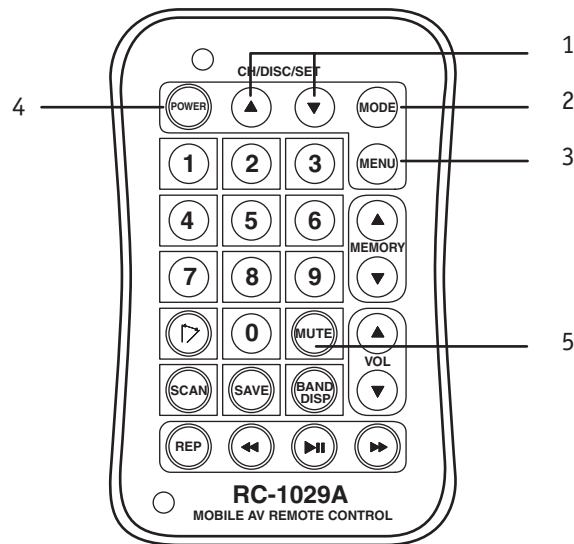

1. CH/DISC/SET (▲/▼)—use these buttons to search for a TV channel, select DVD title, or to select setting(s) from MENU screen.
2. MODE—press this button to select the video source (AV1/AV2).
3. MENU—press this button to display the MENU screen.
4. POWER—press this button to turn power on or off to the unit.
5. MUTE—press this button to mute the audio, press again to restore the audio.

Battery Replacement

1. Follow the instructions given in the illustration below to open the battery holder.
2. Remove the old battery and replace it with a CR2025 or equivalent. The positive (+) side of the battery must be facing upward in the clip.
3. Push the battery holder into the body of the remote control until the battery holder is locked.
4. Properly dispose of the old battery.

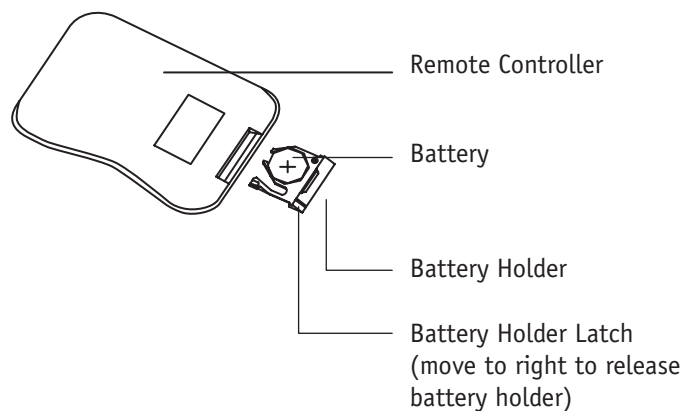

Operation

NOTE: Some functions are operational only when the LCD monitor is connected as an integrated system to other audio/visual peripherals; such as, radio tuner, TV tuner, VCD/DVD/CD player.

OPEN—LCD SCREEN

To open the LCD screen press the OPEN/CLOSE button and carefully rotate the LCD screen down to its operating position.

CLOSE—LCD SCREEN

To close the LCD screen rotate the LCD screen up to its stored position until you hear the OPEN/CLOSE button click.

SIGNAL SOURCE SELECTION

Select the input signal for viewing (AV1 or AV2) by momentarily pressing the () button on the LCD screen or the MODE button on the remote.

ON/OFF CONTROL

Press and hold the () button on the LCD screen or press the POWER button on the remote.

FUNCTION MODE (MENU)

Press the MENU button on either the LCD screen or the remote to display the following setup options:

- COLOR
- BRIGHT
- TINT
- SHARPNESS
- CONTRAST
- DIMMER
- FORMAT (Normal, Full, Zoom)
- RESET (restore factory default settings)

Once the desired setting is selected use the cursor buttons to change the setting. After 5-seconds of inactivity the MENU screen will turn off.

DOOR LIGHT ON/OFF

Press this switch on the LCD screen to have the door open sensor operate the dome lights.

NOTE: *This feature is operational only if the Gray or Purple door lock trigger wires have been connected to the door sensor.*

The dome light selector switch contains two separate circuits. One for a positive dome light trigger and one for a negative dome light trigger. Please refer to the wiring table below for each of these triggers.

NEGATIVE DOME LIGHT TRIGGER

WIRE COLOR	CONNECTION
Gray	Battery ground
Blue	Battery +12VDC
Orange	Battery +12VDC
Purple	Negative door trigger

POSITIVE DOME LIGHT TRIGGER

WIRE COLOR	CONNECTION
Gray	Battery +12VDC
Blue	Battery ground
Orange	Battery ground
Purple	Positive door trigger

COURTESY LIGHT ON/OFF

Press the Courtesy light switch () on the LCD screen to illuminate the dome light.

Specifications

Type	Roof mount color display monitor
Display system	15.2-inch active matrix color TFT LCD NTSC/PAL auto switch
Display format	409,920 pixels
Aspect ratio	16:9
Resolution	854 (W) X 480 (H) X 3 RGB
Active area	335.6 (W) X 188.6 (H) mm
Back light	10,000 hours normal operation
Mechanism	Manual open/close
Display angle	Adjustable Horizontal: Up/Down <110°
Source	Composite video input x 2 Composite video output x 2 Audio L/R input x 1
Wireless audio	Infrared audio transmitter (support IR receiver stereo headphone, L-channel 2.3 MHz/R-channel 2.8 MHz) Effective listening angle: 30° Effective range: 4 meters
Dome light	5W X 2 with door sensor connection
Operating voltage	12 VDC
Operating current	2.3 A, typical
Operating temperature	0° to 60°C

NOTE: All specifications are subject to change without notice.

System Configurations

OPTION 1

Color Monitor/One Din DVD Player Digital Sound Processor Unit

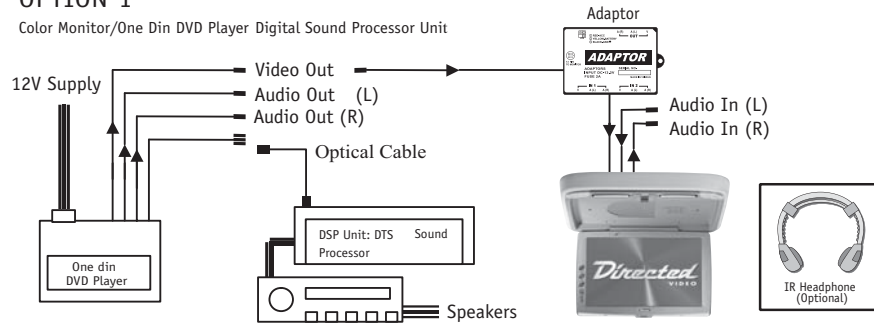

OPTION 2

Color Monitor/TV/Radio Tuner Amplifier / One Din DVD Player

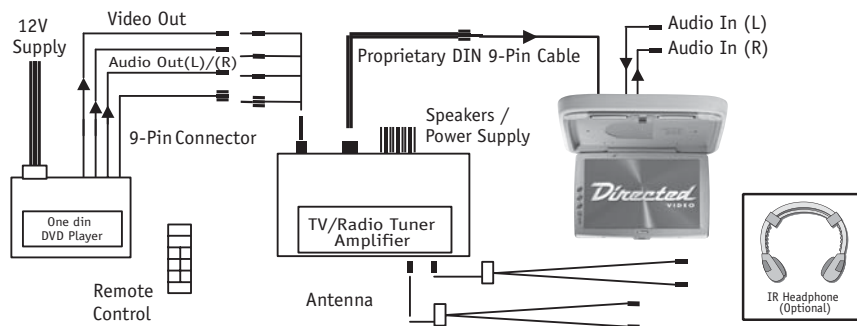

OPTION 3

Color Monitor/One Din DVD Player / Pre-Amp / Power Amplifier

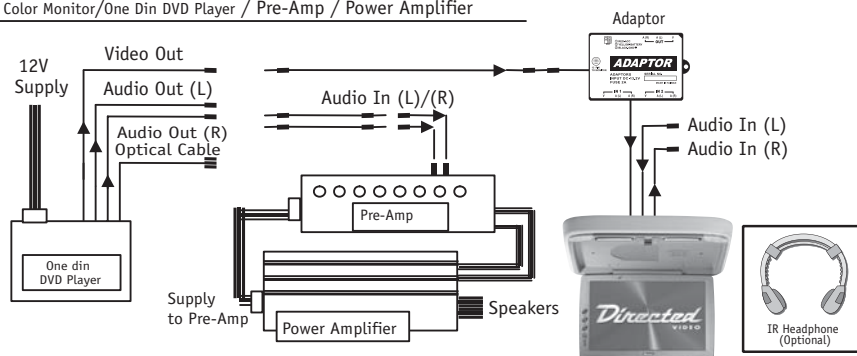

The company behind this system is Directed Electronics, Inc.

Since its inception, Directed has had one purpose, to provide consumers with the finest vehicle security, car stereo products, rear seat entertainment, and accessories available. The recipient of more than 20 patents in the field of advanced electronic technology, Directed is ISO 9001 registered.

Quality Directed Electronics products are sold and serviced throughout North America and around the world.

Call **(800) 274-0200** for more information about our products and services.



DEI is an ISO 9001 registered company.

Directed* is committed to delivering world-class quality products
and services that excite and delight our customers.



Directed Electronics, Inc.
Vista, CA 92081
www.directed.com

© 2004 Directed Electronics, Inc.—All rights reserved
N81150 08-04

Free Manuals Download Website

<http://myh66.com>

<http://usermanuals.us>

<http://www.somanuals.com>

<http://www.4manuals.cc>

<http://www.manual-lib.com>

<http://www.404manual.com>

<http://www.luxmanual.com>

<http://aubethermostatmanual.com>

Golf course search by state

<http://golfingnear.com>

Email search by domain

<http://emailbydomain.com>

Auto manuals search

<http://auto.somanuals.com>

TV manuals search

<http://tv.somanuals.com>