

Contents

Safety Instructions	v
Chapter 1 - How to Get Started	1
Welcome!	1
Overview	2
New Features Video	2
Getting Started	3
Quick Tour of Basic Features	4
Quick Tour of the Menus	6
Quick Tour of DishDVR Features	10
Chapter 2 - Parts of the System	15
The Receiver	15
Remote Control	20
Receiver Menus	27
TV and VCR Connections	29
Chapter 3 - Using the System.....	31
Change Channels	31
Use the Program Guide	31
Use the Program Banner	34
Use the Browse Banner	34
Buy a Pay Per View Program	36
Use Themes	37
Use Favorites Lists	38
Use the Search Feature	40
Use Locks	42
Use Event Timers	48
Use Caller ID	58
Use Dolby® Digital Sound	59
Use the DishDVR Features	60
Control Other Devices with the Remote	68
Upgrade the Receiver Software	79
Reset the Receiver	80
Change Program Languages	80
Set Up the Accessory Jack	81
Dish Home Interactive TV Applications	81

Chapter 4 - Installation Instructions	83
How to Use these Instructions	83
Installing a DISH 500 Antenna	83
DishPro Wiring Diagrams	94
Running Coaxial Cable	101
Connecting Each Receiver to a Phone Line	102
Chapter 5 - Reference.....	105
Use the Troubleshooting Tables	105
Test the System	119
Device Codes	120
Appendix A.....	125
Appendix B.....	127
Limited Warranty	127
What the Warranty Covers	127
What the Warranty Does Not Cover	127
Residential Customer Agreement	130
Staying Legal	136
FCC Compliance	137
Radio Interference	138
Index	139

Important Safety Instructions

1. Read these instructions.
2. Keep these instructions.
3. Heed all warnings.
4. Follow all instructions.
5. Do not use this apparatus near water.
6. Clean only with a dry cloth.
7. Do not block any ventilation openings. Install in accordance with the manufacturer's instructions.
8. Do not install near any heat sources such as radiators, heat registers, stoves, or other apparatus (including amplifiers) that produce heat.
9. Do not defeat the safety purpose of the polarized or grounding-type plug. A polarized plug has two blades with one wider than the other. A grounding-type plug has two blades and a third grounding prong. The wide blade or the third prong are provided for your safety. If the provided plug does not fit into your outlet, consult an electrician for replacement of the obsolete outlet.
10. Protect the power cord from being walked on or pinched, particularly at plugs, convenience receptacles, and the point where they exit from the apparatus.
11. Use only attachments/accessories specified by the manufacturer.
12. Unplug this apparatus during lightning storms or when unused for long periods of time.
13. Refer all servicing to qualified service personnel. Servicing is required when the apparatus has been damaged in any way, such as the power supply cord or plug is damaged, liquid has been spilled or objects have fallen into the apparatus, the apparatus has been exposed to rain or moisture, does not operate normally, or has been dropped.



Apparatus shall not be exposed to dripping or splashing and no objects filled with liquids, such as vases, shall be placed on the apparatus.

Note to Satellite TV System Installer: This reminder is provided to call the satellite TV system installer's attention to Article 820-40 of the *National Electrical Code* (NEC) that provides guidelines for proper grounding and, in particular, specifies that the cable ground shall be connected to the grounding system of the building as close to the point of cable entry as practical.

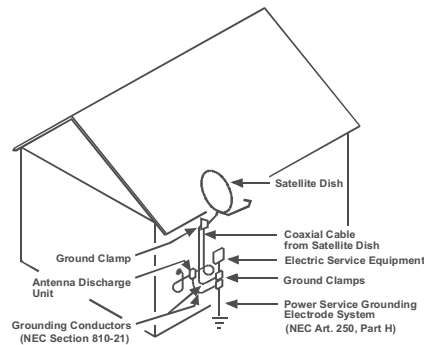

Safety Tips

- Unplug the receiver from the AC power outlet *before* cleaning.
- The use of accessories or attachments not recommended by the receiver manufacturer will void the *Limited Warranty*.
- Do *not* place the receiver in an enclosure such as a cabinet without proper ventilation.
- Do not install the receiver in any area where the temperature can be less than 40°F or more than 113°F.
- Do *not* stack the receiver on top of or below other electronic devices.
- Do *not* place candles or other meltable objects on top of the receiver.
- Operate the receiver using *only* the type of power source indicated on the marking label. Unplug the receiver power cord by gripping the power plug, *not* the cord.
- Do *not* overload wall outlets or extension cords, as this can result in a risk of fire or electrical shock.
- *Never* insert objects of any kind into the receiver through openings, as the objects may touch dangerous voltage points or short out parts. This could cause fire or electrical shock.
- *Make sure* that the outdoor parts of the antenna system are grounded in accordance with local, state, federal, and *National Electrical Code* (NEC) requirements.
- Do *not* locate the antenna near overhead light or power circuits, or where it can fall into such power lines or circuits. When installing the antenna, take *extreme* care to avoid touching such power lines or circuits, as contact with them can be *fatal*.
- Do *not* attempt to service the receiver yourself, as opening or removing covers may expose you to dangerous voltage, and will void the *Limited Warranty*. Refer all servicing to authorized service personnel.
- Use an outlet that contains surge suppression or ground fault protection. For added protection during a lightning storm, or when the receiver is left unattended and unused for long periods of time, unplug the power cord from the wall outlet, disconnect the lines between the receiver and the antenna, and disconnect the telephone line. This will provide some protection against damage caused by lightning or power line surges.

Chapter 1

How to Get Started

Welcome!

You're about to enjoy a Digital Video Recorder!

This satellite receiver lets you decide how you watch TV. You can record and play back audio and video with full digital quality. You can pause a live program and not miss any of the action or you can record a program to watch later, without a VCR.

This device is also an advanced satellite receiver, with features like a UHF/IR remote control, on-screen program information, themes to select programs, favorite lists, program locks, Dolby® Digital sound, and more.

IMPORTANT INFORMATION ABOUT THIS RECEIVER

- Always handle the satellite receiver carefully. Avoid excessive shock and vibration at all times as this can damage the hard drive.
- If you have the receiver turned on and need to move it, be sure to unplug the receiver and *let it sit for at least 30 seconds* before moving it.
- Do not install the receiver in any area where the temperature can be less than 40°F or more than 113°F while the unit is operating.
- If the receiver is cold to the touch, do not plug it in immediately. Let it sit *unplugged* at room temperature for at least 45 minutes before plugging it in.
- Avoid installing the receiver on top of or underneath another electronic device (such as a stereo receiver) as this can cause heat build-up and vibration.

Note: Portions of your system may be marked with *DishPVR* and *PVR* or *DishDVR* and *DVR*. Either way, the system works just the same.

Welcome to this User Guide! We have placed tips in the gray bars on most pages to help you.

Tip: Notice that menus and other screen pictures shown in this guide are for example only. What you see on your TV may look a bit different.

Overview

Before you use your satellite receiver, you need to install the system or have it installed by a professional technician. For a professional installation, please call the Customer Service Center at 1-800-333-DISH (3474). If you install the system yourself, use the instructions in *Chapter 4*.



A vital part of the installation is to set up the receiver to get the latest software via the satellite signal. You cannot use the receiver's features until you do! If you are installing a new system and follow the instructions in *Chapter 4*, your receiver will automatically get this software.

- After you install your system (or add this receiver to an existing system), all you need to do is order your program packages using the instructions on page 3.
- Take the *Quick Tours* that begin on page 4 to become familiar with product operation and features.
- To learn about the parts of the system, see *Parts of the System* on page 15.
- To learn how to use the system, see *Chapter 3, How to Use the System* on page 31.
- To troubleshoot the system, see *Chapter 5, Reference* on page 105.
- Tune to the DISH Network info channels or visit our Web site at www.dishnetwork.com for info.
- For more help, call the Customer Service Center at 1-800-333-DISH (3474).

New Features Video

Your new receiver comes with *New Features Video* software. This new software allows us to download information to your hard drive in the form of short, video messages which will appear in your **DVR List**. We will use these messages to tell you when we've updated your receiver to add exciting new features and capabilities. Be sure to look for these events whenever you access your recorded events — to see what's new for you from the DISH Network!

Getting Started

Order Your Program Packages

1. Turn on the receiver and your TV.
2. Press the **SYS INFO** button on the receiver front panel to open the **Important System Information** screen on the TV screen. Leave the menu open while you do steps 3 and 4.

SYS INFO



Note: The numbers in the figure below are for example only. Use the numbers on the **Important System Information** screen displayed on your TV.



3. Call 1-800-333-DISH (3474) to tell us you've installed the system and want to get services. We'll explain what program packages you can buy. You'll need to verify the information on the **Important System Information** screen.
4. We'll turn your services on via the satellite signal. This process usually takes just a few minutes. When we finish, you'll be able to watch your programs.
5. Press the **SELECT** button on the remote control or receiver front panel to clear the **Important System Information** menu from the TV screen.



Chapter 1

How to Get Started

The Program Guide is your key to satellite TV programs. The receiver displays the Program Guide on the TV screen.

You'll find a quick tour of basic features here, and a quick tour of DVR features beginning on page 10.

Whenever you want to go back to the last channel you watched, just press the **RECALL** button.

Choose a Program to Watch

1. Make sure the receiver is on and its green front panel **POWER** light is on. *Also, make sure you turn on the TV.*
2. Press the remote control **GUIDE** button to open the receiver's **Program Guide** on the TV screen.



3. Use the remote control **ARROW** buttons to move the highlight around the **Program Guide**, and to highlight a program that is on *now*.
4. Press the remote control **SELECT** button to watch the program you just highlighted.

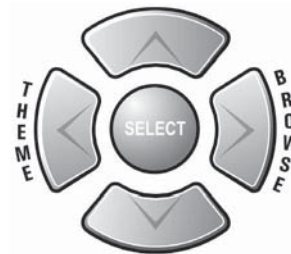

Quick Tour of Basic Features

1. Make sure the TV is on.
2. Press the **UP** or **DOWN ARROW** button to change channels.
3. Press the **RECALL** button to go back to the last channel you watched.



4. Press the **THEME** (LEFT arrow) button to open the **Themes** menu.



5. For example, press the 1 button to see a list of movies.



6. Press the **VIEW** button to go back to watch a program.



7. Press the **INFO** button to see info about the program.



8. Press the **CANCEL** button to go back to watch the program.



9. Press the **BROWSE** (RIGHT arrow) button to open the **Browse Banner**.

In this example, the **Browse Banner** shows info on a program we're watching at the top, and info on another program at the bottom.

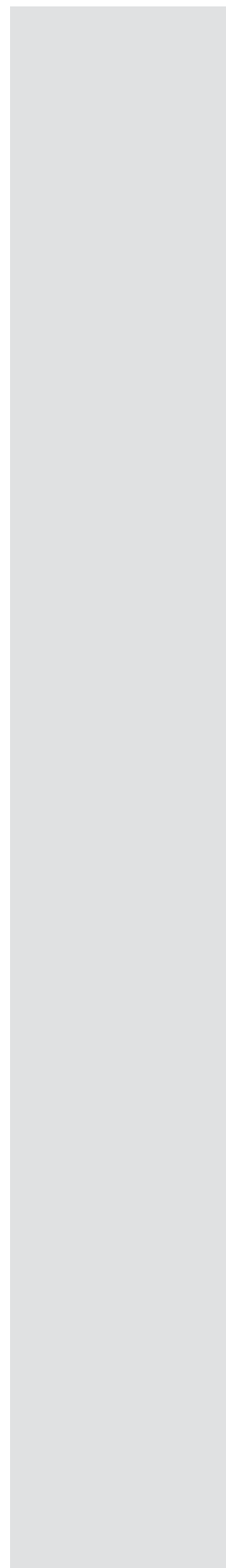

Chapter 1

How to Get Started

10. Press the UP or DOWN ARROW button to change the channel information you see at the bottom of the TV screen. Until you do, the bottom info is the same as the top info.



11. Press the RIGHT ARROW button to change the channel information you see at the bottom of the TV screen for the program coming next. Press the LEFT ARROW button to get back to the program on now.



12. Press the VIEW button to clear the **Browse Banner** from the TV screen and to go back to watching a program.



Quick Tour of the Menus

1. Press the remote control MENU button to open the **Main Menu**.

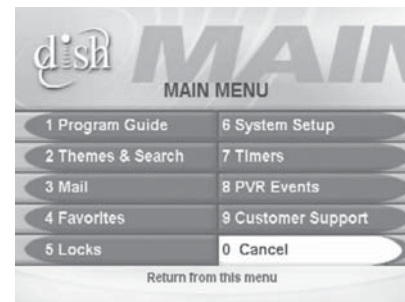

2. Press the 1 button to select the **Program Guide** option on the **Main Menu**. This opens the **Program Guide** on the TV screen.



You can use the **Program Guide** to find a program to watch. For now, though, go on with this tour.

Tip: The Main Menu is your key to the menus the receiver displays on the TV screen.



3. Press the MENU button to go back to the **Main Menu**.

MENU



4. Press the 2 button to select the **Themes and Search** option on the **Main Menu**. This opens the **Themes** menu on the TV screen.

abc



5. For example, press the 1 button to see a list of movies.



Any time you're in a menu and want to go directly back to watching your program, just press VIEW on the remote.

Tip: Themes let you get a list of just movies, just sports events, or just programs in several other categories.

Chapter 1

How to Get Started

Tip: You can set up a Favorites List of your favorite channels. Then, when you use this list as your program guide, you see only those channels that really interest you.

Tip: The System Setup menu lets you set up the system the way you want!

6. Press the **MENU** button to go back to the **Main Menu**.
7. Back on the **Main Menu**, notice the **Mail** option. The mail feature is for DISH Network to send you messages, and only at special times.
8. Press the **4** button to select the **Favorites** option on the **Main Menu** to open the **Favorite Lists** menu. You can use **Favorite Lists** to make the **Program Guide** and other on-screen lists show only your favorite channels.

MENU



ghi



9. Press **MENU** to go back to the **Main Menu**.
10. Press the **5** button to select the **Locks** option on the **Main Menu**. This opens the **Locks** menu on the TV screen. This menu is used to set a lock.

MENU



jkl



11. Press **MENU** to go back to the **Main Menu**.
12. Press the **6** button to select the **System Setup** option on the **Main Menu**. This opens the **System Setup** menu.

MENU



mno



Use this menu to set up the system the way you want.



13. Press MENU to go back to the **Main Menu**.
14. Press the 7 button to select the **Timers** option on the **Main Menu** to open the **Event Timer Management** menu.

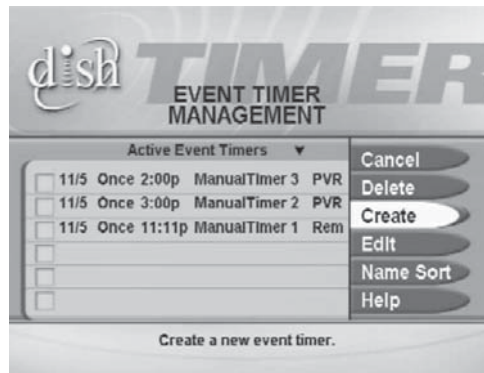

This menu is used for creating and changing timers used to trigger automatic recordings.

15. Press MENU to go back to the **Main Menu**.
Note: Your screen may show *PVR* instead of *DVR*, but the receiver operates the same way.
16. Press the 8 button to select the **DVR Events** option on the **Main Menu**. This opens the **DishDVR Recorded Events** menu, which allows you to select and play back programs you recorded.



Tip: You can press the **CANCEL** button to back out of any menu. Unless you're in the Important System Information screen, if you want to immediately go back to watching a program no matter where you are in the menus, press the **VIEW** button.

Chapter 1

How to Get Started

Tip: You can pause a live program to answer the phone or get a snack!



17. Press the VIEW button to go back to watching a program.

Quick Tour of DishDVR Features

1. Watch a program for just a few minutes.
2. Press the PAUSE button to pause the program.



3. Press the PLAY button to watch the program from the point where you paused it.
4. Press the VIEW button to go back right away to the "live" program.
5. Press the SKIP BACK button to skip back about ten seconds in the program.





6. Press the **PAUSE** button and then press the **BACK** button to reverse the program in slow motion. Press the **BACK** button *once* to reverse the program 1/4 the speed as normal play. Press the **BACK** button *twice* to reverse at normal speed. If you press the **BACK** button again, the program reverses as described in step 7.



7. Press the **BACK** button *once* to reverse the program four times as fast as normal play. Press the **BACK** button *twice* to reverse at 15 times normal speed, *three times* to reverse at 60 times normal speed, and *four times* to reverse at 300 times normal speed.



8. Press the **PLAY** button.

Chapter 1

How to Get Started

9. Press the SKIP AHEAD button to skip ahead about 30 seconds in the play back.
Note: You cannot skip ahead if you are watching live TV.



10. Press the PAUSE button and then press the FWD button to forward the program in slow motion. When you press the FWD button *once* the program advances at 1/15 the speed of normal play. Press the FWD button *twice* to forward at 1/4 as fast as normal play. Press the FWD button *three times* to play the program at normal speed. If you press the FWD button again, the program advances as described in step 11.



11. Press the FWD ("FORWARD") button *once* to forward the program four times as fast as normal play. Press the FWD button *twice* to forward at 15 times normal speed, *three times* to forward at 60 times normal speed, and *four times* to forward at 300 times normal speed.



Tip: The DishDVR has features that let you decide how to watch TV!

12. Press the **VIEW** button to go back right away to the program in progress.
13. Press the **RECORD** button to start recording the program right now.
14. The **Start Recording Options** menu displays. Select **Manual user stop**. See page 48 for an explanation of the other recording options.



15. Select **Done** to start recording the program. Notice the receiver's front panel **RECORDING** light turns on.

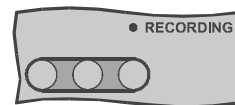

16. If you want, press the **STOP** button. This stops the receiver from recording the program.

Notice the receiver's front panel **RECORDING** light turns off.



17. Now, if you want to take the time, use the **Program Guide** to find another program set to start in the next few minutes.

Note: Start watching the program when it starts. Watch the program for a few minutes.

18. Press the **BACK** button to reverse the program.

Note: Let the program reverse all the way to its start.



19. Press the **RECORD** button. The receiver stores a recording of all of the program broadcast so far, and keeps on recording the program. You can record all of the program, even though you didn't start recording until after the program started.



20. Press the **DVR** button. This opens the **Recorded Events** menu on the TV screen.

Note: Even though the button on your remote control may be marked *DVR* or *PVR*, the remote control works the same way.



Tip: The DishDVR features let you record programs without using a VCR!

This is important: If you don't tune to a program until after it starts, you can record only the part of the program that comes after you tune to it.

Chapter 1

How to Get Started

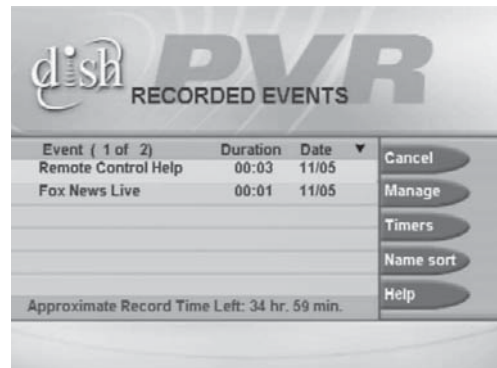

21. Use the remote control arrow buttons to highlight an event on the **Recorded Events** menu (it's OK to highlight an event you're recording).

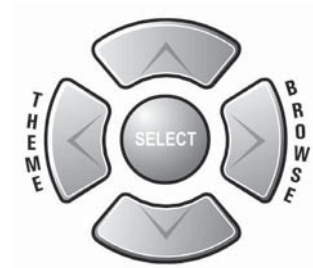

22. Press the remote control **SELECT** button to select the event you highlighted. This opens a menu of info about that event.
23. Press **VIEW** to return to your live programming.



Conclusion

This is the end of the quick tours. Continue on to the next chapter, *Parts of the System*, for a detailed description of your DishDVR receiver.

Chapter 2

Parts of the System

The Receiver

Receiver Front Panel

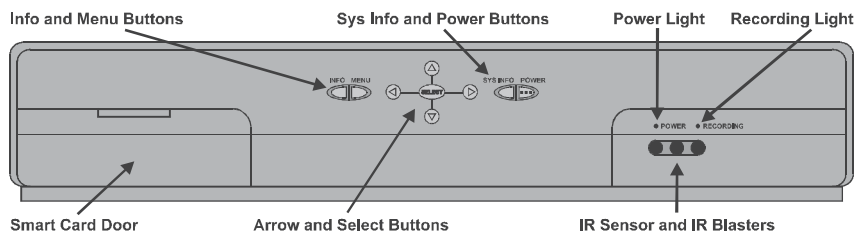

Smart Card Door

The Smart Card is behind the door on the front panel.

Note: Leave the Smart Card in, and keep the door closed.

Front Panel Buttons

The front panel buttons work the *same* way as the buttons on the remote, to control the receiver. For more information on the remote control buttons, see *Remote Control* on page 20 of this *User Guide*.

Info Button

Press the INFO button to see information about a program you watch or a program you highlight in a menu.



The information may include one or more of these signs:

- ⊗ for a program you can't buy
- ⊘ for a blacked-out program
- Ⓢ for a pay per view program
- ⌚ for a program with an event timer
- 🔒 for a locked program

Menu Button

Press the MENU button to open the **Main Menu**.



Tip: First, you move the highlight to an item with the Arrow buttons, and then you press the SELECT button to select that item.

Arrow Buttons

Use the ARROW buttons to move a menu highlight to an option or a program.

Use the UP and DOWN ARROW buttons to change channels while watching a program.

When watching a program, pressing the LEFT ARROW button opens the **Themes** menu and the RIGHT ARROW button opens the **Browse Banner**.

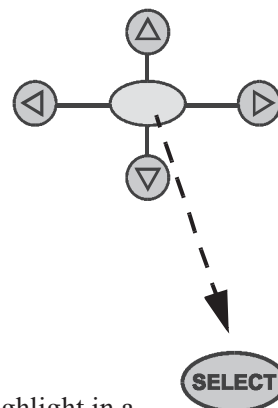

Select Button

Press the SELECT button to select an item you highlight in a menu.

Sys Info Button

Press the SYS INFO button to open the **Important System Information** menu.



Power Button

Press the POWER button to turn the receiver on or off.



Power Light

The POWER LED lights up when you turn the receiver on and turns off when you turn it off.

Note: Even when the POWER light is off, the receiver continues to work and requires power. Don't unplug the receiver unless you need to move it!

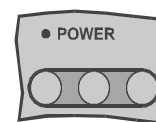

Recording Light

The RECORDING LED lights up whenever you are recording a program.

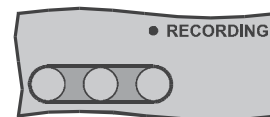

IR Sensor and IR Blasters

The IR SENSOR receives IR signals from the remote control. For information on the IR BLASTERS, please see *Control a VCR* on page 56.

Receiver Back Panel

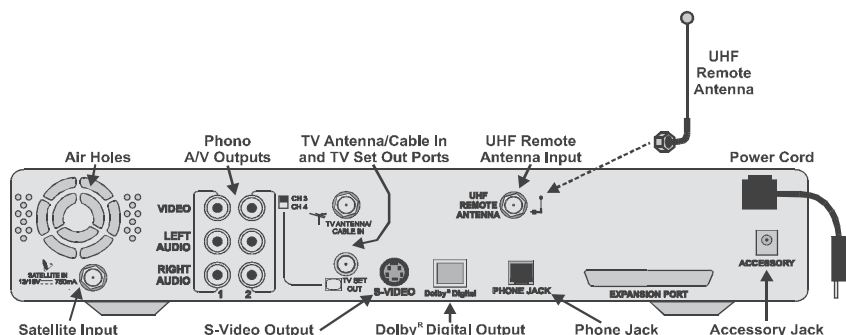

The receiver back panel has ports you can use to connect the receiver to other devices (you may not need to use some of these ports). The back panel also has the power cord and phone jack.



Tighten the connections *only* by hand. If you use a wrench you might over-tighten the connections and cause damage that *would not* be covered by the *Limited Warranty*.

Receiver Fan and Air Holes

The receiver has a fan behind the air holes. The fan turns on and off as needed to cool the receiver.

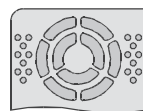

Don't block the air holes! If you do, the receiver could over-heat!

Satellite In

Connect the cable from the satellite dish to the **SATELLITE IN** port.



Channel 3/4 Switch

If you use **TV SET OUT** to connect the receiver to a TV, set this switch to the channel you want to tune to on your TV. Choose a channel that isn't used by a cable or local TV station. If you connect the receiver to a VCR that has a channel switch, set *both* switches to the same channel.

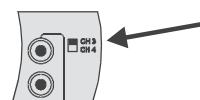

Note: If you are connecting multiple receivers to multiple TVs, these receivers and TVs can all be set to the same channel (3 or 4) to avoid interference with local broadcasts.

TV Set Out

This connection provides good picture quality and good mono sound quality (even if you have a TV or other devices that provide stereo sound).

If you use **TV SET OUT** to watch satellite channels, you must keep the TV(s) tuned to the same channel (either channel 3 or 4) as you selected on the Channel 3/4 Switch of the satellite receiver.

The **TV SET OUT** can be switched between satellite programming and the signal on the **TV ANTENNA/CABLE IN** connection using the **TV/VIDEO** button on the remote control.



TV Antenna/Cable In

Use the **TV ANTENNA/CABLE IN** to connect a broadcast TV antenna or cable TV box to the receiver. The **TV ANTENNA/CABLE IN** connection is only available through the **TV SET OUT** as described above.



Phono (RCA) Audio/Video Outputs

These outputs provide high-quality picture and stereo sound.

- If the TV has only one input for this type of audio, connect it to the receiver's **RIGHT AUDIO** output.
- If you use these outputs to connect the receiver to other devices, be sure to follow the instructions in the devices' user manuals.

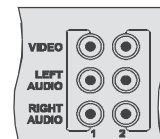

Super Video (S-Video) Output

The receiver provides S-Video, which is the highest quality video available. If you use this output for video, you *must* still connect the audio with the **PHONO (RCA) AUDIO OUTPUTS** or the **DOLBY® DIGITAL** output.



Dolby® Digital Output

The receiver provides Dolby® Digital encoded output and linear Pulse Code Modulation (PCM) for an audio amplifier/decoder that can process this kind of output.



Phone Jack

Connect a phone cable with a standard RJ-11 phone plug to the receiver here, and then connect the cable to an active phone jack.



Note: You *must* keep the receiver connected to a phone line at *all* times to buy Pay Per View programs or use exciting interactive features.

Expansion Port

This port is reserved for future use.



Accessory Jack

If you connect a multi-dish switch to the **ACCESSORY JACK**, or if you use an IR extender, you *must* set up the receiver properly. See *Set Up the Accessory Jack* on page 81.

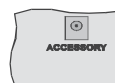

Power Cord

Even when the receiver front panel's green **POWER LED** is off, the receiver keeps working and it needs power. So, *don't* unplug the receiver's power cord unless you need to move the receiver or if it will not be used for an extended period of time.



Before moving the receiver, unplug the power cord and let the receiver sit for at least 30 seconds! Always handle the receiver *gently* to protect the *delicate* parts it has inside.

UHF Remote Antenna Input

The receiver uses the antenna to get UHF signals from the remote control. Connect the UHF antenna here, and set it so it doesn't touch anything. Set the antenna straight up so you can use the remote control as far away as possible.

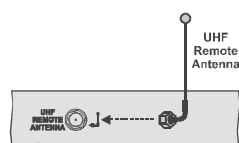

Attach an Attenuator

Stray UHF signals (from your neighbor's remote control, for example) can block signals from the remote control to the receiver. To help prevent blocks, you can install a 10 dB attenuator (you can buy one from a consumer electronics parts store).

Note: This will help keep out stray UHF signals, but also cut down how far away you can use the remote control.

1. Take the UHF antenna off of the receiver's back panel UHF REMOTE ANTENNA input.
2. Put a 10 dB attenuator onto the UHF REMOTE ANTENNA input.
3. Put the UHF antenna onto the attenuator.

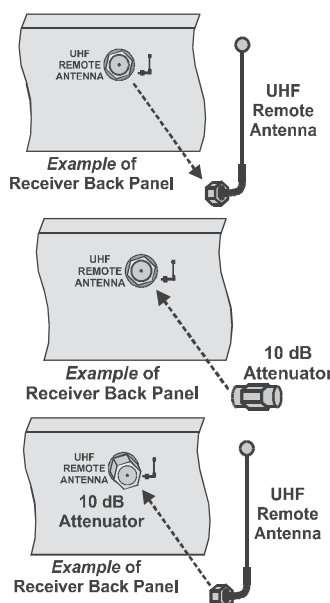

Tip: If the receiver does unexpected things (for example, changes channels, starts DVR features randomly), you may have to install a 10 dB attenuator to block stray UHF signals. You can buy one of these attenuators at almost any electronic parts store.

Remote Control

Tip: If the receiver does unexpected things (for example, changes channels, starts DVR features randomly), you may have to change the remote control address. See *Change the Address* on page 26.

This section describes the remote control and its buttons used to control the receiver. To find out how to use the remote to control *other* devices, see *Control Other Devices with the Remote*, beginning on page 68. The remote control we pack with the receiver may look a bit different than the one shown on page 22.



If you lose or damage the remote control, you can use the receiver's front panel buttons to operate many of the receiver's features. Call the Customer Service Center at 1-800-333-DISH (3474) to order a new remote.

The remote control uses *both* Ultra High Frequency (UHF) radio signals and infrared (IR) light signals to control the receiver but uses *only* IR signals to control other devices.

- IR signals travel only short distances (40 feet or less), and *can't* go through walls or other solid objects. You *must* point the remote control directly at the device you want to control, with *no* objects to block the signal path.
- UHF signals travel long distances (100 feet or more) and *can* go through walls and other solid objects. Because UHF signals travel so far, the receiver may respond to signals from other nearby remote controls (for example, your neighbor's remote control). To handle this problem, please see *Change the Address* on page 26. If this doesn't work, please see *Attach an Attenuator* on page 19.

Note: To use UHF capabilities, you need to connect your UHF antenna as described on page 19.

Remote Control Batteries

The remote control comes with AAA batteries. When you replace old batteries, you should replace *all* of the batteries. Use batteries of the same kind, *for example* alkaline or carbon zinc, and *don't* mix batteries of different kinds. Alkaline batteries last longer.

Changing the Batteries

1. Press down on the battery cover's top latch and lift the cover off.
2. Take out all of the old batteries.
3. Put the new batteries in. Make sure you match the plus (“+”) ends with the plus markings on the battery case.
4. Fit the battery cover's bottom tab back into the slot at the bottom of the battery case, and snap the cover back into place.



Low Battery Warning

When you see a low battery warning message on the bottom line of the **Program Banner**, the batteries in your remote control are weak and need to be replaced.

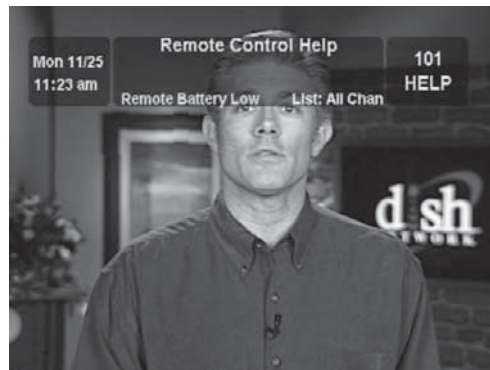

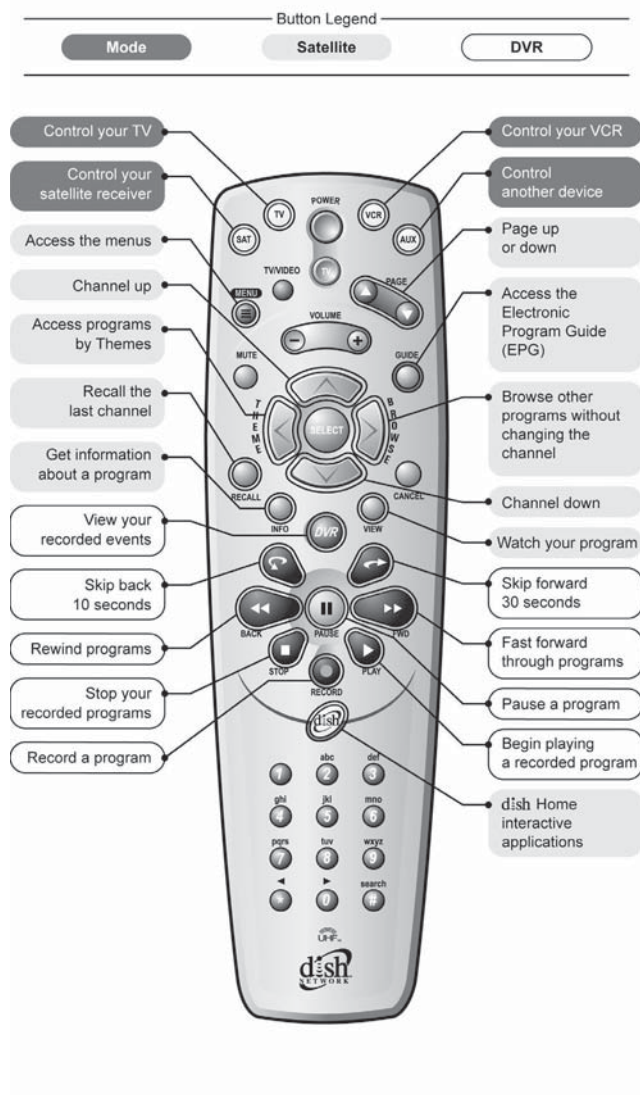

Remote Control Buttons

SAT Mode Button

Press this button to set the remote to SAT (“satellite”) mode. The SAT mode button’s back light lights up for two seconds to show you’ve set the remote to SAT mode. While the remote control is in SAT mode, the remote control buttons operate as described below to control satellite receiver functions.



Power Buttons

Press the blank **POWER** button to turn the receiver on or off.

Use the **TV POWER** button to turn the TV on or off. See *Set Up the Remote to Control Other Devices* for instructions on programming the remote to control your TV.

Menu Button

Press this button to open the **Main Menu**.

TV/Video Button

If you connect a second video source, such as cable or a broadcast antenna, to the receiver's back panel **TV ANTENNA/CABLE IN** port, you can use this button to switch the receiver between the satellite signal and the another video signal.

Note: The signal from the second video source will only be available on the **TV SET OUT** port, not on the **S-VIDEO** or **RCA** output connectors.

Page Up and Page Down Buttons

Press the **PAGE UP** button or the **PAGE DOWN** button to scan, page by page, through the **Program Guide**, a **Themes** list, a **Favorite List**, an **Event Timers** list, or a list of channels.

Mute Button

Press this button to turn the TV sound off or on. To use this button, you *must* set up the remote to control your TV. See *Set Up the Remote to Control Other Devices* for instructions.

Volume Button

Press this button to change the TV volume. To use this button, you *must* set up the remote to control your TV. See *Set Up the Remote to Control Other Devices* for instructions.

Guide Button

Press this button to open the **Program Guide**. When you have the **Program Guide** open, press this button again to change the **Favorites Lists**.

Arrow Buttons

- Press these buttons to highlight an option in the menus, the **Program Guide**, and the **Browse Banner**.
- While watching a program, press the **UP** or **DOWN ARROW** button to change channels.
- While watching a program, press the **BROWSE** button (the **RIGHT ARROW** button) to open the **Browse Banner**.

POWER



MENU



TV/VIDEO



PAGE



MUTE



VOLUME



GUIDE

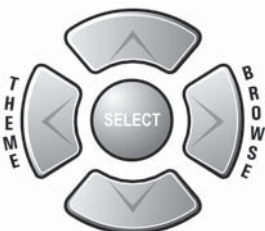

Tip: The **Guide** button opens the **Program Guide**. Use it to get information on programs that are on now and that will be on in the future.

- While watching a program, press the **THEME** button (the **LEFT ARROW** button) to open the **Themes** menu.
- To enter a number in a menu, highlight the place where you need to enter the number. Then, press the **UP** or **DOWN ARROW** button to increase or decrease the number in the highlighted place. Or, you can use the number buttons.

Select Button

Press this button to select the option you highlight in a menu, **Program Guide**, or **Browse Banner**.



Recall Button

Press this button to go back to the last receiver channel you watched. Press it *again* to switch between the last two receiver channels you watched.



Info Button

- Press the **INFO** button for more information about the show you are watching.
- Press the **INFO** button for more information about a program you have highlighted in the **Program Guide**, **Browse Banner**, **Themes**, or **Recorded Events** list.
- If a menu has a **Help** option, press this button to see help information for that menu.



View Button

- While watching a program, press this button to briefly display the **Program Banner**.
- When you use a menu, press this button to cancel out of the menu and go back to watching a program.



Cancel Button

Press this button to cancel and return to the previous menu or to watch a program if there are no previous menus.



CANCEL

Number Buttons

- While watching a program, using the **Program Guide**, or using the **Browse Banner**, use these buttons to enter a channel number.
- When you have the **Program Guide** open, enter a number of hours you want to skip forward with these buttons, and then press the **RIGHT ARROW** button. This is how you can quickly move the **Program Guide** forward. To move back, enter the number of hours you want to move back and then press the **LEFT ARROW** button.
- If a menu option has a number, press the button with the same number to select that option.
- Use these buttons to enter numbers in a blank field.



Tip: When you're in the **Program Guide**, you can skip ahead 24 hours just by pressing the **SKIP AHEAD** button on the remote.

If you skip ahead, you can skip back 24 hours by pressing the **SKIP BACK** button.

Star (*) Button

Press this button to back space while using the **Search** function of your receiver.



Zero Button

Press this button to move one character forward while using the **Search** function of your receiver.



Pound (#) Button

Press this button to display the **Search** screen. Also, you use this button in several procedures described in this *User's Guide*.



search

Dish Button

Press this button to use the **Dish Home Interactive TV** applications. See page 81 for information on using this exciting new feature.



DVR Buttons

Use these buttons to record or play back a DVR program. See *Use the DVR Features* for details.

Note: Even if the top button says "PVR" instead of "DVR," it works the same.



Tip: DVR buttons let you take control of television. You can use them to pause live TV, go back in time, skip ahead, and more!

Change the Address

Because UHF signals travel long distances and go through walls, a neighbor's remote could control your receiver by mistake. To handle this problem, you can change the address on the remote and receiver as follows:

1. Make sure you turn on the TV and receiver.
2. Open the **Important System Information** menu by pressing the receiver's front panel SYS INFO button.
3. The **Important System Information** menu shows a **Remote Address**.

SYS INFO

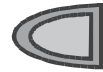

Write down this number: _____

4. Press and hold the SAT mode button about three seconds, until all the mode buttons light up, and then let go of the SAT button.
5. Use the number buttons to enter any number from 1 to 16, but *not* the one you wrote in step 3.



Write down the number you enter: _____

6. Press the POUND (#) button. If you entered the address correctly, the SAT mode button flashes three times.
7. Press the RECORD button.
8. Make sure the **Remote Address** you see on the **Important System Information** menu now is the same as the one you entered in step 5. If the addresses are not the same, repeat step 7.
9. To check the address in the remote control, *press and hold* the SAT mode button for three seconds. Then, let go of the SAT button, and press the POUND (#) button *twice*. The SAT mode button flashes the same number of times as the address you entered in step 5.

Press the SELECT button to close the **Important System Information** menu.

Receiver Menus

This section shows examples of the key menus the receiver displays on the TV screen and how to use them.

Open or Close a Menu

- Press the MENU button to open the **Main Menu**. You can open *any* other menu starting from the **Main Menu**.
- Press the CANCEL button to close a menu.

Make a Choice in a Menu

1. Use the remote control ARROW buttons to highlight a menu option. An option you highlight looks like the English option shown below.
2. Press the remote control SELECT button to select the option you highlight.



Note: If a menu option has a number, you can press the remote control's number to select that option. If you do this, you don't have to highlight the option first. For example, to select the **Program Guide** option on the **Main Menu**, just press the remote control 1 button.



Make a Choice in a List

The menus have two types of lists, like these *examples*:

- A **single choice** list lets you make *only one* choice at a time. If you make another choice, you *don't* keep your earlier choice.
- A **multiple choice** list lets you make *more than one* choice at a time. If you make another choice, you *keep* your earlier choice(s).



Tip: Whenever a menu option has a number next to it, you can just press that number on the remote to instantly access it.

Chapter 2

Parts of the System

Tip: Any time you're in a menu and want to immediately go back to watching your program, just press the View button.

Here's what to do:

1. Use the ARROW buttons to highlight an option.
2. Press SELECT to choose the option(s).
3. Select **Save**.

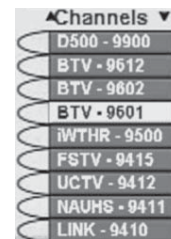

SAVE

Cancel a Procedure

To cancel a procedure, press the remote control CANCEL or VIEW button *before* you do the last step of the procedure.

- To go back to watch a program, press the VIEW button.
- To go back to the previous menu, press the CANCEL button.



Note: If you don't do anything in a menu for several minutes, the menu times out. This throws away any change you made, and displays the last channel you watched.

TV and VCR Connections

Use the following diagram and instructions to connect the satellite receiver to a TV and VCR (optional).

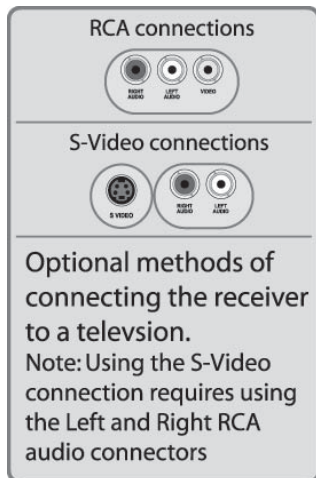
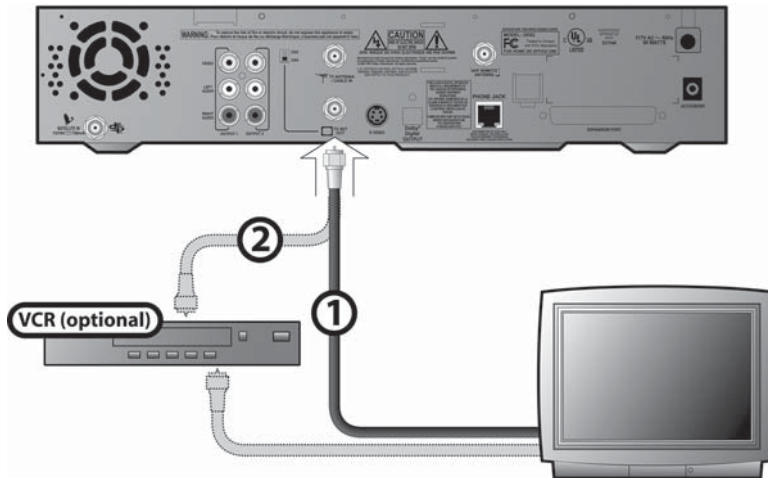

- 1** **TV Set Out to a TV** - Connect a coaxial cable between the **TV SET OUT** on the receiver and the TV's input. Be sure to set the **CHANNEL 3/4** switch on the receiver to the channel you use to watch satellite TV.
- 2** **TV Set Out to a VCR (Optional)** - Connect a coaxial cable between the **TV SET OUT** on the receiver and the VCR's input. Connect another cable between the VCR's output and the TV's input. Be sure to set the **CHANNEL 3/4** switches on the receiver and VCR to the channel you use to watch satellite TV.

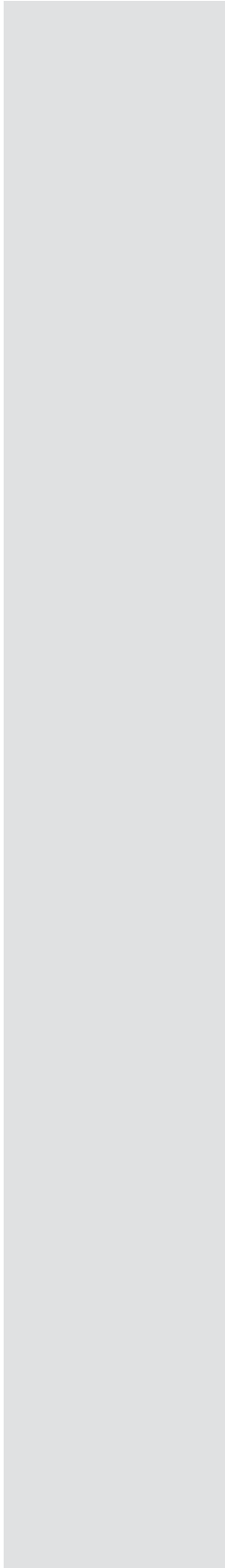

Chapter 3

Using the System

Change Channels

You can change channel on your satellite receiver while watching a program by doing one of the following:

- Press the remote control **UP** or **DOWN ARROW** button to change the channel.



- Use the **NUMBER PAD** buttons to enter the channel number you want.

Note: If you apply a **Favorites List**, you can use the **UP** or **DOWN ARROW** buttons to change channels on the list you apply, or use the number buttons to change to any channel, even if it is not on your applied list. The receiver skips over blocked channels if you hide them and lock the receiver. See page 38 for information on **Favorites Lists**.



Use the Program Guide

You can use the **Program Guide** to see what programs are on and to change channels.







- The first time you use the receiver, it will take a little while to display the **Program Guide**. A message may be displayed indicating that the **Program Guide** needs to be updated. This is normal.
- A *red* background behind a channel usually means you haven't subscribed to the channel. Once you buy a channel, you can tune to it. To order a channel, please call 1-800-333-DISH (3474) or use the **Dish** button to order through the Customer Support application.

Tip: The Program Guide is your key to satellite TV programs. The receiver displays the Program Guide on the TV screen.

Tip: Be sure to turn off the receiver (so the green power light is off) when you're not using it. This way, the Program Guide will be automatically updated, and you won't have to wait for it to be updated when you're watching a program.

- The **Program Guide** shows which **Favorites List** you apply. Pressing **GUIDE** scrolls through the available **Favorites Lists**:
 - **All Chan** - Displays all of the channels available on DISH Network.
 - **All Sub** - Displays all of the channels in your subscription.
 - **Other Favorites Lists** - Displays *only* the channels on a particular list. See *Use Favorites Lists* for more information.
- The **Program Guide** shows programs that are on now and those that will be on during the next seven to nine days. The guide *doesn't* show programs that have ended.

Note: You can only get the seven to nine-day **Program Guide** from the 110 West satellite. If your system does not receive 110 West, the **Program Guide** will display information on programs for only two days.
- You can hide adult channels so the **Program Guide** doesn't show them. Please see *Hide or Show All Adult Channels* on page 47.
- You will find any of the following symbols in the Program Guide:
 - **(DD)** in the programming titles means a program has Dolby® Digital sound.
 -  for a program you can't buy
 -  for a blacked-out program
 -  for a pay per view program
 -  for a program with an event timer
 -  for a locked program

Display the Last Channel You Watched in the Program Guide

You can set up the **Program Guide** to either show or not show the channel you are watching in its upper right-hand corner.

1. Press the **MENU** button.
2. Select the **System Setup** option.
3. Select the **Guide Displays** option.
4. Select the **Partial guide with video** option or the **Full guide without video** option.
5. Select the **Save** option.

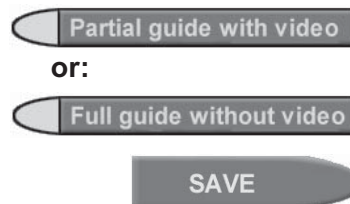

Set the Channel Order in the Program Guide

You can set up the **Program Guide** to list channels in *ascending* order (with the highest channel number at the top), or in *descending* order (with the highest channel number at the bottom).

Note: If you don't set a channel order, the **Program Guide** lists the channels in *descending* order.

1. Press the MENU button.
2. Select the **System Setup** option.
3. Select the **Channel Order** option.
4. Select the **Ascending** or **Descending** option.
5. Select the **Save** option.

MENU



mno



mno



Select a Program in the Program Guide

1. Press GUIDE to open the **Program Guide**.
2. Move around the **Program Guide** to highlight a program using the following ways:

GUIDE



- Use the NUMBER PAD buttons to enter the channel number you want. This will move the **Program Guide** to show the channel you enter and some others.
- Use the ARROW buttons to move the highlight around the **Program Guide**.
- Jump through the **Program Guide** in large steps forward or backward in time:



- a. Use the NUMBER PAD to enter the number of hours you want to skip. Press the RIGHT ARROW button to skip forward, and then the LEFT ARROW button to skip backward.
- b. Use the SKIP AHEAD or SKIP BACK feature to move the **Program Guide** ahead or back a full 24 hours.



Note: When you use the **Program Guide**, if the receiver needs to get the latest information (which might take a few minutes), it'll display a message that asks you to let it download new program information. As it downloads, the receiver displays a status bar. To avoid getting this message, turn the receiver off when you're not using it. It'll get the latest information by itself and maintain an updated **Program Guide**.

3. After you have highlighted the program you want, you can press the INFO button for more information about the program. If you do, press the CANCEL button to go back to the **Program Guide**.
4. Press the SELECT button to change to the highlighted program. If you select a program that is on in the future, the receiver will display a message to create a timer. See *User Event Timers* on page 48.
5. Press the CANCEL or VIEW button to close the **Program Guide**.



Use the Program Banner

You can use the **Program Banner** to find out more about a program you watch, *while you watch it*. The receiver displays the **Program Banner** for a few seconds at the top of the TV screen every time you change the channel or press the VIEW button.



Tip: Whenever you change channels, the Program Banner appears for a few seconds with information on the program that's playing on that channel.



Note: When you see a low battery warning message on the bottom line of the **Program Banner**, the batteries in your remote control are weak and need to be replaced.

Use the Browse Banner

You can use the **Browse Banner** to see what other programs are on and *not* miss any of a program you are watching. The **Browse Banner** shows information on the program you are watching at the *top* of the TV screen, and information on other programs at the *bottom* of the TV screen. The **Browse Banner** stays on the TV screen until you close it.

In this example, the **Browse Banner** shows information on a program we're watching at the top, and information on *another* program at the bottom.



The bottom **Browse Banner** displays the **Favorites List** that is currently applied. If the **All Chan** list is applied, the **Browse Banner** shows *all* channels. If another **Favorites List** is applied, the banner shows *only* the channels on that list. If you hide adult channels and lock the receiver, the banner *doesn't* show adult channels.

Select a Program with the Browse Banner

While you watch a program, press the **BROWSE** (right arrow) button to get information on other programs.

With the Browse Banner open:

1. Move through the programs and highlight a desired program by doing the following:
 - Press the **UP** or **DOWN ARROW** button to change the channel information you see at the *bottom* of the TV screen, or use the number buttons to enter a channel number. The **Browse Banner** shows information about the program on now on that channel, at the *bottom* of the TV screen.
 - Press the **RIGHT ARROW** button to see information about the next program on the channel you chose. If you do this, press the **LEFT ARROW** button to go back to the current program on now on that channel.
2. Press the **INFO** button for more information about the highlighted program at the *bottom* of the TV screen. If you do this, press the **CANCEL** button to go back to the **Browse Banner**.
3. Select a highlighted program with the **Browse Banner**:

If the program is on now, the channel will change to the selected program.

If the program occurs in the future, this opens a menu where you can set an *Event Timer* for the program, as described on page 48.
4. To exit the **Browse Banner**, press the **CANCEL** button.

Tip: If you have a DSL line, the receiver's modem may not be able to dial out. If so, you will need to get a DSL filter and install it between the receiver and the phone wall jack. You should be able to obtain one of these filters from your DSL provider.

Remember: Enjoy your Pay Per View events but be careful. You cannot cancel the purchase of any Pay Per View events once you confirm.

Buy a Pay Per View Program



Once you confirm an order for a pay per view program, you *can't* cancel thereafter and we'll bill you for it.

You *must* pay for all programs you or anyone else buys with the receiver. To lock pay per view, see *Lock or Unlock All Pay Per View Programs* on page 46.

To buy pay per view programs, you *must* connect the receiver to an active phone line.

You can watch a pay per view program on TVs connected to as many as six different receivers. You will pay for the program only once, but you *must* order the program for *all* the receivers you will watch it on.

How to Buy a Pay Per View Program

1. Select a pay per view program in the **Program Guide**. Pay per view programs are marked "PPV" in the **Program Guide**.
2. To buy the pay per view program, select the **Yes** option. If you don't want to buy the pay per view program, select the **No** or **Cancel** option.

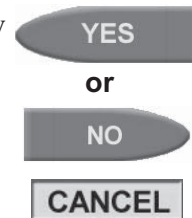

3. A menu displays asking you to confirm your order. Select the **Yes** option to confirm the order and we will bill you for it. Select the **No** or **Cancel** option to cancel the order.

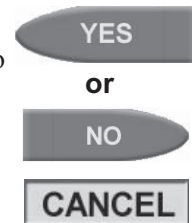

Review Pay Per View Programming You Have Purchased

1. Press the MENU button.
2. Select the **System Setup** option.



3. Select the **Purchase Info** option. This opens a list of shows you've bought, both the ones you've watched and the ones you haven't watched yet.
4. Select the **Cancel** option to close the list.



Use Themes

1. While you watch a program, press the **THEME (LEFT ARROW)** button to open the **Themes (Theme Categories)** menu.

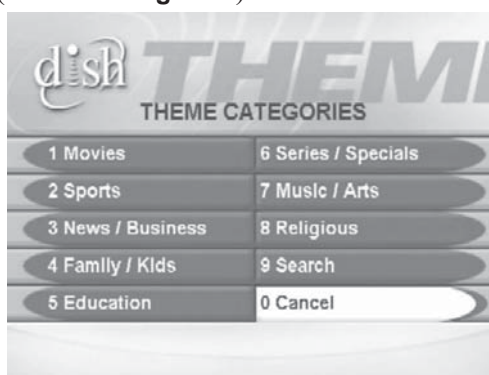

2. Select a **Theme** category. This opens a list of programs that match the **Theme** you selected like this example.



Note: If you hide adult channels and lock the receiver, **Themes** lists will not show programs on adult channels.

Note: Programs colored in red are those that are not in your subscription.

3. Move through the list of programs using the **UP** and **DOWN ARROW** buttons or a page at a time using the **PAGE UP** and **PAGE DOWN** buttons on the remote control.



Tip: Favorites Lists let you set up lists of your favorite channels. When you apply one of these lists in your Program Guide, you see only your favorite channels — making it much easier to find programs to watch.

4. Highlight the program you want. You can press the **INFO** button for more information about the program you highlight. If you do, press the **CANCEL** button to go back to the list of programs.
5. Press the **SELECT** button to watch the program or set a timer.

Use Favorites Lists

You can set up lists of your favorite channels to appear in the **Program Guide**. These lists can include any channels you want.

Note: If you hide adult channels and lock the receiver, *no Favorites List* will show adult channels.

You must do two things to use Favorites Lists:

1. Set up the list(s) you want. Please see *Set Up or Change a Favorites List* on page 39.
2. Apply a list. See *Apply a Favorites List* on page 40.

About Favorites Lists

- When you apply a Favorites List, the **Program Guide** shows *only* the channels in that list. To choose channels in the list, press the remote control **UP** or **DOWN ARROW** button.
- To choose a channel whether or not it is on the **Favorites List** you apply, use the number buttons to enter the channel number.
- The **All Chan** list includes *all* the channels. You *can't* make any changes to the **All Chan** list.
- The **All Sub** list includes all the channels you buy. You *can't* make any changes to the **All Sub** list unless you change what you buy. To do so, please call 1-800-333-DISH (3474) or press the **DISH** button to go to **Dish Home Interactive TV Applications**.
- You can use up to four custom Favorites Lists. You can give each list a name. When you first get the receiver, the four lists have the names **List 1**, **List 2**, **List 3**, and **List 4**. The lists are empty until you add channels to them.
- You can add *as many channels as you want* to *each* list.

Set Up or Change a Favorites List

1. Press the **MENU** button.
2. Open the **Favorites Lists** menu.
3. Select the list you want to change. A check mark shows up next to the list. *For example*, here we selected **List 1**.

MENU



ghi



4. Select the **Modify List** option.
Note: You cannot modify the **All Chan** and **All Sub** lists.

MODIFY LIST

5. In the **Channels** list, select a channel or channels you want to add to the list. A check mark shows up next to each channel. *For example*, here we selected **USA - 102**, **LIFE - 108**, and **HGTV - 112**.

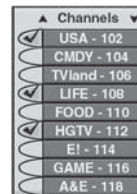

You can select the **Clear** option to remove all the channels from the channels list.

CLEAR

6. To delete a channel, select the channel again. The check mark next to the channel goes away.
7. Select the **Save** option to save your changes.

SAVE

Change a Favorites List's Name

1. Open the **Favorites Lists** menu.
2. Select the list whose name you want to change. A check mark shows up next to the list. *For example*, here we selected **List 1**.
3. Select the **Edit List Name** option.
4. Select the **Clear** option if you want to clear the list's name.

MENU



ghi



EDIT LIST NAME

CLEAR

Tip: Be sure to set up a list of your favorite channels because it makes finding programs to watch much easier!

Chapter 3

Using the System

Tip: It's easy to apply a Favorites List. Just press GUIDE on the remote repeatedly, and watch for the name of your list to appear in the upper left most area of the Program Guide

5. Select a letter on the on-screen keypad (it's just like selecting a menu option). *For example*, here we selected **B**. Do this *again* to spell out the name. You can enter up to eight letters, numbers, or spaces. If you need to, select the **space** option to insert a space in the name or the **back** option to correct a letter.

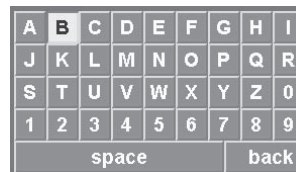

6. Select the **Save** option to save your changes.



Apply a Favorites List

To apply a Favorites List, do the following:

- If the **Program Guide** is open, press the **GUIDE** button repeatedly until the list you want appears. The **Program Guide** shows which list you apply.

Note: Unless you add channels to at least one custom list, you can apply *only* the **All Chan** list or the **All Sub** list.

Use the Search Feature

The **Search** feature allows you to search the **Program Guide** for programs or program information.

1. Press the **SEARCH** button.



2. The **Search** menu will open.



3. Move the highlight to the **Name** box.

4. There are two ways to enter the name of the program you want to find:

- Use the UP, DOWN, LEFT, and RIGHT ARROWS to scroll around on the virtual keyboard and then select the letters you want.
- Use the remote control number pad to enter the letters in the **Name** box. Numbers 2 through 9 have telephone-style numbers written above them. To enter an H, for example, press 4 twice because H is the second letter listed above the 4 on the number pad. For example, if you are searching for *Rudy*:

Press  three times for an R.

Press  twice for a U.

Press  once for a D.

Press  three times for a Y.

Note: Enter up to 14 characters (letters and spaces) for your search.

5. When you have entered the name, scroll down to choose between two options:

- **Search Event Titles Only** - Select this option when you are sure the word(s) you entered are part of the event title.
- **Search All Event Info** - Select this option if you want to search event titles and information for the word(s) you entered.

6. Select the **Search** option. When the search completes, you will see a screen listing the name of the program(s) and the start and stop times.

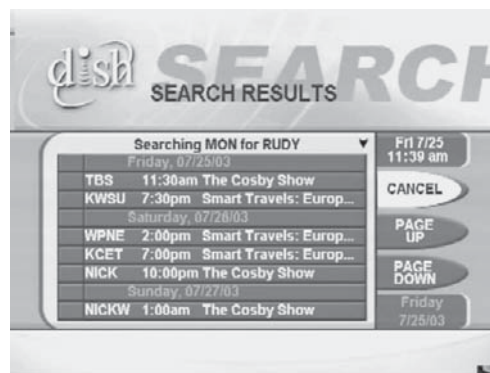

7. Highlight the program you want to watch or record and press **SELECT**.

Tip: You can lock out programs by a rating such as PG-13, or you can lock out entire channels.

8. If the **Create An Event Timer** menu opens, select **Create** to record the program. See *Use Event Timers* for more options on setting up timers.
9. After setting up the timer, select **Cancel** to exit the menu or press **View** to go back to watching a program.

Use Locks

The Locks feature allows you to lock out certain programming, channels, or receiver functions. The locks can be unlocked using a special password.

Note: You can set up a Personal Identification Number (PIN) with the Customer Service Center so *only* you can order services by phone. See *Personal Identification Number* on page 48 for more information.

- You can set locks *and* lock the receiver so *only* someone who knows the password can get to locked channels or programs.

You must do two things to use locks:



1. **Set up the locks** you want (see the next few pages).
2. **Lock the receiver.** This is how you apply the locks you set up (that is, how you make them work). See *Lock or Unlock the Receiver* on page 47.

Open the Locks Menu

1. Press the MENU button.



2. Select the **Locks** option.

This opens the **Locks (Parental and System Locks)** menu.

Note: If you've locked the receiver previously, you *must* enter the password to open the **Locks** menu.



3. On the **Locks** menu, select the option for the lock you want to set.

Set or Change the Password

1. Press MENU and then select the **Locks** menu.

Note: If you've locked the receiver previously, you *must* enter the existing password to open the **Locks** menu. So, unless you *know* the password you *can't* change it.

2. Select the **Change Password** option.

3. Use the number buttons to enter the password you have now. The receiver displays stars (*) as you enter the digits of the password. When you enter the last digit of the password, the receiver highlights the **OK** option. Press the **SELECT** button.

4. Enter the new password.

5. Enter the new password again to confirm your choice.

6. Select the **OK** option again.

7. Memorize your new password.

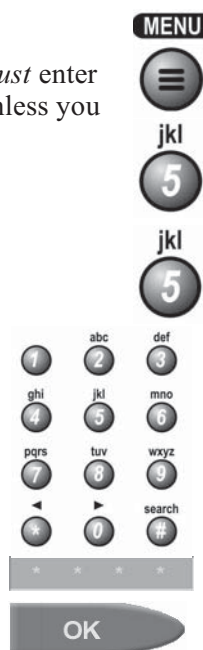

Important: If you create a password, be sure to write it down and put it away some where safe, as you will not be able to change any locks or unlock the receiver without it.

If You Forget the Password

If you forget the password, call the Customer Service Center at 1-800-333-DISH (3474). You may need to give us information such as your name, your address, your telephone number, the receiver serial number (see *Order Your Program Packages* on page 3), and your Personal Identification Number (PIN), if you use one (see page 48).

Tip: If you forget your password, call Customer Service at 1-800-333-DISH (3474)

Rating Code Locks

- Rating code locks use the codes the *original program providers* assign to the programs. The actual content of the programs *may be different* from the assigned ratings.

Note: No rating system can guarantee that *all* unwanted material is screened out.

- Like all other locks, these locks work *only* when you lock the receiver.
- You can lock *any* satellite program, *even* a pay per view program.
- The locks built into some TVs (“V chip” locks) *don't* work for satellite programs.
- TV program ratings are *different* from movie ratings.
- Receiver locks *don't* work for TV programs.

Tip: If you have the password, you can lock and unlock any channel, including pay per view channels.

- **Rating Codes:**

G: General Audience. Suitable for young children.

PG: Parental Guidance suggested.

PG-13: Parental Guidance suggested. Not recommended for children under 13.

R: Restricted. Not recommended for children under 17 unless accompanied by an adult.

NC-17: Not recommended for Children under the age of 17.

NR/AO: Not Rated/Adult Oriented

- **Expanded Ratings:**

L: Language. Adult language.

V: Violence. Graphic Violence.

SC: Sexual Content. Sexual scenes.

N: Nudity. Nude scenes.

Set or Change Rating Code Locks

1. Press MENU and then select the **Locks** menu.

MENU



jkl



2. Select the **Ratings Locks** option.

3. Select the rating for the *youngest* viewers you want to protect. This *also* selects ratings for programs for more *mature* viewers. *In the example here*, if you lock PG-13 rated programs, you also lock all programs with the R, NC-17, and NR/AO ratings.

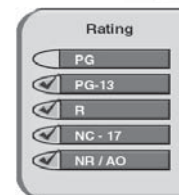

4. Select the expanded rating code(s), if you want to lock these ratings too. *For example*, here we selected **Language**.



Note: You can select any, all, or none of these rating codes.

5. To *unlock* a rating code, select the code.
6. Select the **Save** option to save your changes.
7. You *must* lock the receiver to apply the lock you just set. See *Lock or Unlock the Receiver* on page 47.

SAVE

Set or Change Channel Locks

Note: You can lock *any* channel, even a pay per view channel.

1. Press **MENU** and then select the **Locks** menu.
2. Select the **Channel Locks** option. Select the channel(s) you want to lock. A checkmark shows up next to the channel(s), as you can see in this *example*.
3. To *unlock* a channel, select that channel. The checkmark next to the channel goes away.

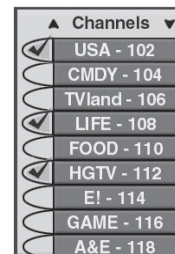

4. Select the **Save** option to save your changes.



5. You *must* lock the receiver to apply the lock you just set. See *Lock or Unlock the Receiver* on page 47.

Lock or Unlock the Receiver Front Panel Buttons

Note: You can lock the receiver buttons and hide the remote to limit how people use the receiver.

Note: Even if you lock the receiver front panel buttons, the **POWER** button will continue to work.

1. Press **MENU** and then select the **Locks** menu.
2. Select the **Front Panel Lock** option. The **Lock Front Panel Buttons** pop-up displays.

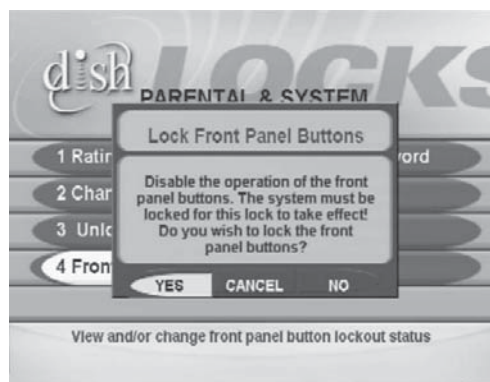

3. Select the **Yes** option.



4. You *must* lock the receiver to apply the lock you just set. See *Lock or Unlock the Receiver* on page 47.

To unlock the receiver front panel buttons:

1. Press MENU and then select the **Locks** menu.
2. Select the **Front Panel Lock** options **Unlock Front Panel** Buttons pop-up displays.

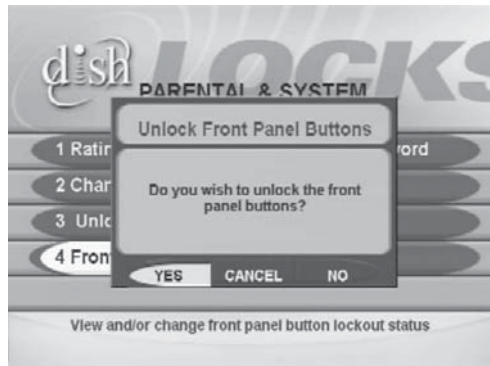

3. Select the **Yes** option.

YES

Lock or Unlock All Pay Per View Programs

Note: This locks *all* pay per view channels. You can lock one or more channel(s) with channel locks or rating code locks.

To lock all pay per view programs:

1. Press MENU and then select the **Locks** menu.
2. Select the **Lock PPV** option.
3. You *must* lock the receiver to apply the lock you just set. Please see *Lock or Unlock the Receiver* on page 47.

To unlock all pay per view programs:

1. Press MENU and then select the **Locks** menu.



2. Select the **Unlock PPV** option.

Hide or Show All Adult Channels

You can keep the **Program Guide**, **Themes** lists, **Favorites Lists**, and the **Browse Banner** from showing *any* adult channels. This means no one can tune to adult channels with the remote control **UP** or **DOWN ARROW** button or number buttons.

Note: This locks *all* adult channels. You can lock one or more adult channel(s) with channel locks or rating code locks.

To hide all adult channels:

1. Open the **Locks** menu.
2. Select the **Hide Adult** option.
3. You *must* lock the receiver to apply the lock you just set. Please see *Lock or Unlock the Receiver*, below.

To show all adult channels:

1. Open the **Locks** menu.
2. Select the **Unhide Adult** option.

Lock or Unlock the Receiver

To lock the receiver:

1. Press **MENU** and then select the **Locks** menu.
2. Select the **Lock System** option. The receiver displays a message that tells you to enter the password.
3. Use the number buttons to enter the password. The receiver displays stars (*) as you enter the digits of the password. When you enter the last digit of the password, the receiver highlights the **OK** option. Press the **SELECT** button.
4. The receiver displays a message that tells you to enter the password again. Do so, and then select the **OK** option again. *This applies all the locks you set.*

To unlock the receiver:

1. Press **MENU** and then select the **Locks** menu.
2. Because the receiver is locked, it displays a message that tells you to enter a password. The receiver displays stars (*) as you enter the digits of the password. When you enter the last digit of the password, the receiver highlights the **OK** option. Press the **SELECT** button.
3. Select the **Unlock System** option.



jkl



def



Tip: You can lock single adult channels or all adult channels. Just remember that you will need the password to unlock them.

Tip: To use Locks, you must set the locks you want, and then lock the receiver.

When You've Locked the Receiver

- If you try to watch a locked channel or program, erase a protected DishDVR recording, or open the **Locks** menu, the receiver displays a message that tells you to enter the password.
- The receiver gives you three tries to enter the right password. If you can't do this, the receiver doesn't let you try again for several minutes. If you enter the right password, you can watch a locked channel or program or open the **Locks** menu.
- If you leave a locked channel or program or the **Locks** menu, you *must* enter the password *again* to see the channel, program, or **Locks** menu again.
- If you unlock the receiver, leave the locks unchanged, and then lock the receiver *again*, you apply the *same* locks as before.

Personal Identification Number

You can set up a Personal Identification Number (PIN) for call-in requests *only*. Anyone who calls the Customer Service Center *must* provide this PIN to make any changes to your account, to buy services, or to get information. You can call the Customer Service Center at 1-800-333-DISH (3474) at any time to set up a PIN.

If you forget your PIN, you *must* call the Customer Service Center. We may ask for more information to make sure it's okay for you to make changes to your account.

Use Event Timers



Many satellite TV programs and films are copyrighted. In some cases, copyright law may apply to private, in-home recording.

Event timers let you set up the receiver to tune in future programs and/or record them, with the DishDVR features or a VCR.

- An “event” is a program, sports event, pay per view movie, or anything else on satellite TV.
- You can quickly set a one-time event timer with *Quick Record*. See page 50.
- You can set an *automatic* event timer for a program listed with start and stop times in the **Program Guide**. This can be a program that comes on each day or each week. See page 51.
- A *manual* event timer lets you set custom start and stop times for a timer. You can use a manual timer to record *part of a program*, *several programs together*, or *parts* of several programs. See page 52.

- If you use an event timer, you can record *only* the channel you've got tuned. This means you *can't* record one program and watch or record another "live" program at the *same* time.
- If you open a menu while you record to a VCR, the tape *may* record the menu. If you change the volume or press the MUTE button, the tape *may* record the change depending on how your VCR is connected in your system.

Note: If you want to have Event Timer record to a VCR, you must set up the receiver to control the VCR. See *Control a VCR* on page 56.

Note: Even if the systems shows "PVR" instead of "DVR," it works the same way.

Event Timer Types

DVR	Reminds you a program is about to start; tunes the receiver to the program when it begins; records the program with the DishDVR features.
Auto-Tune	Reminds you a program is about to start; tunes the receiver to the program when it begins.
Reminder	Reminds you a program is about to start.
VCR	Reminds you a program is about to start; tunes the receiver to the program when it begins; starts a VCR to record the program.

Event Timer Frequencies

Once	Works for a one-time <i>program</i> . If the program time changes, this timer works at the <i>new</i> time. The receiver <i>deletes</i> this timer right after the timer works. Note: A Once timer keys on a program, <i>not</i> a time. So even if the program comes on late, the timer works for it.
Weekly	Works once a week on the same <i>channel</i> at the same <i>time</i> on the same <i>day</i> . You can set this timer for a program that comes on once a week.
Daily	Works on Monday through Sunday on the same <i>channel</i> at the same <i>time</i> each day. You can set this timer for a program that comes on every day.
Mo.-Fr.	Works on Monday through Friday on the same <i>channel</i> at the same <i>time</i> each day. You can set this timer for a program that comes on every weekday.

Tip: Want to make sure you never miss an episode of your favorite show? Just set a Weekly Event Timer once, and the receiver will automatically record it every week!

Tip: You can also press the **SELECT** button to see more information about the event timer.

Tip: Quick Record is the fastest and easiest way to record one program once. Just find the program you want to record, press **RECORD** and then you're done. It's that simple!

When an Event Timer Works

Only during the five minutes right before an event timer works, you'll see a small picture of a clock blinking on the TV screen. This clock goes away when the program begins. While you see the clock, you can do *either* one of the following:

- Press the remote control **CANCEL** button to clear the clock from the TV screen. This *doesn't* change the timer; it will still work.
- Press the remote control **INFO** button to see more information on the event timer. If you do this, you'll have these two choices:
 - Select the **OK** option to *continue* with the event timer, or
 - Select the **Stop Timer** option to stop the event timer.

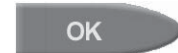

Use Quick Record

You can use *Quick Record* to very quickly set a one-time, one-program *DVR Event Timer* or *VCR Event Timer*.

1. Highlight *but don't select* a future program in the **Browse Banner**, in the **Program Guide** or in a **Themes** list.

Note: If you select a future program, you open a menu where you can set an automatic event timer. This is almost as fast as *Quick Record*.

2. Press the **RECORD** button.
3. This opens a menu where you can set an event timer.

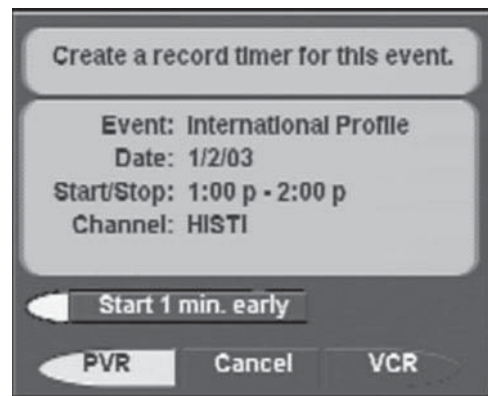

4. If you want to start the timer one minute early, select the **Start 1 min. early** option.



Note: This lets you make sure the timer records a program's start.

Note: You can start *any* timer (except one for a pay per view program) one minute early. But, if you set a timer that works right after another timer and the second one *starts* early, the first one will *end* early.

5. Select the **DVR** or **VCR** option.

Set an Automatic Event Timer

1. *Highlight and select* a future program in the **Browse Banner**, in the **Program Guide**, or in a **Themes** list.
This opens the **Create an Event Timer** menu.

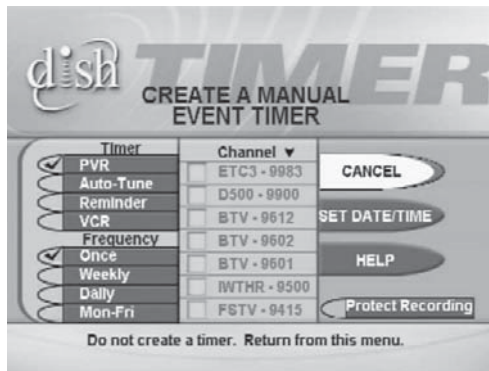

2. Select a **Timer Type** option. A check mark shows up next to the option you select. For example, here we selected the **DVR** option.
3. Select a **Timer Frequency** option. A check mark shows up next to the option you select. For example, here we selected the **Once** option.
4. Only for a Once (one-time), DVR Event Timer, you can select the **Protect Recording** check box. If you do this, a check mark shows up in the box.

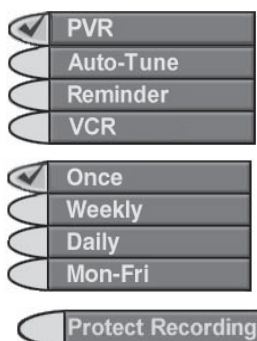

Note: When you protect a recorded program, the receiver will ask you *before* it records over that program.

5. Select the **Create** option to set the event timer. You'll see a clock picture on the program in the **Program Guide**, and also when you press the **INFO** button to get information about the program.

Tip: You can protect any recording so that the receiver will not record over it without asking you first. Just select **Protect Recording** on the **Create an Event Timer** menu.

Set a Manual Event Timer

Use a manual event timer to manually set the start and stop time of a recording. This is useful for recording all of a sports event, even if it goes into overtime. Or, you can record part of a program, or several programs one after the other.

Notes:

- *Before* you set a manual timer, use the **Program Guide** or program lists to find the start and end times you want to set.
- You *can't* set a manual timer for a pay per view program.
- You *must* set the end time *after* the start time, and set the end time at least one minute later than the start time.

Here's what to do:

1. Press the MENU button.

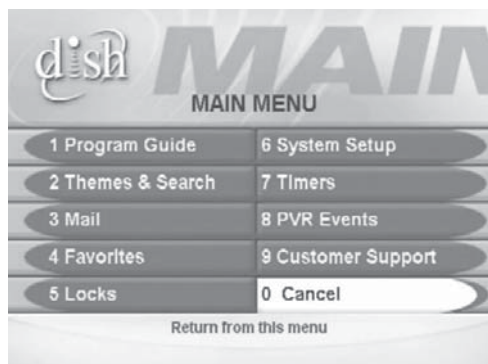

2. Select the **Timers** option.

This opens the **Event Timer Management** menu.



3. Select the **Create** option.



This opens the **Create a Manual Event Timer** menu.

Tip: You can use Event Timers to record programs automatically, or you can set a manual event timer to record several programs that are on one after another on the same channel.

4. Select a **Timer Type** option. A check mark shows up next to the option you select. For example, here we selected the **DVR** option.



5. Select a **Timer Frequency** option. A check mark shows up next to the option you select. For example, here we selected the **Once** option.

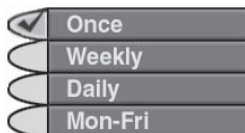

6. Select a channel:
Either: Use the UP or DOWN ARROW button to highlight a channel. Then, press the SELECT button.
Or: Use the number buttons to enter a channel number.

7. Only for a Once (one-time), DVR Event Timer, you can select the **Protect Recording** check box. If you do this, a check mark shows up in the box.

Note: If you want to delete a protected program, the receiver will ask you if you are sure you want to delete the event.

8. Select the **Set Date/Time** option.

This opens the **Set Date/Time for Manual Timer** menu.

9. Use the number buttons to enter the **Start Time** (make sure you select **AM** or **PM**) and the **End Time**, (make sure you select **AM** or **PM**). **Note:** The menu displays zeroes for you in numbers like “07”.

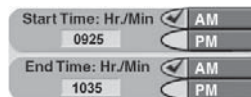

10. Use the number buttons to enter the **Date**.



11. Select the **Create Timer** option.
 12. **Either:** To set another event timer, select the **Create** option again.
Or: If you don't want to set another event timer, press the CANCEL button.

When Event Timers Overlap

If you try to set event timers for programs on at the same time and date, the receiver displays a conflict menu with the dates and times of both programs. To resolve the conflict, pick which timer to keep and which timer to delete.

Note: The receiver deletes one-time event timers right after they work. You *must* delete all other types of timers yourself.

Tip: You can use a Manual Event Timer to record a “block” of programs on the same channel, or to make sure you don't miss the last few minutes of a sports event that goes into overtime.

Edit an Event Timer

- You can edit *any* type of event timer.
- You can change *any* feature of an event timer.
- When you edit an *automatic* event timer you *change* it to a *manual* event timer. A manual timer works at the times *you* set, which *don't* have to be the actual program times.
- You can change one type of event timer to any other type of event timer and back, *within the limits on each type of timer*. Each type of timer has its own limits, so please be careful! Also, you *can't* change a *manual* timer to an *automatic* timer.

Here's what to do:

1. Press the MENU button.
2. Select the **Timers** option.



This opens the **Event Timer Management** menu.

3. Select the event timer you want to edit. A check mark shows up in the box next to the event timer. *For example*, here we selected a DVR event timer.



4. Select the **Edit** option.



This opens the **Edit a Manual Event Timer** menu.

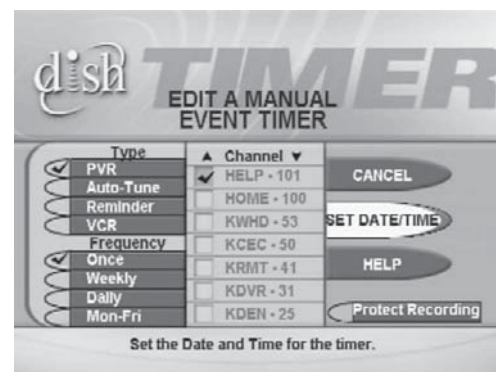

5. You can change the **Timer Type**, **Timer Frequency**, or **Channel**. To do this, select each option you want.
6. Only for a Once (one-time), DVR Event Timer, you can select the **Protect Recording** check box. If you do this, a check mark shows up in the box.



Note: When you protect a recorded program, the receiver will ask you *before* it records over that program.

- If you want to change the **Start Time**, the **End Time**, or the **Date**, select the **Set Date/Time** option. This opens the **Set Date/Time for Manual Timer** menu.



Note: If you don't want to change the date or time, please skip to step 10.

- Use the number buttons to enter the **Start Time** (make sure you select **AM** or **PM**) and the **End Time**, (make sure you select **AM** or **PM**).

Note: The menu displays zeroes for you in numbers like "0925".

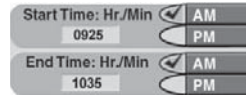

- Use the number buttons to enter the **Date**.

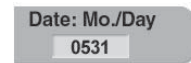

- Select the **Create Timer** option.
- Either:** To edit another event timer, highlight the timer and select the **Edit** option again.

Or: If you don't want to edit another event timer, press the **CANCEL** button.

Delete an Event Timer

- Press the **MENU** button.



- Select the **Timers** option to open the **Event Timer Management** Menu.



Tip: You must buy a Pay Per View event before you can set an automatic event timer for it. And you cannot set a manual event timer for any Pay Per View event.

3. Select an event timer you want to delete. A check mark shows up in the box next to the event timer. *For example*, here we selected a DVR event timer.
4. Select any other timer(s) you want to delete.
5. Select the **Delete** option to delete the timer(s) you selected.

Pay Per View Programs and Locked Programs

- You must buy a pay per view program before you can set an automatic event timer for it. You can't set a manual event timer for a pay per view program. You can't edit an event timer for a pay per view program.
- When you've locked the receiver, you *must* enter the password before you can set an automatic event timer for a locked program. You can set a manual event timer for a locked program and *not* enter the password. If you do set a timer like this, when the timer works the receiver may display *only* an error message or a password entry menu. If you've set a *DVR Event Timer* or a *VCR Event Timer*, the recording will show *only* the error message or password menu.
- If you use a *DVR Event Timer* to record a locked program, you must enter the password to play back the program. If you record a block of two or more programs and just one of them is locked, you must enter the password to play back any of them. For example, if you set an event timer to record a block of three programs and one of them is an adult movie, you must enter the password to watch any of the three programs.

Power Off and Event Timers

- If the receiver is off when a *DVR Event Timer*, *Auto-Tune Event Timer*, or *VCR Event Timer* works, the receiver will turn on. When the program ends, the receiver will turn off unless you press any remote control or front panel buttons while the timer is in operation.
- If the receiver is off when a *Reminder Event Timer* starts, the receiver will turn on and stay on.

How Many Event Timers You Can Set

You can set a limited number of event timers. If you try to set more, the receiver displays a menu where you can delete an existing timer. If you don't delete an existing timer, you *won't* be able to set any new ones.

Control a VCR

Note: Remember, you can use the DishDVR features to record a program *without* a VCR!

- To use *VCR Event Timers*, you *must* connect the receiver's back panel audio/video outputs to the audio/video inputs on the VCR. See page 29 for the recommended connection to a VCR.

- To use *VCR Event Timers*, you *must* set up the receiver to control the VCR (see below). If the receiver *can't* control the VCR, use an *Auto-Tune Event Timer* to tune the receiver to the channel you want to record. Use the timers built into the VCR to start and stop the VCR at the right times.
- The receiver's front panel IR BLASTER sends an IR signal to control the VCR. This signal can bounce off walls or other objects on its way to the VCR. This works in most home setups. But, shelves or smoked glass doors between the receiver and the VCR can block the signal. If the signal has to cross a very large room, or bounce off curtains, it may not be strong enough to control the VCR. Make sure nothing blocks the signal, and the signal can bounce off nearby, light-colored, smooth surfaces.
- If you can't set up the IR BLASTER to control the VCR, maybe you can use an IR extender you connect to the receiver ACCESSORY JACK. An IR extender is a cable that carries the infrared signal from the receiver to the IR sensor on the VCR. You can buy extenders from the Customer Service Center. You *must* set up the receiver to send the right signals out via the ACCESSORY JACK. Please see *Set Up the Accessory Jack* on page 81.



Here's what to do:



The receiver *starts* the VCR to record, but *doesn't* turn the VCR on. So, you *must* leave the VCR turned on!

1. Get the VCR device code from the table in *Device Codes* starting on page 121.
2. Press the MENU button.
3. Select the **System Setup** option.
4. Select the **Installation** option.
5. Select the **VCR Setup** option.
6. Use the number buttons to enter the VCR device code.
7. Make sure you turn on the VCR. If you are using the **TV Set Out** on the receiver to provide audio/video to the VCR, set its channel switch to 3 or 4 to match the receiver back panel channel 3/4 switch and make sure the VCR is set to record on this channel. Put in a rewind videotape that you can record on.



- To test the device code, highlight the **Test** option. The receiver displays a message that warns you to make sure you turn the VCR on. 
- Press the **SELECT** button to start the test. The VCR records for a few seconds, stops, and then rewinds.
- The receiver displays a message that says the VCR test is done. Do what the message says. If the VCR did not do the test, enter another device code from the table, and then do step 8, step 9, and this step *again*.
- Once you find the right VCR code, select the **Save** option to save the VCR code you entered. 
- Set the *VCR Event Timer(s)* you want. Remember, you must leave the VCR turned on with a blank tape inserted ready to record.

Use Caller ID

Caller ID displays on your TV the names of people as they call you if you subscribe to Caller ID from your local phone company.

Enable Caller ID

- Make sure you have an active phone line connected to the DishDVR receiver.
- Make sure your system is properly grounded. Sometimes an improperly grounded system will cause problems with the **Caller ID** feature.
- Press **MENU** on the remote and select **System Setup, Installation**, and then **Caller ID**, or press MENU-6-1-8 on the remote.

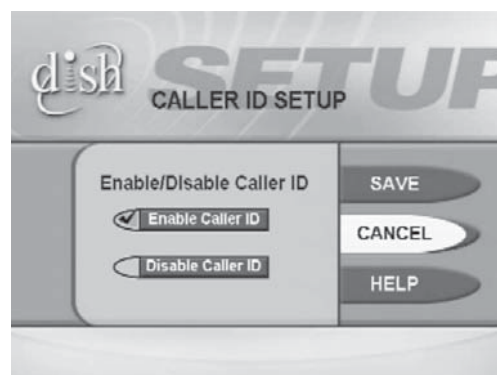

- When the **Caller ID** menu opens, move the highlight to **Enable** and press **SELECT** to save your choice. Press **VIEW** to go back to watching a program.

When You Get a Call

When you receive a call, you will see a **Caller ID** popup with the same kind of information you see on your regular phone or Caller ID device.



You can select **OK** to close the message. If you do nothing, it will disappear after 20 seconds.

If you are in a menu when a call comes in, you will see a different **Caller ID** popup screen.



Use Dolby® Digital Sound

Dolby® Digital lets you use Dolby® Surround sound in an audio/video system. The receiver has a Dolby® Digital output, although *not* all programs have Dolby® Digital sound. The receiver provides Dolby® Digital and Linear PCM (regular mono or stereo sound) for a sound system or audio amplifier/decoder that can process such audio.

1. Connect an amplifier/decoder that can process Dolby® Digital signals to the receiver's back panel DOLBY® DIGITAL output.
2. Press the MENU button.
3. Select the **System Setup** option.



4. Select the **Dolby® Digital** option.
5. Select one of the options below.

tuv



If you select the **Dolby® Digital/PCM** option and the amplifier can't process both types of signals, you could damage the speakers. Please see the user's manual that came with your amplifier for more details.

- **Dolby® Digital Only** - Select this option if the amplifier can process *only* Dolby® Digital (AC3) signals.
 - **PCM Only** - Select this option *only* if the amplifier *can't* process Dolby Digital signals.
 - **Dolby® Digital/PCM** - Select this option *only* if the amplifier can process *both* Dolby® Digital and Linear PCM signals.
6. Select the **Save** option to save the setup.

Use the DishDVR Features



Most satellite TV programs and films are copyrighted. In some cases, copyright law may apply to private, in-home recording.

The DishDVR features let *you* decide how to watch TV. You can pause, reverse, or skip back through a program. Then you can go back to watch, fast forward, or skip ahead through the programed can *record* and *play back* programs with full digital audio and video quality, *without* a VCR.

Auto Recording

If you get a phone call while you watch a live program, you can pause the program, answer the phone, go back to watch the program, and not miss *any* of the action.

You can pause, reverse, or skip back through a live program. Then you can go back to watch, fast forward, or skip ahead through the program.

You can also use slow motion forward and backward, and frame advance and reverse while using the DishDVR's auto recording feature.

For more information, please see *Use Auto Recording*, below.

On-Demand Recording

You can record a program on now or a future program to watch later, or you can keep your recording.

You can pause, go back to play, reverse, skip back, fast forward, or skip ahead through a recorded program.

You can also use slow motion forward and backward, and frame advance and reverse while using the DishDVR's auto recording feature.

You can play back a program you already recorded and record a new program at the *same* time.

For more information, see page 62.

Auto Recording and On-Demand Recording at the Same Time

You can pause, go back to watch, reverse, skip back through, fast forward, or skip ahead through a "live" program and record that program at the same time. For more information, see page 66.

Use Auto Recording

Turn the receiver on and tune it to a channel. Then you can use the remote control's DishDVR buttons.

Note: When you press any one of these buttons, you'll see a small sign on the TV screen.

Press the PAUSE button to pause the program. Press this button *again* to watch the program from where it paused.



Note: For a "live" program, the on-screen pause timer shows how long you've paused the program. If you've paused the program more than once, the pause timer shows the *total* time you've paused. If you pause after you reverse or forward, the pause timer shows how far you're behind the "live" program.

Press the BACK button *once* to reverse the program four times as fast as normal play. Press the BACK button *twice* to reverse at 15 times normal speed, *three times* to reverse at 60 times normal speed, and *four times* to reverse at 300 times normal speed. The on-screen bar shows how far you've gone.



Press the PAUSE button and then press the BACK button to reverse the program in slow motion. Press the BACK button *once* to reverse the program 1/4 the speed as normal play. Press the BACK button *twice* to reverse at normal speed.

Press the FWD ("FORWARD") button *once* to forward the program four times as fast as normal play. Press the FWD button *twice* to forward at 15 times normal speed, *three times* to forward at 60 times normal speed, and *four times* to forward at 300 times normal speed. The on-screen bar shows how far you've gone.



Tip: Auto recording is what happens automatically while you're watching a program. It includes features like Pause, Back, Forward and Skip Forward. On-demand recording is what you use with programs you've already recorded.

Press the PAUSE button and then press the FWD button to forward the program in slow motion. When you press the FWD button once the program advances at 1/15 the speed of normal play. Press the FWD button twice to forward at 1/4 as fast as normal play. Press the FWD button three times to play the program.

Note: Of course, you *can't* "forward" into the part of a "live" program that hasn't been broadcast yet.

Press the PLAY button to watch the program. Also, press this button to switch from pause, forward, or reverse to play.



Press the SKIP BACK button to skip back about ten seconds in a recorded program. Press this button *again* to skip back again.



Press the PAUSE button and then press the skip back button to reverse the recording one frame at a time.

Press the SKIP AHEAD button to skip ahead about 30 seconds in the program. Press this button again to skip ahead again.



Press the PAUSE button and then press SKIP AHEAD to advance the recording one frame at time.

Note: Of course, you can't "forward" into the part of a "live" program that hasn't been broadcast yet.

Press the VIEW button to catch up with the program as it's showing now.



Use On-Demand Recording

Turn the receiver on and tune it to a channel.

Note: If you record a locked program while you have the receiver locked, you'll have to enter the password to play back that program.

Start Recording a Program

- *At a program's start*, press the remote control's RECORD button.
If you've watched a program from its start, up to about one hour after it's started, you can reverse to its start:



1. Press the BACK button.
2. Let the program reverse to its start.
3. Press the RECORD button.
You'll get *all* of the program on your recording.



Note: If you don't tune to a program until *after* it starts, you can record *only* the part of the program that comes *after* you tune to it.



Stop Recording a Program

- Press the remote control's STOP button.



When you press the RECORD button, *you* control how long the receiver records. The receiver *won't* stop recording too soon. This also means *you must* remember to stop the recording! You can use an *Event Timer* to start and stop the recording:



- Use *Quick Record* to set a one-time DVR event timer for a future program. Please see page 50.
- Set an *automatic* DVR event timer to record a future program that comes on each day or each week. Please see page 51.
- Set a *manual* DVR event timer to make a future recording with start and stop times you set. This lets you record part of a program or a block of several programs, one after the other. See page 52.

Use the DVR Recorded Events Menu

Press the DVR button to open the **DishDVR Recorded Events** menu.







- “Events” are recorded programs or other recordings you make.
- If you hide adult channels and lock the receiver, this menu doesn't list any adult programs by name.
- To review programs you record *only* with the DishDVR features, use this menu. To see *all* event timers, *including* DishDVR timers, use the **Event Timer Management** menu.

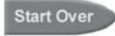

The **DishDVR Recorded Events** menu shows you:

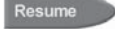
- A list of recorded events that includes the one you're recording now, if any.
Note: You can sort events either by date or the name of the event.
- Approximately how much time you can still record. We call this the “time left.”
Note: The receiver needs more room to record programs with more action. So, the “time left” *isn't* exact.
- **If you select any one of the events on the DishDVR Recorded Events menu** (even an event you're recording), you open an **information menu** for that event.
Note: This is just an example of the information menu. The information menu shows *only* the options for the event you select. For a different event, you'll see different options. You'll see some (not all) of the options we list below. You won't see an option to start recording; to do that, you must press the remote control RECORD button or set an event timer.
Note: If you record a locked program while you have the receiver locked, you'll have to enter the password to play back that program.

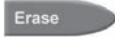

Tip: Press DVR on the remote to see a list of the events you've recorded. To view one of these events, just Select it. You can then Start the recording, Start Over, Stop or Resume play.

- Select the **Start** option to play back the event from its start. 
- Select the **Start Over** option to play back the event from its start. 
- Select the **Stop** option to stop play back and go back to the event's information menu. 
- Select the **Resume** option to play back the event from where you stopped it before, if ever. 
- Select the **Protect** option to "protect" the event. The receiver will ask you *before* it records over the event. 
- Select the **Unprotect** option to "unprotect" the event. 

Note: To unprotect an event or to erase a protected event when you've locked the receiver, you *must* enter the password.

- Select the **Erase** option to erase the event. 
- Select the **View** option to go back to the last satellite TV channel you watched. If you're recording an event, the receiver tunes to that event's channel. 
- Select the **Cancel** option to go back to the **DishDVR Recorded Events** menu. 

While Playing Back or Recording an Event

- Press the **PAUSE** button to pause the play back. Press this button *again* to go on with the play back. 
 - Press the **BACK** button *once* to reverse the program four times as fast as normal play. Press the **BACK** button *twice* to reverse at 15 times normal speed, *three times* to reverse at 60 times normal speed, and *four times* to reverse at 300 times normal speed. 
 - Press the **PAUSE** button and then press the **BACK** button to reverse the program in slow motion. Press the **BACK** button once to reverse the program 1/4 the speed as normal play. Press the **BACK** button twice to reverse at normal speed.
 - Press the **FWD** ("FORWARD") button *once* to forward the program four times as fast as normal play. Press the **FWD** button *twice* to forward at 15 times normal speed, *three times* to forward at 60 times normal speed, and *four times* to forward at 300 times normal speed. 
 - Press the **PAUSE** button and then press the **FWD** button to forward the program in slow motion. When you press the **FWD** button once the program advances at 1/15 the speed of normal play. Press the **FWD** button twice to forward at 1/4 as fast as normal play. Press the **FWD** button three times to play the program.
- Note:** Of course, you can watch *any* part of an event you've already recorded.

- Press the **PLAY** button to play back or go on with a paused play back. Also, press this button to switch from fast forward or reverse back to normal play back.
- Press the **SKIP BACK** button to skip back about ten seconds in the event. Press this button *again* to skip back again.
- Press the **PAUSE** button and then press the **SKIP BACK** button to reverse the recording one frame at a time.
- Press the **SKIP AHEAD** button to skip ahead about 30 seconds in the event. Press this button *again* to skip ahead again.
- Press the **PAUSE** button and then press the **SKIP AHEAD** button to advance the recording one frame at a time.
- Press the **STOP** button to stop play back.



Play Back a Recorded Event and Record Another Event

1. Set up the receiver to make an on-demand recording.

Note: You can press the **RECORD** button or you can use any kind of event timer *except* a VCR event timer.

2. Press the **DVR** button. This opens the **DVR Recorded Events** menu.



3. Select an event on the **DishDVR Recorded Events** menu (*not* the one you're recording). This opens an information menu for that event.
4. Select the **Start**, **Start Over**, or **Resume** option to play back the event.

Tip: With the DishDVR receiver, you can even watch one recorded event while recording another at the same time!

More About the DVR Features

Auto Recording

- *Whenever* you turn the receiver on, it's auto recording.
- With auto record, you can record up to *about* an hour of a program. This total recording time applies to auto recording only.
- The receiver needs more room to record programs with more action. So, the total recording time *isn't* exact.
- After *about* an hour, the receiver starts to *record over* its oldest audio and video to have room for new audio and video.
- If one program ends and the next one starts on the *same* channel, the receiver continues to record the next program.
- If you *change* the channel, you *erase* the recorded audio and video, and start recording the new channel.

On-Demand Recording

- On-demand recording works *only* when you set it up.
- The receiver *must* have enough room to record:
 - When you make a one-time DishDVR recording, you can set the receiver to ask you *before* it records over what you record. This is how you "protect" a recorded event.
 - If the receiver needs room to record a new event, it'll *record over* the oldest "unprotected" recorded event(s) to make room.
 - If the receiver is out of room, and you don't let it record over any old recorded events, it *won't* be able to record a new event.
 - To free up space on the receiver, you can erase events by opening the **Events Information** menu and selecting the **Erase** option.

Auto and On-Demand Record at the Same Time

If you record a live program using the on-demand option, you can use auto recording to pause, go back to play, reverse, skip back through, fast forward, or skip ahead through the *same* program at the *same* time.

Copy Recordings to Videotape



You may want to keep a videotape copy of a recording you made on the DishDVR. Or, if the receiver is out of room, maybe you'll want to move recordings to a videotape to store them.



Many satellite TV programs and films are copyrighted. In some cases, copyright law may apply to private, in-home recording.

You will *not* be able to play back events with full digital audio and video quality from a videotape.

Here's what to do:

1. Connect the receiver's back panel audio/video outputs to the VCR's audio/video inputs.
2. Put a rewind tape into the VCR.
3. Turn the VCR on.
4. Press the remote control DVR button. This opens the **DishDVR Recorded Events** menu. 
5. Select an event on the **DishDVR Recorded Events** menu. This opens an information menu for that event.
6. Start the VCR to record onto the tape.
7. On the event's information menu, select the **Start** option. The receiver begins to play back the event. 
8. When the play back is done, **either**: Select another event to copy, **or**: If you don't have another copy to make, stop the VCR.

Tip: If you want to "archive" an event to save it for a long time, you can move it from the receiver to a VCR.

Control Other Devices with the Remote

This section describes how to use the remote to control a TV, a VCR, or other devices. For information on how to use the remote to control the receiver, see *Remote Control* on page 20. You can set up the remote to control the satellite TV receiver and up three other devices. These devices can be a TV, a VCR or DVD player, and a third device.

Remote Control Modes

You can set the remote to four different modes to control the receiver or other devices.

You *must* set up the remote to control a device like a TV or a VCR. See *Set Up the Remote to Control Other Devices*, below.

Use the remote control's mode buttons, **SAT** (satellite receiver), **TV**, **VCR** (for a VCR or a DVD player), and **AUX** ("auxiliary," for a cable TV box, a tuner, or an audio amplifier) to *set* the remote to the right mode for the device. To *change* the mode, press the button for the device you want the remote to control. The mode button lights for two seconds to show you've set the remote to that mode.



Limited Mode

You can program your remote control in limited mode to keep from accidentally changing the channel on your TV or VCR. When you use the remote to control your TV in limited mode, you will only be able to use the **POWER**, **MUTE**, and **VOLUME** buttons. Also, when you use the remote to control your VCR in limited mode, you will only be able to use the **POWER** and **VCR** tape control buttons.

The section *Set Up the Remote Control* has a step that tells the remote control to go into limited mode.

Note: Limited mode is not used with cable boxes or amplifiers.

Set Up the Remote to Control Other Devices

Over the next few pages we tell you how to use the remote to control a TV, a VCR, a cable TV box, a tuner, or an amplifier.



When you get the remote it's already set up to control the receiver. But, you *must* set up the remote to control the TV *before* you can control the TV's **POWER**, **MUTE**, and **VOLUME** buttons.

To use the remote to control other devices, you must first program it to control these other devices. You can do this by either following the instruction in *Set Up the Remote Control* below, or *Scan for Device Codes* procedure described on page 70.

Set Up the Remote Control

You can set up the remote to control other devices using the device codes listed on page 120.

1. Turn the device on. Use the device's front panel buttons or its remote control.
2. Find the brand name of the device in the tables starting on page 120. If the brand isn't listed, see *Scan for Device Codes* on page 70.
3. Press and hold the mode button until all the other mode buttons light up, and then let go of the button. For example, hold the TV mode button for a TV until all of the other mode buttons light. When you let go, the TV mode light will flash.
The mode button flashes.
4. *For AUX mode only.* Press 0 for a second TV, or 1 for a second VCR, or 2 for a tuner, amplifier, or cable box. This step is for programming which kind of device that should be programmed in AUX mode. If you're not programming in AUX mode, skip to step 5.
5. Enter one of the three-digit device codes from the table using the number buttons. The three-digit device code should be for the brand name of your device that you found in step 2.
6. If you want to program limited mode, press 1. If not, skip to step 7. See *Limited Mode* for more information.
7. Press the POUND (#) button. If you entered the code correctly, the mode button flashes three times.
8. Press the blank POWER button to turn off the device. If the device does not turn off, go to step 10. If the code works, the device should turn off.
9. Turn the device back on and try some other buttons to make sure they work. If the code works for other buttons, stop here. Sometimes the blank POWER button works when other buttons don't.
10. If the code doesn't work, redo steps 3 through 9 with another device code from the tables. Try every code listed for you brand until one works for your device.
11. If you can't find a code that works try, *Scan for Device Codes* below.

Tip: The receiver deletes one-time event timers right after they work. You must delete all other types of timers yourself.

Scan for Device Codes

If the code for your device is not listed in the tables starting on page 120, use this procedure to scan the remote control's memory for the device code.

1. Turn the device on. Use the device's front panel buttons or its remote control.
2. Press and hold the mode button until all the other mode buttons light up, and then let go of the button. For example, hold the TV mode button for a TV until all of the other mode buttons light. When you let go, the TV mode light will flash.
The mode button flashes.
3. *For AUX mode only.* Press 0 for a second TV, or 1 for a second VCR, or 2 for a tuner, amplifier, or cable box. Then press the STAR (*) button. This step is for programming which kind of device that should be programmed in AUX mode. If you're not programming in AUX mode, skip to step 4.
4. Press the blank POWER button. This puts your remote in the scan mode.
5. Press the UP or DOWN ARROW button repeatedly until the device turns off. As you press the UP or DOWN ARROW button, the remote is trying each code in the memory to see if it can turn off your device. When the device turns off, you have found a code that might work.
Note: The mode button for the device will flash rapidly eight times when you've scanned all the codes for that device.
6. Press the Pound (#) button. This stores the code you found.
7. Turn the device back on and try some other buttons to make sure they work. Press the blank POWER button to turn the device back on. Try some other buttons to make sure they work. Sometimes, the blank POWER button works when other buttons don't.
8. Repeat this procedure until you've tried all the codes. You may need to repeat the scan to find the best code for your device.

Check the Device Codes

You can find out what device code you've set for each remote control mode.

1. Press and hold the mode button until all the other mode buttons light up, and then let go of the button.

The mode button flashes.

For example, hold the TV mode button for a TV until all of the other mode buttons light. When you let go, the TV mode light will flash.
2. Press the Pound (#) button twice.

Watch the mode light to determine your code. The mode button flashes the number for each digit of the device code, with a pause between the groups of flashes. A quick flash is for zero.

For example, if the code is 570, the mode button flashes five times, pauses, flashes seven times, pauses, and flashes once quickly.
3. For AUX mode only. The first group of flashes tells you what the AUX mode controls. A quick flash (zero) before the three-digit code is for a TV; one regular flash is for a VCR; and two flashes is for a tuner, amplifier, or cable box.

For example, if the TV code is 570, the AUX mode button flashes once quickly (indicating 0 for TV), pauses, flashes five times, pauses, flashes seven times, pauses, and flashes once quickly.

Remote Control Buttons

Control the Receiver



When you get the remote it's *already* set up to control the receiver. But, you *must* set up the remote to control the TV *before* you can use the MUTE and VOLUME buttons.

For information on the remote buttons that control the receiver, please see *Remote Control* on page 20.

Control a TV (or a Second TV)



Only the buttons described here control a TV. Some of the buttons described here may *not* control your TV. Please see your TV user's manual for information about the TV's features.

TV Mode Button

You *must first* set up the remote to control the TV. Please see *Set Up the Remote to Control Other Devices*, beginning on page 68. Then, you *must* press the TV mode button to set the remote to TV mode. The TV mode button lights for two seconds to show you've set the remote to TV mode. Make sure you keep the remote in TV mode to use the buttons described here.

Note: You can set up the remote to control a second TV in AUX mode, the same way it controls the first TV in TV mode. See *Set Up the Remote to Control Devices* beginning on page 68.



TV/Video Button

If the TV has video input options, use this button to switch the TV video input.

TV/VIDEO



Power Buttons

Press either POWER button to turn the TV on or off.

Note: If you set up the remote to control one TV in TV mode and an additional TV in AUX mode, pressing the TV POWER button controls only the TV you set up in TV mode.

POWER



Mute Button

Press this button to turn the TV sound on or off.

MUTE



Volume Button

Press this button to raise (+) or lower (-) the TV sound volume.

VOLUME



Tip: If you set up the remote to control a TV, the TV POWER, MUTE, and VOLUME buttons will control the TV volume when you're in most other modes.

Up/Down Arrow Buttons

Use these buttons to change channels on the TV.

Note: These buttons do not change the channels on the TV if the remote control is in limited mode.



Select Button

The SELECT button works as the ENTER button for a TV.



Recall Button

Press this button to go back to the last TV channel you watched. Press it again to switch between the last two TV channels you watched.



Number Buttons

Use these buttons to directly enter a different channel.

Note: These buttons do not change the channels on the TV if the remote control is in limited mode.



Control a VCR (or a Second VCR or a DVD Player)



Only the buttons described here control a VCR or DVD player. Some of the buttons described here may *not* control your VCR or DVD player. See the user's manual that came with your VCR or DVD player for information about the features.

VCR Mode Button



You *must first* set up the remote to control the VCR. See *Set Up the Remote to Control Devices*, beginning on page 68. Then, you *must* press the VCR mode button to set the remote to VCR mode. The VCR mode button lights for two seconds to show you've set the remote to VCR mode. Make sure you keep the remote in VCR mode to use the buttons described here.

Note: You can set up the remote to control a second VCR in AUX mode, the same way it controls the first VCR in VCR mode. See *Set Up the Remote to Control Devices* beginning on page 68.

Note: You *must* set the remote to VCR mode to set it up to control a DVD player. Once you do this, you *must* set the remote to VCR mode to control a DVD player.

TV/Video Button

Use this button to switch the VCR between its TV mode and its VCR mode (see your VCR user's manual for information).

TV/VIDEO



Power Button

Press the blank Power button to turn the VCR on or off. Press the TV power button to turn the TV on or off.

POWER



Mute Button

Press this button to turn the TV sound off or on.

MUTE



Up/Down Arrow Buttons

Use these buttons to change channels on the VCR.

Note: If you are using the remote control in Limited Mode, the TV will not change channels.



Recall Button

Press this button to go back to the last VCR channel you used. Press it again to switch between the last two VCR channels you used.



RECALL

VCR Buttons

- Press the **BACK** button to rewind a videotape.
- Press the **PAUSE** button to pause a videotape. Press this button or the **PLAY** button to go back to play the tape.
- Press the **FWD** (“forward”) button to forward a videotape.
- Press the **STOP** button to stop playing or recording on a videotape.
- Press the **RECORD** button to record on a videotape.
- Press the **PLAY** button to play or to go back to play a videotape.



BACK



PAUSE



FWD



STOP



RECORD



PLAY

Number Buttons

Use these buttons to enter channel numbers.

Note: If you are using the remote control in Limited Mode, the TV will not change channels.



Control a Cable TV Box



Only the buttons described here control a cable TV box. Some of the buttons described here may *not* control your cable TV box. Please see your cable box user's manual for information about the box's features.

AUX Mode Button



You *must* first set up the remote to control the cable TV box. Please see *Set Up the Remote to Control Devices*, beginning on page 68. Then, you *must* press the AUX mode button to set the remote to AUX mode. The AUX mode button lights for two seconds to show you've set the remote to AUX mode. Make sure you keep the remote in AUX mode to use the buttons described here.

TV/Video Button



Use this button to switch the cable box between its TV mode and its video mode.

Power Button

Press the blank POWER button to turn the cable box on or off.



Mute Button

Press this button to turn on or off the sound from the cable box.



Volume Button

Press this button to raise (+) or lower (-) the sound volume from the cable box.



Up/Down Buttons

Use these buttons to change channels on the cable box.



Select Button

Press the Select button in place of the ENTER button for the cable box.



Recall Button

Press this button to go back to the last cable box channel you used. Press it again to switch between the last two cable box channels you used.



Number Buttons

Use these buttons to enter channel numbers.

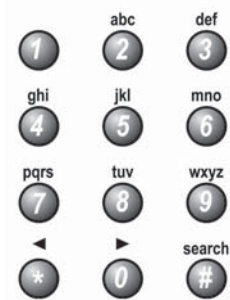

Control a Tuner or Amplifier



Only the buttons described here control a tuner or amplifier. Some of the buttons described here may *not* control your tuner or amplifier. Please see the user's manual that came with your tuner or amplifier for more information.

AUX Mode Button

You *must* first set up the remote to control the device. See *Set Up the Remote to Control Devices*, beginning on page 68. Then, you *must* press the AUX mode button to set the remote to AUX mode. The AUX mode button flashes once to show you've set the remote to AUX mode. Make sure you keep the remote in AUX mode to use the buttons described here.



Power Button

Press the blank POWER button to turn the tuner or amplifier on or off. Press the TV power button to turn the TV on or off



Mute Button

Press this button to turn the sound off or on.



Volume Button

Press this button to raise (+) or lower (-) the volume.



Up/Down Arrow Buttons

Use these buttons to change channels on the tuner or amplifier.



Select Button

This button works as the INPUT SELECT button for the tuner or amplifier.



Other Remote Control Features



Switch Between TV and AUX Device Volume Control

When you set up the remote to control a TV, the mute and volume buttons control the TV volume. However, if you want to use the AUX mode to control a tuner or amplifier and the device has a volume setting, you can set up the remote to control the device's volume instead of the TV volume.







To set the remote to control the device's volume:

1. Press and hold the AUX mode button for three seconds, and then let go of it. The AUX mode button will blink.
2. Press the POUND (#) button.
3. Press the plus (+) side of the VOLUME button.
4. Press the 0 number button.



5. Press the POUND (#) button.
The AUX mode button flashes three times. 
6. Press the SAT mode button. 
7. Press the plus (+) and minus (-) sides of the VOLUME button.
The device's volume changes and the AUX mode button lights instead of the TV mode button.

To set the remote back to control the TV volume:

1. Press and hold the TV mode button for three seconds, and then let go of it. The TV mode button will blink. 
2. Press the POUND (#) button. 
3. Press the plus (+) side of the VOLUME button. 
4. Press the 0 number button. 
5. Press the POUND (#) button.
The TV mode button flashes three times. 
6. Press the SAT mode button. 
7. Press the plus (+) and minus (-) sides of the VOLUME button.
The TV's volume changes and the TV mode button lights instead of the AUX mode button.

Upgrade the Receiver Software

Once in a while, we may upgrade your receiver's software *for free*. You can set up the receiver to *Receive a Software Upgrade* and/or *Set Up the Receiver to Tell You About Upgrades*.

Receive a Software Upgrade

1. Make sure you turn the receiver off, so its green front panel **POWER** light is off. To do this, press the remote control's blank **POWER** button while the remote control is in **SAT** mode.
2. While the receiver is taking the upgrade, the receiver's front panel **POWER** light will blink. *Don't* disturb or unplug the receiver while the new software is downloading.

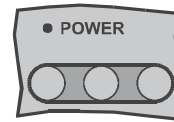

Note: The software upgrade may take up to about half an hour.

Set Up the Receiver to Tell You About Upgrades

You can set up the receiver to tell you when you can get a software upgrade; it'll ask you to let it get the software. Unless you set up the receiver to ask you, automatically download new software without asking.

1. Press the **MENU** button.
2. Select the **System Setup** option.
3. Select the **Installation** option.
4. Select the **System Upgrades** option.
5. Select the **Ask before downloading** option or the **Without my permission** option.



or:



Note: A "download" is the same as an upgrade.

6. Select the **Save** option to save your choice.



Reset the Receiver

You can reset the receiver with the setup it had when you bought it.



If you reset the receiver, you *throw away* all Favorites Lists *except* **All Chan** and **All Sub**.

If you reset a *locked* receiver, you *keep* the locks. If you reset an *unlocked* receiver, you *throw away* the locks.

If you *lock* the receiver, even resetting it *won't* bypass a lock or unlock the receiver. You *can't* reset the receiver to get rid of a password you forget.

1. Press the **MENU** button.
2. Select the **System Setup** option.
3. Select the **Installation** option.
4. Select the **Factory Defaults** option (“Factory Defaults” refers to the receiver’s original settings).
5. Select the **Yes** option to confirm the reset.



Change Program Languages

You can choose a language other than English for some programs. Some programs, like movies, show at the start if you can choose another language.

Note: You can choose another language for a program but *not* for the menus.

1. Press the **MENU** button.
2. Select the **System Setup** option.
3. Select the **Alternate Audio** option.



When you record to a VCR, the VCR records only what you see on the TV screen. If you try to play back a program and record a new program to a VCR at the same time, the VCR will record what you play back, not the new program.

- Select a language in the **Languages** list. A check mark shows up in the box next to the language. *For example*, here we selected **Spanish**.



Note: If the program is broadcast in a language that isn't listed, select the **Alternate** option to hear that language. If the program is broadcast *only* in the listed languages, select the **Alternate** option to hear English.

- Select the **Save** option to save your choice.

Set Up the Accessory Jack

If you connect a multi-dish switch to the ACCESSORY JACK, or if you use an IR extender, you *must* set up the receiver for these options.

- Press the MENU button.
- Select the **System Setup** option.
- Select the **Accessory Jack** option.
- Select the **IR Extender** option to use an IR extender. Select the **Switchbox** (multi-dish switch) option if you connect a multi-dish switch to the ACCESSORY JACK.
- Select the **Save** option.

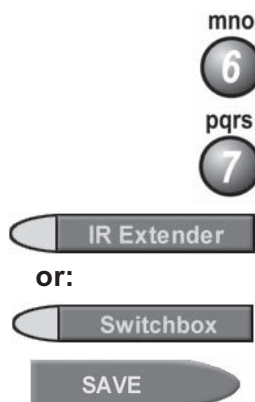

Dish Home Interactive TV Applications

Press the DISH button on your remote control to use the **Dish Home Interactive Applications**. You can order channels, check the news and weather, and even play games.



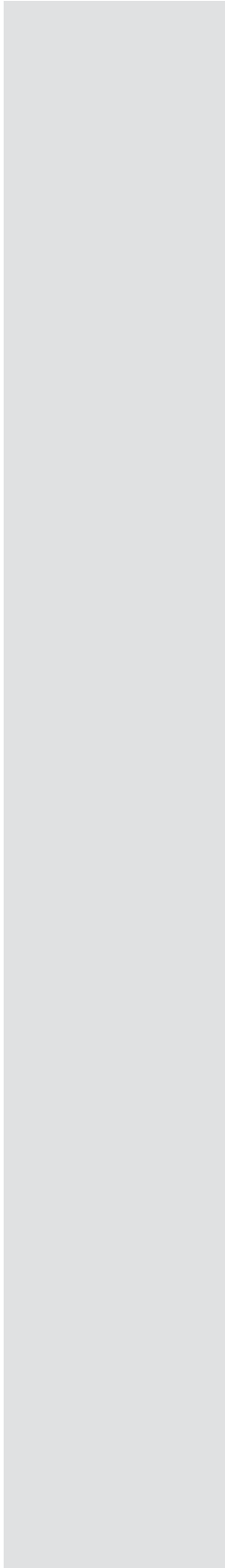

Chapter 4

Installation Instructions

How to Use these Instructions

These instructions guide you through the installation of a satellite system which includes your DishPro receiver (included with this manual), and a **DishPro** antenna system that can be identified by the DishPro logo shown below.



Note: If you have a Dish antenna system already installed, and the dish has been pointed for the strongest possible signal strength, you can skip this chapter and go directly to *Appendix A* to install the satellite receiver in an existing system.

Installing a DISH 500 Antenna

The first step in installing your dish antenna is to assemble the satellite dish, mount it, and point it in the general direction of a satellite. To do this, follow these instructions:

Finding the Satellites

You need to find the satellites in the sky. To do this, you need to know the azimuth angle (the south, southeast, or southwest direction to the satellites) and the elevation angle (the angle up to the satellites) from your location, and the skew angle.

1. Connect the **TV SET OUT** on the receiver's back panel to the television's **RF TUNER INPUT** using a coaxial cable. Make sure that the TV is tuned to the same channel as the **CHANNEL 3/4 SWITCH** on the receiver's back panel (for example, if this switch is on "3," the TV must be tune to Channel 3).

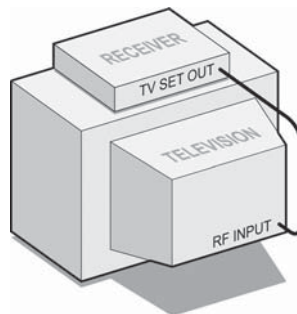

Installation Instructions

2. Make sure that the remote control batteries are fresh, and are installed properly. If needed, make sure that the remote is in SAT mode to control the satellite receiver.
3. Turn ON the television and receiver.
4. Display the **Point Dish and Signal Strength** menu by pressing MENU and then 6-1-1 (unless the receiver already displays this menu).

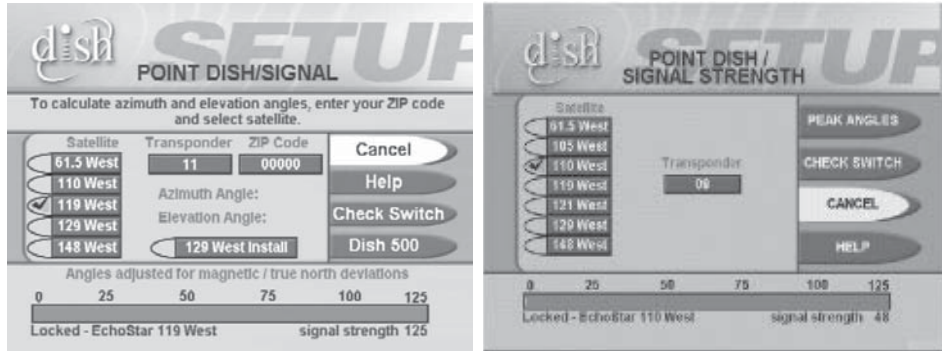

5. If your Point Dish/Signal screen looks like the one on the left, continue to step 6. If your Point Dish/Signal screen looks like the one on the right, select **Peak Angles**.
6. Enter your ZIP code in the **ZIP Code** field.
7. Select the **Dish 500** option.

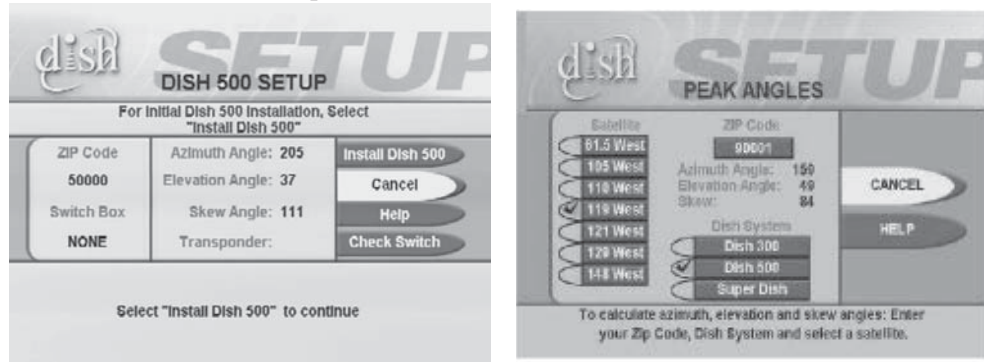

Azimuth: _____
 Elevation: _____
 Skew: _____

8. The menu displays the azimuth, elevation, and skew angles. Write down these numbers in the blanks provided in the margin.
9. Select **Cancel** to exit out of this menu and return to the **Point Dish/Signal** menu.
10. Go to *Mounting the Dish* on page 85.

Mounting the Dish

1. Using these azimuth and elevation angles, find a location for the satellite dish which can be pointed towards the satellites located at these angles. With a compass, find the required azimuth angle. Then, use the elevation angle to find out how high the satellites are in the sky from your location. Make sure nothing blocks the line of sight between the dish and the satellites.
2. Mount the mast to a solid surface so that the dish antenna cannot move or be bumped out of adjustment. Keep in mind that physical and environmental conditions can block your satellite dish's ability to receive a clear satellite signal. The conditions to be aware of are: Eaves and overhangs on your building or house, wind, plant growth, and deterioration of the mounting surface. Never mount to a tree.

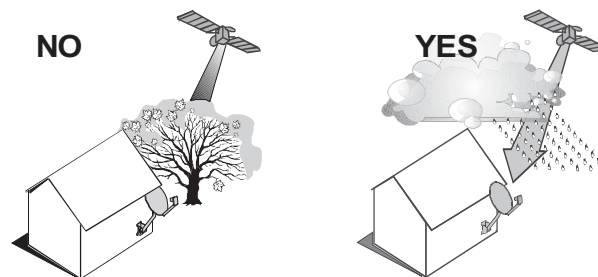

3. Align the top part of the mast so that it is absolutely vertical, as shown below. If the top part of the mast is off vertical by only a few degrees, it will be difficult or maybe even impossible for you to find the satellites. Take at least two readings with a bubble level, on the upper mast, that are 90 degrees apart from one another.

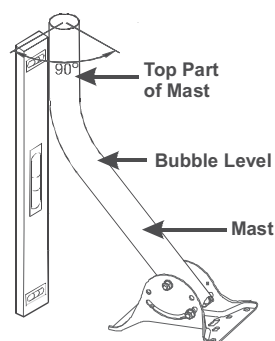

Installation Instructions

4. Assemble the satellite dish as shown below, except do not attach the Y-bracket or LNBF at this time.

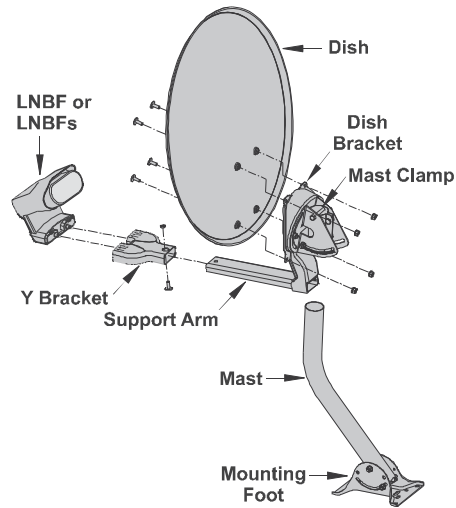

5. Loosen both skew bolts and set the skew by rotating the dish mounting bracket to align the red mark with the required angle on the skew scale which you wrote down on 84. Tighten the skew bolts securely to keep the dish from rotating. **Once the skew is set, do not try to fine-tune this angle when aiming the dish.**

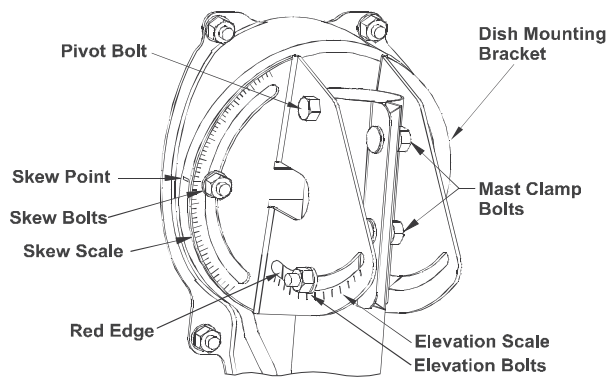

6. Set the elevation by tilting the dish mounting bracket to align the red edge with the required angle from page 84 on the elevation scale. Tighten the elevation bolts, but *do not* tighten the pivot bolt at this time.

Note: You can have as much as 200 feet of cable between the DishPro LNB and the DishPro receiver. However, you must use only RG-6 coaxial cables rated for 950 to 2150 MHz. Some cables may say "Swept tested for 2150 MHz." If you have any doubt about this, ask your DISH retailer, or look on the container the cable came in. Do not use cable company TV cables or cables from other satellite TV systems not rated for 950-2150 MHz. These other cables may cause signal loss. Do not use existing cables such as RG-59. Also, be sure that any outdoor connections are made using waterproof F-connectors.



Tighten all of the coaxial cable connection *only* by hand. If you use a wrench, you may over-tighten the connections and damage your equipment. Such damage is *not* covered by the Limited Warranty.

7. Thread the RG-6 coaxial cable through the mast support arm and the Y-bracket. This cable should be long enough to run from your receiver to your LNBF.

Note: See *Running Coaxial Cables* on page 101 for cable installation guidance.

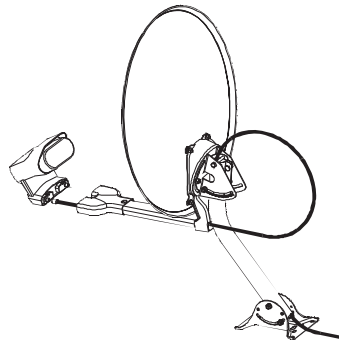

8. Attach the Y-bracket, using the Y-bracket screw.
9. Connect the RG-6 cable from the DISHPro **SAT IN** connection on the back of the receiver *directly to port 1* of the DISHPro Twin LNBF, as shown

Installation Instructions

below. Be sure there are no multi-dish switches between the LNBF and the receiver.

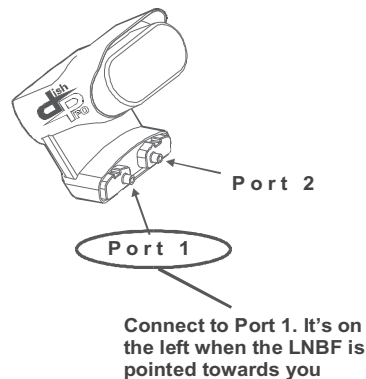

10. Attach the LNBF to the Y-bracket using the two LNBF screws.
11. Slide the dish assembly down onto the mast. Make sure the pivot bolt rests on the top of the mast. Turn the dish assembly so that it points in the general direction of the satellites, using the azimuth angle from 84.
12. You should see the **Point Dish/Signal** menu. If not, open the **Main Menu**, select **System Setup**, then **Installation**, then **Point Dish/Signal** (press MENU and then press 6-1-1 on the remote).

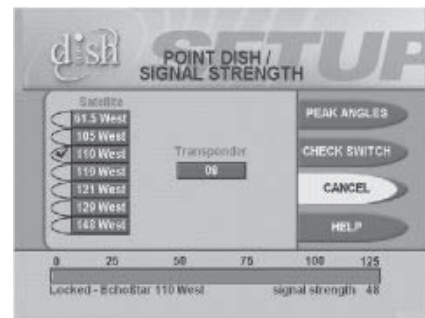
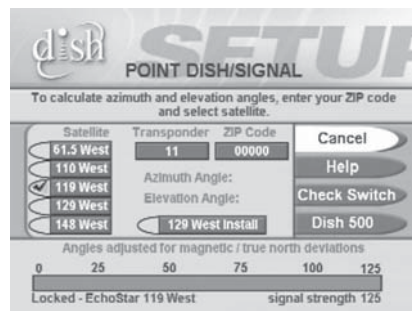

13. Select **Check Switch**. The **Check Switch** screen will open.
14. **Select Check** or **Test**. The receiver shows you a message that it is checking the switches. Go to step 15.
15. When the check switch procedure finishes, you will see an installation summary screen similar to the one below. In the **Satellite** line, you will see "Conn." In the **Device** line, you will "Twin" twice. This indicates that your receiver has confirmed the connection with your DishPro Twin LNBF is working. The Transponder line may show two "Xs." This is OK and does not indicate a problem with the receiver.

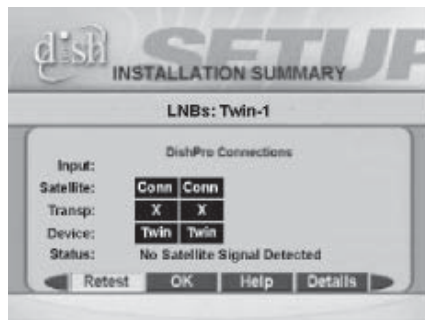

16. Select **Cancel** or **OK** to return to the **Point Dish/Signal** screen. Make sure the check mark is next to **119 West**. If not, move the highlight to **119 West** and press **SELECT**. Notice the signal strength bar. This is used to help you aim the dish by showing the strength of the signal you are receiving. Look at the signal strength bar while you aim the dish. Don't stand in front of the dish while you aim it, because your body will block the satellite signal. After you adjust the aim, let go of the dish so that you can get a good signal reading after the dish settles back in place by itself. **Do not change the skew setting.**
17. Turn the dish back and forth **very slowly**, until the signal strength bar turns **green**. This shows you've found the signal.

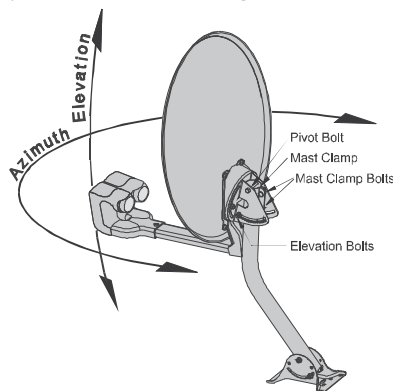

Note: If you cannot find the signal, turn the dish back to the first azimuth angle. Then, loosen both elevation bolts *just enough* so you can tilt the dish. Tilt the dish elevation up by two degrees, and then tighten both bolts. Now, turn the dish back and forth again. *If you still can't find the signal*, tilt the dish up again *very slightly* and turn the dish back and forth until you find the signal.

18. Once the signal strength bar is *green*, turn the dish back and forth **just a little**, to where the signal strength bar shows the strongest signal. When you find the strongest signal, tighten both mast clamp bolts. Then loosen both elevation bolts, *just enough* so you can tilt the dish. Tilt the dish up and down **just a little**, to where the signal strength bar shows the strongest signal. **Do not adjust the skew.** When you find the strongest signal, tighten all bolts in the dish assembly so the dish cannot be moved.

Tip: Have one person aim the dish while another watches the signal strength or listens to the signal tone.

Installation Instructions

19. You are now ready to verify reception from both satellites. Select the **Check Switch** option. When the **Check Switch** menu opens, select **Check** or **Test**. The receiver shows you a message that it is checking the switches. When the procedure is finished, you will see an **Installation Summary** screen. This screen may look different than the one shown below. However, you *must* see that you have *signals from both* the **110 West** and **119 West** Satellites, you see “All” twice in the **Transponder** line, and the message “Satellite reception verified. Press CANCEL or OK to exit this menu.”

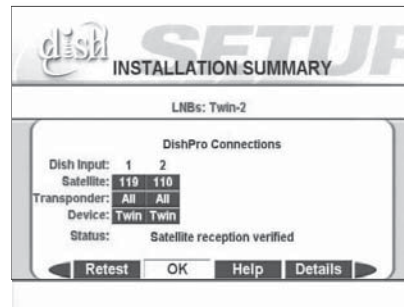

20. If you do not see “110” under **Dish Input 2**:
- Make sure the skew angle you wrote down on page 84 is exactly the same as the skew angle you set in step 5 on page 86. If it is not, reset the skew angle as described on page 86. After you reset the skew angle, go back page 89 and start over from step 16.
 - If “119” is shown under **Dish Input 2**, move the dish approximately 9° to the east and restart the procedure at step 12.
21. Look at the **Point Dish/Signal** menu. If you have good signal strength with the check mark in **119 West**, move the check mark to **110 West**. If you have good signal strength on **110 West**, go to step 22.
- If you do not have good signal strength with the check mark in **110 West**, go back to Step 17, and fine-tune the dish but with the check mark in **110 West** instead of **119 West**. While the 110 West and 119 West signals will not be equal, you should be able to fine-tune the dish until you have the strongest possible signal from both satellites.
22. Select Cancel to exit the **Point Dish/Signal** menu. An Attention screen will open asking the mounting and positioning of your dish is complete with a “Locked” indication in the Point Dish/Signals screen. If the answer is yes, select **Yes**.

*If the answer is **No**, you will need to repoint your dish following the preceding steps until the mounting and positioning is complete and you do have the “Locked” indication.*

23. After you select **Yes**, the receiver will begin taking a software upgrade. You will see a **Warning** that “Vital program information will now be downloaded into your receiver.” You will also see a status bar showing the progress of this upgrade.
24. Once the software upgrade is complete, you will see a message that your receiver’s memory is being upgraded.

Do not disturb the receiver while the receiver’s memory is being upgraded.

Note: If you are installing other DishPro receivers, be sure to run **Check Switch** on all of them, and allow them to take the necessary software upgrade.

If you will be installing a multi-dish system, follow the instructions that begin below.

Installing a Multiple Dish DishPro System

Note: You cannot use DishPro LNBFs and switches (those marked with the DishPro logo) with Legacy (non-DishPro) switches and LNBFs (those without the DishPro logo). You must install your DISH antenna system with either all DishPro LNBFs and switches or all Legacy LNBFs and switches. If you mix the two, the system will not work.

Note: You can have as much as 200 feet of cable between the DishPro LNBF and the DishPro receiver. However, you must use only RG-6 coaxial cables rated for 950 to 2150 MHz. Some cables may say "Swept tested for 2150 MHz." If you have any doubt about this, ask your DISH retailer, or look on the container the cable came in. Do not use cable company TV cables or cables from other satellite TV systems not rated for 950-2150 MHz. These other cables may cause signal loss. Do not use existing cables such as RG-59. Also, be sure that any outdoor connections are made using waterproof F-connectors.

Once you have installed the DISH 500 with its DishPro Twin LNBF using the preceding instructions, you can install a DISH 300 with a DishPro LNBF as follows:

1. Turn on the television and the receiver if they are not already on. You should see the **Point Dish/Signal** screen. If not, open the **Main Menu** and press 6-1-1 on the remote.

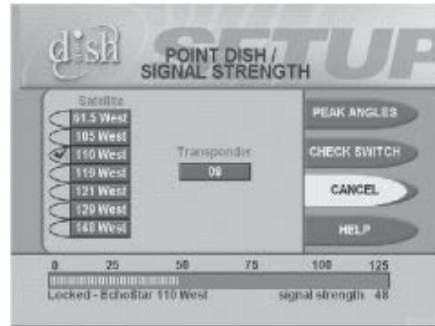
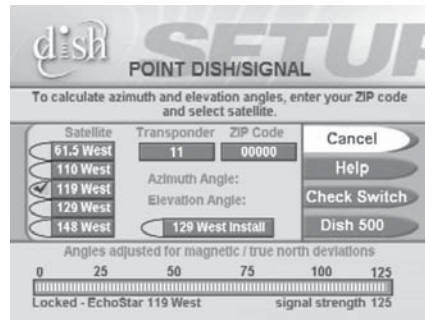

Azimuth: _____

Elevation: _____

2. Make sure the check mark is next to the satellite your dish will be pointed toward.
3. If your **Point Dish/Signal** screen looks like the one on the left, continue to step 4. If your **Point Dish/Signal** screen looks like the one on the right, select **Peak Angles** and the **Dish 300** option.
4. Select **Peak Angles**.
5. Use the number buttons on the remote to enter your ZIP code to get the necessary azimuth and elevation. Write these numbers down in the spaces provided in the margin.
6. Mount the dish antenna following the mounting instructions that came with it.
7. Connect an RG-6 cable from the DishPro **SAT IN** connection on the receiver directly to the DishPro LNBF on the Dish 300. Make sure there are no multi-dish switches between the LNBF and the DishPro receiver.
8. Select **Check Switch** from the **Point Dish/Signal** menu. When the **Check Switch** screen opens, select **Check**.
9. When **Check Switch** is complete, you will see an **Installation Summary** screen similar to the one shown next. It will show a connection (“Conn” next to satellite) and **Single** device under **1** (Dish Input). It may also show an **X** on the Transponder line. This is okay and does not mean there is a problem with the system.

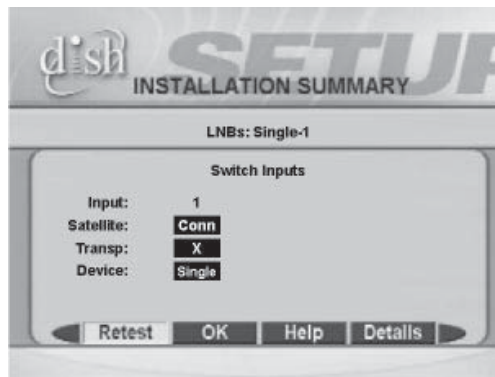

10. Press **CANCEL** to exit back to the **Point Dish/Signal** menu.
11. Point the dish for the strongest possible signal, following the instructions that came with it and the DishPro wiring diagrams that start on page 94.
12. Connect any switches in your system, using the instructions which came with the switch(es).
13. Select **Check Switch** from the **Point Dish/Signal** menu. When the **Check Switch** menu opens, select **Check** or **Test**. When the procedure completes, you will see the **Installation Summary** screen again. This time you should see confirmation for all satellites your dishes are pointed at, and “Satellite reception verified.” You should also see that the switch(es) in your system has been correctly identified.

Refer to the DishPro wiring diagrams for examples of installation summary screens.
14. Press **CANCEL** to exit this menu, and then **Cancel** to exit the **Point Dish/Signal** screen.

If you have any other receivers in your system, make sure you run **Check Switch** on each of them, and allow each to take the software upgrade, as needed.

DishPro Wiring Diagrams

DISH 500, One DishPro Twin LNBF, Two DishPro Receivers



This diagram leaves out grounding to be clear. Make sure you ground the system per the *National Electrical Code* (NEC) and all local electrical codes.

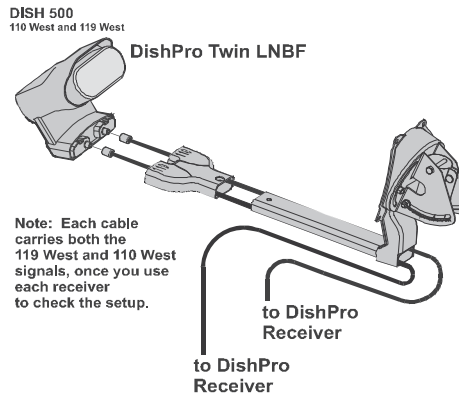

When you set up your system following this diagram and run **Check Switch** the **Installation Summary** screen should look similar to the one shown below.

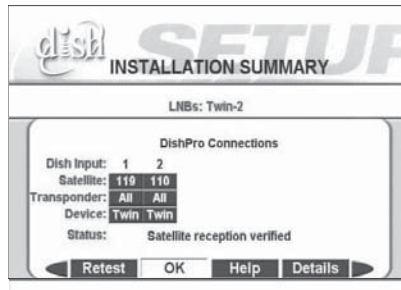

DISH 500, One DishPro Quad LNBF, Four DishPro Receivers



This diagram leaves out grounding to be clear. Make sure you ground the system per the *National Electrical Code* (NEC) and all local electrical codes.

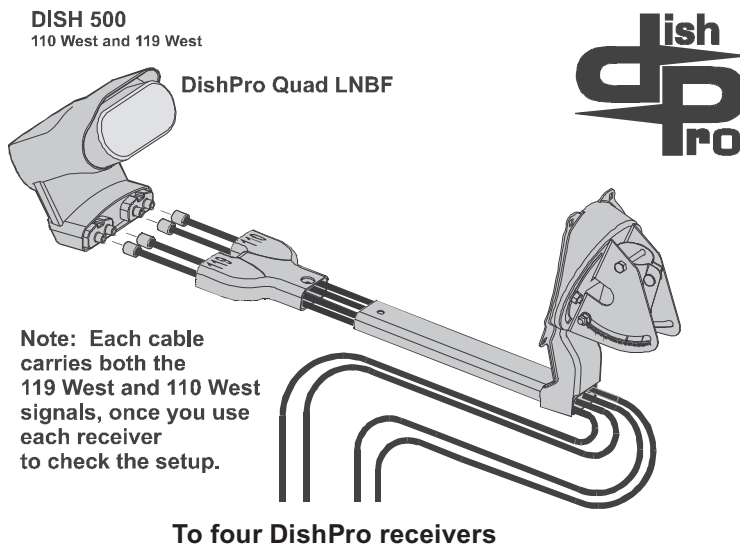

When you set up your system following this diagram and run **Check Switch** the **Installation Summary** screen should look similar to the one shown below.

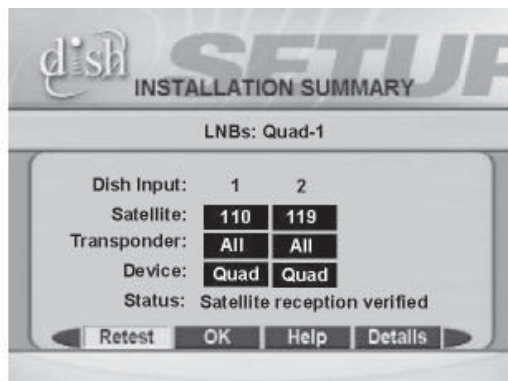

DISH 500 with a DishPro Twin LNB, One DISH 300 with a DishPro LNB, DP34 Switch, Four DishPro Receivers



This diagram leaves out grounding to be clear. Make sure you ground the system per the *National Electrical Code* (NEC) and all local electrical codes.

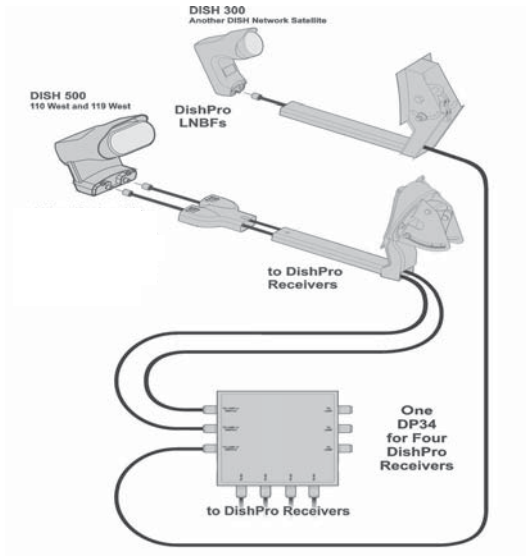

When you set up your system following this diagram and run **Check Switch** the **Installation Summary** screen should look similar to the one shown below.



Two Dishes, Three Single-Output DishPro LNBs, Three Cables, DP34 Switch, Four DishPro Receivers



This diagram leaves out grounding to be clear. Make sure you ground the system per the *National Electrical Code (NEC)* and all local electrical codes.

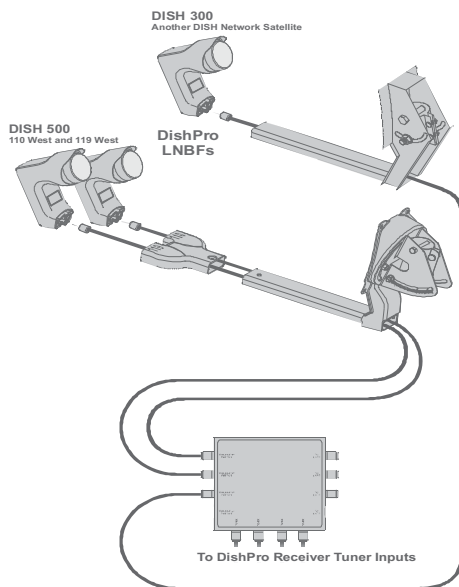

**One DP34
for four
DishPro
receivers**

When you set up your system following this diagram and run **Check Switch** the **Installation Summary** screen should look similar to the one shown below.

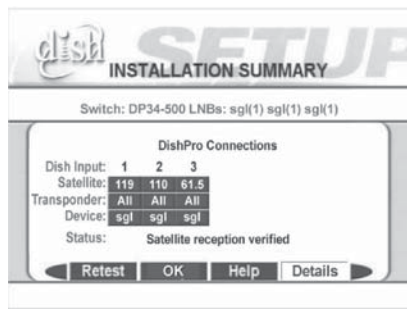

Two Dishes, One DishPro Twin LNBF, One DishPro Single LNBF, One DishPro Compliant Splitter, Two DishPro 2:1 Switches, Two Receivers



This diagram leaves out grounding to be clear. Make sure you ground the system per the *National Electrical Code* (NEC) and all local electrical codes.

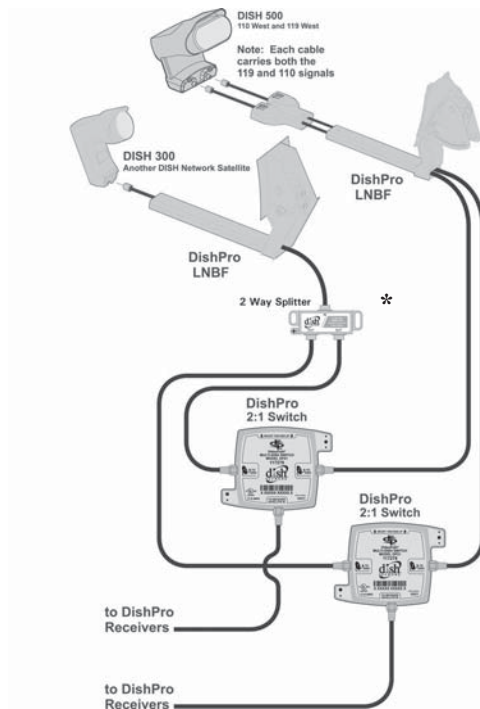

* When using a DishPro compliant splitter to split the signal from a DishPro single LNBF, the receiver whose DP21 switch is connected to the passing side of the splitter must be plugged into a live power outlet at all times. If not, the DishPro single LNBF will not have any power and will not be able to provide satellite signal to the other receiver.

When you set up your system following this diagram and run **Check Switch** the **Installation Summary** screen should look similar to the one shown below.



Two Dishes, Two DishPro Single LNBFs, Two DishPro Compliant Splitters, Two DishPro 21 Switches, Two Receivers



This diagram leaves out grounding to be clear. Make sure you ground the system per the *National Electrical Code* (NEC) and all local electrical codes.

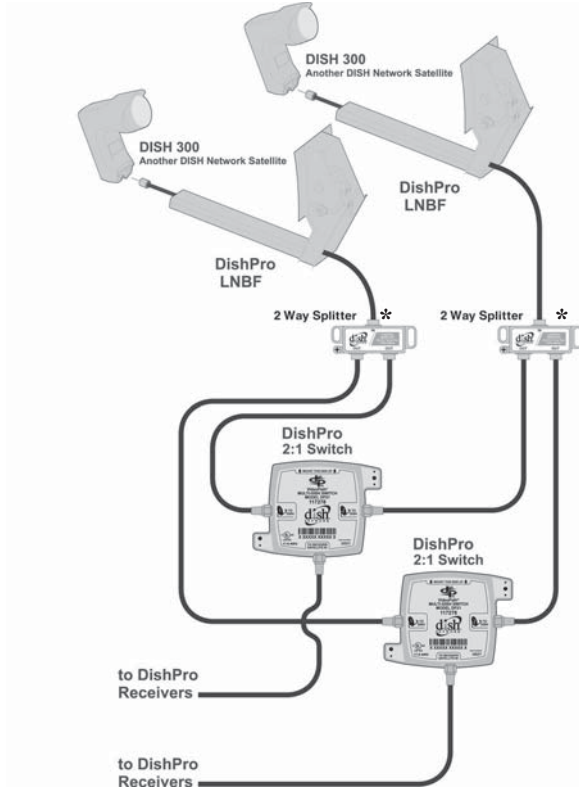

* When using a DishPro compliant splitter to split the signal from a DishPro single LNBF, the receiver whose DP21 switch is connected to the passing side of the splitter must be plugged into a live power outlet at all times. If not, the DishPro single LNBF will not have any power and will not be able to provide satellite signal to the other receiver.

When you set up your system following this diagram and run **Check Switch** the **Installation Summary** screen should look similar to the one shown below.

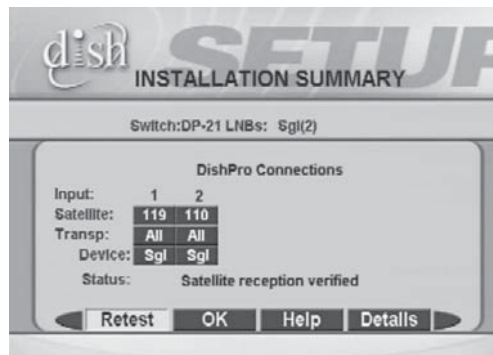

Installation Instructions

One DISH 500 with a DishPro Twin LNB, One DISH 300 with a DishPro Single LNB, and One DP21 Switch

This diagram leaves out grounding to be clear. Make sure you ground the system per the *National Electrical Code* (NEC) and all local electrical codes.

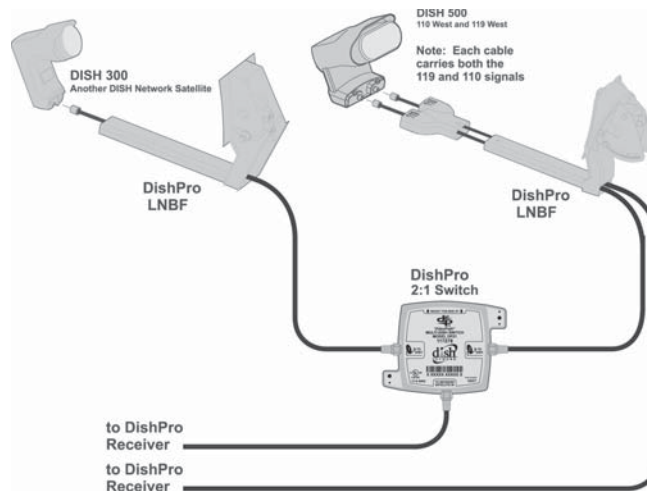

Note: This setup supports only one receiver from three satellite locations and the other receiver from only two satellite locations.

Running Coaxial Cable

- Using the shortest path possible, run the coaxial cable(s) from the ground block or switch to the satellite receiver(s). Do *not* kink or pinch any cable. Cables should be bent *only* in gentle curves.



Do *not* use a longer cable between the satellite dish and the receiver than is specified in the DishPro or Legacy system installation instructions. If your system requires more cable than the limit specified in these installation instructions, you should consider having the system professionally installed.

- Put a drip loop in each cable at a point before it enters the building. A drip loop allows moisture to drip from the cable before it runs into the building.

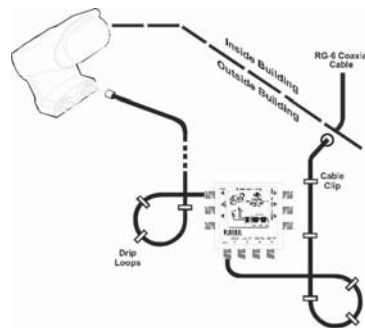

FOR EXAMPLE ONLY



Before drilling any holes in the wall or roof of your building, make sure that there are no wires or pipes in the area of the holes. If you are not comfortable doing this, contact a professional in your area. Make sure that you follow all safety instructions and building codes.

- Locate each receiver inside the building, against or near an outside wall. Then drill a hole through the outer wall to pass a cable inside the building. If a receiver is located in an interior room, run a cable through the outside wall, and into an attic, basement, or crawl space in order to reach the receiver.
- Seal all holes that you drill in the building with silicone or other weather-proof sealant after installation. Once each cable is inside the building, you may attach it to a wall receptacle or directly to a receiver.



Tighten the back panel coaxial cable connections *only* by hand. Using a wrench may over-tighten the connections, causing damage. Such damage is *not* covered by the Limited Warranty in the *User Guide* that came with the system.

Connecting Each Receiver to a Phone Line

You *must* keep each receiver connected to an active telephone line. Otherwise, you may not be able to order pay per view programs or use all of the Dish Interactive features. Run a telephone cable with a standard RJ-11 connector from each receiver's back panel **PHONE JACK** to an active telephone connection.

Note: You *may* be able to use a wireless telephone extender. However, this may *not* support all the features of some receivers, such as Caller ID.

Note: If you have a Digital Subscriber Line (DSL), you may have to install a DSL filter between the receiver's back panel **PHONE JACK** and the telephone wall jack to successfully connect with the DISH Network. You can obtain a filter from your DSL provider.

You *must* also set up each receiver for your telephone system (touchtone or rotary/pulse), and set a telephone number prefix, if you need a prefix to make an outside call.

1. Display the **Installation and Setup** menu (press MENU then 6-1-4).
2. Select the **Telephone System** option to display the **Telephone System Setup** menu.



3. Select the **Touch Tone** or the **Rotary/Pulse** option in the **Phone Type** list.

Note: Usually, you need a telephone number prefix only for business installations. For most residential installations, all you need to do is set the telephone system type. The default setting of **No Prefix needed** will allow correct dialing. If this is the case, select the **Save** option to save the above setting, and stop here. If you do need to set a prefix, then instead of selecting the **Save** option, go on to step 4.

4. Move the highlight to the **Outside Line Prefix** list. Press the **SELECT** button to select the highlighted option.

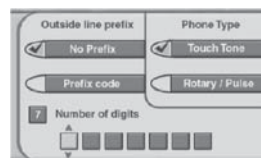

5. Select one of the following:
 - If you do not need to dial a prefix, select the **No Prefix** option.
 - If you need to dial a prefix (for example, dial 9 to get an outside line), select the **Prefix Code** option. The receiver displays the same number of boxes (highlighting the first box) where you must enter the digits. Use the Number Pad to enter the prefix code. As you enter each number, the highlight moves to the next box.
6. Move the highlight to the **Save** option. Press the **SELECT** button to save the settings.

Notes

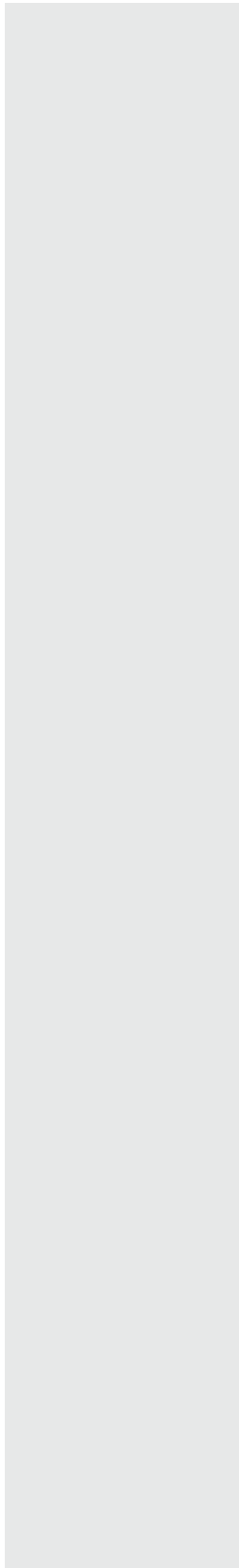

Chapter 5

Reference

USE THE TROUBLESHOOTING TABLES

You can often *save yourself time* if you troubleshoot the system *before* you call the Customer Service Center!

1. ***If the receiver displays an Error message on the TV screen***, see the *On-Screen Messages* table on page 112. Also, check the cables and make sure their connections are tight. ***If the receiver doesn't display an Error message***, go on to step 2.
2. ***Here's a simple fix for many problems: Press and hold*** the receiver's front panel POWER button for about five seconds, or until the POWER and RECORDING lights turn on, and then let go of the button. The TV screen will go blank for a few seconds, display a message that the receiver is acquiring the satellite signal, and then the picture will return.
3. Tune to the DISH Network info channels or see our www.dishnetwork.com Web site for tips.
4. Use the troubleshooting tables starting on the next page. In *any* troubleshooting table, here's what to do:
 - a.) Look under *What's Happening* until you find the problem.
 - b.) To understand the problem, look under *What's Wrong*.
 - c.) Try each of the tips under *What You Can Do*.
5. Review this *User Guide* for help.
6. For more help, call the Customer Service Center at 1-800-333-DISH (3474).

You can often save yourself time if you troubleshoot the system before you call the Customer Service Center!

Here's a simple fix for many problems!

Chapter 5

Reference

CHANNEL CHANGES

What's Happening	What's Wrong	What You Can Do
You enter a channel number you want. The channel changes, but the new channel isn't exactly the channel you entered.	<ul style="list-style-type: none"> Maybe you made a mistake when you entered the channel number, or maybe the channel number you entered doesn't work. If so, the receiver tunes to the channel closest to the channel you entered. If you entered the number for a channel you haven't bought, the receiver tunes to the channel and gives you the choice to buy it. 	<ul style="list-style-type: none"> Carefully enter the channel number you want again. Press the remote control RECALL button to go back to the previous channel number. To buy a channel, call the Customer Service Center at 1-800-333-DISH (3474).
You're scanning up or down through the channels, and the receiver skips channels you know you bought.	<ul style="list-style-type: none"> If you apply a Favorites List that's not All Chan, the receiver skips channels that aren't on the applied list. If you hide adult channels and lock the receiver, the receiver skips adult channels. 	<ul style="list-style-type: none"> Press GUIDE until All Chan is the active Favorites List. Unlock the receiver so it doesn't skip adult channels.
The receiver changes channels by itself.	<ul style="list-style-type: none"> Stray UHF signals from a nearby neighbor are interfering with your receiver. 	<ul style="list-style-type: none"> Install a 10 dB attenuator as described in <i>Attach an Attenuator</i>.

DISHDVR FEATURES

What's Happening	What's Wrong	What You Can Do
You find you can't watch part of a program you're auto recording.	<ul style="list-style-type: none"> If the receiver runs out of room to auto record a program, it starts to erase the oldest part of the program to make room for new audio and video. When you change the channel, you erase what's stored in auto recording. You <i>can't</i> watch part of a "live" program that hasn't been broadcast yet, because the receiver hasn't recorded it yet. 	<ul style="list-style-type: none"> To make sure you can watch all of a program, on-demand record it instead of auto recording it. If you want to be able to watch all of a program you're auto recording, don't change the channel. You can only auto record for about one hour.
You find the receiver didn't on-demand record a program.	<ul style="list-style-type: none"> Maybe you didn't press the remote control RECORD button while you watched the program or set an <i>Event Timer</i> to record it. Maybe the receiver ran out of room to on-demand record the program. You may have had a signal outage caused by bad weather during the recording. 	<ul style="list-style-type: none"> To on-demand record a program, you <i>must</i> either press the remote control RECORD button <i>or</i> set an <i>Event Timer</i>. If you set an <i>Event Timer</i> to record the program, maybe the <i>Event Timer</i> was not set up right. See the <i>Event Timers</i> table for help. Check the "time Left" on the DishDVR Recorded Events menu. If you "protect" many recorded programs, the receiver may not have enough room to record any new programs.
You find the receiver is missing programs you recorded.	If you don't "protect" a recorded program, and the receiver needs room to record a new program, it may record over that recorded program to have room.	Use the DishDVR Recorded Events menu to "protect" an on-demand recorded program. This means the receiver will ask you before it records over that recorded program. But note, if you "protect" many recorded programs, the receiver may not have enough room to record any new programs.
When you open a recorded program's info menu, some of the options seem to be missing.	You see menu options <i>only</i> when they work. <i>For example</i> , the Start option doesn't show up unless you select a recorded program.	You can use <i>only</i> the options you see on the menu. You won't see all the options at once. You'll never see a "Record" option; to record a program you <i>must either</i> press the remote control RECORD button or set an <i>Event Timer</i> .
On-demand recording stores only one program, or only part of one program.	On-demand recording works by program unless you set a manual event timer to start and stop the recording at the times you set yourself.	To record more than one program, or to record parts of one or more programs, set a manual event timer.

DOLBY DIGITAL SOUND

What's Happening	What's Wrong	What You Can Do
Instead of Dolby® Digital sound, you hear only regular stereo or non-stereo sound.	<ul style="list-style-type: none"> • Maybe the program you're watching doesn't have Dolby Digital sound. • Maybe you selected the wrong sound option on the Dolby Digital Setup menu. • Maybe the amplifier/decoder can't process Dolby Digital sound. • Maybe you didn't connect the receiver to an amplifier/decoder. 	<ul style="list-style-type: none"> • Not all programs have Dolby Digital sound. Check the program's Program Guide entry for the (DD) mark. • On the Dolby Digital Setup menu, select the Dolby Digital Only option if the amplifier/decoder can process <i>only</i> Dolby Digital signals, the PCM Only option if the amplifier can't process Dolby Digital, and the Dolby Digital/PCM option <i>only</i> if the amplifier can process <i>both</i> regular and Dolby Digital sound. Note: If you select the Dolby Digital/PCM option and the amplifier/decoder can't process Dolby Digital, you could damage the speakers. • If the amplifier/decoder can't process Dolby Digital, it won't provide Dolby Digital sound. See the amplifier user's manual or call your audio electronics dealer for more info. • Make sure you connect an amplifier/decoder that can process Dolby Digital sound to the receiver's back panel DOLBY DIGITAL output.

EVENT TIMERS

What's Happening	What's Wrong	What You Can Do
You want to use Quick Record, but the receiver displays the Create an Event Timer menu.	You highlighted a future program in the Browse Banner , in the Program Guide , or in a Themes list, and then pressed the SELECT button.	To use <i>Quick Record</i> , highlight a future program but <i>don't</i> press the SELECT button. <i>Instead</i> , press the RECORD button. Note: You can use the Create an Event Timer menu if you want, because it's almost as fast as <i>Quick Record</i> .
You try to set an event timer and the receiver displays a message that the program is locked.	You <i>must</i> enter the password <i>before</i> you can set an event timer for a locked program.	First enter the password, then you can set an event timer for the program.
You try to set an event timer and the receiver displays a message that the program is a pay per view event.	You <i>must</i> order a pay per view event <i>before</i> you can set an event timer for it.	First order the event, then you can set an event timer for it.
You try to set an event timer, but the receiver displays an Error message that gives you the choice to delete an event timer you set earlier.	You've already set as many event timers as you can.	Delete one of the event timers you set earlier, and then you can set a new event timer.
You set an event timer, but the receiver doesn't tune to the channel of the program, or doesn't record the program.	Maybe you set a <i>Reminder Event Timer</i> but you should have set a <i>DVR Event Timer</i> , an <i>Auto-Tune Event Timer</i> , or a <i>VCR Event Timer</i> .	Remember, a <i>Reminder Event Timer</i> just reminds you the program is about to start. An <i>Auto-Tune Event Timer</i> reminds you and tunes the receiver to the channel of the program. A <i>VCR Event Timer</i> reminds you, tunes the receiver, and starts the VCR to record. A <i>DVR Event Timer</i> reminds you, tunes the receiver, and starts the receiver to record with the DishDVR features. Note: The receiver <i>won't</i> turn the VCR on, so you <i>must</i> leave it turned on. Note: A <i>DVR Event Timer</i> can work <i>only</i> if the receiver has enough room to record. See the <i>DishDVR Features</i> table for help.

EVENT TIMERS

What's Happening	What's Wrong	What You Can Do
You set an event timer for a program that comes on each day or each week, but the timer is either recording the wrong program or sometimes misses programs.	<ul style="list-style-type: none"> • Maybe you set the timer with the wrong frequency. • Maybe the network changed the program time. 	Remember, a <i>Once</i> event timer works just one time for one program, at the program's actual time. A <i>Mon-Fri</i> event timer works Monday through Friday on the same channel at the same time, not keyed to any program. A <i>Daily</i> event timer does the same, Monday through Sunday. A <i>Weekly</i> event timer works once a week on the same channel at the same time, not keyed to any program.
You set an event timer, but the timer doesn't work at all.	Maybe the program time changed so the event timer overlapped another event timer.	If the receiver is on and finds an event timer overlap, it displays the Event Timer Scheduling Conflict menu. You <i>must</i> edit or delete one of the overlapping event timers.
You set a <i>Once</i> event timer, but the timer doesn't work at the time you expect.	The program time changed.	A <i>Once</i> event timer always works at the program's actual time.
You stop an event timer for one showing of a program that comes on each day or each week, but the timer works for the next showing.	When you stop a repeated event timer, this applies <i>only</i> to the timer's action right then.	To stop all actions of a repeated event timer, you <i>must</i> delete the event timer. Note: The receiver deletes a <i>Once</i> event timer right after it works.
You test a VCR code to see if the receiver controls a VCR. The VCR doesn't do the test.	<ul style="list-style-type: none"> • Maybe you didn't turn on the VCR, maybe you didn't put a tape in, maybe you didn't rewind the tape, or maybe you took the write-protect tab off the tape. • Maybe the code you're testing doesn't work for the VCR. 	<ul style="list-style-type: none"> • Make sure you turn on the VCR and put a rewind tape in. Make sure the write-protect tab is on the tape so that recording is permitted. • Try another VCR code from the table.

EVENT TIMERS

What's Happening	What's Wrong	What You Can Do
<p>You set a <i>VCR Event Timer</i>, but the VCR doesn't record the program you want.</p>	<ul style="list-style-type: none"> • Maybe you didn't turn on the VCR, or put a rewind tape in, or maybe you took the write-protect tab off the tape. • If you use the receiver back panel TV Set Out ports in the wiring setup, maybe you didn't set the receiver channel 3/4 setting and both the VCR modulator output and viewing channel to either 3 or 4. • Maybe something blocks the signal path between the receiver and the VCR. • If you set the <i>VCR Event Timer</i> with the Create an Event Timer menu, maybe you selected an <i>Auto-Tune</i>, <i>Reminder</i>, or <i>DishDVR</i> timer instead of a <i>VCR</i> timer. • If you did select a <i>VCR</i> timer, maybe you selected the wrong timer frequency. • If you set the <i>VCR Event Timer</i> with <i>Quick Record</i>, the timer was one-time only, and missed another showing of the program. 	<ul style="list-style-type: none"> • Make sure you turn on the VCR and put a rewind tape in. Make sure the write-protect tab is on the tape. • If you use the TV Set Out connections, you <i>must</i> set the receiver channel 3/4 setting and <i>both</i> the VCR modulator output <i>and</i> viewing channel to either 3 or 4. • Remove anything that blocks the signal path between the receiver and the VCR. • When you set a <i>VCR Event Timer</i>, make sure to select the <i>VCR</i> option in the Timer Type list on the Create an Event Timer menu. Also, make sure to select the right option in the Timer Frequency list on this menu. • Remember, with <i>Quick Record</i> you can set <i>only a Once</i> (one-time only) timer.
<p>You edit an <i>automatic</i> event timer. The timer doesn't start or doesn't end with a program's start and stop times.</p>	<p>When you edit an <i>automatic</i> event timer, you <i>change</i> it to a <i>manual</i> event timer. A manual timer starts and stops at the times you set, <i>not</i> the start and stop times of any program.</p>	<p>If you want an <i>automatic</i> event timer to start and stop with a program's start and stop times, don't edit the event timer.</p>
<p>You try to set a <i>manual</i> event timer. The receiver displays an Error message.</p>	<p>Maybe you tried to set a <i>manual</i> event timer for a pay per view program or with start or stop times that don't work.</p>	<p>Remember, you <i>can't</i> set a <i>manual</i> event timer for a pay per view program. Also, you <i>must</i> set the end time <i>after</i> the start time, <i>and</i> at least one minute later than the start time.</p>
<p>The receiver doesn't display the program name for a <i>manual</i> event timer.</p>	<p>Maybe the receiver can't display a program name for a <i>manual</i> event timer.</p>	<p>Use the Program Guide or a printed list to find the program name.</p>
<p>You set an event timer. The event timer misses the beginning or the end of a program.</p>	<p>Maybe the program started a little earlier than it was supposed to, or maybe it ran over the time it was supposed to end.</p>	<ul style="list-style-type: none"> • Use the Start 1 min. early option to start <i>any</i> event timer (<i>except</i> for a pay per view event) one minute early. • Use a <i>manual</i> event timer to start <i>any</i> event timer (<i>except</i> for a pay per view event) at the times <i>you</i> set.

Chapter 5

Reference

FAVORITE LISTS

What's Happening	What's Wrong	What You Can Do
You press the remote GUIDE button while you've got the Program Guide open. You find you can apply <i>only</i> the All Chan list or the All Sub list.	If you don't add channels to any custom Favorite List, you can apply <i>only</i> the All Chan list or the All Sub list.	You <i>must</i> add channels to a custom Favorite List <i>before</i> you can apply it.
You try to change the All Chan list or the All Sub list. The receiver displays an Error message.	You <i>can't</i> change the All Chan list or the All Sub list.	Choose another list to change. Note: You <i>can</i> change the All Sub list by buying channels. To buy a channel, call the Customer Service Center at 1-800-333-DISH (3474).
You try to apply an empty Favorite List. The receiver displays an Error message.	You <i>can't</i> apply an empty list.	Choose another list to apply, or add at least one channel to the empty list.
A Favorite List doesn't show channels you know you added to it.	If you hide adult channels and lock the receiver, no Favorite List shows adult channels.	Unlock the receiver for the list to show adult channels.

LOCKS

What's Happening	What's Wrong	What You Can Do
You set a lock (<i>for example</i> , a lock on programs by ratings), but the lock doesn't work.	Maybe you didn't lock the receiver.	You <i>must</i> lock the receiver to apply any lock you set (<i>that is</i> , to make it work).
You forgot the password, so you can't unlock the receiver.	Maybe you didn't write down the password and keep it in a safe place.	Call the Customer Service Center at 1-800-333-DISH (3474). You <i>must</i> give us your name, your address, your telephone number, the receiver serial number (open the Important System Information menu to get it), and your PIN, if you use one.

MENUS

What's Happening	What's Wrong	What You Can Do
You're using a menu, and it suddenly closes.	The receiver "times out," and closes any menu after several minutes with no action. This throws away any changes you make, but the receiver is still okay.	Start over again.
A menu option is "grayed out," and you can't select it.	The option is for a feature that may come with a future software upgrade.	Ignore the option.
In the Program Guide , a channel has a red background.	<ul style="list-style-type: none"> • Maybe you haven't bought the channel. You <i>must</i> buy a channel <i>before</i> you can tune the receiver to it. • Maybe you've exceeded your event limit. • Maybe there's a problem with the channel's broadcast. 	<ul style="list-style-type: none"> • To buy a channel, call the Customer Service Center at 1-800-333-DISH (3474). • Review your pay per view purchases to check your event limit. If you've exceeded the limit, call the Customer Service Center. • Try to tune to the channel later.
The Program Guide doesn't show a picture in the upper right-hand corner.	<ul style="list-style-type: none"> • Maybe you haven't set up the <i>Program Guide</i> to show the last channel you watched in the upper right-hand corner. • Maybe you just opened the <i>Program Guide</i>, or just changed the channel. 	<ul style="list-style-type: none"> • Set up the <i>Program Guide</i> to show the last channel you watched in the upper right-hand corner. • When you first open the <i>Program Guide</i> or when you change the channel, there may be a <i>brief</i> delay before a picture shows up.
You try to display future programs in the Program Guide or Browse Banner , but find you can't.	The Program Guide and Browse Banner can display programs that'll come on for some time into the future, but not forever.	Check the Program Guide again later. By then, it may show programs for the time and date you want.
You try to display programs that have ended in the Program Guide or Browse Banner , but find you can't.	The Program Guide and Browse Banner can display <i>only</i> programs that haven't yet ended. These features <i>can't</i> display a time before now.	Call the program providers for details on past programs.
When you use the Program Guide or Browse Banner , some channels seem to be missing.	<ul style="list-style-type: none"> • Maybe you applied a Favorite List that's not the All Chan list. • Maybe you hid adult channels and locked the receiver. • If your setup includes a multi-dish switch, maybe you need to do the Check Switch procedure. 	<ul style="list-style-type: none"> • You can change the applied Favorite List while you use the Program Guide - just press the remote control Guide button. You can choose another custom Favorite List, the All Chan list (it includes all the channels), or the All Sub list (it includes all the channels you've bought). • Unlock the receiver to let the Program Guide show adult channels. • Do the Check Switch procedure (see the installation instructions for what to do).

ON-SCREEN MESSAGES

Note: Here we list on-screen messages in *message number* order. Just find the message number in the upper right-hand corner of the message, and then find the same number on the Left-hand side of this table.

Message Number	What's Wrong	What You Can Do
001	Maybe there's a problem with the multi-dish switch.	<ul style="list-style-type: none"> • Check the cables and their connections to and from the multi-dish switch. • Make sure all the cables are in place, and their connections are tight. • If this doesn't work, call the Customer Service Center for help.
002	<ul style="list-style-type: none"> • Heavy rain, snow, or cloud cover can interfere with the satellite signal. • Maybe there's other interference. 	<ul style="list-style-type: none"> • Check the local weather. Brush any snow, leaves, <i>etc.</i> off the satellite dish. • Make sure the satellite dish has a clear line of sight to the satellite. • Check whether branches or leaves have grown into the line of sight. • Make sure you aim the satellite dish at the satellite. Check the strength of the signal with the Point Dish/Signal menu. • If this doesn't work, call the Customer Service Center for help.
003, 004	<ul style="list-style-type: none"> • Maybe your system uses the wrong kind of cable, or maybe the cable run is too long. • Maybe there's a problem with the multi-dish switch. 	<ul style="list-style-type: none"> • Make sure your system uses RG6 cable. • See <i>Chapter 4, Installation Instructions</i> for the proper cable length for your system. • Check the cables and their connections to the multi-dish switch. Make sure all the cables are in place, and their connections are tight. • If this doesn't work, do the Check Switch test. See the installation instructions for what to do. • If this doesn't work, call the Customer Service Center for help.
005	Maybe we haven't yet linked the receiver with the Smart Card, via the satellite signal.	<ul style="list-style-type: none"> • If you've called the Customer Service Center to order your program packages, wait a few minutes to see if the message goes away. If it doesn't go away, call the Customer Service center. • Try resetting the receiver using the front panel POWER button. • If you <i>haven't</i> called the Customer Service Center to order your program packages, do so.
006, 007, 008	<ul style="list-style-type: none"> • Maybe you haven't connected the receiver to an active telephone line. • Maybe you've gone over the Smart Card credit limit. • Maybe the receiver is connected to a DSL (digital Subscriber Line) phone line. 	<ul style="list-style-type: none"> • You <i>must</i> connect the receiver to a phone line at <i>all</i> times. If you install two or more receivers, do this for <i>each</i> receiver. • Review what you've bought with pay per view to check the Smart Card credit limit. If you've gone over the limit, call the Customer Service Center. • If this doesn't work, call the Customer Service Center for help. • Install a DSL filter between the receiver and the telephone wall jack.
011, 012	In some areas you <i>can't</i> watch some programs. <i>For example</i> , if you live close to a football stadium you can't watch football games played there.	<ul style="list-style-type: none"> • Remember, the program providers decide which programs they "black out," <i>not</i> DISH Network.
013, 014	Maybe you tried to tune to a program on a channel you haven't bought.	<p>You <i>must</i> buy a channel <i>before</i> you can tune to a program on that channel. Call the Customer Service Center (at 1-800-333-DISH [3474]) to buy a channel, or if you think the receiver displayed this message by mistake.</p> <p>Wait until bad weather conditions have cleared so that your receiver can get the authorization from the satellite.</p>

Message Number	What's Wrong	What You Can Do
015	<ul style="list-style-type: none"> Maybe you just plugged in the receiver, and it's acquiring the satellite signal. Maybe the receiver briefly lost the signal. 	<ul style="list-style-type: none"> Wait a few minutes to see if the message goes away. Make sure all the cables are in place, and their connections are tight. Make sure the satellite dish has a clear line of sight to the satellite. Check whether branches or leaves have grown into the line of sight. Make sure the Signal Strength bar in the Point Dish/Signal menu is green and displays the word Locked.
018	<ul style="list-style-type: none"> Maybe you haven't connected the receiver to a phone line. Maybe you've gone over the Smart Card credit limit. 	<ul style="list-style-type: none"> You <i>must</i> connect the receiver to a phone line at all times. If you install two or more receivers, do this for <i>each</i> receiver. Review what you've bought with pay per view to check the Smart Card credit limit. If you've gone over the limit, call the Customer Service Center. Call the Customer Service Center (at 1-800-333-DISH [3474]) to have us set you up to buy a pay per view program.
019	Maybe you put the Smart Card in up side down or backwards.	<ul style="list-style-type: none"> Make sure you put the Smart Card in right side up, with the picture on top and the arrow facing into the receiver's front panel slot. If this doesn't work, call the Customer Service Center for help.
020	The receiver works <i>only</i> with the Smart Card that we linked to it via the satellite signal.	<ul style="list-style-type: none"> Put the right Smart Card into the receiver's front panel slot. Call the Customer Service Center for help.
021	Maybe the Smart Card is missing or you didn't put it in the right way.	Make sure you put the Smart Card all the way into the receiver's front panel slot.
022	<ul style="list-style-type: none"> Maybe we haven't yet linked the receiver with the Smart Card, via the satellite signal. Maybe the satellite dish has moved so it's not getting the satellite signal. Maybe the cable connections are loose. Maybe the satellite signal has been interrupted. 	<ul style="list-style-type: none"> If you've called the Customer Service Center to order your program packages, wait a few minutes to see if the message goes away. If it doesn't go away, call the Customer Service center. If you <i>haven't</i> called the Customer Service Center to order your program packages, do so. Make sure all the cables are in place, and their connections are tight. Make sure the satellite dish has a clear line of sight to the satellite. Check whether branches or leaves have grown into the line of sight. Make sure the Signal Strength bar in the Point Dish/Signal menu is green and displays the word Locked.
025, 026	Maybe the receiver briefly lost the satellite signal. <i>For example</i> , around the start of spring and again around the start of autumn, the sun is right behind the satellite. When this happens, sunlight overpowers the satellite signal for just a few minutes. This happens to all satellite television providers. Once the sun isn't behind the satellite, the receiver will get the signal again.	<ul style="list-style-type: none"> Wait a few minutes to see if the message goes away. Make sure all the cables are in place, and their connections are tight. Make sure the satellite dish has a clear line of sight to the satellite. Check whether branches or leaves have grown into the line of sight. Make sure the Signal Strength bar in the Point Dish/Signal menu is green and displays the word Locked.
028	Maybe the receiver needs to get new software before you can use it to order pay per view programs.	Turn the receiver off. Doing this lets the receiver get new software via the satellite signal. This may take several minutes; <i>don't</i> disturb or unplug the receiver while it gets the upgrade. When the upgrade is done, you'll be able to use the receiver to order pay per view programs.
032	Maybe you tried to set a <i>VCR Event Timer</i> but didn't set up the receiver to control the VCR.	You <i>must</i> set up the receiver to control the VCR <i>before</i> you can set a <i>VCR Event Timer</i> . See <i>Control a VCR</i> in <i>Chapter 2 - How to Use the System</i> for what to do.
059	Maybe you tried to close an installation menu without doing the Check Switch test.	If your setup includes a multi-dish switch, you <i>must</i> do the Check Switch test.
060	Maybe you aimed the satellite dish at one satellite, but selected another satellite's option on the Point Dish/Signal menu.	<ul style="list-style-type: none"> Make sure you select the option for the right satellite on the Point Dish/Signal menu. Make sure you connect the cable(s) for the satellite you select to the LNBF that gets signals from that satellite. Re-aim the satellite dish at the right satellite.

Message Number	What's Wrong	What You Can Do
061	You set up the receiver to get an upgrade of the latest software via the satellite signal.	It's <i>very</i> important for the receiver to get the latest software, so let it. This may take several minutes. <i>Don't</i> disturb or unplug the receiver while it gets the upgrade.
074	The receiver gives you three chances to enter the right password. If you can't, the receiver "times out" and won't allow you to try again for several minutes.	Wait a few minutes and then try again to enter the password. Note: The "time out" feature keeps someone from trying password after password until he or she happens to guess the right one and gets into the receiver.
078, 079, 080	<ul style="list-style-type: none"> • Maybe you haven't connected the receiver to a phone line. • Maybe the phone line doesn't work. • Maybe the receiver is connected to a DSL (Digital Subscriber Line) phone line. 	<ul style="list-style-type: none"> • Connect the receiver to a phone line. • Make sure the receiver's phone line works right. Note: To order pay per view programs, you <i>must</i> keep the receiver connected to a phone line at <i>all</i> times. If your setup includes more than one receiver, do this for <i>each</i> receiver. The receiver uses the phone line to make toll-free calls, usually in the middle of the night, to send info to the Customer Service Center. Install a DSL filter between the receiver and the telephone wall jack.
083	<ul style="list-style-type: none"> • You have a DSL (Digital Subscriber Line) telephone line which is interfering with the modem. • The phone line is not connected. • A phone jack splitter, caller ID device, or some other device is between the receiver and the phone jack. 	<ul style="list-style-type: none"> • Install a DSL filter between the receiver and the telephone wall jack. • Make sure the phone line is connected. • Make sure there are no phone jack splitters, caller ID devices, or other devices between the receiver and the phone jack.
093, 094	Maybe you reset the receiver to the "factory defaults," which means the settings it had when we shipped it from the factory.	If you want to reset the receiver to its factory default settings, select the Yes option. If you don't, select the No option.
303	You set up the receiver to get an upgrade of the latest software via the satellite signal.	It's <i>very</i> important for the receiver to get the latest software, so let it. While it does, it's green front panel light will blink. <i>Don't</i> disturb or unplug the receiver while it gets the upgrade.
336	A problem with the DVR data on the receiver's hard drive has been detected.	Select OK. The receiver will re-initialize (reformat) the disk. You will lose all your recorded events, but you will then be able to use all the DVR and recording features again.
343	This message is displayed when trying to access DISH Home from the Main Menu when there is no signal from 110. Troubleshoot for signal loss on 110.	A Dish 500 upgrade is required for access to features, call 1-800-333-DISH.
355	Your satellite receiver has exceeded the recommended operating temperature. Placing items on top of the receiver or housing your receiver in an enclosed cabinet with limited airflow may cause this problem. Continued operation at this temperature will damage the receiver!	This error message is for receivers with hard drives only. If the receiver has good airflow, it will need to be replaced. If the receiver is in an enclosure, it will need to be moved so it can receive adequate airflow to cool it. <ol style="list-style-type: none"> 1. Verify the receiver is in an open area to receive good airflow for cooling. 2. If the receiver is in an enclosed space, the receiver must be moved to prevent damage from overheating. 3. If the receiver is in an open space, the receiver should be replaced using fail code Hard Drive Failure.

PAY PER VIEW

What's Happening	What's Wrong	What You Can Do
Someone orders a pay per view program without asking you.	Maybe you were away from the receiver, and someone else used it.	Lock pay per view. <i>Remember, you have to pay for all programs you or anyone else buys with the receiver.</i> If you lock pay per view, anyone who wants to order a pay per view program <i>must</i> enter the password.
You find you can't order a pay per view program.	<ul style="list-style-type: none"> • Maybe you haven't connected the receiver to a phone line. • Maybe you've gone over your event limit. 	<ul style="list-style-type: none"> • You <i>must</i> connect the receiver to a phone line at <i>all</i> times. If you install two or more receivers, do this for <i>each</i> receiver. • Review what you've bought with pay per view to check the event limit. If you've gone over the limit, call the Customer Service Center.
You find you can't cancel a pay per view program.	You ordered a pay per view program, and then decided not to watch it.	You <i>can't</i> cancel an order for a pay per view program, whether you just ordered it or ordered it earlier.
Your setup includes more than one receiver. You order a pay per view program, but it doesn't show up on all of the receivers.	You ordered a pay per view program, and want it to get it on all the receivers in your setup.	You can watch a pay per view program on TVs you connect to up to six receivers. To do this, you must <i>order</i> the program for <i>each</i> receiver but you <i>pay</i> for the program <i>only once</i> .

PHONE

What's Happening	What's Wrong	What You Can Do
You have connected a phone line to the receiver but when it tries to dial out, it fails.	Maybe you have a Digital Subscriber Phone Line (DSL).	Install a DSL filter between the receiver and the telephone wall jack. Make sure no other device in the phone line is blocking the signal between the receiver and the phone jack.
While you're making a phone call, you hear "clicks."	Maybe the receiver tried to call the Customer Service Center to send pay per view purchase info. When the receiver found the phone was busy, it hung up.	You don't have to do anything. You can <i>always</i> use your phone line, because the receiver hangs up if the line is busy.
You pick up the phone to make a call, but you don't hear a dial tone.	Maybe the receiver was calling the Customer Service Center to send pay per view info. When the receiver found the phone was busy, it hung up.	Hang up, and then pick up the phone again to get a dial tone.
Your computer or FAX machine tries to send a FAX or modem transmission, but fails.	Maybe the receiver was calling the Customer Service Center to send pay per view info. When the receiver found the phone was busy, it hung up. The FAX or modem found there was no dial tone, and stopped the transmission.	Send the FAX or modem transmission again.
Your computer or FAX machine was receiving a FAX or modem transmission, but there was an error.	Maybe the receiver tried to call the Customer Service Center to send pay per view purchase info in the middle of a FAX or mode call. When the receiver found the phone was busy, it hung up. This made "clicks" that caused the error.	Have the sender send the FAX or modem transmission again.

PICTURE

What's Happening	What's Wrong	What You Can Do
<p>The receiver's front panel POWER light is on, but the TV image:</p> <ul style="list-style-type: none"> • is black (no picture), • is frozen, • has break-ups, • has "snow," or • shows small squares of many colors. 	<ul style="list-style-type: none"> • Maybe the TV set isn't working right. • If the TV and the receiver are working right, maybe there's interference with the satellite signal. • Maybe you wired the TV to the wrong port. 	<ul style="list-style-type: none"> • Make sure you plug the TV into an outlet. Make sure the outlet has power. • Make sure you turn on the TV. • If you connect the receiver to the TV with <i>only</i> the TV Set Out connections, make sure you tune the TV channel 3 or 4 (whichever works best in your area) and set the receiver's back panel channel 3/4 switch to the same channel as the TV. • Make sure you adjust the TV brightness and contrast. • Make sure you connect the TV to the receiver the right way and that the TV is set up to display the right input where the satellite receiver is connected. • Make sure you turn off the TV's text mode and closed captioned features. • Make sure you install the system the right way. Make sure all the cables are in place, and their connections are tight. • Make sure the satellite dish has a clear line of sight to the satellite. • Check whether branches or leaves have grown into the line of sight. • Make sure you aim the satellite dish at the satellite. • Check the strength of the signal with the Point Dish and Signal Strength menu. • Check the local weather. Heavy rain, snow, or cloud cover can interfere with the satellite signal. Brush snow, leaves, <i>etc.</i> off the satellite dish.
<p>The receiver's front panel POWER light is on, and there's a picture on the TV screen, but the picture:</p> <ul style="list-style-type: none"> • has sparkles or is grainy, • has a herringbone pattern, • lacks color or vertical hold, or wobbles, or • looks "washed out" or fuzzy. 	<ul style="list-style-type: none"> • Maybe the TV set isn't working right. • If you connect the receiver to the TV with only the TV ANTENNA/ CABLE IN and TV SET OUT ports, maybe there's a strong local broadcast on the same channel, or on a channel next to the one where you tuned the TV. • Maybe there's interference from other nearby devices (like cell phones, computers, microwave ovens, radios, stereos, or TVs). 	<ul style="list-style-type: none"> • Make sure you adjust the TV brightness and contrast, and the TV is working right. • Make sure you connect the TV to the receiver the right way. • Check whether nearby devices are sources of interference. • Make sure all the cables are in place, and their connections are tight. • Check the dish-to-receiver cable run length; if it's over 100 feet, call the Customer Service Center for help. • Change the receiver CH3/CH4 switch and the TV both to the other channel (3 or 4) to eliminate the interference.
<p>A "black box" fills almost all of the TV screen.</p>	<p>Maybe you turned on the Closed Captioned feature on the TV, and put that feature into Text mode.</p>	<p>Use the TV remote control and/or menus the TV displays (<i>not</i> the receiver remote control or menus the receiver displays) to turn off the closed captioned feature.</p>
<p>The TV screen is all blue.</p>	<p>Maybe you connected the receiver to an input on the TV that's wrong for the signal output from the receiver. Maybe a VCR is causing the problem.</p>	<ul style="list-style-type: none"> • Check your TV user's manual for the right TV input to use for the signal from the receiver. • Set up your TV to display the right input where your receiver is connected. • Make sure the receiver is on. • If a VCR is installed between the receiver and TV, turn the VCR off to loop the receiver signal to the TV.

REMOTE CONTROL

What's Happening	What's Wrong	What You Can Do
While you do a remote procedure, the remote control "times out."	<ul style="list-style-type: none"> • If you don't press any button for 20 seconds, the remote "times out." • If you hold a button longer than two minutes, the remote control stops transmitting. 	<ul style="list-style-type: none"> • Start over again. • Designed to save battery life.
You can't find the remote control.	<ul style="list-style-type: none"> • N/A 	<ul style="list-style-type: none"> • Use the receiver's front panel buttons to control the receiver until you find the remote. • If the remote control is lost for good or too damaged to use, call the Customer Service Center to order a replacement.
When you press the remote control POWER button to turn the receiver on, the receiver's front panel POWER light doesn't turn on.	<ul style="list-style-type: none"> • Maybe the remote control batteries are weak or dead. • Maybe you didn't plug the receiver power cord into a power outlet, or maybe there's a problem with the power. • Maybe the remote isn't in SAT mode. • Maybe the remote and the receiver have different addresses. 	<ul style="list-style-type: none"> • Try other remote control buttons to see if the receiver responds. Replace the remote batteries with fresh ones. • Make sure the receiver power cord is okay, and put the plug into the outlet the right way. • Make sure you set the remote to SAT mode to control the receiver. • Make sure the remote and the receiver have the same address. See <i>Change the Address</i> on page 21.
When you press a button on the remote control, the device doesn't do what you expect.	<ul style="list-style-type: none"> • Maybe you're trying to control a device and you're not pointing the remote control right at it. • Maybe the remote control is missing batteries, maybe you put the batteries in the remote the wrong way, or maybe the batteries are weak or dead. • Maybe you didn't set the remote to the mode for the device you want to control. • Maybe you didn't set up the remote to control the device. • Maybe UHF signals from a neighbor's remote are blocking signals from your remote. 	<ul style="list-style-type: none"> • Remember, the remote control uses IR signals to control all devices except for the receiver. IR signals travel <i>only</i> 40 feet or less, and <i>can't</i> go through walls or other solid objects. You <i>must</i> point the remote control right at the device, with <i>no</i> objects to block the signal path. • If the batteries are missing or dead, put fresh AAA-size batteries in. If the remote has fresh batteries, check whether you put them in the right way. If you didn't, take them out and put them in the right way. • Make sure you set the remote to the mode for the device you want to control, by pressing the correct mode button. • Make sure you set up the remote to control all the devices you want to use. • Put a UHF attenuator on the receiver's UHF REMOTE ANTENNA input. This will help keep stray signals from blocking your remote's signals, but also cut down how far away you can use the remote. • Change the remote control and receiver address. See <i>Change the Address</i> on page 21.
When you press the remote control MUTE or VOLUME button, nothing happens.	<ul style="list-style-type: none"> • Maybe you did not set up the remote to control a TV. • Maybe you're trying to control TV volume but you set up the remote to control a tuner or amplifier in AUX mode. • Maybe you're trying to control tuner or amplifier volume but you set up the remote to control a TV in AUX mode. 	Set up the remote to control <i>either</i> TV volume <i>or</i> tuner/amplifier volume, whichever you want.

Chapter 5

Reference

SOUND

What's Happening	What's Wrong	What You Can Do
The receiver's front panel POWER light is on and there's a good picture on the TV set, but you don't hear any sound.	<ul style="list-style-type: none">• Maybe you muted the sound, or set the volume so low you can't hear it.• Maybe you didn't connect the audio cables the right way.	<ul style="list-style-type: none">• Check the volume level on the TV or audio device. Turn off the mute or turn up the volume.• Check the audio connectors and cables from the receiver to the TV or the sound system.• Check the TV speakers or the sound system.
You hear a foreign language with a program.	Maybe you set the receiver to select a foreign language.	See <i>Change Program Languages</i> in <i>Chapter 2 - How to Use the System</i> to select the language you want.

TEST THE SYSTEM

START ANY TEST

1. Press the MENU button.
2. Select the **System Setup** option.
3. Select the **Diagnostics** option.
Note: “Diagnostics” are just “tests.”
4. Select the option for the test you want to do.
Note: If we upgrade the receiver software, we may add new tests.



TEST THE PHONE CONNECTION

1. Make sure you connect a phone line to the receiver's back panel PHONE JACK.
2. Select the **Connection** option. The receiver displays a message that asks you to wait until the test is done.
 - If the phone connection is okay, the receiver displays a message that says so.
 - If the receiver displays a message that it needs to make a toll-free call to the Customer Service Center, select the **Dial Out** option. The receiver displays a message that asks you to wait until it finishes the call. When the receiver finishes the call, select the **Cancel** option.
 - If you didn't connect the phone line right, the receiver displays a message that says so. Check the phone connection and then do the test again.

CONNECTION

DIAL OUT

CANCEL

Note: If you have a Digital Subscriber Line (DSL), you may need to install a DSL filter between the receiver and the telephone wall jack, and then do the test again.

DEVICE CODES

These tables contain the manufacturer codes for programming the remote to control your TV, a VCR, DVD player, cable box, or audio amplifier. Every attempt has been made to include all codes. If your device brand is not listed or if the codes do not work, the remote may not control your device. In some cases codes may operate some but not all buttons shown in this guide.

TV CODES

TELEVISION	CODES
Admiral	514, 521
Akai	532, 570, 573
Alba	613
A-Mark	620
Amstrad	533
Anam	509, 541, 620, 621, 691, 698
AOC	505, 506, 519, 520, 620, 695, 712
Archer	620
Audiovox	620
Bauer	611
Baycraft	536
Brockwood	695
Broksonic	562, 691
Candle	506, 522, 523, 525, 536, 691, 695, 712
Capehart	519, 695
Circuit City	695
Citizen	506, 516, 522, 523, 524, 525, 526, 691, 712
Colortyme	573, 695
Concerto	523
Contec	527, 528, 541, 591, 691
Craig	536, 541, 691, 694
Crown	526, 536
Curtis Mathes	506, 516, 526, 573, 703, 712, 708
CXC	541, 691
Daewoo	505, 524, 526, 529, 530, 531, 532, 698, 712, 719
Daytron	526, 695

TELEVISION	CODES
Dixi	532, 588, 620
Dumont	695
EchoStar	722
Electrohome	526, 573, 709, 713
Elta	532
Emerson	526, 527, 528, 533, 534, 535, 536, 537, 538, 539, 540, 541, 573, 622, 691, 692, 695, 696, 699, 720,
Envision	506, 712
Etron	532
Fisher	542, 590
Formenti	611
Fortress	573, 605
Fujitsu	534, 694
Funai	534, 541, 691, 694
Futuretech	541, 691, 694
General Electric (GE)	503, 508, 509, 515, 540, 543, 544, 630, 695, 698, 701, 714, 715, 716
Genexxa	613
Goldstar	505, 523, 526, 545, 546, 573, 588, 693, 712
Granada	695, 711
Grand	695
Grandiente	711
Grundig	547
Hallmark	695
Harmon Kardon	561
Hinari	534
Hitachi	523, 526, 548, 549, 550, 551, 552, 553, 554, 555, 585, 597, 626, 702, 718
Infinity	566

TELEVISION	CODES
JBL	566
JC Penney	503, 505, 506, 516, 526, 531, 543, 596, 701, 714
Jenson	556, 573
JVC	557, 558, 559, 560
Kawasho	548, 561, 712
Kenwood	506, 573, 712
Kloss	522, 561, 610, 698
KTV	526, 539, 540, 541, 691, 696, 712
Lloyds	695
Lloytron	526
Loewe	588
Logik	518
Luxman	523
LXI	503, 563, 566, 590, 595, 617, 625, 701
Magnasonic	573
Magnavox	506, 520, 525, 536, 564, 565, 566, 567, 568, 569, 573, 575, 610, 710, 712
Marantz	506, 566, 573, 588, 712
Matsui	532, 609
Megatron	695
Memorex	518, 532, 590, 695, 720
MGA	504, 505, 506, 571, 573, 695
Mitsubishi	504, 505, 570, 571, 572, 597, 623, 695, 705, 707, 712
MTC	505, 506, 516, 523, 531, 695, 712
NAD	502, 617, 695
National	509, 697, 698
National Quenties	697

TELEVISION	CODES
NEC	505, 506, 507, 517, 523, 573, 627, 712
Nikkai	612, 613, 618
Nordmende	551
Normandic	717
Novabeam	561, 698
Nyon	701
Onwa	541, 691
Optonica	605, 607
Orion	694
Osaki	612
Panasonic	508, 509, 510, 511, 512, 566, 574, 685, 686, 687, 689, 697, 698, 700, 706, 714, 716
Philco	505, 506, 525, 536, 564, 565, 568, 573, 610, 712
Philips	566, 588
Pioneer	502, 548, 551, 576, 708
Portland	505, 526, 712
Proscan	503
Proton	513, 519, 526, 536, 585, 624, 695
Pulsar	501
Quasar	508, 509, 577, 698, 700
Radio Shack	526, 541, 607, 612, 691, 698
RCA	503, 505, 515, 548, 579, 580, 581, 582, 583, 584, 586, 587, 625, 633, 634, 691, 698, 701, 708, 714, 715, 716
Realistic	590
Saba	551
Saisho	532, 533, 609
Sampo	506, 519, 698
Samsung	505, 506, 516, 523, 526, 532, 588, 612, 695, 704, 712, 721
Samwon	620
Sanyo	542, 589, 590, 591, 592, 609

TELEVISION	CODES
SBR	588
Schneider	588
Scott	526, 534, 537, 541, 593, 600, 691, 696, 701
Sears	503, 523, 534, 542, 563, 589, 590, 594, 595, 596, 598, 599, 601, 602, 603, 604, 617, 695, 703
Seimitsu	695
Sharp	526, 585, 591, 605, 606, 607, 608, 628, 629
Siemens	591
Signature	518
Silver	573
Solavox	612
Sony	500, 578, 609, 619, 622, 690
Soundesign	525, 536, 541, 691, 695
Spectricon	520, 620
Squareview	694
SSS	505, 541, 573, 691, 712
Supra	523
Supre-Macy	522
Sylvania	506, 525, 536, 564, 565, 566, 568, 573, 575, 600, 610, 611, 712
Symphonic	632, 692, 694
Tandy	605, 613
Tatung	509, 698
Technics	508
Techwood	523, 573
Teknika	504, 505, 516, 518, 522, 523, 524, 525, 526, 534, 536, 541, 614, 615, 686, 691, 712
Teleavia	551
Telefunken	551
Teletch	532
Tera	513
Thomas	695

TELEVISION	CODES
Thompson	709
Thomson	551, 616
TMK	523, 573, 695
Toshiba	516, 590, 596, 617, 618, 631, 688
Tosonic	528
Totevision	526
Toyomenko	695
Universal	543
Vector Research	506
Victor	557
Video Concepts	570, 691
Vidtech	505, 695, 712
Viking	522
Wards	505, 506, 515, 518, 534, 536, 543, 564, 565, 567, 568, 607, 619, 712, 714, 715
Yamaha	505, 506, 712
York	695
Zenith	501, 518, 693
Zonda	620

VCR CODES

VCR	CODES
Aiwa	588, 622, 623, 624
Akai	513, 514, 515, 516, 517, 518, 519, 520, 568,
Alba	546
Amstrad	588
ASA	565
Audio Dynamics	594, 600
Broksonic	559
Bush	589
Candle	580, 592, 593
Canon	542, 553, 554
Capehart	543, 546
Citizen	591, 592, 593
Craig	591, 608

Chapter 5

Reference

VCR	CODES
Croslex	553
Curtis Mathes	554, 592, 605
Daewoo	534, 545, 546, 547, 593
Daytron	546
DBX	594, 600
Dumont	549
Dynatech	588
Electrohome	609
Emerson	505, 506, 507, 508, 509, 510, 511, 512, 559, 568, 588, 590, 609, 618
Finlandia	549
Finlux	549, 565, 588
Fisher	548, 549, 584, 588, 608, 610
General Electric (GE)	550, 551, 552, 554, 572, 591, 605
Goldstar	530, 555, 592, 612, 613
Goodmans	585, 589
Go Video	557, 558, 620
Granada	549, 581
Grundig	565
Harmon Kardon	530, 569
Hinari	589
Hitachi	536, 537, 538, 539, 540, 541, 553, 588, 595, 596, 597
Instant Replay	553
ITT	518
JC Penney	530, 554, 580, 591, 594, 600, 601
Jenson	560
JVC	561, 562, 563, 564, 592, 594, 600, 601
Kenwood	562, 581, 592, 594, 600, 601
Lloyd	588
Logik	589
Luxor	518

VCR	CODES
Magnavox	527, 553, 554, 556, 565, 611
Marantz	530, 554, 565, 585, 592, 594, 600, 601, 603
MEI	554
Memorex	533, 549, 554, 566, 581, 585, 588, 608
MGA	567, 568, 609
Mitsubishi	562, 567, 568, 569, 570, 571, 609
MTC	544, 580, 588
Multitech	588, 589, 591
NAD	573
NEC	530, 531, 532, 562, 592, 594, 599, 600, 601, 602, 603, 604
Olympic	553
Optonica	585
Orion	506, 507
Panasonic	521, 522, 523, 524, 526, 553, 554, 598, 614, 628, 633
Pentax	537, 592
Perdio	588
Philco	553, 554, 611
Philips	553, 554, 565, 585
Pioneer	553, 562, 573, 574, 575, 576, 600
Portland	546, 593
Proscan	553, 605
Pulsar	533
Quartz	581
Quasar	553, 554, 577, 578
Radio Shack	607, 608, 609, 610
RCA	525, 526, 527, 528, 529, 537, 553, 591, 605, 606, 615, 630, 631
Realistic	549, 554, 580, 581, 584, 585, 588
Ricoh	502
Saisho	506, 507
Salora	567, 581

VCR	CODES
Samsung	517, 534, 579, 580, 591
Sansui	532, 544, 562, 600, 621
Sanyo	549, 581, 582, 583, 608
SBR	565
Schneider	589
Scott	508, 559, 590
Sears	548, 549, 581, 584, 608, 610,
Sentra	546
Sharp	585, 607, 609, 625
Shintom	589
Sony	500, 501, 502, 503, 504
Sylvania	553, 554, 556, 567, 588, 611
Symphonic	588, 594
Tandy	588
Tashiko	588
Tatung	586, 594, 601
Teac	588, 594, 601
Technics	553, 554
Teknika	554, 587, 588
TMK	506
Toshiba	534, 535, 567, 590
Totevision	580, 591
Unitech	580
Vector Reaserch	530, 600
Victor	561, 562, 600
Video Concepts	568, 600
Videosonic	591
Wards	527, 554, 580, 585, 588, 589, 590, 591, 607, 608, 609
Yamaha	530, 592, 594, 600, 601
Zenith	500, 501, 533

DVD PLAYER CODES

DVD Players	Codes
Aiwa	634
Hitachi	632, 635
JVC	636
Konka	637, 638
Magnavox	626
Mitsubishi	629
Panasonic	639
Philips	640, 641, 642
Pioneer	619
RCA	627
Sanyo	643
Sony	617, 644, 645
Toshiba	616, 646, 647
Zenith	648

TUNER/AMPLIFIER CODES

Tuner/Amplifier	Codes
Aiwa	656, 680, 687, 718, 719, 720, 723, 724, 725, 726
Carver	653, 706
Citizen	709
Denon	674
Fisher	653, 706
GE	665, 711
Goldstar	677, 690
Harmon Kardon	672
Hitachi	717
JVC	657, 683, 703, 727
Kenwood	676, 691, 728
Luxman	681, 686
LXI	665
Magnavox	705
Marantz	708
Memorex	675, 692
NAD	669, 696

Tuner/Amplifier	Codes
Nakamichi	671, 694
NEC	716
Onkyo	660, 662, 678, 689, 699, 700
Optimus	664, 697
Panasonic	652, 707
Pioneer	658, 661, 667, 668, 675, 679, 688, 692, 702
Proton	654, 705
Quasar	652, 707
RCA	655, 704, 729
Realistic	665, 666
Scott	659, 701
Sharp	712, 713, 714, 715
Sherwood	670, 695
Sony	673, 680, 687, 693, 730, 731
Symphonic	666
Teac	684
Technics	652, 658, 707
Toshiba	710
Victor	657, 703
Yamaha	663, 682, 685, 698, 732, 733

CABLE BOXES

Cable Boxes	Codes
Eastern	649
CI/Tocom	640
Jerrold	635, 636
Memorex	637
Oak	646
Panasonic	637, 644, 645
Paragon	637
Pioneer	642, 643
Regency	649
Scientific America	638, 639, 647, 648, 650
Zenith	641

Notes

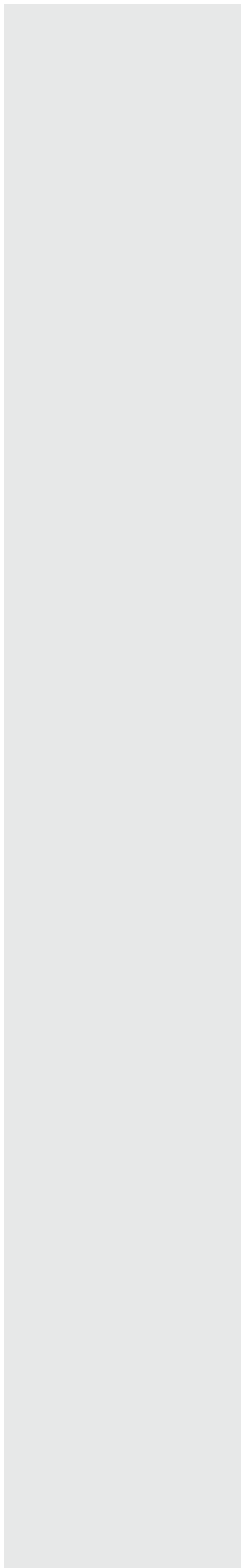

Appendix A

Installing a DishPro Receiver into an Existing System

These instructions guide you through the installation of your new DishPro satellite receiver in an existing system where your satellite dish(es) has already been installed and pointed for the strongest possible signal. If your DishPro dish antenna(s) is not already installed, you will need to follow the *Installation Instructions* found in *Chapter 4*.

There are two dish antenna systems that are covered by these installation instructions.

- DishPro antenna systems which have the DishPro logo shown below.



- Legacy antenna systems which *do not* have the DishPro logo.

Installation Instructions

1. Connect an RG-6 coaxial cable (see notes below) from the **SAT IN** port on the receiver's back panel to an available port on your switch or LNBF in your existing system. See *Chapter 4* wiring diagrams for appropriate receiver connections in your system. See *Running Coaxial Cabling*.

Note: If you are installing a DishPro receiver into a system with DishPro LNBFs (and/or switches), you can have as much as 200 feet of cable between the LNBF and the receiver. However, you must use only RG-6 coaxial cables rated for 950 to 2150 MHz. Some cables may say "Swept tested for 2150 MHz." If you have any doubt about this, ask your Dish retailer, or look on the container the cable came in. Do not use cable company TV cables or cables from other satellite TV systems not rated for 950-2150 MHz. These other cables may cause signal loss. Do not use existing cables such as RG-59. Also, be sure that any outdoor connections are made using waterproof F-connectors.

Note: If you are installing the DishPro receiver into a system with Legacy LNBFs and/or switches (that do not have a DishPro logo), you can have as much as 100 feet of cable between the LNBF and the receiver. However, you must use only RG-6 cable - do not use existing cables such as RG-59. Also, be sure that any outdoor connections are made using waterproof F-connectors.

Warning: Tighten all the coaxial cable connections only by hand. Using a wrench may over-tighten the connections, causing damage. Such damage is not covered by the Limited warranty.

2. Connect a coaxial cable from the **TV SET OUT** connection on your receiver to your television's RF tuner input. Check to see that the Channel 3/4 switch on the new receiver's back panel is set to the same channel (3 or 4) as your TV.
3. Plug in the receiver's power cord. Make sure both the receiver and TV are turned on.
4. You should see the **Point Dish/Signal** menu in the new receiver. If you do not, open the **Main Menu**, by pressing **Menu** followed by **6-1-1** on the remote.
5. Select **Check Switch** or **Test**. An Attention screen will open. Select **Check** to run Check Switch.
6. When Check Switch is complete, you will see an **Installation Summary** screen. If the screen shows the correct switch and the message "Satellite reception verified" for all satellites in your system, go to step 7. If the **Installation Summary** screen does not detect all of the satellites your system should be receiving, check and retighten (by hand) the cable connections between your receiver, LNBFs and switches in your system. Then press **Retest** or **Test** to rerun **Check Switch** again.
7. Select **OK** or **Cancel** to return to the **Point Dish/Signal** screen. Then select **Cancel** to exit the **Point Dish/Signal** screen.
8. An **Attention** screen will open. This screen asks if the mounting and positioning of your dish is complete with a "Locked" indication in the **Point Dish/Signal** screen. Since your system is already installed and your dish is pointed for the strongest possible signal strength, you can select **Yes**.
9. The receiver will begin taking a software upgrade. You will see the message shown below.

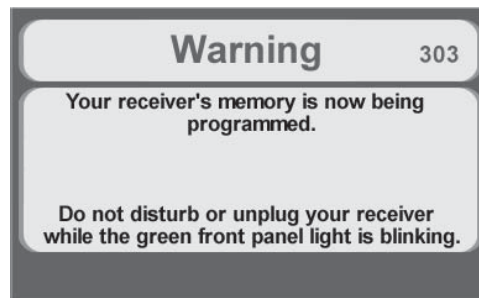

A progress bar at the bottom of the screen will show how the software upgrade is progressing. Once the software upgrade is complete, you will see a second message that the receiver's memory is now being programmed.

This message may disappear; your screen may go blank for a few minutes, and the green light may continue to blink. This is normal and does not indicate a problem with the receiver.

10. When the software upgrade is complete, press **View** and you should now be able to watch TV programming. To activate your programming on this newly installed receiver, call 1-800-333-DISH (3474). See *Chapter 1, Introduction*.

Appendix B

Limited Warranty



This **Limited Warranty** is a legal document. Keep it in a safe place. Remember to retain your Bill of Sale for warranty service! Any items returned without a copy of the Proof of Purchase will be considered out of warranty.

What the Warranty Covers

This warranty extends *only* to the original user of the equipment and is limited to the purchase price of each part. EchoStar Communications Corporation and its affiliated companies (“EchoStar”) warrant this system against defects in materials or workmanship as follows:

- **LABOR:** For a period of one (1) year from the original date of purchase, if EchoStar determines that the equipment is defective subject to the limitations of this warranty, it will be replaced at no charge for labor. EchoStar warrants any such work done against defects in materials or workmanship for the remaining portion of the original warranty period.
- **Parts:** For a period of one (1) year from the original date of purchase, EchoStar will supply, at no charge, new or re-manufactured parts in exchange for parts determined to be defective subject to the limitations of this warranty. EchoStar warrants any such replacement parts against defects in materials or workmanship for the remaining part of the original warranty period. **Note:** “Parts” means items included in this package, which may include the satellite dish assembly, receiver, LNBF, remote control, or dish mounting hardware. It does *not* include other parts purchased separately.

What the Warranty Does Not Cover

- This warranty *does not cover* replacement of lost or damaged Smart Cards.
- This warranty *does not cover* installation of the system. If applicable, such installation will be warranted under a separate installation agreement.
- This warranty *does not cover* consumer instruction, physical setup or adjustment of any consumer electronic devices, remote control batteries, signal reception problems, loss of use of the system, or unused programming charges due to system malfunction.
- This warranty *does not cover* cosmetic damage, damage due to lightning, electrical or telephone line surges, fire, flood, or other acts of Nature, accident, misuse, abuse, repair or alteration by other than authorized factory service, use of accessories not recommended by the receiver manufacturer, negligence, commercial or institutional use, or improper or neglected maintenance.
- This warranty *does not cover* equipment sold AS IS or WITH ALL FAULTS, **shipping and handling**, removal or reinstallation, shipping damage if the equipment was not packed and shipped in the manner prescribed, nor equipment purchased, serviced, or operated outside the continental United States of America.

Legal Limitations

REPLACEMENT AS PROVIDED UNDER THIS WARRANTY IS YOUR EXCLUSIVE REMEDY. ECHOSTAR SHALL NOT BE HELD LIABLE FOR ANY INCIDENTAL OR CONSEQUENTIAL DAMAGES FOR BREACH OF ANY EXPRESSED OR IMPLIED WARRANTY ON THIS SYSTEM, NOR FOR ANY INCIDENTAL OR CONSEQUENTIAL DAMAGES RESULTING FROM THE USE OF, OR INABILITY TO USE, THIS SYSTEM. UNDER NO CIRCUMSTANCES SHALL ECHOSTAR'S LIABILITY, IF ANY, EXCEED THE PURCHASE PRICE PAID FOR THIS SYSTEM. EXCEPT TO THE EXTENT PROHIBITED BY APPLICABLE LAW, ANY IMPLIED WARRANTY OF MERCHANTABILITY OR FITNESS FOR A PARTICULAR PURPOSE ON THIS SYSTEM IS LIMITED IN DURATION TO THE PERIOD OF THIS WARRANTY. ECHOSTAR RESERVES THE RIGHT TO REFUSE TO HONOR THIS WARRANTY IF ECHOSTAR DETERMINES ANY OF THE ABOVE EXCEPTIONS TO HAVE CAUSED THIS SYSTEM NOT TO HAVE PERFORMED PROPERLY. THIS WARRANTY SHALL BE VOID IF ANY FACTORY-APPLIED IDENTIFICATION MARK, INCLUDING BUT NOT LIMITED TO SERIAL OR CONDITIONAL ACCESS NUMBERS, HAS BEEN ALTERED OR REMOVED. THIS WARRANTY SHALL ALSO BE VOID IF THE RECEIVER HAS BEEN OPENED BY AN UNAUTHORIZED PERSON.

If You Need Assistance

1. Call the Customer Service Center at 1-800-333-3474. Have the date of purchase and either your customer account number, the receiver conditional access number, or the receiver model number ready. Display the **Important System Information** menu to find these numbers.
2. A Customer Service Representative will assist you.
3. If the Representative determines you should return any equipment, you will be directed to call a Return Authorization representative. *Before shipping* any equipment, you *must* talk to a Return Authorization representative and *must* obtain a Return Authorization (RA) number.
4. You will be given the appropriate address for which to return your equipment. Whether under warranty or not, you will be responsible for the cost of shipping back the defective equipment. For faster service, see the *Advance Exchange Program* below.
5. Returned equipment must be packaged properly, using either the original shipping materials or the packaging in which the replacement equipment is shipped. Include a copy of the Bill of Sale. *Any items returned without a copy of the Proof of Purchase will be considered out of warranty.* Follow the instructions given to you by the Customer Service Representative.
6. Write the RA number in large, clearly visible characters on the outside of the shipping box that you use to return the equipment. *To avoid confusion and misunderstandings, shipments without an RA number clearly visible on the outside of the box will be returned to you at your expense.*
7. If you return the receiver, you *must* return the Smart Card with the receiver. If you do not return the Smart Card with the receiver, a fee will be assessed against your account.

Advance Exchange Program

The Advance Exchange Program allows you to have replacement equipment shipped immediately to you (depending upon where you live, it could take three to five business days). Along with replacement equipment, you will receive a prepaid shipping label and instructions on how to return the defective equipment.

The shipping charge, for receiving replacement equipment and returning the defective equipment, is a one-time fee based on EchoStar's competitive bulk shipping rates (additional charges may apply outside of the continental US). This fee will be charged to your billing account or your valid credit card.

If you do not ship the defective equipment to EchoStar within ten days after receiving the replacement, your billing account or credit card will be charged the market price of the replacement. If you return the defective equipment *after* ten days, you will receive a full refund less an administrative fee.

If your equipment is out of warranty and can be repaired your billing account or credit card will be charged the standard repair fee for the replacement. If damage to the defective equipment is found, which EchoStar in its sole discretion determines has voided the warranty, or makes the equipment unrepairable, billing account or credit card will be charged the market price of the replacement.

Post Receipt Exchange Program

You may choose to ship the equipment to us at your cost. To provide faster service, upon receipt of your equipment you will be shipped a replacement. Your original equipment will not be available for return.

The equipment you return will be checked to verify whether it is covered under this warranty. If the defective equipment is covered under this warranty, it will be replaced and shipped back to you at no additional cost (additional charges may apply outside of the continental US).

If your equipment is out of warranty and can be repaired your billing account or credit card will be charged the standard repair fee for the replacement. If damage to the defective equipment is found, which EchoStar in its sole discretion determines has voided the warranty, or makes the equipment unrepairable, your billing account or credit card will be charged the market price of the replacement.

Accessory Warranty

An accessory is any DISH Network branded equipment, displaying the DISH Network logo, excluding the receiver, Smart Card, cables and hookups, and non-mechanical components. A one-year warranty becomes effective upon the activation of the DISH system or date of purchase, if bought separately. A proof of purchase is required to verify the purchase date. If an accessory has an expired warranty, no exchange will be issued. You may purchase replacement accessories from DISH Network or your local retailer.

Residential Customer Agreement

Effective as of September 1, 2001 until replaced.

THIS DOCUMENT DESCRIBES THE TERMS AND CONDITIONS UNDER WHICH DISH NETWORK WILL PROVIDE ITS SERVICE TO YOU. IF YOU DO NOT ACCEPT THESE TERMS AND CONDITIONS, PLEASE NOTIFY US IMMEDIATELY AND WE WILL CANCEL YOUR SERVICE. IF YOU ARE A NEW DISH NETWORK CUSTOMER, YOUR ACTIVATION OF A DISH NETWORK ACCOUNT AND RECEIPT OF DISH NETWORK SERVICES SHALL CONSTITUTE YOUR ACCEPTANCE OF THIS AGREEMENT AND ITS TERMS AND CONDITIONS WILL BE LEGALLY BINDING UPON YOU.

IF YOU ARE AN EXISTING DISH NETWORK CUSTOMER, YOUR CONTINUED RECEIPT OF DISH NETWORK SERVICES FOLLOWING RECEIPT OR PUBLICATION BY DISH NETWORK ON ITS WEB SITE OF THIS AGREEMENT SHALL CONSTITUTE YOUR ACCEPTANCE OF ITS TERMS AND CONDITIONS, AND, ACCORDINGLY, THEY WILL BE LEGALLY BINDING ON YOU.

Thank you for choosing DISH Network for your television service provider. DISH Network is happy to answer any questions you may have and to provide you with technical and other customer support through the following toll-free number and email address:

1-800-333-DISH

feedback@echostar.com

or you may write to:

**DISH Network
Customer Service Center
P.O. Box 33577
Northglenn, CO 80233**

and, for general knowledge, try our website at **www.dishnetwork.com**.

“Dish Network” is a trademark of EchoStar Satellite Corporation.

1. THE DISH NETWORK SERVICE

A. Services Defined. DISH Network offers a wide variety of video and audio programming and other services and we are constantly striving to add new services to our lineup. For purposes of this Agreement the term “Services” shall mean the programming available on DISH Network (whether subscription based or pay per view based) and any other services that we may provide to consumers either now or in the future. For purposes of this Agreement the terms “You” or “Your” refer to you, the DISH Network subscriber.

B. Programming Changes. Except as otherwise set forth in this Agreement, you may change your programming selection at any time by notifying us. A fee may apply to such changes (Change of Service Fee). In addition, you may be charged a fee (Service Access Fee) if you fail to subscribe to one of DISH Network’s basic programming packages which include America’s Top 50, America’s Top 100/CD, America’s Top 150, DISH Latino or DISH Latino Dos.

C. Programming Availability. Certain Services transmitted by us, including but not limited to some subscription Services, sporting events and broadcast network Services, may be blacked out in your area of reception. If you circumvent or attempt to circumvent any of these blackouts, you may be subject to legal action. You must be at least 18 years of age, or the applicable age of majority where you reside, in order to receive adult-oriented programming services.

D. Ordering Pay Per View. You may order DISH Network pay-per-view Services by using your on-screen Program Guide and remote control unit to select the movies and other events we offer. To order DISH Network pay-per-view Services, your DISH Network DBS digital receiver must be connected to a telephone outlet. You may also order DISH Network special events and pay-per-view Services over the telephone by calling the Customer Service Center or by using our automated system through the following toll free number:

1-877-DISH-PPV (3474-778) for ordering movies

A small fee will apply for use of the automated system (Pay-Per-View Automated Fee) or the Customer Service Center (Pay-Per-View Fee).

E. Private Viewing. DISH Network provides Services to you for your private home viewing, use and enjoyment. You agree that the Services provided will not be viewed outside of your private residence. You are permitted to exhibit the Services solely in your private residence and not in any other areas. The Services may not be rebroadcast, transmitted, recorded or performed, nor may admission be charged for listening to or viewing any Services provided by us. If we later determine that you utilized your DISH Network Equipment (including any additional DISH Network receivers) or sold, leased or otherwise gave possession of the same to a third party who you knew or reasonably should have known intended to use it to permit the viewing of the Services in a commercial establishment or any other area open to the public, we may terminate the Services and in addition to all other applicable fees, you agree to pay us the difference between the price actually paid for the Services and the full commercial rate for such Services, regardless of whether we have or had the commercial rights to such Services. The payment of that amount and/or the termination of Services shall not prejudice our ability to exercise any other rights and remedies we may have under this Agreement, at law, in equity, or otherwise.

F. Additional Receivers. To independently tune additional televisions within your home, a separate DISH Network receiver is required for each television. DISH Network will allow you to place up to five additional receivers on your account. Each additional receiver would be authorized to receive the same Services as your initial receiver. DISH Network will charge you a reduced monthly fee (Additional Receiver Authorization Fee) for each additional receiver added to your account. This option is only available if your initial DISH Network receiver and all additional receiver(s) are located at the same residence and are continuously connected to the same telephone line. If you desire to receive Services at two different locations, you must open a separate account for each location. You agree that you will not directly or indirectly use a single account for the purpose of authorizing Services for multiple DISH Network receivers that are not all located in the same residence and connected to the same phone line. If we later determine that you did, we may terminate your Services and, in addition to all other applicable fees, you agree to pay us the difference between the amounts actually received by us and the full retail price for the Services authorized for each DISH Network DBS receiver on the account, whether owned by you or not. The payment of that amount and/or the termination of Services shall not prejudice our ability to exercise any other rights and remedies we may have under this Agreement, at law, in equity, or otherwise.

G. Changes in Services offered. DISH Network reserves the right to change the Services that we offer, and our prices or fees related to such Services at any time. If the change affects you, we will provide you notice of the change and its effective date. The notice may be provided on your billing statement or by other communication permitted under Section 9B. In the event of a change in the contents of any programming, programming packages or other Services, you understand and agree that we have no obligation to replace or supplement the programming, programming packages or other Services previously offered that have been deleted, rearranged or otherwise changed. You further understand and agree you will not be entitled to any refund because of a change in the contents of any programming, programming packages, or other Services previously offered.

H. Multi-Month Subscriptions. For multi-month subscriptions, you may downgrade the Services only at the time of renewal. You may not downgrade the Services during the term of the multi-month subscription.

2. BILLING POLICIES AND PAYMENTS FOR SERVICES

A. You agree to pay all amounts billed for Services and to pay all taxes, fees and other charges, if any, which are now or may in the future be assessed on the Services you receive from us. Unless you prepay for a multi-month subscription to Services, we will bill you each month, in advance, for Services ordered by you or anyone who uses your DISH Network Equipment, whether with or without your permission, until you cancel the Services. The bills you receive will show the total amount due, the payment due date, payments, credits, purchases and other charges to your account.

B. You agree to pay us in full monthly by the payment due date for the Services and for any other charges due us, including any fees set forth in this Section 2. Payment of your bill after the due date will result in you paying us a Late Payment Fee. Other fees and charges may also be assessed. If partial payments are made, they will be applied first to the oldest outstanding bill. If you send checks or money orders marked "payment in full," we can accept them without losing any of our rights to collect any other amounts owed by you, notwithstanding your characterization of the payment. DISH Network does not extend credit to our customers, and the Late Payment Fee is not interest, a credit service charge or a finance charge. You understand and agree that in the case of late payment or nonpayment for any Services ordered by you or for any of the charges stated below, we may report such late payment or nonpayment to credit reporting agencies. If you do not pay your bill by the due date, we have the right to disconnect your Services at any time thereafter, in our sole discretion. DISH Network may require you to pay all past due charges, a Reconnect Fee, a deposit equal to a minimum of one month's advance charges and all outstanding balances accrued through the date of deactivation, before we reconnect your Services. Deposits will not be held segregated from other funds and shall not earn or accrue interest.

C. If you at any time fail, neglect, or refuse to make timely payments hereunder, or if a petition in bankruptcy shall be filed on your behalf or against you, or if you take advantage of any insolvency law or become insolvent or make an assignment for the benefit of creditors, or if a receiver, liquidator, or trustee is appointed for your property or affairs, we shall be wholly relieved from our obligations hereunder.

D. If you paid for an annual or other multi-month subscription to any Services and your account is past due for any amounts owed to us, at our option we may suspend any or all Service until payment is received, and/or convert your annual or other multi-month subscription to a monthly subscription. If we convert your multi-month subscription to a monthly subscription, we will first apply the amount you paid for your multi-month subscription to any past due amounts and then any remaining amounts to future obligations. If we elect to offset the amount paid for the remaining portion of a multi-month subscription against amounts past due, you agree to pay, in addition to all other applicable fees, the Offset Fee set forth below for each month and partial month that the multi-month subscription was previously received.

E. If we use a collection agency or attorney to collect money you owe us or to assert any other right which we may have against you, you agree to pay the reasonable costs of collection or other action. These costs might include, but are not limited to, the costs of a collection agency, reasonable attorney's fees and court costs. If there are billing errors or other requests for credit, you can contact our Customer Service Center by telephone or in writing. You must contact us within sixty (60) days of the time you receive the billing statement for which you are seeking corrections. Failure to timely notify us of a dispute shall constitute acceptance of the bill. Undisputed portions of the billing statement must be paid before the next billing statement is issued to avoid an administrative fee for late payment. All payments for Services must be made directly by you to us. DISH Network shall have no obligation to provide Services for which payment is made by you to a third party.

F. In addition to the amounts due for Services, you agree to pay the fees referenced below ("Fees") when applicable. DISH Network reserves the right to increase these Fees or add additional Fees in the future, in our sole discretion.

Smart Card Replacement Fee	\$50.00
Additional Receiver Authorization Fee (monthly, per receiver)	\$4.99
Late Payment Fee	\$5.00
Change of Service Fee	\$5.00
Duplicate Billing Statement Fee	\$2.00
Overnight Delivery Fee	\$18.00
Restart Fee	\$25.00
Returned Payment Fee	\$25.00
Service Access Fee (monthly)	\$5.00
Offset Fee	\$2.00
Ledger Request Fee	\$5.00
Pay-Per-View Automated Fee	\$1.00
Pay-Per-View Fee	\$5.00

3. CANCELLATION OF SERVICE

A. Your Service will continue until cancelled as provided for herein. Your subscription will be automatically renewed unless you contact us to cancel as provided for in the next paragraph.

B. You have the right to cancel your Service for any reason at any time by notifying us via telephone or in writing at the phone number or address set forth on page 1, above. Please be aware that certain promotional offers have a minimum subscription commitment (usually 12 months) and if you cancel your service prior to the expiration of that commitment, certain early termination fees may apply.

C. DISH Network has the right to terminate your Services at any time without providing notice to you if: (i) you fail to pay your bill when it is due; (ii) we receive confirmation that you have received the Services, or any part of the Services without paying for them; or (iii) you otherwise violate the terms of this Agreement.

D. If your Service is canceled for any reason, you are still responsible for payment of all outstanding balances accrued, including any applicable Fees.

E. You understand that charges for Services, once charged to your account, are nonrefundable. For monthly subscriptions, the cancellation will be effective at the end of the period covered by the last monthly bill. No refunds or credits will be provided in connection with the cancellation of monthly subscriptions. For annual or other multi-month subscriptions, the cancellation will be effective as of the date the multi-month subscription expires. Because you are receiving a discounted price in exchange for your agreement to pay for your services on an annual or other multi-month basis, in the event you cancel the Services prior to expiration of your multi-month subscription, you understand and agree that you are not entitled to any refund or credit for the unused portions of the multi-month subscription and that we have the right to retain any prepaid monies as liquidated damages.

4. EQUIPMENT

A. In order to receive the Services it will be necessary for you to purchase or lease certain reception equipment consisting primarily of a DISH Network compatible satellite receiver, a satellite antenna, LNBF unit and remote control ("Equipment"). You will also be provided with a conditional access card ("Smart Card") that is inserted into your satellite receiver. The Smart Card remains the property of EchoStar Communications Corporation, the corporate parent of DISH Network and any tampering or other unauthorized modification to the Smart Card is strictly prohibited and may result in, and subject you to, legal action. You agree to return the Smart Card to us upon request.

B. Smart Cards are nontransferable. Your Smart Card will only work in the DISH Network receiver to which it was assigned by DISH Network. If you report to the Customer Service Center that your Smart Card was lost, damaged, defective or stolen we will replace it, as long as there is no evidence of unauthorized tampering or modification. A replacement fee will apply. In addition, in order to minimize downtime for your Equipment, DISH Network will, upon your request, deliver a replacement Smart Card to you via overnight delivery. Our Overnight Delivery Fee will apply.

C. DISH Network reserves the right to alter software in your DISH Network receiver, and provide content to PVR products, through periodic downloads. DISH Network will use commercially reasonable efforts to schedule these downloads in a manner that result in the least amount of interference with or interruption to your Service.

D. Your DISH Network receiver contains certain components and software which are proprietary to DISH Network. You agree that you will not try to reverse-engineer, decompile or disassemble any software or hardware contained within your receiver or our Smart Card. Such actions are strictly prohibited and may result in the termination of your Services and/or legal action.

E. For proper operation of your Equipment, DISH Network requires that you connect each DISH Network receiver on your account to a telephone line. For accounts containing multiple receivers, each receiver must be connected to the same telephone line.

F. If your DISH Network Equipment is stolen or otherwise removed from your premises without your authorization, you must notify our Customer Service Center immediately, but in any event not more than three (3) business days after such removal to avoid liability for payment for unauthorized use of the DISH Network Equipment. You will not be liable for unauthorized use after we have received your timely notification.

5. LEASED EQUIPMENT

A. If you decide to lease your Equipment from DISH Network, such Equipment shall at all times remain the sole and exclusive property of DISH Network and we will have the right, at our discretion, to replace it with new or reconditioned equipment and to remove the equipment upon termination of Services. None of the equipment shall be deemed fixtures or part of your realty. Our ownership of the equipment may be displayed by notice contained on the equipment. You shall have no right to pledge, sell, mortgage, give away or remove, relocate, alter or tamper with the equipment (or any notice of our ownership thereon) at any time. Any reinstallation, return of or change in location of the equipment shall be performed by us at the service rates in effect at the time of service. You shall not attach any electrical or other devices to or otherwise alter the equipment without our prior written consent. DISH Network shall have the right to make such filings as are necessary to evidence our ownership rights in the equipment, and you agree to execute any and all documents as are necessary for us to make such filings. Upon termination of Services, you must notify our Customer Service Center to schedule the return the Equipment.

B. You shall notify us promptly of any defect in, damage to, or accident involving the equipment. All maintenance and repair of the equipment shall be performed by us or our designees. DISH Network may charge you for any repairs that are necessitated by any damage to, or misuse of, the Equipment.

6. TRANSFER OF ACCOUNT, SERVICES OR EQUIPMENT

DISH Network may sell, assign or transfer your account to a third party without notice to you. You may not assign or transfer your Services without our written consent which will not be unreasonably withheld. We may, however, refuse to allow you to assign or transfer your Services if you lease your Equipment or if your account has an outstanding balance.

7. LIMITATION OF OUR LIABILITY

A. WE WILL NOT BE LIABLE FOR ANY INTERRUPTIONS IN SERVICE OR LIABLE FOR ANY DELAY OR FAILURE TO PERFORM, IF SUCH DELAY OR NONPERFORMANCE ARISES IN CONNECTION WITH THE TERMINATION OF ALL OR A PORTION OF THE SERVICES, THE RELOCATION OF ALL OR A PORTION OF THE SERVICES TO DIFFERENT SATELLITE(S), A CHANGE IN THE FEATURES AVAILABLE WITH YOUR DISH NETWORK DBS EQUIPMENT OR ANY ACTS OF GOD, FIRES, EARTHQUAKES, FLOODS, POWER OR TECHNICAL FAILURE, ACTS OF ANY GOVERNMENTAL BODY OR ANY OTHER CAUSE BEYOND OUR CONTROL. WE WILL NOT BE LIABLE FOR ANY DAMAGE RESULTING FROM LOSS OF RECORDED MATERIAL OR THE PREVENTION OF RECORDING DUE TO ANY FAULT, FAILURE, DEFICIENCY OR DEFECT IN SERVICES OR EQUIPMENT. WE MAKE NO WARRANTY, EITHER EXPRESSED OR IMPLIED, REGARDING THE DISH NETWORK DBS EQUIPMENT OR ANY SERVICES FURNISHED TO YOU. ALL SUCH WARRANTIES ARE EXPRESSLY EXCLUDED. IN NO EVENT SHALL WE HAVE ANY LIABILITY FOR SPECIAL, INDIRECT, INCIDENTAL OR CONSEQUENTIAL DAMAGES RELATING TO THE DBS EQUIPMENT OR RESULTING FROM OUR FURNISHING OR FAILURE TO FURNISH ANY SERVICES OR EQUIPMENT TO YOU, OR FROM ANY FAULT, FAILURE, DEFICIENCY OR DEFECT IN SERVICES OR EQUIPMENT FURNISHED TO YOU.

B. It is your responsibility to impose any restrictions on viewing by you, other members of your household, or guests, and we shall have no liability to anyone due to or based on the content of any of the Services furnished to you.

8. WARNING AGAINST PIRACY

It is a violation of several U.S. federal and state laws to receive any Services, or any portion of such Services, without paying for them. The penalties for violating such laws can range from imprisonment to civil damage awards of up to \$110,000 per violation.

9. MISCELLANEOUS

A. Physical Address/Change of Address. When setting up your DISH Network account, you agree to provide us with the physical street address where the Equipment will be located. A post office box does not constitute a physical address and is not sufficient to meet this requirement. You agree to give us prompt notice of your change of name, mailing address, physical address where the Equipment is located or telephone number. You may do this by notifying our Customer Service Center by telephone or in writing.

B. Notice. If we send you notice, it will be considered given when deposited in the U.S. Mail, addressed to you at your billing address or hand-delivered to you. Our notice to you will also be effective if provided on your billing statement or by telephone. If you give notice to us, it will be deemed given when received by us at the address listed on the first page of this Agreement.

C. Applicable Law. This Agreement, including all matters relating to its validity, construction, performance and enforcement, shall be governed by applicable federal law, the rules and regulations of the Federal Communications Commission, and the laws and regulations of the state and local area where Service is provided. These terms and conditions are subject to amendment, modification or termination if required by such regulations or laws. If any provision in this Agreement is declared to be illegal or in conflict with any law or regulation, that provision may be deleted or modified, without affecting the validity of the other provisions.

D. Other. This document contains the entire agreement between DISH Network and you, the customer, and no salesperson, installer, customer service representative, authorized retailer, or other similarly situated individual is authorized to change the terms set forth herein. DISH Network may, however, change the terms and conditions of this Agreement in the future and will notify you if that occurs. The terms of this Agreement, which either are expressly stated to survive or by their nature would logically be expected to survive termination, shall continue thereafter until fully performed.

Staying Legal

Title 47, Section 605(e)4, United States Code (U.S.C.) makes it a federal crime to modify this receiver to enable it to receive encrypted (scrambled) television programming without payment of required subscriptions. Conviction can result in a fine of up to \$500,000 and imprisonment for five years, or both. Any owner of this receiver who procures or willfully causes its modification is an accessory to that offense and may be punishable in the same manner. Investigative authority for violations lies with the Federal Bureau of Investigation (FBI).

This product may incorporate copyright protection technology that is protected by U.S. patents and other intellectual property rights. Use of such copyright protection technology must be authorized by Macrovision, and is intended for home and other limited pay-per-view uses only unless otherwise authorized by Macrovision. Reverse engineering or disassembly is prohibited.

FCC Compliance



The following text is extracted from Federal Communications Commission (FCC) regulations, as of the publication date of this *Guide*. Contact the FCC (see following) or your library for the complete text of the regulations.

Telephone Communication

This equipment complies with Part 68 of the FCC rules. On the rear panel of this equipment is a label that contains, among other information, the FCC registration number and ringer equivalence number (REN) for this equipment. If requested, this information must be provided to the telephone company.

The REN is used to determine the quantity of devices which may be connected to the telephone line. Excessive RENs on the telephone line may result in the devices not ringing in response to an incoming call. In most, but not all areas, the sum of the RENs should not exceed five (5.0). To be certain of the number of devices that may be connected to the line, as determined by the total RENs, contact the telephone company to determine the maximum REN for the calling area.

REN for this equipment: **0.0**

This equipment uses the following Universal Service Order Code (USOC) jacks: RJ-11C.

A plug and jack used to connect this equipment to the premises wiring and telephone network must comply with the applicable FCC Part 68 rules and requirements adopted by the ACTA. A compliant telephone cord and modular plug is provided with this product. It is designed to be connected to a compatible modular jack that is also compliant. See installation instructions for details.

Connection to party line service is subject to state tariffs. Contact the state public utility commission, public service commission or corporation commission for information.

If your home has specially wired alarm equipment connected to the telephone line, ensure the installation of this [equipment ID] does not disable your alarm equipment. If you have questions about what will disable alarm equipment, consult your telephone company or a qualified installer.

A plug and jack used to connect this equipment to the premises wiring and telephone network must comply with the applicable FCC Part 68 rules and requirements adopted by the ACTA. A compliant telephone cord and modular plug is provided with this product. It is designed to be connected to a compatible modular jack that is also compliant. See installation instructions for details.

If this equipment causes harm to the telephone network, the telephone company will notify you in advance that temporary discontinuance of service may be required. If advance notice is not practical, the telephone company will notify the customer as soon as possible. Also, you will be advised of your right to file a complaint with the FCC if you believe it is necessary.

The telephone company may make changes in its facilities, equipment, operations, or procedures that could affect the operation of the equipment. If this happens, the telephone company will provide advance notice in order for you to make the necessary modifications in order to maintain uninterrupted service.

If you experience trouble with this equipment, please contact Customer Service at 1-800-333-3474 for repair and warranty information. If the trouble is causing harm to the telephone network, the telephone company may request you remove the equipment from the network until the problem is resolved.



There are no customer repairable parts inside. Any attempts to repair the receiver will void your authorization to use it.

Radio Interference

This device complies with Part 15 of the FCC Rules. Operation is subject to the following two conditions:

1. this device may not cause harmful interference, and
2. this device must accept any interference received, including interference that may cause undesired operation.

Modifying this receiver may void your authority to use the equipment.

This equipment has been tested and found to comply with the limits for a Class B digital device, pursuant to Part 15 of the FCC Rules. These limits are designed to provide reasonable protection against harmful interference in a residential installation. This equipment generates, uses and can radiate radio frequency energy and, if not installed and used in accordance with the instructions, may cause harmful interference to radio communications. However, there is no guarantee that interference will not occur in a particular installation. If this equipment does cause harmful interference to radio or television reception, which can be determined by turning the equipment off and on, the user is encouraged to try to correct the interference by one or more of the following measures:

- Reorient or relocate the receiving antenna.
- Increase the separation between the equipment and receiver.
- Connect the equipment into an outlet on a circuit different from that to which the receiver is connected.
- Consult the dealer or an experienced radio/TV technician for help.

Refer to *Troubleshooting* in *Chapter 3* for a detailed description of recommended customer actions.

If none of the remedies on the previous page stops the radio interference, you should contact a licensed radio/television technician, your satellite dealer, or call the Customer Service Center at 1-800-333-3474, for assistance.

Index

A

- Accessory Jack
 - Set Up the Accessory Jack 81
- Adult Channels
 - Hide or Show All Adult Channels 47
- Audio
 - Change Program Languages 80
 - Dolby® Digital Sound 59
- Auto Recording 61, 66
- Automatic Event Timers 48
 - Set an Automatic Event Timer 51

B

- Back Panel, Receiver 17
- Blacked-Out Program 56
- Browse Banner 34
- Buttons, Receiver Front Panel 15
- Buttons, Remote Control 22, 72

C

- Caller ID 58
- Cancel a Procedure 28
- Change Channels 31
- Change Program Languages 80

D

- Device Codes
 - Check the Device Codes 71
 - Scan for Device Codes 70
 - Try the Device Codes 69
- DishDVR 1, 60, 66
 - Auto Record and On-Demand Record at the Same Time 61, 66
 - Copy Recordings to Videotape 67
 - DishDVR Recorded Events Menu 63
 - On-Demand Recording 62, 66
 - Play Back Locked Programs 56
 - Protect a Recorded Program 48, 51, 53, 54
 - Recorded Event's Info Menu 63
- Dolby® Digital Sound 59

E

- Event Timers 48
 - Automatic Event Timers 48
 - Control a VCR 56
 - Delete an Event Timer 55
 - Edit an Event Timer 54
 - Event Timer Frequencies 49

- Event Timer Types 49
- How Many Event Timers You Can Set 56
- Manual Event Timers 48
- Pay Per View Programs, Locked Programs, and Blacked-Out Programs 56
- Power Off and Event Timers 56
- Quick Record 50
- Set a Manual Event Timer 52
- Set an Automatic Event Timer 51
- Start One Minute Early Check Box 50
- When an Event Timer Works 50
- When Event Timers Overlap 53

F

- Fan, Receiver 17
- Favorite Lists 38
 - Apply a Favorite List 40
 - Change a Favorite List's Name 39
 - If You Reset the Receiver 80
 - Set Up or Change a Favorite List 39
- Feature Upgrades 79
- Federal Communications Commission (FCC) Compliance
 - Radio Interference 138
 - Telephone Communication 137
- Front Panel, Receiver 15

L

- Languages
 - Change Program Languages 80
- Legal Notices 136
- Limited Warranty 127
- Locks 42
 - Buy a Pay Per View Program 36
 - Change the Password 43
 - Hide or Show All Adult Channels 47
 - If You Forget the Password 43
 - If You Reset the Receiver 80
 - Pay Per View Programs, Locked Programs, and Blacked-Out Programs 56
 - Rating Code Locks 43
 - Set a Manual Event Timer for a Locked Program 56
 - Set an Automatic Event Timer for a Locked Program 56
 - Set or Change Channel Locks 45

M

Manual Event Timers 48

O

On-Demand Recording 62, 66
 DishDVR Recorded Events Menu 63
 Once You've Made One or More Recordings 63
 Play Back Locked Programs 56
 Protect a Recorded Program 51, 53, 54
 Recorded Event's Info Menu 63
 Start Recording a Program 62
 Stop Recording a Program 63
 Use an Event Timer 63

P

Password
 Change the Password 43
 Pay Per View Programs
 Buy a Pay Per View Program 36
 Lock or Unlock All Pay Per View Programs 46
 Personal Identification Number (PIN) 48
 Program Banner 34
 Program Guide 31
 Programs
 Browse Banner 34
 Display the Last Channel You Watched in the Program Guide 32
 Order Your Program Packages 3
 Program Banner 34
 Program Guide 31
 Select a Program in the Program Guide 33

Q

Quick Record 50
 Quick Tour of Basic Features 4
 Quick Tour of DishPVR Features 10
 Quick Tour of Menus 6

R

Radio Interference 138
 Rating Code Locks 43
 Set or Change Rating Code Locks 44
 Receiver 15
 Address, Change the 26
 Attenuator, Install an 19
 Back Panel 17
 Back Panel Ports 17
 Control a VCR 56
 Front Panel 15
 Front Panel Buttons 15
 Lock or Unlock the Receiver 47

Menus 27
 Radio Interference 138
 Reset the Receiver 80
 Set Up the Accessory Jack 81
 Telephone Communication 137

Receiver Back Panel 17
 Receiver Front Panel 15
 Receiver Menus 27
 Cancel a Procedure 28
 Make a Choice in a Menu 27
 Open or Close a Menu 27
 Remote Control 20
 Address, Change the 26
 Attenuator, Install an 19
 Batteries 21
 Buttons 22, 72
 Control Devices with the Remote 68
 Device Codes, Check the 71
 Device Codes, Scan for 70
 Device Codes 69
 Modes 68
 Other Features 77
 Set Up the Remote to Control Devices 68
 Switch Between TV and Device
 Volume Control 77

S

Search Feature - How to Use 40
 Special Events Recording Feature 2
 Stay Legal
 Be Careful About Recording Copyrighted Programs and Films 48, 60, 67
 Staying Legal 136

T

Test the System 119
 Themes 37
 Troubleshoot the System 105
 Channel Changes 106
 DishPVR Features 106
 Dolby Digital Sound 107
 Event Timers 107
 Favorite Lists 110
 Locks 110
 Menus 111
 On-Screen Messages 112
 Pay Per View 115
 Phone 115
 Picture 116
 Remote Control 117
 Test the System 119

U

Upgrade the Receiver Software 79
 Get a Software Upgrade 79
 Set Up the Receiver to Tell You About Upgrades 79

Write the following information in the spaces provided below. You may need to provide this information if you call the Service Center. To get the Conditional Access Numbers, display the **Important System Information** menu (see *Ordering Your Program Packages*).

Purchase Location Name:	
Purchase Location Telephone Number:	
Receiver Serial Number:	
Receiver Conditional Access Number	
Smart Card Conditional Access Number:	

Codes Programmed into Remote Control	
Remote Address (SAT Mode)	
Television Code (TV Mode)	
VCR Code (VCR Mode)	
Auxiliary Code (AUX Mode)	

U.S. Patent No's 4631603, 4577216, 4819098 are licensed for limited pay per view only.

This product incorporates copyright protection technology that is protected by U.S. patents and other intellectual property rights. Use of this copyright protection technology must be authorized by Macrovision, and is intended for home and other limited pay per view uses only unless otherwise authorized by Macrovision. Reverse engineering or disassembly is prohibited.

To subscribe to programming,
or for assistance with
installing or using the system,
call Customer Service at
1-800-333-DISH(3474)



Free Manuals Download Website

<http://myh66.com>

<http://usermanuals.us>

<http://www.somanuals.com>

<http://www.4manuals.cc>

<http://www.manual-lib.com>

<http://www.404manual.com>

<http://www.luxmanual.com>

<http://aubethermostatmanual.com>

Golf course search by state

<http://golfingnear.com>

Email search by domain

<http://emailbydomain.com>

Auto manuals search

<http://auto.somanuals.com>

TV manuals search

<http://tv.somanuals.com>