



ZEETER™

**Safety Instructions
&
Operator's Manual**

IMPORTANT - READ CAREFULLY

The Dixon® ZTR® mower is both easy and fun to operate. However, any power mower must be operated properly to be safe. It is not a toy or a recreational vehicle. Before you start to use the mower, read this Operator's Manual carefully. It contains valuable information that is necessary for the safe operation of the machine. Observe all safety rules and become completely familiar with the controls.

The information contained in this manual applies to all Dixon® ZEETER™ mowers.

See your authorized Dixon® dealer for warranty service, parts and repairs or to answer any questions you may have about your new Dixon® ZTR®.

TABLE OF CONTENTS

	<u>Page</u>
SAFETY & WARNING.....	4-15
WARRANTY.....	16
SPECIFICATIONS.....	17
CONTROLS.....	18-22
OPERATION INSTRUCTIONS.....	23-31
CARE & MAINTENANCE.....	32-44
STANDARD SERVICE PARTS LIST.....	45
TROUBLESHOOTING.....	46-47

ZEETER™
Part Number 14295-1005

SAFETY

**⚠ RIDING LAWN MOWERS,
IF IMPROPERLY OPERATED
CAN CAUSE SERIOUS INJURY OR DEATH**

Pictured below are the most common causes of injury to the operator or bystander. Please read and understand this manual to prevent injuries.

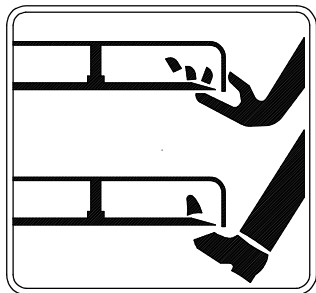

Blade Contact

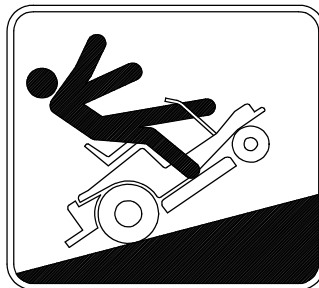

Tip Over

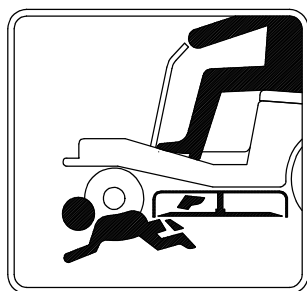

Run Over



Back Over

SAFETY



Safety Alert Symbol

When you see this symbol, BE ALERT to the potential for injury.

Follow the recommended safety precautions and safe operating practices.



DANGER
(highlighted in red)
indicates an imminently hazardous situation which, if not avoided, will result in death or serious injury.



WARNING
(highlighted in orange)
indicates a potentially hazardous situation which, if not avoided, could result in death or serious injury.



CAUTION
(highlighted in yellow)
indicates a potentially hazardous situation which, if not avoided, may result in minor or moderate injury. It may also be used to alert against unsafe practices.

WARNING

 ***Failure to observe the following safety instructions could result in serious injury or death.***

GENERAL OPERATION:

Read, understand, and follow all instructions in this manual and on the mower before starting.

Only allow responsible adults, who are familiar with the instructions, to operate the mower.

Clear the area of objects such as rocks, toys, wire, etc., which could be picked up and thrown by the blade.

Be sure the area is clear of other people before mowing. Stop mower if anyone enters the area.

Be aware of the mower discharge direction and do not point it at anyone. Mower blades can throw rocks or other debris.

Do not operate the mower without either the entire grass catcher or the deflector in place. This will decrease the possibility of injury from objects being thrown by the mower blades.

Never carry passengers. They may fall off and become seriously injured or interfere with safe operation of the mower.

Mowing in reverse is not recommended because it is difficult to maintain a clear vision of the mowing path. However, should it become necessary to back up, remember to look down and behind before and while backing.

WARNING

 **Failure to observe the following safety instructions could result in serious injury or death.**

GENERAL OPERATION (continued):

Never leave a running mower unattended. Always turn off blades, set parking brake, stop engine and remove key before dismounting.

Turn off blades when not mowing. Injury could occur from contact with moving parts.

Under no circumstances should you place hands or feet under the mower deck or in the chute while blades or impeller are still running.

To avoid personal injury from accidental clutch engagement, stop engine before removing grass catcher or unclogging chute.

Mow only in daylight or good artificial light.

Do not operate the mower while under the influence of alcohol or drugs.

Slow down before turning to reduce the risk of tip-over.

Watch for traffic when operating near or crossing roadways.

Use extra care when loading or unloading the mower into a trailer or truck. Push, do not ride the mower when loading and unloading.

WARNING

 **Failure to observe the following safety instructions could result in serious injury or death.**

GENERAL OPERATION (continued):

Never dismount mower without applying parking brake or stopping engine.

Protect your eyes. Always wear safety goggles or safety glasses with side shields when operating mower.

Data indicates that operators, age 60 years and above, are involved in a large percentage of riding mower-related injuries. These operators should evaluate their ability to operate the riding mower safely enough to protect themselves and others from serious injury.

To protect against possible tip-over, follow the manufacturer's recommendation for wheel weights and counterweights.

Maintain or replace safety & instruction labels as needed.

The engine exhaust from this product contains chemicals known to the State of California to cause cancer, birth defects or other reproductive harm.

WARNING

 **Failure to observe the following safety instructions could result in serious injury or death.**

SLOPE OPERATION:

Slopes are a major factor related to loss-of-control and tip-over accidents, which can result in severe injury or death.

All slopes require extra caution. If you feel uneasy on a slope, do not mow it!

DO

Mow across the slope with your Dixon® ZTR® -- never up or down. This will decrease the risk of tip-over.

Remove obstacles such as rocks, tree limbs, wires and other foreign objects that can be thrown by mower blades.

Watch for holes, ruts, roots and bumps. Uneven terrain could overturn the mower. Tall grass can hide such obstacles.

Use slow speed. Tires may lose traction on slopes even though the brakes are functioning properly.

Avoid starting or stopping on a slope. If tires lose traction, disengage the blades and proceed slowly down the slope.

WARNING

 ***Failure to observe the following safety instructions could result in serious injury or death.***

SLOPE OPERATION (continued):

DO (continued):

Keep all movement on the slopes slow and gradual. Do not make sudden changes in speed or direction.

Use extreme caution when operating the mower with attachments to prevent tip-over or roll-over.

If front wheels lift off the ground, pull levers back to stabilize the mower. Discontinue mowing the slope!

WARNING

 **Failure to observe the following safety instructions could result in serious injury or death.**

SLOPE OPERATION (continued):

DO NOT

Do not turn on slopes unless necessary, and then, turn slowly and gradually downhill, if possible. Rapid uphill turns may cause tip-over.

Do not mow near drop-offs, ditches, or embankments. The mower could suddenly turn over if a wheel is over the edge of a cliff or ditch or if an edge caves in.

Do not mow on wet grass. Reduced traction could cause sliding.

Do not try to stabilize the mower by putting your foot on the ground.

Do not use grass catcher or other attachments on steep slopes. The added weight may change the stability of the mower thus creating the potential for tip-over.

WARNING

 ***Failure to observe the following safety instructions could result in serious injury or death.***

FIRE HAZARDS:

Use extra care when handling gasoline and other fuels. They are flammable and vapors are explosive.

Store all fuel in approved containers specifically designed for that purpose.

Allow engine to cool before refueling. Never remove fuel cap or add fuel with engine running.

Do not smoke while refueling or operating the mower.

To reduce fire hazard, keep mower free of grass, leaves and other debris build-up.

If gasoline is spilled, do not attempt to start the engine. Move mower away from the area of the spill. Do not create any source of ignition until gas vapors have dissipated. Wipe up spilled fuel and dispose of waste properly.

If fuel is spilled on clothing, change clothing immediately.

Before storing, allow mower to cool. Clean fuel and oil spillage.

Never store the mower or fuel container inside a building where there is an open flame.

WARNING

 **Failure to observe the following safety instructions could result in serious injury or death.**

FIRE HAZARDS (continued):

To prevent fire or explosion, keep sparks and open flames away from battery.

Keep electrical connections clean and tight. Inspect them often. Loose connections and corrosion increase fire risk.

Before disconnecting the negative ground cable, make sure all switches are off. This decreases the chance of sparking and fire.

Use care when backing to avoid pushing the grass bags into the frame or “hot” exhaust muffler of the engine. Fire could result.

To prevent fire and explosion caused by static electricity:

Never fill containers inside a vehicle or on a truck or trailer bed with a plastic liner. Always place containers on the ground away from your vehicle before filling.

When practical, remove fuel powered equipment from the truck or trailer and refuel it on the ground. If this is not possible, refuel such equipment on a trailer with a portable container, rather than from a fuel dispenser nozzle.

If a fuel dispenser nozzle must be used, keep the nozzle in contact with the rim of the fuel tank or container opening at all times until fueling is complete. Do not use a nozzle lock-open device.

WARNING

 **Failure to observe the following safety instructions could result in serious injury or death.**

CHILDREN:

Tragic accidents can occur if the operator is not alert to the presence of children.

Children are attracted to lawn mowers and the mowing activity.

NEVER assume children will stay where they were last seen.

Be alert to avoid accidents.

Keep children out of the mowing area and under the watchful care of another responsible adult.

Be alert and turn mower off if a child enters the area.

Before and during backing look BEHIND and DOWN for small children.

Never carry children. They may fall off and be seriously injured or interfere with safe mower operation.

Never allow children to operate the mower.

Use extra care when approaching blind corners, shrubs, trees, or other objects that may obscure vision.

WARNING

 ***Failure to observe the following safety instructions could result in serious injury or death.***

SERVICE:

Never run a mower inside a closed area or without proper ventilation.

Keep nuts and bolts tight, especially blade attachment bolts, and keep equipment in good condition.

Never tamper with safety devices. Check their proper operation regularly.

Stop and inspect the equipment if you strike an object. Repair, if necessary, before restarting.

Never make adjustments or repairs with the engine running unless otherwise specified.

Grass catcher components are subject to wear, damage and deterioration which could expose moving parts or allow objects to be thrown. Frequently check components. Replace with original equipment parts when necessary.

Mower blades are sharp and can cut. Wrap blades or wear gloves, and use extra caution when servicing them.

Batteries contain sulfuric acid. To prevent burns, avoid contact with skin, eyes and clothing.

DIXON® ZTR® RESIDENTIAL WARRANTY POLICY

ZEETER™ - Residential Mower

DIXON® WARRANTS ITS ZTR® MOWERS AGAINST DEFECTS IN MATERIAL AND WORKMANSHIP FOR THE PERIODS SET FORTH BELOW. THE SOLE REMEDY UNDER THIS WARRANTY IS REPLACEMENT OR REPAIR OF PARTS INCLUDING LABOR COSTS. THIS WARRANTY IS SUBJECT TO THE FOLLOWING CONDITIONS AND LIMITATIONS:

1. RESIDENTIAL APPLICATION - (used only at owner's primary place of residence):
 - a. Two Years - 100% parts and labor subject to the conditions and limitations described herein for a period of two years from date of purchase by the original owner.
 - b. Attachments marketed through or approved by Dixon Industries, Inc., are warranted for two years parts and labor in residential use applications.
2. NOT APPROVED FOR COMMERCIAL USE.
3. All Dixon® warranty must be accomplished by authorized Dixon® dealers and in accordance with Dixon® warranty policy and allowances. All warranty claims must be submitted to Dixon Industries for approval.
4. Warranty applies to new and unused mowers and ***is transferable*** within the stated time frame to a second owner.
5. Warranty labor reimbursement to dealers based on published Dixon® flat rate schedule.
6. Warranty does not apply to damage in transit or incidents of misuse, negligence, accidents, or alteration. The use of parts or components other than those supplied by Dixon Industries VOIDS ALL WARRANTY.
7. Battery warranty is limited to one year from mower manufacture date.
8. The following items are not covered by this warranty policy:
 - (a) Routine maintenance or adjustments to include any oils, filters or other fluids used.
 - (b) Belts, blades and tires.
 - (c) Pick up and delivery charges for transportation of mower to and from an authorized Dixon® dealer's place of business.
 - (d) Engines. These are covered under a separate warranty by each individual engine manufacturer. Consult engine manual for warranty details.
 - (e) Any costs or expense of providing substitute equipment while repair work is being performed on a warranted mower.
9. THERE IS NO OTHER EXPRESS WARRANTY. TO THE EXTENT PERMITTED BY LAW, ALL IMPLIED WARRANTIES, INCLUDING THOSE OF MERCHANTABILITY AND FITNESS FOR A PARTICULAR PURPOSE ARE EXCLUDED, OTHERWISE, ALL SUCH IMPLIED WARRANTIES ARE LIMITED TO THE SAME DURATION AND REMEDIES AS THE EXPRESS WARRANTY. ALL LIABILITIES FOR CONSEQUENTIAL DAMAGES UNDER ANY EXPRESS OR IMPLIED WARRANTY ARE EXCLUDED.

SPECIFICATIONS

CHASSIS:	11 GA welded channel frame	
BODY:	All body parts made of rotational molded polyethylene. Front body contains access panel for battery service. Seat tilts forward to allow transmission service.	
MOWERDECK:	11 GA stamped steel construction. Single 30" cut blade. Cut height approximately 1-1/2" - 4" via 7-position lift handle.	
BLADEDRIE:	Mechanical; hand lever engagement	
TRANSMISSION:	Each rear wheel is independently driven by chain and sprockets through a friction mechanical drive.	
ENGINE:	11HP Briggs & Stratton I/C, 4-cycle, single cylinder, air-cooled, gasoline, vertical shaft, aluminum head and block.	
STARTINGSYSTEM:	Electric by key switch operation with safety interlocks on parking brake and blade drive.	
TIRES:	Front	9 x 3.50-4 Smooth Tread
	Rear	16 x 6.50-8 Turf Saver
RECOMMENDED TIREPRESSURE:	Front	16-21 PSI
	Rear	8-14 PSI
CAPACITIES:	Fuel	3 quart
	Engine	1.25 quarts oil
DIMENSIONS:	Width	32" outside rear wheel measurement
	Width	40" overall width of deck with deflector
	Height	31" to top edge of seat
	Length	65.5" hitch tab to front
	Weight	390 lbs.

Additional information may be provided elsewhere in this manual.

SPECIFICATIONS SUBJECT TO CHANGE WITHOUT NOTICE

CONTROLS

CONTROL LEVERS

TO GO FORWARD

- From neutral position, gently push control levers forward.
- To increase speed, move levers further forward.

TO GO BACKWARDS

- From neutral position, gently pull control levers toward you.

TURNING

- Turning is controlled by moving one control lever slightly forward or rearward of the other.
- To turn left, move left lever rearward of the right lever.
- To turn right, move right lever rearward of the left lever.
- To turn on mower's own axis (zero turning radius), stop and move one lever to reverse position and the other to forward position.

BRAKING

- To brake mower, move both levers in direction opposite of travel.

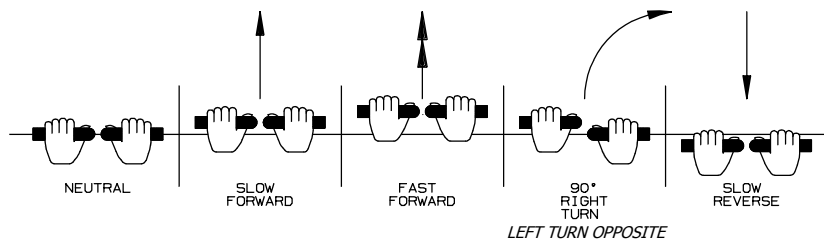

Note: The pressure required to operate the mower is very light.

CONTROLS

PARKING BRAKE:

The parking brake is designed to hold the mower from moving and is not intended for use in stopping the mower while it is in motion. The engine will stop if the parking brake is engaged while the control levers are in the drive position.

 **CAUTION** Engage parking brake before starting engine.



TO SET PARKING BRAKE:

The hand operated parking brake is located on the right side of the mower.

- To engage brake, pull lever up (to the rear).
- To release brake, move lever forward (down).

Note: Always set parking brake before dismounting.
Release parking brake before moving mower.

CONTROLS

BEFORE OPERATING MOWER:

1. Read engine manufacturer's operating and maintenance instructions.
2. Read and observe all safety instructions on your mower and in the manual.
3. Check engine oil.
4. Check fuel cap to be sure it is in place.
5. Be sure parking brake is on.
6. Be sure mower blade drive is off.
7. Know how to stop engine. (Turn key to off position).

CONTROLS

The Dixon® ZEETER™ has a unique transaxle that requires only two drive levers to control braking, turning, speed and direction.

On initial operation set throttle speed to slow. Operate with mower blade in “OFF” position.

To avoid “over-controlling” the mower, use a light touch on the drive levers.

Slight movements using fingertip control is all that is necessary.

TRANSMISSION DRIVE SYSTEM

Allows the mower to turn on its own axis “ZERO TURNING RADIUS”. Each lever controls one side of the mower.

Note: The pressure required to operate the mower is very light.

TOWING TRAILERS AND OTHER ATTACHMENTS:

Towing a trailer or other attachment that is too heavy could damage the drive or cause the mower to become unstable. Limit loads to 250 pounds or less with this mower.

CONTROLS

BLADE DRIVE:

- Located to the left of the operator.
- To engage the mower blade, turn lever on floor slowly to the “ON” position.
- To disengage mower blade, turn lever to the “OFF” position.

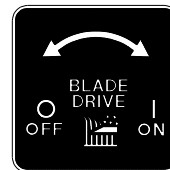

THROTTLE CONTROL LEVER:

- Located on control panel to operator's right.
- Throttle control for engine speed.
- Choke for engine starting.
- Throttle control should be set to MAXIMUM or wide open setting to insure adequate cooling of the engine and to maintain mower deck blade speed while mowing.

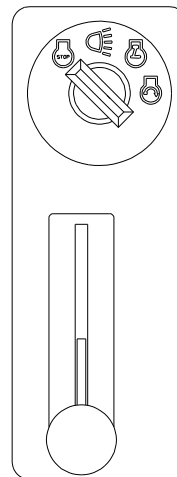

MOWER DECK CUT HEIGHT LIFT LEVER:

- Located to the left of the operator.
- Controls the cutting height.
- Seven positions of adjustment.
- Move lever in and forward to lower.
- Move lever in and back to raise.

Note: Always use high for transport.

OPERATION INSTRUCTIONS

The safe and successful operation of the ZEETER™ mower will depend upon the operator having the correct knowledge of all controls used on the mower and making good judgements about the terrain to be mowed.

NEVER allow anyone to operate the mower without complete knowledge of all controls and their functions.

NEVER dismount mower without applying parking brake or stopping engine.

During initial operation, “learning to drive”, set throttle at slow speed.

Sound judgement by the operator will prevent accidents.

OPERATION INSTRUCTIONS



CAUTION Failure to follow these instructions may result in personal injury.

STARTING INSTRUCTIONS:

1. Parking brake must be on and blade drive disengaged.
2. Position throttle lever to 1/2 speed setting. If engine is cold, position lever to the choke position.

NOTE: Engine may require choke setting to start even if the engine has been operated for a period of time.

3. Insert ignition key and turn to "start" position. When engine starts, release ignition key. Key will return to "run" position.
4. Move "throttle" from choke to maximum speed position.
5. Release parking brake.
6. Operate mower per "CONTROLS" instructions on Page 18.



CAUTION Do not operate the engine in an enclosed area due to the harmful exhaust gas produced.

Note: When mowing with blades engaged, set throttle control to the MAXIMUM or wide open setting to insure adequate cooling of the engine and to maintain mower deck blade speed.

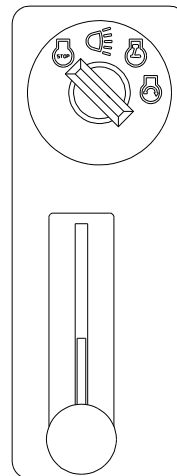

OPERATION INSTRUCTIONS

TESTING OF SAFETY INTERLOCK SYSTEMS:



Failure to observe the following testing instructions could result in serious injury or death.

The following tests should be performed at the start of each mowing day.

PARKING BRAKE SWITCH TEST:

- a) Put parking brake in OFF position
- b) Turn ignition switch to START

Engine should not turn over or attempt to start.

BLADE DRIVE SWITCH TEST:

- a) Put parking brake in ON position
- b) Engage blade drive switch.
- c) Turn ignition switch to START.

Engine should not turn over or attempt to start.

SEAT SWITCH TEST:

- a) In a safe area away from bystanders, start the engine.
- b) Engage blade drive switch.
- c) Raise slightly off seat.

Engine should STOP!

NOTE: If any safety check fails, do not operate the mower until the system has been checked and repaired by an Authorized Dixon® Dealer!

OPERATION INSTRUCTIONS

MOWING WITH A MULCHING ATTACHMENT:

Mulching or recycling the grass clippings requires a totally different mowing approach than would be normal when side discharging or bagging the grass. There may be instances or conditions where it is not possible to hide all the recycled or mulched clippings.

In order to achieve the best results, please read and follow the mulching tips listed below:

1. Read and follow the installation instructions that are included with your mulcher.
2. Set the engine speed control to the wide open or full setting.
3. Place the mower deck cut height selector in either the top or second notch. Never cut more than 3/4" to 1" off the grass at any one time. Attempting to cut more grass will result in the deck plugging and cause the engine to stall.
4. It may be necessary to cut the lawn twice to achieve acceptable mulching performance especially on first cuttings or if the lawn is heavily fertilized.
5. *Do not attempt to cut grass when it is wet.* Mulching performance will be very poor in wet grass conditions.
6. *Maintain sharp blades throughout the cutting season.* This is very important. Optimal mulching performance cannot be obtained with a dull or nicked up blade.

OPERATION INSTRUCTIONS

MOWING WITH A MULCHING ATTACHMENT (continued):

7. *Keep the underside of the mower deck clean.*
Remove all grass and dirt build-up from the underside of the pan, the baffles and deflectors after each use. **Never, under any circumstances, should you place hands or feet under the mower deck or in the chute while blades or impeller are still turning.**

8. Alternate mower direction. This will evenly disperse the mulched grass clippings over the lawn for even fertilization.

If the mulching quality of the mower does not seem to be satisfactory, try one or more of the following tips:

- a. Raise the height-of-cut setting on your mower.

- b. It may be necessary to cut your grass more frequently.

- c. Operate the mower at a slower ground speed.

- d. Overlap cutting swaths instead of cutting a full swath with each pass.

- e. Mow across the marginal areas a second time.

- f. CUT HIGH - MOW OFTEN!

OPERATION INSTRUCTIONS

MOWING WITH A GRASS CATCHER ATTACHMENT:

In order to achieve optimum performance when mowing with a grass catching attachment, please read and follow the tips listed below.

1. Read and follow the installation instructions that are included with your grass catcher.
2. Set engine speed control to the wide open or full setting.
3. *Do not attempt to cut grass when it is wet.* Wet grass will clog both the underside of the deck and the attachment chutes. Empty bags often to prevent plugging.
4. If the grass is tall, place the mower deck cut height selector in the top or second notch. "Initially" overlap cutting swaths instead of a full swath with each pass.
5. *Keep the underside of the mower deck clean.* Frequent removal of dried grass and dirt will greatly assist in bagging of the clippings. **Never, under any circumstances, should you place hands or feet under the mower deck or in the chute while blades or impeller are still turning.**
6. Operate the mower at a slower ground speed than when mowing without a grass catching attachment.

OPERATION INSTRUCTIONS

MOWING WITH A GRASS CATCHER ATTACHMENT (continued):

7. *Maintain sharp blades throughout the cutting season.* Some grass catching attachments require a “high-lift” blade. See your dealer for advice on the type of blade(s) needed for your mower.
8. Some mowing applications/use of grass catchers may require that an additional weight kit be fitted to the mower to counter the weight of grass in the bags. Please consult with your dealer for more information regarding installation and adding weight to the box.



WARNING Failure to observe the following instructions may result in personal injury.

- Watch for low hanging branches or other obstacles which might hit the catcher top while turning or backing the mower.
- Use care when backing to avoid pushing the grass bags into the frame or “hot” exhaust muffler of the engine. Fire could result.
- Disengage blade and stop engine prior to clearing grass from either the discharge chute or grass catcher components.
- Do not operate the mower with the grass catching attachment partially removed. Operator or bystanders could be injured by thrown objects.
- Keep all attachment bolts tight.
- *Important: Do Not leave clippings in the bags while the mower is stored. Damp grass clippings are a fire hazard if left in the bag.*

OPERATION INSTRUCTIONS

SIDE DISCHARGE OF THE CLIPPINGS:

In order to achieve optimum performance when side discharging the grass clippings, please read and follow the tips listed below. Additional information can be found in the Troubleshooting guide.



CAUTION To avoid personal injury, be sure that the deflector is properly installed on the discharge chute.

1. Set engine speed control to the wide open or full setting.
2. *Do not attempt to cut grass when it is wet.* Wet grass will clog the underside of the deck and discharge area.
3. If the grass is tall, place the mower deck cut height lever in the top or second notch. “Initially” overlap cutting swaths instead of a full swath with each pass. Some applications may require a second cutting.
4. *Keep the underside of the mower deck clean.* Frequent removal of dried grass and dirt will allow the clippings to discharge correctly. **Never, under any circumstances, should you place hands or feet under the mower deck or in the chute while blades or impeller are still turning.**
5. *Maintain sharp blade(s) throughout the cutting season.*

OPERATION INSTRUCTIONS

GRASS HEIGHT & CUTTING SUGGESTIONS:

Do not attempt to cut grass when it is wet.

If the grass is tall, place the mower deck cut height lever in the top or second notch. "Initially" overlap cutting swaths instead of a full swath with each pass. Some applications may require a second cutting.

Keep the underside of the mower deck clean.

Maintain sharp blades throughout the cutting season.

As a rule of thumb, never cut off more than 1/3 of the total grass blade length. Correct mowing height can reduce weeds and disease by 50% to 80%.

The following grass cut heights are based on adequate moisture conditions and normal thatch build-up in a healthy lawn. Some locations and applications may require slightly different cut heights. If in doubt, consult your local lawn professional for assistance.

<u>Grass Types</u>	<u>Best Cut Heights</u>
Bermudagrass	1 - 2"
Bluegrass	2 - 3"
Buffalograss	1 ^{1/2} - 3"
Ryegrass	2 - 3"
Tall Fescue	3-3 ^{1/2} "
Zoysiagrass	1 - 3"

CARE AND MAINTENANCE

WARNING

Failure to observe the following instructions may result in personal injury.

*Before performing any maintenance, turn off engine,
allow to cool & remove key.
Use extreme care when working on machinery.
Do not wear watch or jewelry.
Do not wear loose fitting clothes, and observe all
common safety practices with tools.*

MAINTENANCE SCHEDULE

- Check deck drive belt.....after 20 hours break-in
- Check crankcase oil level.....before each use
- Clean grass & debris from muffler & manifold area.....before each use
- Check air intake screen.....after each use
- Clean grass under deck.....after each use
- Check tire pressure.....every 10 hours
- Inspect blades for sharpness.....every 10 hours
- Clean air filter element.....every 25 hours
- Grease all zerks.....every 50 hours
- Check all belts.....every 50 hours
- Change engine crankcase oil.....(5 hours break-in)
every 50 hours
- Change engine oil filter.....every 50 hours
- Replace air filter element.....annually or every 100 hours

CARE AND MAINTENANCE

CUTTER BLADE MAINTENANCE:



CAUTION Stop engine and remove ignition key for safety. Wear heavy, thick gloves when holding onto cutter blade, avoid the sharp edge of the blade.

Check sharpness of mower blades after every 10 hours of operation. Observe proper blade position prior to removal.

1. Safely raise front of mower.
2. Hold or block blade from turning.
3. Loosen blade bolt and remove blade.
4. When replacing blade, tighten blade bolt securely. Refer to diagram. Be sure blade is centered on pilot before tightening nut to 60 ft. lbs.

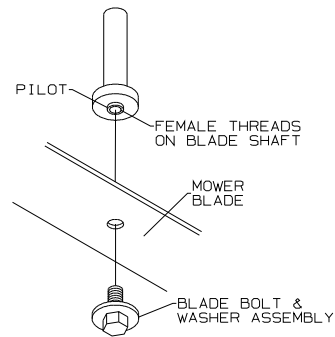

Blades should be discarded when worn excessively.

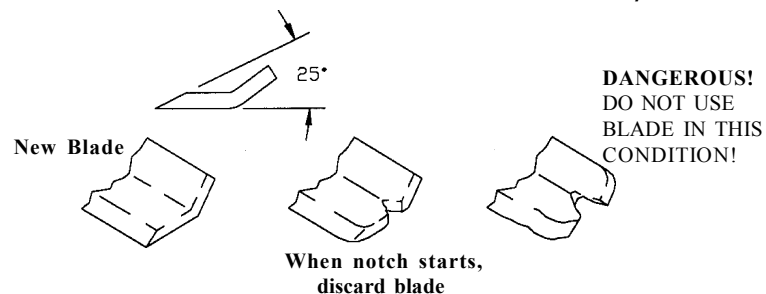

CARE AND MAINTENANCE

ENGINE:

For complete maintenance and operating information of the engine, please refer to the maintenance instructions furnished by the engine manufacturer included in your Zero Turn Radius mower information packet.

 **CAUTION** *Battery contains sulfuric acid electrolyte which is poisonous and corrosive.*

BATTERY:

This is a maintenance-free battery and the fluid level cannot be checked.

- Charge battery if required.

OFF SEASON BATTERY STORAGE:

- DO NOT remove battery from mower.
- Clean top of battery and terminals with baking soda and water.
- Identify each cable so they can be reconnected to the correct terminal.
- Disconnect cables from terminals. ALWAYS disconnect ground cable first and reconnect last.
- Charge battery.

Note: Your Dixon® mower comes equipped with a quick disconnect harness for the optional Dixon® Battery Manager. The Dixon® Battery Manager maintains the proper charge levels during periods of inactivity and may prevent premature battery failures. Contact your dealer for more information.

CARE AND MAINTENANCE

LUBRICATION:

CHASSIS:	(5) grease zerks
LOCATIONS:	(1) each front wheel caster (1) each front wheel hub (1) each mower deck hub
SERVICE INTERVALS:	Every 50 hours of operation or once per season.
RECOMMENDED GREASE:	Name brand wheel bearing or multi-purpose grease (3 pumps each)

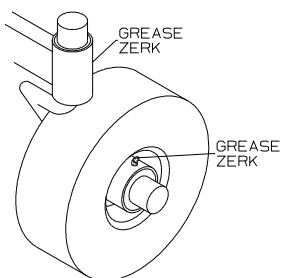

CARE AND MAINTENANCE

TIRES:

Correct tire pressure is essential for efficient operation of the mower. Check tire pressure periodically. Inflate tires to the pressure listed below.

Front tires	9 x 3.50 - 4	16-21 lbs.
Rear tires	16 x 6.50 - 8	8-14 lbs.

Lug nuts or lug bolts should be checked regularly for tightness.

BELTS:

Check belts every 50 hours. Replace any belts found to be in poor condition.

BELT TENSION:

Engine to Transmission Belt - P/N 7650
Manual adjustment.

Engine to Mower Deck Belt (manual clutch) - P/N 7725
No adjustment required.

CARE AND MAINTENANCE

ELECTRICAL SYSTEMS:

Keep all connections clean and tight.

CLEANING THE MOWER:

Wash mower periodically. Clean above and below deck.

High pressure washing and alkaline based soaps can cause damage to bearings and other parts of the mower. After washing your mower, start the engine and engage the mower deck for a few minutes to disperse any water that may have accumulated in bearings, pulleys or fans.

Note: Allow mower to cool before washing. If bearings are hot, they will draw moisture inside as they dry and cause corrosion.

SERIAL NUMBERS:

The serial number is located on frame at rear of engine.

WARRANTY:

Refer to warranty information (page 16).

PARTS/SERVICE:

See your Dixon® dealer for replacement parts, warranty or service.

CARE AND MAINTENANCE



CAUTION HOT oil may cause burns. Allow engine to cool before draining oil.

CHANGING THE ENGINE OIL:

1. The oil drain valve is located on the lower left side of the engine crankcase.
2. Place a suitable container under the drain valve.
3. To drain, remove plug from 90 degree fitting.
4. After engine is drained, replace drain plug.

NOTE: Refer to engine manufacturer's recommendations for frequency of oil changes.

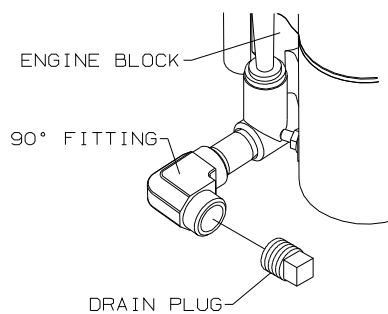

CARE AND MAINTENANCE



CAUTION HOT oil may cause burns. Allow engine to cool before draining oil.

OIL FILL:

1. Clean any spilled oil from engine and chassis.
2. Refill engine with type, and quantity of oil recommended by the engine manufacturer in engine literature.

NOTE: Engine oil changes on the ZEETER™ mower will require replacement of the oil filter. These filters may be available from your local Dixon® Dealer.

Protect your environment. Please dispose of used oils at proper collection centers.

CARE AND MAINTENANCE

MOWER DECK LEVELING PROCEDURE:

1. Place mower on a smooth, level surface and check tire pressures to insure correct stance. Tires should be inflated as follows.

Front: 16 - 21 lbs

Rear: 8 - 14 lbs

2. Turn blade so tips align with the deck in a side to side manner.
3. Measure from the floor surface up to the bottom of the blade tip on the discharge side of the mower. Retain this measurement. Move to the opposite side and check to see if that measurement is the same. If adjustment is required, turn nut on one or both of the rear L-rods until both measurements are equal.
4. Turn blade so tips align with the deck in a front to rear manner.
5. Measure from the floor surface up to the bottom of the blade tip at both the front and rear of the blade. Rear blade tip should be 1/8" to 1/4" higher than the front blade tip. If adjustment is necessary, turn nut on front L-rod.

(See Illustration A, page 41)

NOTE: This will place the mower deck in a base measurement position. Additional adjustment may be required to achieve desired cut for the type of grass or conditions involved.

CARE AND MAINTENANCE

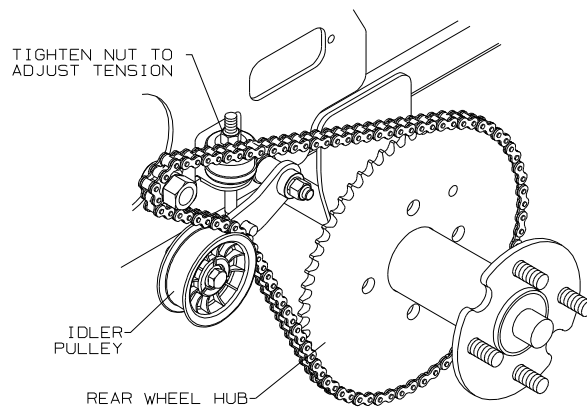
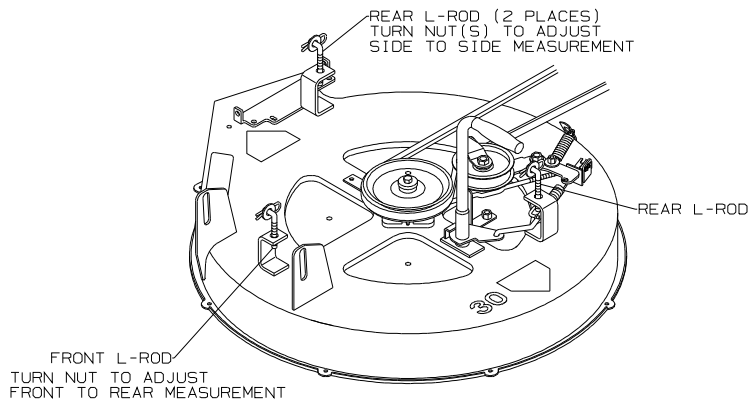

Illustration B

CARE AND MAINTENANCE

REAR CHAIN ADJUSTMENT:



Stop engine, remove key and set parking brake before attempting to adjust the rear chain.

Proper tension for the rear chains is accomplished through the use of an adjuster located at mid-point of each rear chain.

To adjust, tighten the nut on top of the rubber spring until the chain has approximately 1/4" movement up and down when measured at mid-point. Refer to Illustration B, page 41.

NOTE: Adjust rear drive chains after first 10 hours of use and every 40 hours thereafter.

NOTE: DO NOT OVERTIGHTEN CHAIN!

Maintenance:

Periodically remove any build-up of grass, mud or other debris from both the spring loaded roller and the upper guide rod. The use of a high quality chain lubricant is recommended.

CARE AND MAINTENANCE

DECK REMOVAL:

1. Place cut height lever in lowest cut position.
2. Loosen belt keepers.
3. Remove deck drive belt from engine pulley.
4. Using a slight upward twisting motion, remove link from engagement handle.
5. Turn handle fully to the left until handle clears stop on mower deck pan. Lift handle then remove handle down through hole in lower fender.
6. Remove hair pin cotter and washer from one end of deck support cross shaft. Note location of remaining shim washers used between chassis and mower deck pan arms. Slide shaft from chassis and mower deck.
7. Remove hair pin cotter and washer from each deck adjustment rod. Carefully push each link to disengage from deck lift arms. At this point, deck will drop down.
8. Carefully raise and support front of chassis. Slide mower deck to either side for removal. (Reverse procedure to reinsert deck assembly.)

CARE AND MAINTENANCE

DRIVE SYSTEM ADJUSTMENTS:

Due to both the complex nature of the transmission and the number of special tools required for service, adjustments should be entrusted to your dealer.

There are a number of simple owner service items which greatly influence the performance of the drive system.

1. Front and rear tires must be inflated to proper specifications.
2. Rear drive chain tension.
3. Tightness of all controls and linkages pertaining to the drive levers.
4. Lubrication of both primary and final drive chains. The use of a high quality chain lubricant is highly recommended.

STANDARD SERVICE PARTS LIST

BLADES

*Hi-Lift - P/N 13928
Standard Lift - P/N 13927
Gator - P/N 13929

*Factory installed

BELTS

Engine to Mower Deck - P/N 7725
Engine to Transmission - P/N 7650

ENGINE AIR AND OIL FILTERS

Refer to Engine Operator's Manual for correct service intervals for engine oil changes and air filter maintenance.

Protect your engine investment, use only original equipment filters. Refer to the Engine Operator's Manual or ask your dealer for correct replacement parts.

TROUBLESHOOTING

1. ENGINE WON'T TURN OVER

Mower blades engaged- ----- disengage blades
Parking brake not on- ----- engage parking brake
Circuit breaker trips- ----- reset breaker
Dead battery- ----- charge or replace
Solenoid- ----- consult dealer
Ignition switch- ----- consult dealer
Starter- ----- consult dealer

2. ENGINE WILL TURN OVER BUT WON'T START

No fuel- ----- refuel and/or clean or replace fuel filters

3. HARD TO START ENGINE

Fuel line clogged- ----- clean fuel line and check fuel filter
Faulty fuel pump- ----- consult dealer

4. ENGINE STARTS BUT CUTS OUT

Water in fuel- ----- drain old fuel-replace with new fuel
Clogged fuel line- ----- check fuel filter
Fuel tank vent plugged- ----- clean fuel vent
Faulty fuel pump- ----- consult dealer

5. ENGINE OVERHEATED

Air intake screen or fins clogged- ----- clean intake screen and fins
Oil level too low or too high- ----- adjust oil level
Running engine too slow - ----- run engine faster

TROUBLESHOOTING

6. ENGINE RUNS BUT MOWER WON'T MOVE FORWARD

Drive belt broken or slipping- ----- replace drive belt
Damaged transmission- ----- -consult dealer

7. MOWER LOSES POWER OR TRANSMISSION OVERHEATS

Engine air filter- ----- clean or replace
Transmission damage- ----- -consult dealer

8. ENGINE STALLS WHEN BLADES ARE ENGAGED

Operator not on seat- ----- -sit on seat
Faulty interlock system- ----- consult dealer
Faulty blade spindle bearing- ----- consult dealer
Deck drive belt not properly routed- ----- reroute
Blades blocked by foreign material - ----- clean under deck

9. DRIVE SYSTEM

Mower pulls to side- ----- -check tire inflation/adjust control linkage
Mower creeps in neutral- ----- adjust control linkage
Low on power- ----- -check belt tension

10. CUT QUALITY

Cut uneven left to right- ----- -check tire inflation/level deck
Ends of grass blades are ragged- ----- sharpen blades
Poor dispersal of grass- ----- clean deck/check for loose belt
Skips in spots- ----- -check for loose belt/slow ground speed

NOTES

NOTES

NOTES



OWNER'S INFORMATION

Date of Purchase _____

Mower Model Number _____

Mower Serial Number _____

Purchased From _____

Name

Address

DATE OIL CHANGED

DATE ENGINE TUNED

_____	_____
_____	_____
_____	_____
_____	_____
_____	_____
_____	_____
_____	_____
_____	_____
_____	_____
_____	_____

Dixon Industries, Inc.~P.O. Box 1569~Coffeyville, Ks~620-251-2000~Fax 620-251-4117



Dixon® and ZTR® are registered trademarks of
Dixon Industries, Inc.



WARNING: The engine exhaust from this product contains
chemicals known to the State of California to cause
cancer, birth defects or other reproductive harm.

DIXON INDUSTRIES, INC.
P.O. Box 1569
Coffeyville, Ks 67337-0945
620-251-2000

ZEETER™
Part No. 14295-1005

Free Manuals Download Website

<http://myh66.com>

<http://usermanuals.us>

<http://www.somanuals.com>

<http://www.4manuals.cc>

<http://www.manual-lib.com>

<http://www.404manual.com>

<http://www.luxmanual.com>

<http://aubethermostatmanual.com>

Golf course search by state

<http://golfingnear.com>

Email search by domain

<http://emailbydomain.com>

Auto manuals search

<http://auto.somanuals.com>

TV manuals search

<http://tv.somanuals.com>