

DYNE X TM ●●●

19" LCD TV/DVD Combo

DX-LTDVD19-09

USER GUIDE

Dynex DX-LTDVD19-09

19" LCD TV/DVD Combo

Contents

Child Safety	4
Important safety instructions	5
TV/DVD combo components	6
Front panel and top buttons	6
Right side	6
Back	7
Remote control	7
Setting up your TV/DVD combo	9
Installing remote control batteries	9
Using the remote control	9
Connecting an antenna or cable TV (no box)	9
Connecting a cable TV box with a coaxial cable	9
Connecting a cable TV box with a standard AV cable	10
Connecting a VCR with a standard AV cable	10
Connecting a VCR with an S-Video cable	11
Connecting a component video device	11
Connecting an HDMI device	11
Connecting a camcorder or video game	12
Connecting a computer	12
Using the TV	12
Turning on your TV/DVD combo	12
Selecting the TV signal source	12
Setting up the channel list	12
Selecting the video input source	13
Adjusting the volume	13
Changing TV channels	13
Displaying TV channel information	13
Adjusting the picture	13
Adjusting the computer image	14
Adjusting PC picture settings	14
Selecting the picture mode	14
Adjusting the audio	14
Select the audio mode	14
Selecting mono, stereo, or SAP	15
Setting the sleep timer	15
Selecting the TV aspect ratio	15
Adding a channel to the favorite list	15
Deleting channels from the channel list	15
Adding a label to a channel	15
Using closed captions	16
Changing digital closed caption styles	16
Setting the time	16
Blocking channels	17
Setting parental controls	17
Changing the password	19

Resetting all locks.....	19
Adjusting other functions.....	19
Using the DVD player.....	20
Playable discs.....	20
Playing a disc.....	20
Controlling disc playback.....	20
Playing a JPEG disc.....	20
Selecting a subtitle language.....	20
Repeating a section of a disc.....	21
Creating a playback loop.....	21
Selecting a viewing angle.....	21
Using a DVD main menu.....	21
Using a DVD title menu.....	21
Displaying disc information.....	21
Using program play.....	21
Searching for a scene.....	21
Playing a DVD in slow motion.....	21
Selecting the audio mode.....	21
Using the DVD setup menus.....	21
Maintaining.....	22
Cleaning the cabinet.....	22
Handling discs.....	23
Cleaning discs.....	23
Troubleshooting.....	23
Specifications.....	24
Legal notices.....	24
One-Year Limited Warranty.....	25

Child Safety

It makes a difference how and where you use your flat panel display

As you enjoy your new product, keep these safety tips in mind

The issue

The home theater entertainment experience is a growing trend, and larger TVs are popular purchases. However, TVs are not always supported on the proper stands or installed according to the manufacturer's recommendations. We and the consumer electronics industry are committed to making home entertainment enjoyable and safe.

TVs that are inappropriately placed on dressers, bookcases, shelves, desks, speakers, chests, or carts may fall over and cause injury.

Tune into safety

- One size of TV stand does **not** fit all. Use only a TV stand rated for the weight of your TV.
- Carefully read and understand all enclosed instructions for proper use of this product.
- Don't let children climb on or play with entertainment system furniture and TVs.
- Don't place TVs on furniture that can easily be used as steps, such as a chest of drawers.
- Remember that children can become excited while watching a program, especially on a "larger-than-life" TV. Make sure that you place or install the TV where it cannot be pushed, pulled over, or knocked down.
- Make sure that you route all cords and cables so that they cannot be pulled or grabbed by curious children.





Wall mounting

If you decide to wall mount your TV, always:

- One size of wall mount does **not** fit all. Use only a wall mount rated for the weight of your TV and that has been recommended by this TV manufacturer, listed in this manual, or otherwise listed by an independent laboratory (such as UL, CSA, or ETL) as suitable for your TV.
- Follow all instructions supplied by the TV and wall mount manufacturers.
- If you have any doubts about your ability to safely wall mount your TV, get help from a professional installer.
- Make sure that the wall where you are mounting the TV is appropriate. Some wall mounts are not designed to be mounted to walls backed with steel studs or cinder blocks. If you are unsure, ask a professional installer.
- TVs can be heavy. At least two people are required for safe wall mount installation.



	CAUTION RISK OF ELECTRIC SHOCK DO NOT OPEN	
CAUTION:	TO REDUCE THE RISK OF ELECTRIC SHOCK, DO NOT REMOVE COVER (OR BACK). NO USER SERVICEABLE PARTS INSIDE. REFER SERVICING TO QUALIFIED SERVICE PERSONNEL.	

Warning: To prevent fire or shock hazard, do not expose this appliance to rain or moisture.

Caution: To prevent electric shock do not use this polarized plug with an extension cord, receptacle or other outlet unless the blades can be fully inserted to prevent blade exposure.

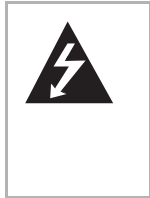

The lightning flash with arrowhead symbol, within an equilateral triangle is intended to alert the user to the presence of uninsulated dangerous voltage within the product's enclosure that may be of sufficient magnitude to constitute a risk of electric shock.



The exclamation point within an equilateral triangle is intended to alert the user to the presence of important operating and maintenance (servicing) instructions in the literature accompanying the appliance.

Caution: These servicing instructions are for use by qualified service personnel only. To reduce the risk of electric shock, do not perform any servicing other than that contained in the operating instructions unless you are qualified to do so.

Caution: Use of any controls, adjustments, or procedures other than those specified herein may result in hazardous radiation exposure.

Important safety instructions

- 1 Read these instructions.
- 2 Keep these instructions.
- 3 Heed all warnings.
- 4 Follow all instructions.
- 5 Do not use this apparatus near water.
- 6 Clean only with dry cloth.
- 7 Do not block any ventilation openings. Install in accordance with the manufacturer's instructions.
- 8 Do not install near any heat sources such as radiators, heat registers, stoves, or other apparatus (including amplifiers) that produce heat.
- 9 Do not defeat the safety purpose of the polarized or grounding-type plug. A polarized plug has two blades with one wider than the other. A grounding type plug has two blades and a third grounding prong. The wide blade or the third prong are provided for your safety. If the provided plug does not fit into your outlet, consult an electrician for replacement of the obsolete outlet.
- 10 Protect the power cord from being walked on or pinched particularly at plugs, convenience receptacles, and the point where they exit from the apparatus.
- 11 Only use attachments/accessories specified by the manufacturer.
- 12 Use only with cart, stand, tripod, bracket, or table specified by the manufacturer, or sold with the apparatus. When a cart is used, use caution when moving the cart/apparatus combination to avoid injury from tip-over.



S3126A

- 13 Unplug this apparatus during lightning storms or when unused for long periods of time.
- 14 Refer all servicing to qualified service personnel. Servicing is required when the apparatus has been damaged in any way, such as power-supply cord or plug is damaged, liquid has been spilled or objects have fallen into the apparatus, the apparatus has been exposed to rain or moisture, does not operate normally, or has been dropped.

Laser safety: Your TV/DVD combo uses a laser system. Only a qualified service person should remove the cover or attempt to service your TV/DVD combo because of possible eye injury.



Warning: Visible laser radiation is present when open and interlocks defeated. **Do not stare into beam.** The laser is located inside, near the deck mechanism.

Condensation

Moisture will form in the operating section of the player if the player is brought from cool surroundings into a warm room or if the temperature of the room rises suddenly. When this happens, the DVD player's performance will be impaired. To prevent this, let the player stand in its new surroundings for about an hour before switching it on, or make sure that the room temperature rises gradually.

Condensation may also form during the summer if the player is exposed to the breeze from an air conditioner. In such cases, change the location of the player.

Handling the LCD panel

- Do not press hard or jolt the LCD panel. It may cause the LCD panel glass to break and injury may occur.
- If the LCD panel is broken, make absolutely sure that you do not touch the liquid in the panel. This may cause skin inflammation.
- If the liquid gets in your mouth, immediately gargle and consult with your doctor. Also, if the liquid gets in your eyes or touches your skin, consult with your doctor after rinsing for at least 15 minutes or longer in clean water.

Damage requiring service

Unplug this TV from the power outlet and refer servicing to qualified service personnel under the following conditions:

- When the power supply cord or plug is damaged or frayed.
- If liquid has been spilled or objects have fallen into your TV/DVD combo.
- If your TV/DVD combo has been exposed to rain or water.
- If your TV/DVD combo does not operate normally by following the operating instructions. Adjust only those controls that are covered by the operating instructions because incorrect adjustment of other controls may result in damage and will often require extensive work by a qualified technician to restore your TV/DVD combo to its normal operation.
- If your TV/DVD combo has been dropped or damaged in any way.
- When your TV/DVD combo exhibits a distinct change in performance.

Replacement parts

When replacement parts are required, make sure that the service technician uses replacement parts specified by the manufacturer that have the same characteristics as the original part. Unauthorized substitutions may result in fire, electric shock, personal injury, or other hazards.

TV/DVD combo components

Front panel and top buttons

Note: The buttons are on the top of your TV/DVD combo.

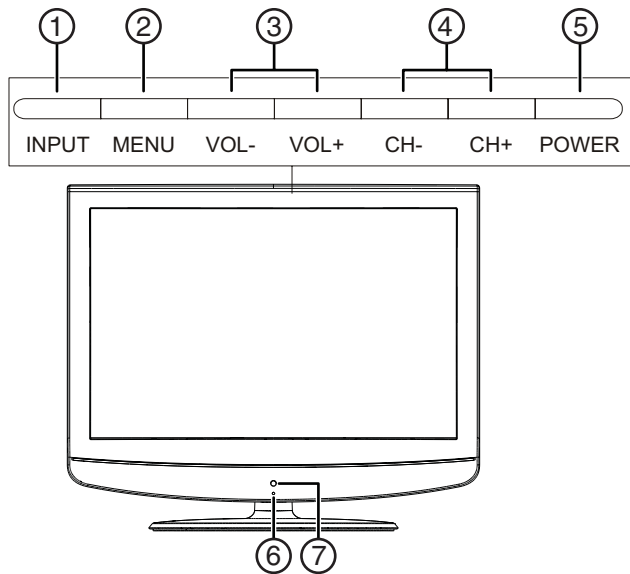

#	Component	Description
1	INPUT button	Press to select the video input source.
2	MENU button	Press to open the main menu.
3	VOL- / VOL+ buttons	Press to decrease or increase the volume.
4	CH- / CH+ buttons	In TV mode, press to go to the next lower or higher channel. In menu mode, press to move down or up in a menu.
5	POWER button	Press to turn on your TV/DVD combo or to put it in standby mode. When your TV/DVD combo is in standby mode, power is still flowing into your TV/DVD combo. To disconnect all power, unplug the power cord.
6	Power indicator	Lights red when your TV/DVD combo is in standby mode. Lights green when your TV/DVD combo is turned on.
7	Remote control sensor	Receives signals from the remote control. Do not block.

Right side

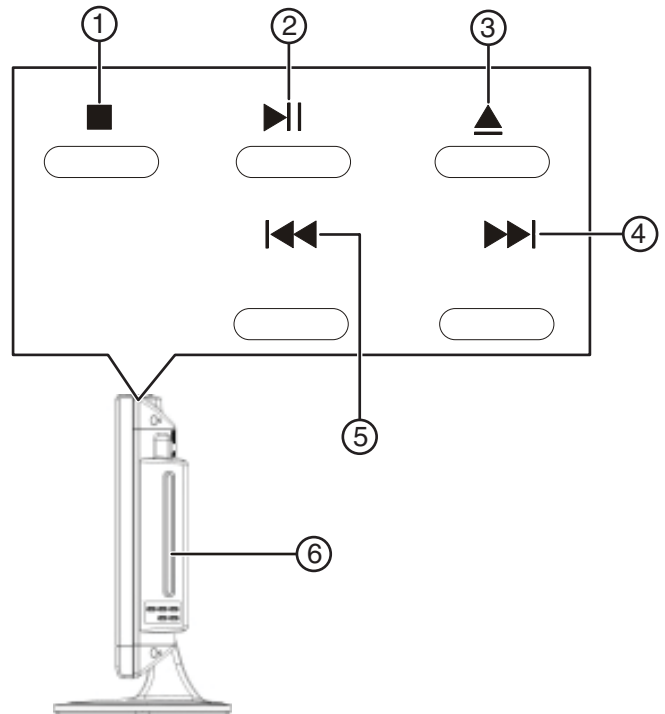

#	Component	Description
1	■ STOP button	Press to stop playback. If you press this button once then press ► , your TV/DVD combo begins playback where it stopped. If you press this button twice then press ► , your TV/DVD combo begins playback at the beginning of the disc.
2	► PLAY/PAUSE button	Press to pause playback. Press again to resume playback.
3	▲ OPEN/CLOSE button	Press to eject the disc from the disc slot.
4	►► NEXT button	Press to go to the next chapter or track.
5	◄◄ PREV button	Press to go to the beginning of the current chapter or track. If you press this button again, your TV/DVD combo goes to the previous chapter.
6	Disc slot	Insert a disc into this slot with the label facing forward.

Back

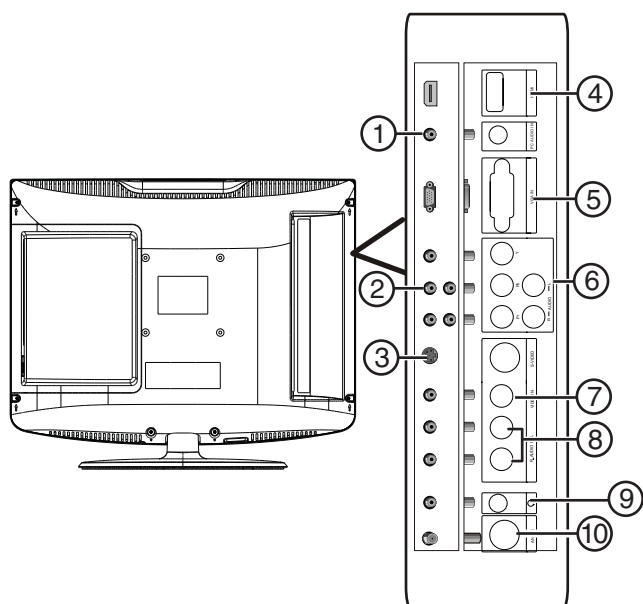

#	Jack	Description
1	PC AUDIO IN	Connect the audio for a computer to this jack. For more information, see "Connecting a computer" on page 12.
2	Pr, Pb, Y	Connect the video for a component video device to these jacks. For more information, see "Connecting a component video device" on page 11.
3	S-VIDEO	Connect an S-Video device to this jack. For more information, see "Connecting a VCR with an S-Video cable" on page 11.
4	HDMI	Connect an HDMI device to this jack. An HDMI cable carries both video and audio. You do not need to make an additional audio connection. For more information, see "Connecting an HDMI device" on page 11.
5	VGA IN	Connect the video for a computer to this jack. For more information, see "Connecting a computer" on page 12.
6	R and L AUDIO	Connect audio for a component video device to these jacks. For more information, see "Connecting a component video device" on page 11.
7	VIDEO IN	Connect a standard AV device to this jack. For more information, see "Connecting a VCR with a standard AV cable" on page 10.
8	R and L AUDIO	Connect the audio for an S-Video or standard AV device to these jacks. For more information, see "Connecting a VCR with an S-Video cable" on page 11 or "Connecting a VCR with a standard AV cable" on page 10.
9	🎧 (headphone)	Connect headphones to this jack.
10	ANT IN	Connect a TV antenna or cable TV to this jack.

Remote control

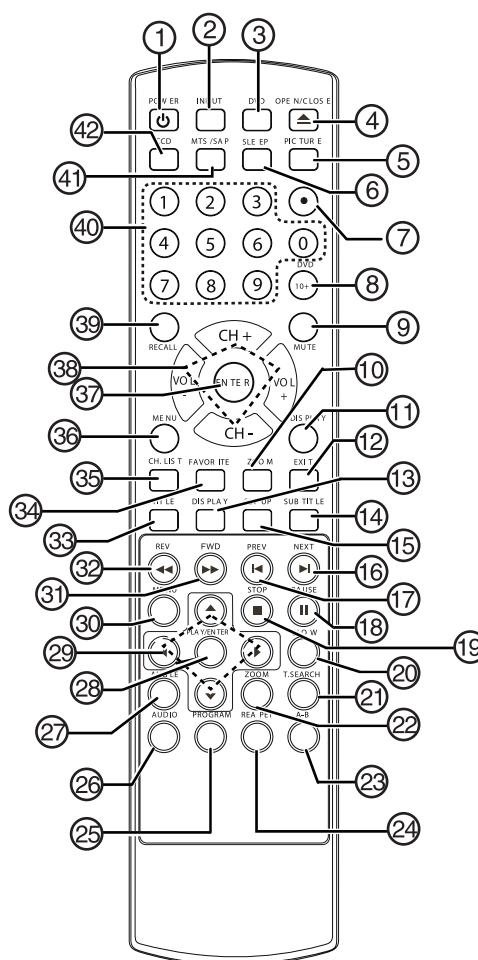

#	Button	Description
1	🔌 POWER	Press to turn on your TV/DVD combo or to put it in standby mode. When your TV/DVD combo is in standby mode, power is still flowing into your TV/DVD combo. To disconnect all power, unplug the power cord.
2	INPUT	Press to select the video input source. For more information, see "Selecting the video input source" on page 13.
3	DVD	Press to switch to DVD mode.
4	OPEN/CLOSE	Press to eject the disc from the disc slot.
5	PICTURE	Press to select the picture mode. For more information, see "Selecting the picture mode" on page 14.
6	SLEEP	Press to set the sleep timer. For more information, see "Setting the sleep timer" on page 15.
7	●	Press to select a digital sub-channel. For more information, see "Changing TV channels" on page 13.

#	Button	Description
8	DVD 10+	If a chapter or track number is over 10, press this button, then press the number for last digit in the chapter or track number.
9	MUTE	Press to turn off the sound. Press again to restore the sound.
10	ZOOM	In TV mode, press to select the aspect ratio. For more information, see "Selecting the TV aspect ratio" on page 15.
11	DISPLAY	Press to display channel information. For more information, see "Displaying TV channel information" on page 13.
12	EXIT	Press one or more times to close the menu.
13	DISPLAY	Press to display DVD program information.
14	SUBTITLE	Press to view DVD subtitles. For more informations, see "Selecting a subtitle language" on page 20.
15	SETUP	Press to open the setup menu.
16	▶ NEXT	Press to go to the next chapter or track on a disc.
17	◀ PREV	When playing a DVD, press to go to the previous chapter or track. When playing an MP3 file, press to go to the previous page.
18	⏸ PAUSE	Press to pause disc playback. Press PLAY/ENTER to resume normal playback.
19	■ STOP	Press to stop disc playback. If you press this button once then press PLAY/ENTER , the disc starts playing where it stopped. If you press this button twice then press PLAY/ENTER , the disc starts playing at the beginning.
20	SLOW	Press to play a DVD slowly forward. Each time you press this button the slow-forward speed changes. Press PLAY/ENTER to resume normal playback.
21	T.SEARCH	Press to search for a scene on a DVD. For more information, see "Searching for a scene" on page 21.
22	ZOOM	Press to enlarge the image from 2x, to 3x, to 4x.
23	A-B	Press to create a playback loop. For more information, see "Creating a playback loop" on page 21.
24	REPEAT	Press to repeat the current title, chapter, or track. For more information, see "Repeating a section of a disc" on page 21.
25	PROGRAM	Press to start program playback. For more information, see "Using program play" on page 21.
26	AUDIO	Press to select the audio mode. For more information, see "Select the audio mode" on page 14 (for TV mode) or "Selecting the audio mode" on page 21 (for DVD mode).

#	Button	Description
27	ANGLE	Press to select a viewing angle if the DVD was recorded with multiple viewing angles. For more information, see "Selecting a viewing angle" on page 21.
28	PLAY/ENTER	In DVD playback mode, press to start playback. In DVD menu mode, press to confirm selections.
29	▲ ▼ ◀ ▶	Press to make selections and adjust options in DVD menus.
30	MENU	Press to open the DVD main menu, if the DVD has one.
31	▶▶ FWD	Press to fast forward on a disc.
32	◀◀ REV	Press to fast reverse on a disc.
33	TITLE	Press to open the DVD title menu, if the DVD has one.
34	FAVORITE	Press to go to a favorite channel. For more information, see "Adding a channel to the favorite list" on page 15.
35	CH.LIST	Press to open the channel list. For more information about the channel list, see "Setting up the channel list" on page 12 and "Deleting channels from the channel list" on page 15.
36	MENU	Press to open the menu where you can adjust TV options.
37	ENTER	Press to confirm selections.
38	CH+ / CH- VOL+ / VOL-	In TV mode: Press the CH buttons to go to the higher or lower channel. Press the VOL buttons to increase or decrease the volume. In menu mode: Press the CH buttons to move up or down in a menu. Press the VOL buttons to adjust options.
39	RECALL	Press to go to the last viewed channel.
40	Numbers	In TV mode, press to enter channel numbers. In DVD mode, press to enter title, chapter, or track numbers. In Menu mode, press to enter the parental password.
41	MTS/SAP	Press to select the sound mode. For more information, see "Selecting mono, stereo, or SAP" or page 15.
42	CCD	Press to view closed captions. For more information, see "Using closed captions" on page 16.

Setting up your TV/DVD combo

Installing remote control batteries

To install remote control batteries:

- 1 Open the battery compartment cover.

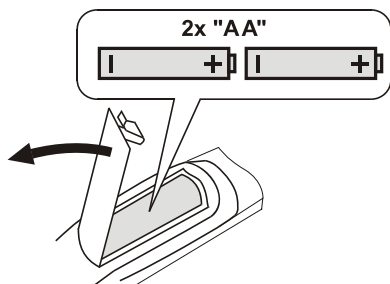

- 2 Insert two AA batteries into the battery compartment. Make sure that the + and – symbols on the batteries match the + and – symbols in the battery compartment.
- 3 Close the cover.

Using the remote control

To use the remote control:

- Point the remote control at the remote control sensor on the front of your TV. The remote control's range is 30° to each side of the remote sensor, 15° above and below the sensor, and within 26.25 ft. (8 m) of the sensor.

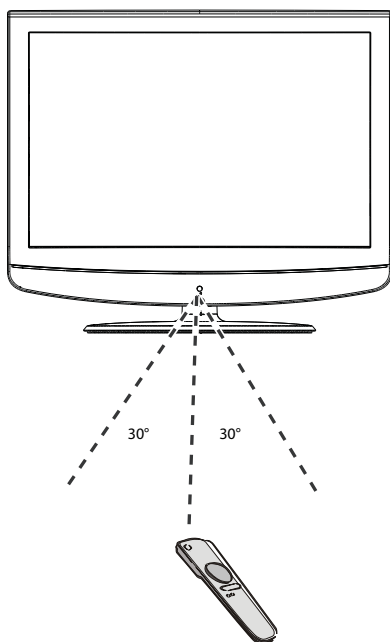

Caution: Do not expose the remote control to liquids, direct sunlight, or shock. Do not mix batteries of different types.

Notes:

Objects between the remote control and the remote control sensor may block the remote control signal.

Direct sunlight or other bright light shining on the remote control sensor may decrease the range of the remote control. In this case, change the angle of the lighting, move your TV/DVD combo, or operate the remote control closer to the remote control sensor.

Connecting an antenna or cable TV (no box)

To connect an antenna or cable TV (no box):

- 1 Connect one end of a coaxial cable (not included) to the **ANT IN** jack on the back of your TV/DVD combo, then connect the other end of the cable into the antenna or cable TV wall outlet.



- 2 To improve picture quality from an antenna in a poor signal area, install a signal amplifier.

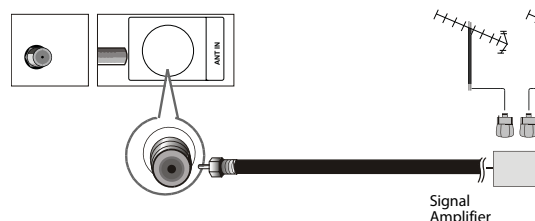

- 3 If you need to split the antenna signal to connect two TVs, install a two-way splitter.

Connecting a cable TV box with a coaxial cable

To connect a cable TV box with a coaxial cable:

- 1 Make sure that your TV/DVD combo and the cable box are turned off.
- 2 Connect a coaxial cable (not included) to the **ANT IN** jack on the back of your TV/DVD combo, then connect the other end of the cable to the coaxial out jack on the cable box.

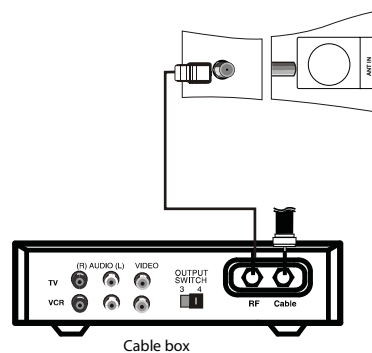

- 3 Set the channel switch on the cable TV box to 3 or 4.
- 4 Turn on your TV/DVD combo and the cable TV box, then set the TV channel to the same channel you selected in Step 3 (3 or 4).
- 5 Use the cable TV box controls or the cable TV box remote control to change channels.

Connecting a cable TV box with a standard AV cable

To connect a cable TV box with a standard AV cable:

- 1 Make sure that your TV/DVD combo and the cable TV box are turned off.
- 2 Connect a standard AV cable (not included) to the **VIDEO IN** (yellow) and adjacent **R** (red) and **L** (white) **AUDIO** jacks on the back of your TV/DVD combo, then connect the other end of the cable to the **VIDEO** and **AUDIO OUT** jacks on the cable TV box.

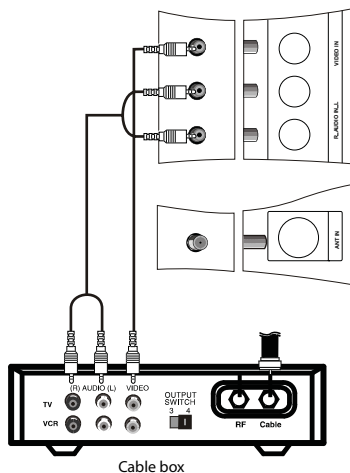

- 3 Turn on your TV/DVD combo and the cable TV box.
- 4 Press **INPUT**, press **CH+** or **CH-** to select **VIDEO**, then press **ENTER**.
- 5 Use the cable TV box controls or the cable TV box remote control to change channels.

Connecting a VCR with a standard AV cable

A standard AV connection provides good video and audio.

To connect a VCR with a standard AV cable:

- 1 Make sure that your TV/DVD combo and the VCR are turned off.
- 2 Connect a standard AV cable (not included) to the **VIDEO IN** (yellow) and adjacent **R** (red) and **L** (white) **AUDIO** jacks on the back of your TV/DVD combo, then connect the other end of the cable to the **VIDEO** and **AUDIO OUT** jacks on the VCR.

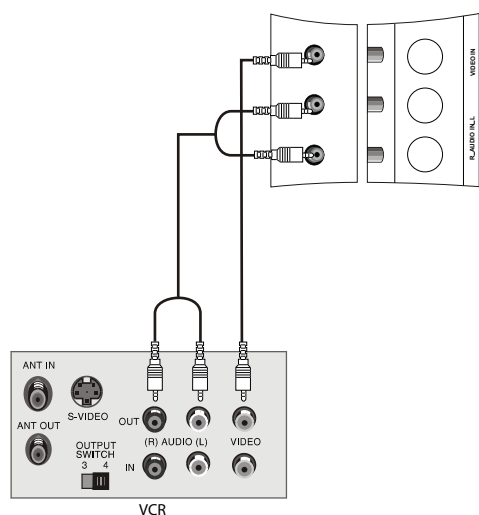

- 3 Turn on your TV/DVD combo and the VCR.
- 4 Press **INPUT**, press **CH+** or **CH-** to select **VIDEO**, then press **ENTER**.

Connecting a VCR with an S-Video cable

An S-Video connection provides better video than a standard AV connection.

To connect a VCR with an S-Video cable:

- 1 Make sure that your TV/DVD combo and the VCR are turned off.
- 2 Connect an S-Video cable (not included) to the **S-VIDEO** jack on the back of your TV/DVD combo, then connect the other end of the cable to the **S-VIDEO OUT** jack on the VCR.

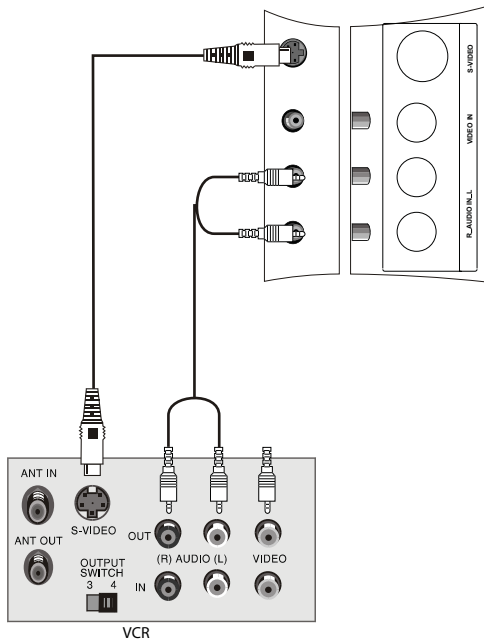

- 3 Connect a standard audio cable (not included) to the **R** and **L AUDIO** jacks to the left of the **VIDEO** jack on the back of your TV/DVD combo, then connect the other end of the cable to the **AUDIO OUT** jacks on the VCR.
- 4 Turn on your TV/DVD combo and the VCR.
- 5 Press **INPUT**, press **CH+** or **CH-** to select **S-VIDEO**, then press **ENTER**.

Connecting a component video device

A component video device provides better video than an S-Video connection.

To connect a component video device:

- 1 Make sure that your TV/DVD combo and the component video device are turned off.
- 2 Connect a component video cable (not included) to the **Pr**, **Pb**, and **Y** jacks on the back of your TV/DVD combo, then connect the other end of the cable to the corresponding **COMPONENT OUT** jacks on the component video device.

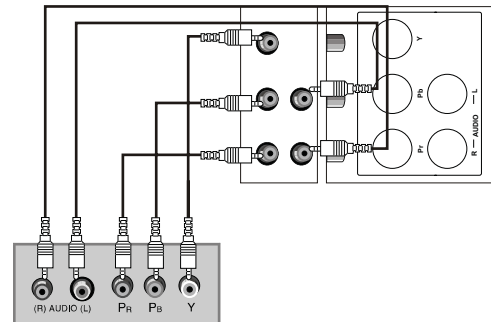

- 3 Connect a standard audio cable (not included) to the **R** and **L AUDIO** jacks below the **Pr**, **Pb**, and **Y** jacks on the back of your TV/DVD combo, then connect the other end of the cable to the **COMPONENT AUDIO OUT** jacks on the VCR.
- 4 Turn on your TV/DVD combo and the component video device.
- 5 Press **INPUT**, press **CH+** or **CH-** to select **COMPONENT**, then press **ENTER**.

Connecting an HDMI device

An HDMI connection provides the best video and audio. An HDMI cable carries both video and audio, so you do not need to make an audio connection.

To connect an HDMI device:

- 1 Make sure that your TV/DVD combo and the HDMI device are turned off.
- 2 Connect an HDMI cable (not included) to the **HDMI** jack on the back of your TV/DVD combo, then connect the other end of the cable to the **HDMI OUT** jack on the HDMI device.

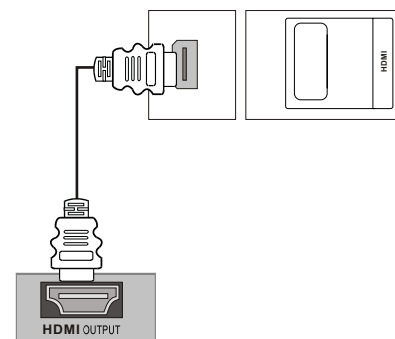

- 3 Press **INPUT**, press **CH+** or **CH-** to select **HDMI**, then press **ENTER**.

Connecting a camcorder or video game

To connect a camcorder or video game:

- 1 Follow the instructions in "Connecting a VCR with a standard AV cable" on page 10.

Connecting a computer

To connect a computer:

- 1 Make sure that the computer has a VGA jack. See the documentation that came with the computer.
- 2 Make sure that the computer and your TV/DVD combo are turned off.
- 3 Connect a VGA cable (not supplied) to the **VGA IN** jack on the back of your TV/DVD combo, then connect the other end of the cable to the **VGA** jack on the computer.

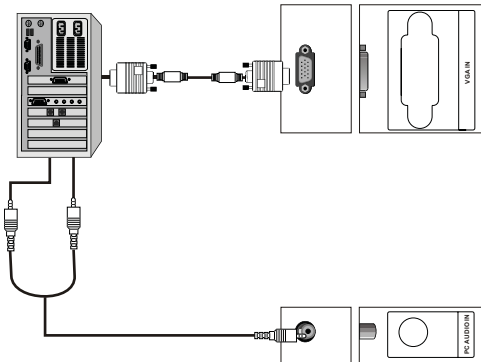

- 4 Connect an audio cable (not included) to the **PC AUDIO IN** jack on the back of your TV/DVD combo, then connect the other end of the cable to the **AUDIO OUT** jacks on the computer.
- 5 Turn on your TV/DVD combo first, then turn on the computer.
- 6 Press **INPUT**, press **CH+** or **CH-** to select **PC**, then press **ENTER**.
- 7 If you see video "noise" on the screen, you may need to adjust the brightness or contrast on your TV/DVD combo or the computer's video resolution or refresh rate on the computer. For information about adjusting the video on your TV/DVD combo, see "Adjusting the computer image" on page 14. For information about adjusting the video on the computer, see the documentation that came with the computer.

Supported video modes for a computer

Note: If the computer does not support one of the following video modes, you may need to replace or add a video card.

Your TV/DVD combo supports the following video modes:

Mode	Resolution	Line frequency (KHz)	Frame frequency (Hz)
VGA	640 × 480	31.5	60
SVGA	800 × 600	37.9	60
XGA	1024 × 768	48.4	60

Using the TV

All instructions use the remote control unless otherwise noted.

Turning on your TV/DVD combo

To turn on your TV/DVD combo:

- 1 Plug the power cord into a power outlet. Your TV/DVD combo enters standby mode and the power indicator lights red.
- 2 Press **POWER**. Your TV/DVD combo turns on and the power indicator lights green.
- 3 To put your TV/DVD combo into standby mode, press **POWER** again.

Caution: When your TV/DVD combo is in standby mode, power is still flowing into your TV/DVD combo. To disconnect all power, unplug the power cord.

Selecting the TV signal source

To select the TV signal source:

- 1 Press **MENU**, then press **CH+** or **CH-** repeatedly until the **Channel** menu appears.

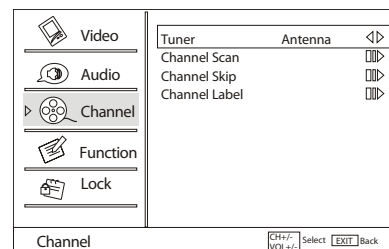

- 2 Press **VOL+** or **ENTER** to open the **Channel** menu.
- 3 Press **CH+** or **CH-** repeatedly to select **Tuner**, then press **VOL+** or **VOL-** to select **Antenna** or **Cable**.

Setting up the channel list

The first time you use your TV/DVD combo or if you move your TV/DVD combo to a different broadcast area, you need to scan for channels. Your TV/DVD combo scans for channels available in your area and stores the channel information in the channel list. When you press **CH+** or **CH-**, your TV/DVD combo goes to the next or previous channel in the channel list and skips any channel numbers that do not have a broadcast signal.

To set up the channel list:

- 1 Press **MENU**, then press **CH+** or **CH-** repeatedly until the **Channel** menu appears.

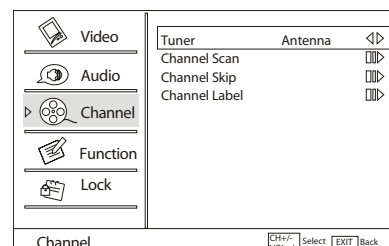

- 2 Press **VOL+** or **ENTER** to open the **Channel** menu.

- 3 Press **CH+** or **CH-** repeatedly to select **Channel Scan**, then press **VOL+** or **ENTER** to start scanning for channels.

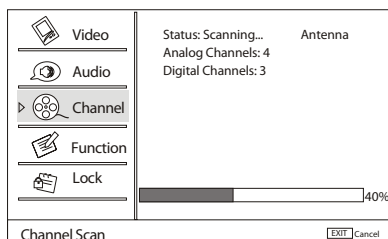

When the scan is complete, your TV/DVD combo displays the first channel in the channel list.

Selecting the video input source

To select the video input source:

- 1 Press **INPUT** to open the *Select Source* menu, then press **CH+** or **CH-** repeatedly to select the video input source. You can select **TV**, **VIDEO**, **S-VIDEO**, **Component**, **DVD**, **PC**, or **HDMI**.
- 2 Press **ENTER** to confirm.

Adjusting the volume

To adjust the volume:

- Press **VOL+** or **VOL-** to increase or decrease the volume.
- Press **MUTE** to turn off the sound. Press **MUTE** again or **VOL+** to restore the sound.

Changing TV channels

To change TV channels:

- To tune directly to a channel, press the number buttons for the channel number.
- To go to the last viewed channel, press **RECALL**.
- To scroll through the channels in the channel list, press **CH+** or **CH-**. For information about setting up the channel list, see "Setting up the channel list" on page 12.
- To select a channel from the channel list, press **CH.LIST**. The channel list opens. Press **CH+** or **CH-** to select a channel, then press **ENTER**. If the channel list has more channels than can be displayed on the screen, press **VOL+** or **VOL-** to go to the previous or next page in the list. For information about setting up the channel list, see "Setting up the channel list" on page 12.
- To select a digital sub-channel, press the number buttons for the main channel, press **●**, then press the number button for the sub-channel. For example, to select digital channel 11.1, press **11**, **●**, then press **1**.
- To select a channel in the favorite list, press **FAVORITE**. The favorite list opens. Press **CH+** or **CH-** to select the channel you want, then press **ENTER**. For information about adding a channel to the favorite list, see "Adding a channel to the favorite list" on page 15.

Displaying TV channel information

To display TV channel information:

- Press **DISPLAY**. Your TV/DVD combo displays information about the current channel.
- Press **DISPLAY** again to close the channel information display. You can also wait a few seconds for the display to close automatically.

Adjusting the picture

To adjust the picture:

- 1 Press **MENU**, then press **CH+** or **CH-** repeatedly until the *Video* menu appears.

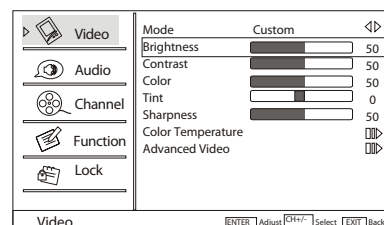

- 2 Press **VOL+** or **ENTER** to open the *Video* menu.
 - 3 Press **CH+** or **CH-** repeatedly to select **Mode**, then press **VOL+** or **VOL-** to select **Mild**, **Standard**, **Vivid**, or **Custom**.
 - 4 Press **CH+** or **CH-** to select the option you want to adjust, then press **VOL+** or **ENTER** to confirm. You can select:
 - **Brightness**—Adjusts the brightness.
 - **Contrast**—Adjusts the contrast.
 - **Color**—Adjusts the color saturation.
 - **Tint**—Adjust the picture tone.
 - **Sharpness**—Adjusts the detail enhancement. Increasing the sharpness makes the picture cleaner and clearer. Decreasing the sharpness makes the picture smoother.
 - **Color Temperature**—Adjusts the color temperature. You can select **Normal** (give the white colors a neutral tint), **Warm** (gives the white colors a red tint), **Cool** (gives the white colors a blue tint), or **Custom**.
 - **Advanced Video**—Adjusts advanced video options. For more information, see "Adjusting advanced video options" on page 13.
 - 5 Press **VOL+** or **VOL-** to adjust the option.
 - 6 Repeat Steps 4 and 5 to adjust additional options.
- Note: You can only adjust **Brightness**, **Contrast**, **Color**, **Tint**, **Sharpness**, and **Color Temperature** if you selected **Custom**.*

Adjusting advanced video options

To adjust advanced video options:

- 1 Press **CH+** or **CH-** to select **Advanced Video**, then press **VOL+** or **ENTER** to confirm.
- 2 Press **CH+** or **CH-** to select the option you want to adjust, then press **VOL+** or **ENTER** to select. You can select:
 - **DNR**—Digital Noise Reduction. Reduces the appearance of digitizing errors caused by compression. You can select **Off**, **Weak**, **Medium**, **Strong**, or **Auto**.
 - **Black Level Extender**—Adjusts the black areas of the picture. You can select **On** or **Off**.
 - **White Peak Limiter**—Adjust the white areas of the picture. You can select **On** or **Off**.
 - **CTI**—Color Transient Intensity. Adjusts color errors in the picture. You can select **Off**, **Weak**, **Medium**, or **Strong**.
 - **Flesh Tone**—Adjusts the flesh colors in the picture. You can select **On** or **Off**.
 - **Adaptive Luma Control**—Adjusts the picture luminance. You can select **On** or **Off**.

Adjusting the computer image

To adjust the computer image:

- 1 While in VGA mode, press **MENU**, then press **CH+** or **CH-** repeatedly until the *Video* menu appears.

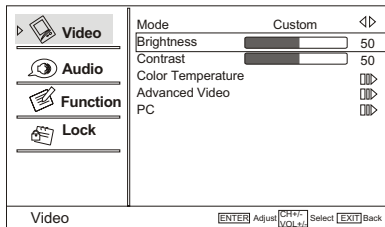

- 2 Press **VOL+** or **ENTER** to open the *Video* menu.
- 3 Press **CH+** or **CH-** to select an option. You can select:
 - **Brightness**—Adjusts the brightness.
 - **Contrast**—Adjusts the contrast.
 - **Color Temperature**—Adjusts the color temperature.
 - **Advanced Video**—Opens the Advanced Video menu where you can adjust **DNR**, **Black Level Extender**, **White Peak Limiter**, **CTI**, **Flesh Tone**, and **Adaptive Luma Control**.
 - **PC**—Opens a menu where you can adjust advanced video options. For more information, see "Adjusting PC picture settings" on page 14.
- 4 Press **VOL+** or **VOL-** to adjust the option.

Adjusting PC picture settings

When you are using a PC with your TV, a special PC option becomes available that lets you optimize your TV's picture settings for use with the PC.

To adjust PC picture settings:

- 1 While in VGA mode, press **MENU**, then press **CH+** or **CH-** repeatedly until the *Video* menu appears.

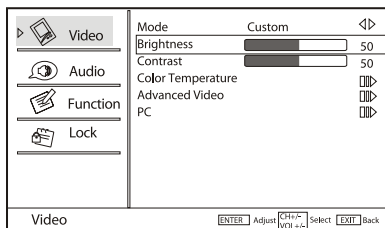

- 2 Press **VOL+** or **ENTER** to open the *Video* menu.
- 3 Press **CH+** or **CH-** to select **PC**, then press **ENTER** to confirm. The *PC Video* sub-menu opens.

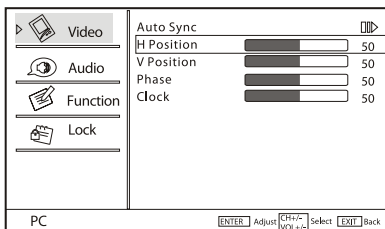

- 4 Press **CH+** or **CH-** to select an option, then press **ENTER** to confirm. You can select:
 - **Auto Sync**—Press **VOL+** to automatically adjust the settings for optimum PC viewing.
 - **H Position**—Adjusts the horizontal position of the picture.
 - **V Position**—Adjusts the vertical position of the picture.
 - **Phase**—Adjusts the phase setting of the picture.
 - **Clock**—Adjusts the clock setting of the picture.
- 5 Press **VOL+** or **VOL-** to adjust the setting.
- 6 Repeat Steps 4 and 5 to adjust the other settings.
- 7 Press **EXIT** to close the menu and return to normal viewing.

Selecting the picture mode

To select the picture mode:

- Press **PICTURE** repeatedly to select **Mild**, **Standard**, **Vivid**, or **Custom**.

Adjusting the audio

To adjust the audio:

- 1 Press **MENU**, then press **CH+** or **CH-** repeatedly until the *Audio* menu appears.

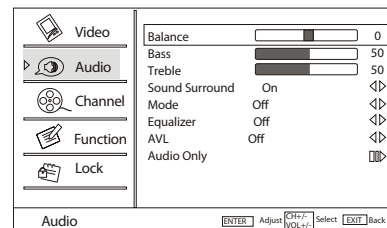

- 2 Press **VOL+** or **ENTER** to open the *Audio* menu.
- 3 Press **CH+** or **CH-** to select the option you want to adjust, then press **VOL+** or **ENTER** to confirm. You can select:
 - **Balance**—Adjusts the balance between the left and right audio channels.
 - **Bass**—Increases or decreases the level of low-pitched sounds.
 - **Treble**—Increase or decreases the level of high-pitched sounds.
 - **Sound Surround**—Turns simulated surround sound **On** or **Off**.
 - **Mode**—Selects the audio mode. You can select **Off**, **Concert**, **Living Room**, **Hall**, **Bathroom**, **Cave**, **Arena**, or **Church**.
 - **Equalizer**—Selects the equalizer mode. You can select **Off**, **Rock**, **Pop**, **Live**, **Dance**, **Techno**, **Classic**, or **Soft**.
 - **AVL**—Automatically adjusts the volume between different broadcasters, or example, adjusts the volume between a program and commercials. You can select **On** or **Off**.
 - **Audio Only**—Turns the video off. When you select this option, a message asks you to confirm your selection. Press **VOL+** or **VOL-** to select **OK**, then press **ENTER**. To see the video again, press **POWER**.
- 4 Press **VOL+** or **VOL-** to adjust the option.

Select the audio mode

To select the audio mode:

- Press **AUDIO** repeatedly to select **Off**, **Concert**, **Living Room**, **Hall**, **Bathroom**, **Cave**, **Arena**, or **Church**.

Selecting mono, stereo, or SAP

Note: This option only works for analog channels.

Your TV/DVD combo can receive stereo programs and secondary audio programs (SAP) if the broadcaster sends a stereo signal. If you select stereo or SAP and the program is broadcast in mono, your TV/DVD combo plays the audio in mono.

To select mono, stereo, or SAP:

- Press **MTS/SAP** repeatedly to select **Mono**, **Stereo**, or **SAP**.

Setting the sleep timer

You can select the amount of time you want your TV/DVD combo to wait before it automatically turns off.

To set the sleep timer:

- Press **SLEEP** repeatedly to select **Off**, **5 Min**, **10 Min**, **15 Min**, **30 Min**, **45 Min**, **60 Min**, **90 Min**, **120 Min**, **180 Min**, or **240 Min**.

Selecting the TV aspect ratio

To select the TV aspect ratio:

- Press **ZOOM** repeatedly to select **Full Screen**, **Normal**, **Wide**, **Zoom**, or **Cinema**.

Note: The aspect ratios you can select may vary depending on the video input mode.

Adding a channel to the favorite list

To add a channel to the favorite list:

- Press **CH.LIST**. The channel list opens.
- Press **CH+** or **CH-** to select the channel you want to add.
- Press **FAVORITE**, then press **ENTER** to add the channel to the list.
- To remove a channel from the favorite list, open the channel list, select the channel you want to remove, press **FAVORITE**, then press **ENTER**.

For information about tuning to a favorite channel, see "Changing TV channels" on page 13.

Deleting channels from the channel list

After you scan for channels to set up the channel list, you can delete channels from the list. When you press **CH+** or **CH-**, your TV/DVD combo skips the channel you deleted. You can still tune to the channel using the number buttons.

To delete channels from the channel list:

- Press **MENU**, then press **CH+** or **CH-** repeatedly until the **Channel** menu appears.

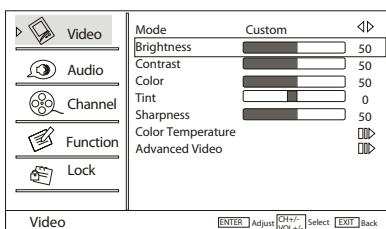

- Press **VOL+** or **ENTER** to open the **Channel** menu.

- Press **CH+** or **CH-** repeatedly to select **Channel Skip**, then press **VOL+** or **ENTER**.

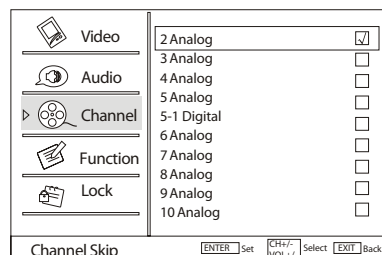

- Press **CH+** or **CH-** to select the channel you want to delete, then press **ENTER**. A check mark appears next to the channel.

Note: When you press **CH+** or **CH-**, your TV/DVD combo will skip the channel you deleted from the list. You can still tune to the channel using the number buttons.

Note: If you want to add a channel back to the list, repeat these steps. When you press **ENTER**, the check mark disappears and the channel is added back to the list.

Adding a label to a channel

You can add a label to a channel to make it easier to find.

To add a label to a channel:

- Press **MENU**, then press **CH+** or **CH-** repeatedly until the **Channel** menu appears.

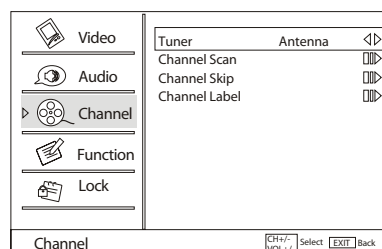

- Press **VOL+** or **ENTER** to open the **Channel** menu.
- Press **CH+** or **CH-** repeatedly to select **Channel Label**, then press **VOL+** or **ENTER**.

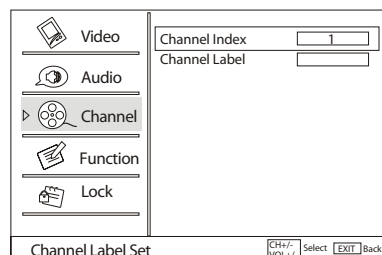

- Press **CH+** or **CH-** to select **Channel Index**, then press **INPUT** repeatedly to select a channel you want to label.
- Press **CH+** or **CH-** to select **Channel Label**, then press **INPUT** repeatedly to select the letter, number, or symbol you want. You can enter ten characters.
- Press **VOL+** to go to the next character.
- Repeat Step 5 and Step 6 to enter additional characters.
- When you finish the label, press **ENTER** to confirm. If you need to change a character you have already entered, press **VOL-** to go to that character.
- Repeat Step 4 through Step 8 to label additional channels.
- Press **EXIT** to close the menu and return to normal viewing.

Using closed captions

To use closed captions:

- 1 Press **MENU**, then press **CH+** or **CH-** repeatedly until the *Function* menu appears.

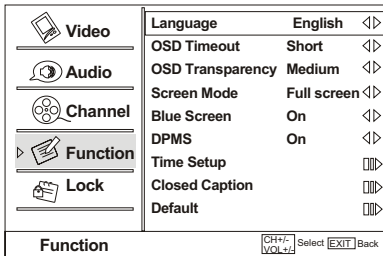

- 2 Press **VOL+** or **ENTER** to open the *Function* menu.
- 3 Press **CH+** or **CH-** repeatedly to select **Closed Caption**, then press **VOL+** or **ENTER**.

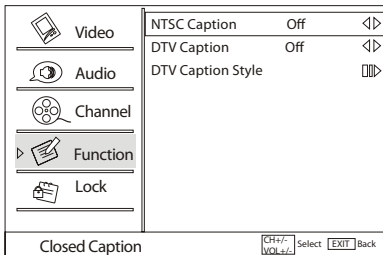

- 4 Press **CH+** or **CH-** to select:
 - **NTSC Caption**—Selects analog closed captions. Select **CC1** to see closed captions in the same language as the audio. Select **CC2** to see closed captions in a different language than the audio. **CC3** and **CC4** display information provided by the broadcaster. **TEXT1** through **TEXT4** display information provided by the broadcaster. The **TEXT** modes cover a large part of the screen.
 - **DTV Caption**—Selects digital closed captions. You can select **Service1** through **Service6**.

Note: The availability of closed captions and secondary languages depends on the broadcaster.
- 5 Press **VOL+** or **VOL-** to select the **NTSC Caption** or **DTV Caption** mode.

Changing digital closed caption styles

To change digital closed caption styles:

- 1 Press **MENU**, then press **CH+** or **CH-** repeatedly until the *Function* menu appears.

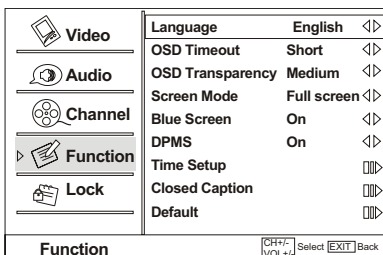

- 2 Press **VOL+** or **ENTER** to open the *Function* menu.

- 3 Press **CH+** or **CH-** repeatedly to select **Closed Caption**, then press **VOL+** or **ENTER**.

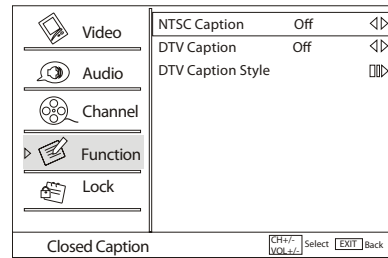

- 4 Press **CH+** or **CH-** to select **DTV Caption Style**, then press **VOL+** or **ENTER**.

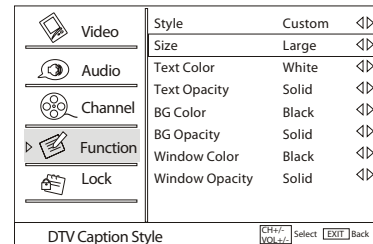

ABC

- 5 Press **CH+** or **CH-** to select an option, then press **VOL+** or **VOL-** to adjust the option. As you adjust an option, the small box to the right shows a preview of the adjustment. You can select:
 - **Size**—Selects the size of the caption display.
 - **Text Color**—Selects the text color or the opacity of the text box.
 - **Text Opacity**—Selects the opacity of the text color.
 - **BG Color**—Selects the background color.
 - **BG Opacity**—Selects the opacity of the background color.
 - **Window Color**—Selects the window color.
 - **Window Opacity**—Selects the window opacity.
- 6 Press **VOL+** or **VOL-** to adjust the option.

Setting the time

To set the time:

- 1 Press **MENU**, then press **CH+** or **CH-** repeatedly until the *Function* menu appears.

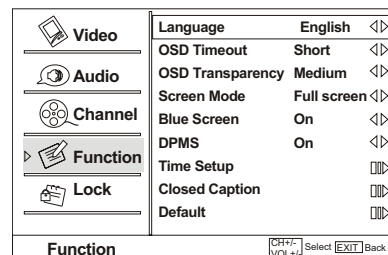

- 2 Press **VOL+** or **ENTER** to open the *Function* menu, then press **CH+** or **CH-** to select **Time Setup**.
- 3 Press **VOL+** or **VOL-** to select your time zone.

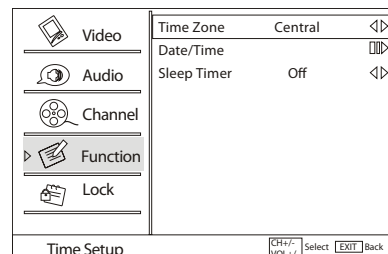

- 4 Press **CH+** or **CH-** to select **Date/Time**, then press **VOL+** or **ENTER**.

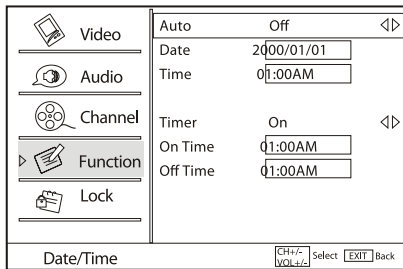

- 5 Press **CH+** or **CH-** to select the option you want to change. You can select:
- **Auto**—Sets the correct time for your area automatically. Select **On** or **Off**. This option only works with TV channels that transmit time information.
 - **Date**—Sets the correct date.
 - **Time**—Sets the correct time.
 - **Timer**—Turns the automatic timer **On** or **Off**.
 - **On Time**—Sets the time that the TV comes on automatically.
 - **Off Time**—Sets the time that the TV goes off automatically.
- 6 Press **VOL+** or **VOL-** to change the setting. For the **Date**, **Time**, **On Time**, and **Off Time** options, press **VOL+** or **VOL-** to select the position to change, then input the information with the number buttons.
- 7 Repeat Step 5 and Step 6 to adjust the other settings.
- Note: The Auto function is available only with digital channel with time information.*

Blocking channels

You can block channels you do not want to view.

To block channels:

- 1 Press **MENU**, then press **CH+** or **CH-** repeatedly until the **Lock-Enter Password** menu appears.

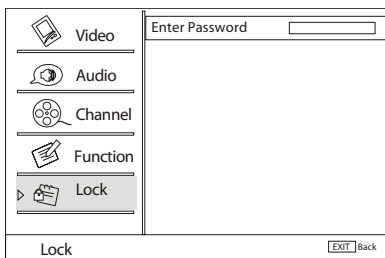

- 2 Press **VOL+** or **ENTER** to open the **Lock-Enter Password** menu, then press the number buttons to enter the password. The default password is **0000**. If you change the password, then forget it, enter **9443**.

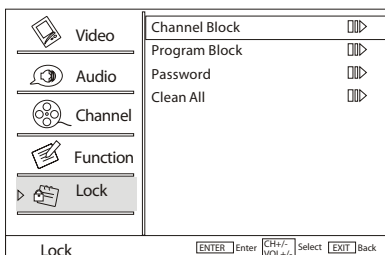

- 3 Press **CH+** or **CH-** to select **Channel Block**, then press **VOL+** or **ENTER**.

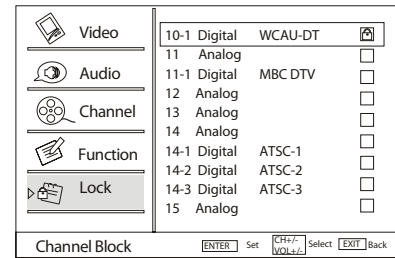

- 4 Press **CH+** or **CH-** to select the channel you want to block, then press **ENTER**. The channel is locked and a lock appears next to the channel.
- 5 Press **EXIT** repeatedly to close the menu.
- Note: To unblock a channel, repeat these steps.*

Setting parental controls

You can block TV programs and movies based on their ratings.

To set parental controls:

- 1 Press **MENU**, then press **CH+** or **CH-** repeatedly until the **Lock-Enter Password** menu appears.

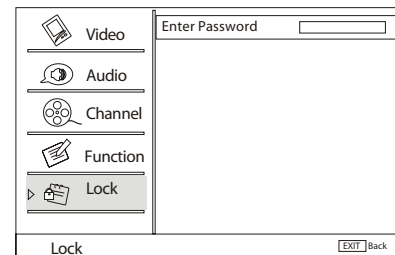

- 2 Press **VOL+** or **ENTER** to open the **Lock-Enter Password** menu, then press the number buttons to enter the password. The default password is **0000**. If you change the password, then forget it, enter **9443**.

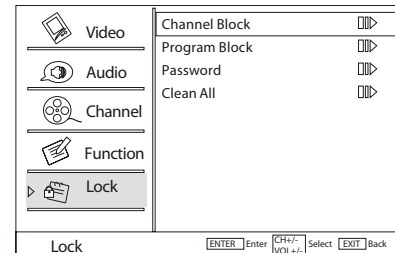

- 3 Press **CH+** or **CH-** to select **Program Block**, then press **VOL+** or **ENTER**.

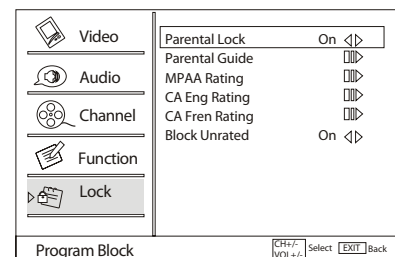

- 4 If the **Parental Lock** is set to **On**, press **VOL+** or **VOL-** to set the lock to **Off**.

- 5 Press **CH+** or **CH-** to select a parental option. You can select:
 - **Parental Guide**—Blocks U.S. TV programs based on ratings. For more information, see “U.S. TV program ratings” on page 18.
 - **MPAA Rating**—Blocks movies based on ratings. For more information, see “Movie ratings” on page 19.
 - **CA Eng Rating**—Blocks Canadian English TV programs. For more information, see “Canadian English TV program ratings” on page 18.
 - **CA Fren Rating**—Blocks Canadian French TV programs. For more information, see “Canadian French TV program ratings” on page 18.
 - **Block Unrated**—Turn **On** to block all unrated programs. Press **VOL+** or **VOL-** to change the setting, then press **ENTER** to confirm.
- 6 When the selected sub-menu opens, press **CH+**, **CH-**, **VOL+**, or **VOL-** to select an item to block, then press **ENTER** to confirm. A small lock icon appears in the box opposite the rating you blocked. All programs above that rating are blocked as well.
- 7 To unblock the item, press **ENTER** again.

U.S. TV program ratings

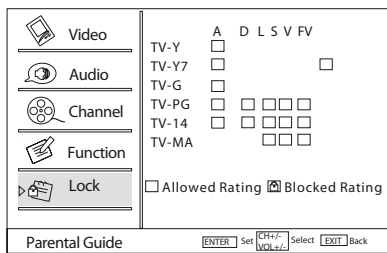

TV-Y	All children.
TV-Y7	Children 7 and over. May include comic violence.
TV-G	General audience. Contains little or no violence, strong language, or sexual dialog or situations.
TV-PG	Parental guidance suggested. May contain mild violence, sexual dialog or situations, and coarse language.
TV-14	Parents strongly cautioned. May contain sexual content, strong language, and intense violence.
TV-MA	Mature audiences only. May contain sexual violence, explicit sexual content, and profane language.

In addition to the primary ratings, some ratings let you block certain types of content.

A	Blocks all content-based ratings
D	Sexual dialog
L	Offensive language
S	Sexual situations
V	Violence
FV	Fantasy violence.

Canadian English TV program ratings

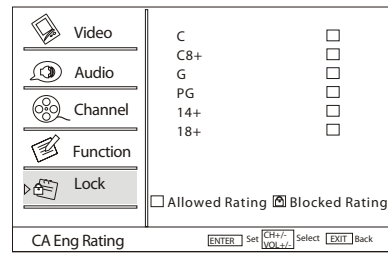

C	Suitable for all children. Contains no offensive language, nudity, or sexual content.
C8+	Suitable for children 8 and over. Contains no profanity, nudity, or sexual content.
G	General audiences.
PG	Parental guidance suggested. Some content may not be suitable for children.
14+	Parental guidance strongly suggested. Not suitable for children under 14.
18+	Adults only.

Canadian French TV program ratings

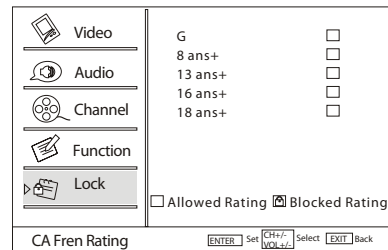

G	Suitable for all children.
8 ans+	Children 8 and older.
13 ans+	Children 13 and older.
16 ans+	Children 16 and older.
18 ans+	Adults only.

Movie ratings

Video	G	<input type="checkbox"/>
Audio	PG	<input type="checkbox"/>
Channel	PG-13	<input type="checkbox"/>
Function	R	<input type="checkbox"/>
Lock	NC-17	<input type="checkbox"/>
	X	<input type="checkbox"/>
MPAA Rating		<input type="checkbox"/> Allowed Rating <input checked="" type="checkbox"/> Blocked Rating
<input type="button" value="ENTER"/> Set <input type="button" value="CH+/VOL+"/> Select <input type="button" value="EXIT"/> Back		

G	General audiences.
PG	Parental guidance suggested. Some content may not be suitable for children.
PG-13	Parents strongly cautioned. Some content may not be suitable for children under 13.
R	Restricted. Some content may not be suitable for children under 17.
NC-17	Not suitable for children under 17.
X	Adults only.

Changing the password

To change the password:

- 1 Press **MENU**, then press **CH+** or **CH-** repeatedly until the *Lock-Enter Password* menu appears.

Video	Enter Password
Audio	
Channel	
Function	
Lock	
<input type="button" value="ENTER"/> Enter <input type="button" value="CH+/VOL+"/> Select <input type="button" value="EXIT"/> Back	

- 2 Press **VOL+** or **ENTER** to open the *Lock-Enter Password* menu, then press the number buttons to enter the password. The default password is **0000**. If you change the password, then forget it, enter **9443**.

Video	Channel Block	<input type="button" value="Left"/>	<input type="button" value="Right"/>
Audio	Program Block	<input type="button" value="Left"/>	<input type="button" value="Right"/>
Channel	Password	<input type="button" value="Left"/>	<input type="button" value="Right"/>
Function	Clean All	<input type="button" value="Left"/>	<input type="button" value="Right"/>
Lock			
<input type="button" value="ENTER"/> Enter <input type="button" value="CH+/VOL+"/> Select <input type="button" value="EXIT"/> Back			

- 3 Press **CH+** or **CH-** to select **Password**, then press **VOL+** or **ENTER**.
- 4 Press the number buttons to enter a new password in the **New Password** field, then enter the new password again in the **Confirm Password** field.

Resetting all locks

To reset all locks:

- 1 Press **MENU**, then press **CH+** or **CH-** repeatedly until the *Lock-Enter Password* menu appears.

Video	Enter Password
Audio	
Channel	
Function	
Lock	
<input type="button" value="EXIT"/> Back	

- 2 Press **VOL+** or **ENTER** to open the *Lock-Enter Password* menu, then press the number buttons to enter the password. The default password is **0000**. If you change the password, then forget it, enter **9443**.

Video	Channel Block	<input type="button" value="Left"/>	<input type="button" value="Right"/>
Audio	Program Block	<input type="button" value="Left"/>	<input type="button" value="Right"/>
Channel	Password	<input type="button" value="Left"/>	<input type="button" value="Right"/>
Function	Clean All	<input type="button" value="Left"/>	<input type="button" value="Right"/>
Lock			
<input type="button" value="ENTER"/> Enter <input type="button" value="CH+/VOL+"/> Select <input type="button" value="EXIT"/> Back			

- 3 Press **CH+** or **CH-** to select **Clean All**, then press **VOL+** or **ENTER**. A message asks you to confirm.
- 4 Press **VOL+** or **VOL-** to select **OK**, then press **ENTER**.

Adjusting other functions

You can adjust other functions from the *Function* menu.

To adjust other functions:

- 1 Press **MENU**, then press **CH+** or **CH-** repeatedly until the *Function* menu appears.





Video	Language	English	<input type="button" value="Left"/>	<input type="button" value="Right"/>
Audio	OSD Timeout	Short	<input type="button" value="Left"/>	<input type="button" value="Right"/>
Channel	OSD Transparency	Medium	<input type="button" value="Left"/>	<input type="button" value="Right"/>
Function	Screen Mode	Full screen	<input type="button" value="Left"/>	<input type="button" value="Right"/>
Lock	Blue Screen	On	<input type="button" value="Left"/>	<input type="button" value="Right"/>
	DPMS	On	<input type="button" value="Left"/>	<input type="button" value="Right"/>
	Time Setup		<input type="button" value="Left"/>	<input type="button" value="Right"/>
	Closed Caption		<input type="button" value="Left"/>	<input type="button" value="Right"/>
	Default		<input type="button" value="Left"/>	<input type="button" value="Right"/>
<input type="button" value="Function"/> <input type="button" value="CH+/VOL+"/> Select <input type="button" value="EXIT"/> Back				

- 2 Press **VOL+** or **ENTER** to open the *Function* menu.
- 3 Press **CH+** or **CH-** to select an option, then press **VOL+** or **VOL-** to adjust the option. You can select:
 - **Language**—Selects the language for the menu. You can select **English**, **French**, or **Spanish**.
 - **OSD Timeout**—Sets the amount of time the menu stays open after the last button press before it automatically turns off. You can select **Medium**, **Short**, or **Long**.
 - **OSD Transparency**—Selects the menu transparency. You can select **Low**, **High**, or **Medium**.
 - **Screen Mode**—Selects the screen mode. You can select **Full Screen**, **Normal**, **Wide**, **Zoom**, or **Cinema**. The **Screen Mode** options may vary depending on the video input source.
 - **Blue Screen**—Turns the blue screen **On** or **Off**. If you turn on this option, the screen will turn blue after three seconds without a signal.

- **DPMS**—Sets PC Power Management. If you turn this option **On**, your TV/DVD combo will go into standby after no signal is received from a computer for two minutes. If the computer sends a signal, your TV/DVD combo turns back on.
- **Time Setup**—Opens a sub-menu where you can set up the time options. See “Setting the time” on page 16.
- **Closed Caption**—Opens a sub-menu where you can set the Closed Captioning options. See “Using closed captions” on page 16.
- **Default**—Opens a dialog box where you can reset the TV settings to factory default.

Using the DVD player

Playable discs

Type	Label	Contents	Size
DVD video		Audio and video	12 cm
Audio CD		Audio	12 cm
JPEG		Pictures	12 cm
Kodak CD		Pictures	12 cm
CD-R	CD-R	Audio and video	12 cm
CD-RW	CD-RW	Audio and video	12 cm
CD+G	CD+G	Audio and pictures	12 cm
MPEG4		Audio and video	12 cm

- You cannot play discs other than those listed in the table.
- You cannot play non-standardized discs, even if they have one of the label types in the table.
- The performance of a CD-R or CD-RW disc depends on the way the disc was burned. In a few cases, disc performance may not be consistent or the disc may not play at all.

Region codes



Your TV/DVD combo is designed and manufactured according to the Region Management Information that is recorded on a DVD disc. If the region code listed on the DVD does not correspond to your TV/DVD combo's region number the DVD player will not play. Your TV/DVD combo plays DVDs with region codes **1** or **ALL**.

Playing a disc

To play a disc:

- 1 Press **DVD** to select DVD mode.
- 2 When **OPEN** appears on the screen, insert the disc.
Caution: Do not insert the disc until you see the OPEN message.

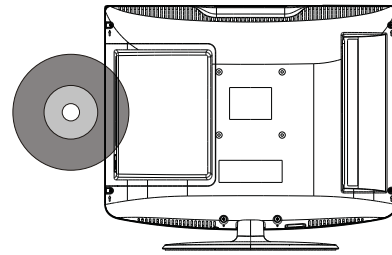

- 3 If the disc does not start playing automatically, press **PLAY/ENTER**.
- 4 To stop playback, press **■ STOP**.

Controlling disc playback

To control disc playback:

- To pause playback, press **⏸ PAUSE**. Sound is muted in pause mode. To resume playback, press **▶ PLAY/ENTER**.
- To go to the beginning of the current chapter or track, press **⏮ PREV**.
- To go to the previous chapter or track, press **⏮ PREV** twice. Each time you press this button, your TV/DVD combo skips back one chapter or track.
- To go to the next chapter or track, press **▶ NEXT**. Each time you press this button, your TV/DVD combo skips forward one chapter or track.
- To fast-reverse on a disc, press **⏪ REV**. Each time you press this button the fast-reverse speed changes.
- To fast-forward on a disc, press **▶▶ FWD**. Each time you press this button the fast-forward speed changes.

Playing a JPEG disc

To play a JPEG disc:

- 1 Turn on your TV/DVD combo.
- 2 Press **DVD** to select DVD mode.
- 3 When **OPEN** appears on the screen, insert the disc. A navigation menu opens.
Caution: Do not insert the disc until you see the OPEN message.
- 4 Press the **▲** or **▼** arrow button to select a file, then press **▶ PLAY/ENTER**.

Selecting a subtitle language

Note: The number of subtitle languages available depends on the DVD. Some DVDs do not have subtitles.

To select a subtitle language:

- Press **SUBTITLE** repeatedly to select the subtitle language you want. **SUBTITLE 01/XX XXXXX** appears on the screen. **01** indicates the original disc language. **XX** indicates the total number of available subtitle languages. **XXXXX** indicates the country for the selected language.

Repeating a section of a disc

Note: For discs other than DVDs, this function may work differently.

To repeat a section of a disc:

- 1 Press **REPEAT**. Your TV/DVD combo repeats the current chapter.
- 2 Press **REPEAT** again. Your TV/DVD combo repeats the current title.
- 3 Press **REPEAT** again. Your TV/DVD combo repeats the entire DVD.
- 4 Press **REPEAT** again to return to normal playback.

Creating a playback loop

Note: For discs other than DVDs, this function may work differently.

To create a playback loop:

- 1 Locate the starting point for the loop, then press **A-B**.
- 2 Play the disc until you reach the stopping point for the loop, then press **A-B**. Your TV/DVD combo plays the loop.
- 3 To cancel the loop and return to normal playback, press **A-B** again.

Selecting a viewing angle

Some DVDs include scenes that have multiple viewing angles.

To select a viewing angle:

- Press **ANGLE** repeatedly.

Using a DVD main menu

Note: Some DVDs do not have menus.

To use a DVD main menu:

- 1 Press **MENU**.
- 2 Use the arrow buttons to select an option, then press **PLAY/ENTER**.

Using a DVD title menu

Note: Some DVDs do not have menus.

To use a DVD title menu:

- 1 Press **TITLE**.
- 2 Use the arrow buttons to select an option, then press **PLAY/ENTER**.

Displaying disc information

Note: For discs other than DVDs, this function may work differently.

To display disc information:

- 1 Press **DISPLAY** once to display the Title Elapsed time.
- 2 Press **DISPLAY** again to display the Title Remaining time.
- 3 Press **DISPLAY** again to display the Chapter Elapsed time.
- 4 Press **DISPLAY** again to display the Chapter Remaining time.
- 5 Press **DISPLAY** again to turn off the display.

Using program play

To use program play:

- 1 Press **PROGRAM**.
- 2 Press the number buttons for the program you want to play.
- 3 Press the arrow buttons to select **START**.
- 4 Press **PLAY/ENTER**.

Searching for a scene

To search for a scene on a DVD:

- 1 Press **T.SEARCH**. The search menu opens.
- 2 Press the number buttons for the scene you want.

Playing a DVD in slow motion

Note: This function does not work for CDs.

To play a DVD in slow motion:

- 1 Press **SLOW** repeatedly. Each time you press this button the slow-motion speed changes.
- 2 To resume normal playback, press **PLAY/ENTER**.

Selecting the audio mode

To select the audio mode:

- Press **AUDIO** repeatedly to select the audio mode you want.

Note: You must wait three seconds between button presses.

You can select:

- **Audio 1/2: AC3 2 CH English**
- **Audio 2/2: AC3 5.1 English**
- **Mono Left**
- **Mono Right**
- **Mix-Mono**
- **Stereo**

Using the DVD setup menus

To use the DVD setup menus:

- 1 Press **SETUP**. The *General Setup Page* menu opens. If you press **SETUP** again, the *Preference Page* menu opens.
Note: The Preference page only opens when no disc is in the disc slot.
- 2 Press **▲** or **▼** to highlight an option, then press **▶** to select the option.
- 3 Press **▲** or **▼** to adjust the option, then press **PLAY/ENTER** to save your setting.
- 4 Press **SETUP** repeatedly to exit.

General Setup Page

..General Setup Page..		
Tv Display	4 : 3 LB	4: 3/Ps
Angle Mark	On	4: 3/Lb
Osd Lang	ENG	16: 9
Caption	On	
Screen Saver	Off	
Hdcd	Off	
Last Memory	Off	

Option	Description
Tv Display	Select the aspect ratio. When using your TV/DVD combo to view a DVD, select 4:3/LB . When using an external TV to view a DVD, you can select: 4:3/PS —Pan and Scan. Widescreen images are displayed with the left and right edges cropped. 4:3/LB —Letter Box. Widescreen images are displayed without cropping, but black bars appear at the top and bottom of the image. 16:9 —Widescreen images fill the screen. If the DVD was recorded in ultra widescreen format, black bars appear at the top and bottom of the image.
Angle Mark	Turns the angle mark on and off. If this option is turned on and the DVD you are watching has scenes with multiple viewing angles, the angle mark appears on the screen when multiple screens are available.
Osd Lang	Select the language for the setup menus.
Caption	Turns closed captions on or off.
Screen Saver	Turns the screen saver option on or off. When this option is turned on, your TV/DVD combo displays an animated picture whenever the DVD player is idle for more than three minutes.
Hdcd	Lets you select the CD format. You can select: Off —Plays normal (standard) CDs. 1X —Plays HDCDs in 44.1 K format. 2X —Plays HDCDs in 88.2 K format.
Last Memory	Turn the last memory option on and off. If this option is turned on, your TV/DVD combo remembers the DVD chapter you were viewing when you turn off your TV/DVD combo. When you turn your TV/DVD combo back on, it starts playback at the chapter you were last viewing.

Preference Page

Note: The Preference page only opens when no disc is in the disc tray.

..Preference Page..	
Parental	1 Kid Saf
Password	2 G
Default	3 Pg
	4 Pg 13
	5 Pgr
	6 R
	7 Nc17
	8 Adult

Option	Description
Parental	Turns parental controls on or off and sets the rating level. The rating level you select and all higher ratings are blocked. You can select: <ul style="list-style-type: none"> • 1 Kid Saf • 2 G • 3 Pg • 4 Pg 13 • 5 Pgr • 6 R • 7 Nc17 • 8 Adult When you select the Parental option, you must enter the password. The default password is 1234 .
Password	Sets the password. The password must be four digits. The first time you select this option, press the number keys to enter 1234 , then press the number keys to enter your new password twice. If you forget your password, enter 1369 .
Default	Reset all settings (except the password and parental rating level) to the factory defaults. Select this option, then press PLAY/ENTER .

Maintaining

Cleaning the cabinet

Wipe the front panel and other exterior surfaces of your TV/DVD combo with a soft cloth lightly dampened with lukewarm water.

Never use a solvent or alcohol to clean your TV/DVD combo. Do not spray insecticide near your TV/DVD combo. Such chemicals may cause damage and discoloration to the exposed surfaces.

Handling discs

A dirty, scratched, or warped disc may cause skipping or noise.

To care for discs:



- Hold discs by their edges.
- Store discs in their cases when you are not using them.
- Do not expose discs to direct sunlight, high humidity, high temperature, or dust. Prolonged exposure to extreme temperatures can warp discs.
- Do not stick labels or tape on discs.

Cleaning discs

To clean a disc:

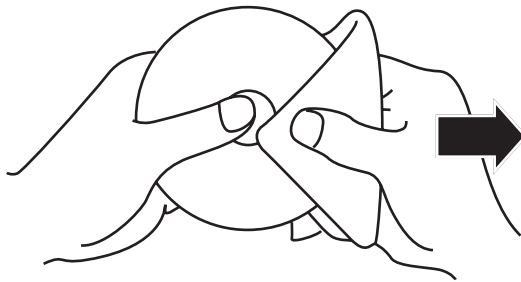

- With a soft cloth, wipe the disc from the center to the outer edge.
Caution: Do not use detergent or abrasive cleaning agents. They will damage the disc surface.

Troubleshooting

Problem	Solution
No picture, no sound	<ul style="list-style-type: none"> • Make sure that your TV/DVD combo is plugged into a power outlet. • Make sure that the power outlet is supplying power. Try plugging a lamp into the outlet and turning it on.
Blank screen	<ul style="list-style-type: none"> • Make sure that you have selected the correct video input source. For more information, see "Selecting the video input source" on page 13. • If power was interrupted, turn off your TV/DVD combo, then turn it back on.
No sound	<ul style="list-style-type: none"> • Press MUTE to make sure that the sound has not been muted. • Press VOL+ to make sure that the volume is not set too low. • Try another station. The problem may be with the broadcaster.
Poor sound	<ul style="list-style-type: none"> • Adjust the sound. For more information, see "Adjusting the audio" on page 14.
No picture on some channels	<ul style="list-style-type: none"> • Make sure that the correct channel is selected. • Adjust the antenna.
No color for some channels	<ul style="list-style-type: none"> • Try another channel. The problem may be with the broadcaster. • Adjust the color. For more information, see "Adjusting the picture" on page 13.
Spots on some channels	<ul style="list-style-type: none"> • Make sure that the antenna is connected correctly and securely. • Make sure that the antenna and antenna cabling is in good condition. • Adjust the picture using the FINE TUNE option.
Abnormal functioning	<ul style="list-style-type: none"> • Disconnect your TV/DVD combo from the power outlet, wait about 10 seconds, then reconnect the power. If the problem still exists, contact authorized service personnel.

Specifications

Design and specifications are subject to change without notice.
Dimensions listed in this *User Guide* are approximate.

Model	19"
Picture and sound system	NTSC, ATSC, Clear QAM
Audio output	≥3 W + 3 W
External input jacks	AV input PC input S-Video input PC audio input YPbPr (component) input HDMI input Antenna input
Power requirements	~120 V 60 Hz
Power consumption	≤80 W
Temperature	Operating: 41° ~ 95°F (5° ~ 35°C) Storage: 5° ~ 113°F (-15° ~ 45°C)
Humidity	Operating: 20% ~ 80% Storage: 5% to 90%
Dimensions H × W × D	18.2 × 7.1 × 15.3 in. (46.2 × 18.0 × 38.9 cm)
Weight	10.8 lbs. (4.9 kg)
Accessories	Remote control AA batteries (2) User Guide

Legal notices

FCC Part 15

This device complies with Part 15 of the FCC Rules. Operation of this product is subject to the following two conditions: (1) this device may not cause harmful interference, and (2) this device must accept any interference received, including interference that may cause undesired operation.

FCC warning

Changes or modifications not expressly approved by the party responsible for compliance with the FCC Rules could void the user's authority to operate this equipment.

DHHS and FDA safety certification

This product is made and tested to meet safety standards of the FCC, requirements and compliance with safety performance of the U.S. Department of Health and Human Services, and also with FDA Radiation Performance Standards 21 CFR Subchapter J.

One-Year Limited Warranty

Dynex Products ("Dynex") warrants to you, the original purchaser of this new **DX-LTDVD19-09** ("Product"), that the Product shall be free of defects in the original manufacture of the material or workmanship for a period of one (1) year from the date of your purchase of the Product ("Warranty Period"). This Product must be purchased from an authorized dealer of Dynex brand Products and packaged with this warranty statement. This warranty does not cover refurbished product. If you notify Dynex during the Warranty Period of a defect covered by this warranty that requires service, terms of this warranty apply.

How long does the coverage last?

The Warranty Period lasts for one year (365 days) from the date you purchased the Product. The purchase date is printed on the receipt you received with the Product.

What does this warranty cover?

During the Warranty Period, if the original manufacture of the material or workmanship of the Product is determined to be defective by an authorized Dynex repair center or store personnel, Dynex will (at its sole option): (1) repair the Product with new or rebuilt parts; or (2) replace the Product at no charge with new or rebuilt comparable products or parts. Products and parts replaced under this warranty become the property of Dynex and are not returned to you. If service of products and parts are required after the Warranty Period expires, you must pay all labor and parts charges. This warranty lasts as long as you own your Dynex Product during the Warranty Period. Warranty coverage terminates if you sell or otherwise transfer the Product.

How to obtain warranty service?

If you purchased the Product at a retail store location, take your original receipt and the Product to the store you purchased it from. Make sure that you place the Product in its original packaging or packaging that provides the same amount of protection as the original packaging. If you purchased the Product from an online web site, mail your original receipt and the Product to the address listed on the web site. Make sure that you put the Product in its original packaging or packaging that provides the same amount of protection as the original packaging.

To obtain in-home warranty service for a television with a screen 25 inches or larger, call 1-888-BESTBUY. Call agents will diagnose and correct the issue over the phone or will have an Dynex-approved repair person dispatched to your home.

Where is the warranty valid?

This warranty is valid only to the original purchaser of the Product in the United States, Canada, and Mexico.

What does the warranty not cover?

This warranty does not cover:

- Customer instruction
- Installation
- Set up adjustments
- Cosmetic damage
- Damage due to acts of God, such as lightning strikes
- Accident
- Misuse
- Abuse
- Negligence
- Commercial use
- Modification of any part of the Product
- Plasma display panel damaged by static (non-moving) images applied for lengthy periods (burn-in).

This warranty also does not cover:

- Damage due to incorrect operation or maintenance
- Connection to an incorrect voltage supply
- Attempted repair by anyone other than a facility authorized by Dynex to service the Product
- Products sold as is or with all faults
- Consumables, such as fuses or batteries
- Products where the factory applied serial number has been altered or removed

REPAIR REPLACEMENT AS PROVIDED UNDER THIS WARRANTY IS YOUR EXCLUSIVE REMEDY. DYNEX SHALL NOT BE LIABLE FOR ANY INCIDENTAL OR CONSEQUENTIAL DAMAGES FOR THE BREACH OF ANY EXPRESS OR IMPLIED WARRANTY ON THIS PRODUCT, INCLUDING, BUT NOT LIMITED TO, LOST DATA, LOSS OF USE OF YOUR PRODUCT, LOST BUSINESS OR LOST PROFITS. DYNEX PRODUCTS MAKES NO OTHER EXPRESS WARRANTIES WITH RESPECT TO THE PRODUCT, ALL EXPRESS AND IMPLIED WARRANTIES FOR THE PRODUCT, INCLUDING, BUT NOT LIMITED TO, ANY IMPLIED WARRANTIES OF AND CONDITIONS OF MERCHANTABILITY AND FITNESS FOR A PARTICULAR PURPOSE, ARE LIMITED IN DURATION TO THE WARRANTY PERIOD SET FORTH ABOVE AND NO WARRANTIES, WHETHER EXPRESS OR IMPLIED, WILL APPLY AFTER THE WARRANTY PERIOD. SOME STATES, PROVINCES AND JURISDICTIONS DO NOT ALLOW LIMITATIONS ON HOW LONG AN IMPLIED WARRANTY LASTS, SO THE ABOVE LIMITATION MAY NOT APPLY TO YOU. THIS WARRANTY GIVES YOU SPECIFIC LEGAL RIGHTS, AND YOU MAY ALSO HAVE OTHER RIGHTS, WHICH VARY FROM STATE TO STATE OR PROVINCE TO PROVINCE.

Contact Dynex:

For customer service please call 1-800-305-2204

www.dynexproducts.com

Distributed by Best Buy Purchasing, LLC

7601 Penn Avenue South, Richfield, Minnesota, U.S.A. 55423-3645

© 2008 Best Buy Enterprise Services, Inc.

All rights reserved. DYNEX is a trademark of Best Buy Enterprise Services, Inc. Registered in some countries. All other products and brand names are trademarks of their respective owners.

DYNEX™

ENGLISH
08-1557

www.dynexproducts.com (800) 305-2204

Distributed by Best Buy Purchasing, LLC
7601 Penn Ave. South, Richfield, MN 55423 U.S.A.

© 2008 Best Buy Enterprise Services, Inc. All rights reserved.

DYNEX is a trademark of Best Buy Enterprise Services, Inc. Registered in some countries. All other products and brand names are trademarks of their respective owners.

Free Manuals Download Website

<http://myh66.com>

<http://usermanuals.us>

<http://www.somanuals.com>

<http://www.4manuals.cc>

<http://www.manual-lib.com>

<http://www.404manual.com>

<http://www.luxmanual.com>

<http://aubethermostatmanual.com>

Golf course search by state

<http://golfingnear.com>

Email search by domain

<http://emailbydomain.com>

Auto manuals search

<http://auto.somanuals.com>

TV manuals search

<http://tv.somanuals.com>