

dyson

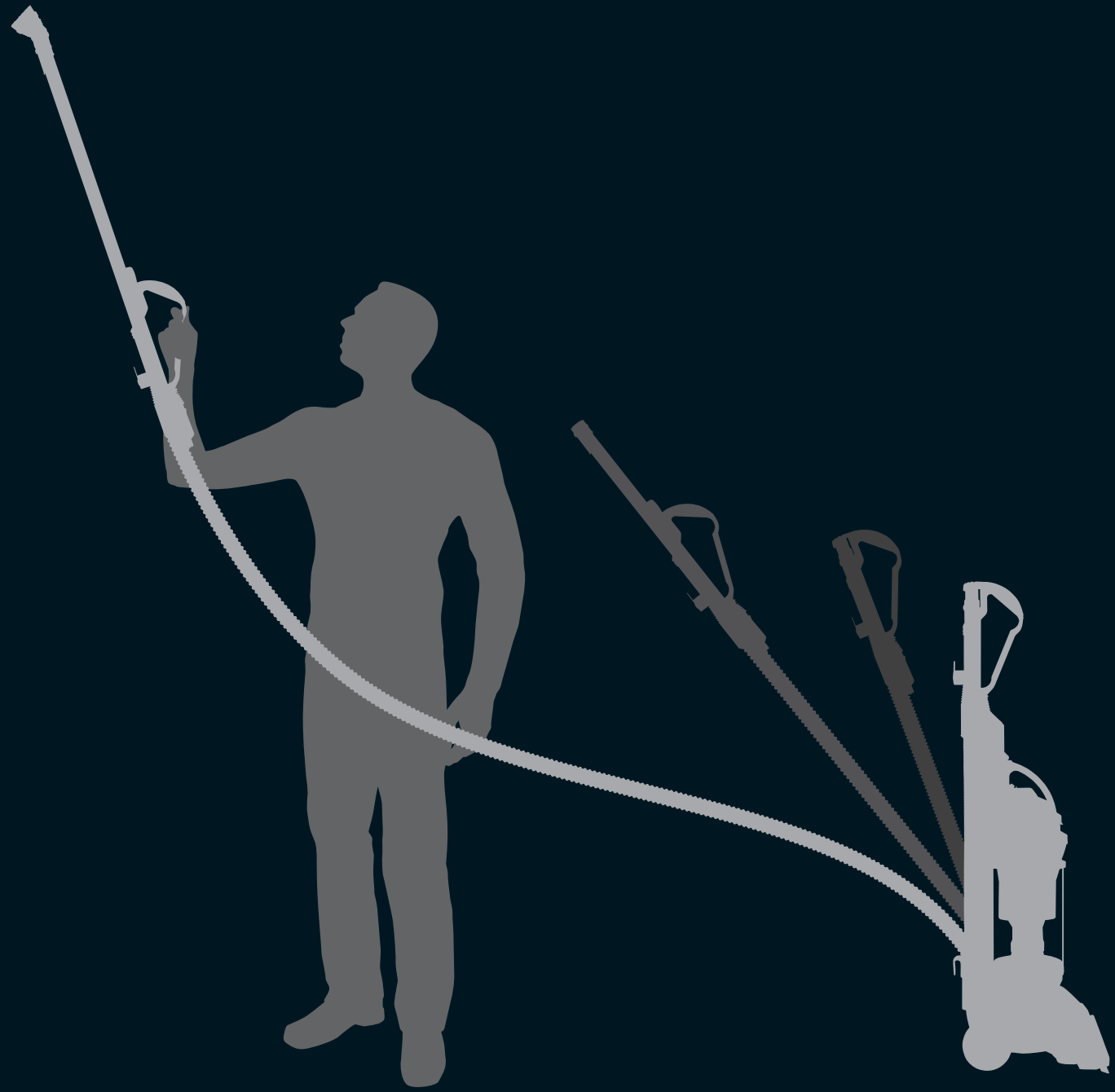

Owner's manual
Please read this guide carefully
before using your DC14.

Manuel d'utilisation
Veuillez lire attentivement ce
manuel avant d'utiliser votre DC14.

**DC
14**

IMPORTANT SAFETY INSTRUCTIONS

READ ALL INSTRUCTIONS BEFORE USING THIS VACUUM CLEANER

When using an electrical appliance, basic precautions should always be followed, including the following:

WARNING

TO REDUCE THE RISK OF FIRE, ELECTRIC SHOCK OR INJURY:

- 1 Do not leave appliance when plugged in. Unplug from electrical outlet when not in use and before servicing.
- 2 Do not use outdoors or on wet surfaces or to vacuum water or other liquids – electric shock and personal injury could occur.
- 3 Do not allow to be used as a toy. Close attention is necessary when used near children.
- 4 You are responsible for making sure that your vacuum cleaner is not used by children or by anyone unable to operate it properly.
- 5 Use only as described in this manual. Use only with Dyson recommended or approved attachments and accessories.
- 6 Check to ensure your electricity supply corresponds to that shown on the rating plate, which can be found on the base of the machine between the wheels. The machine must only be used as rated.
- 7 Do not use with a damaged cord or plug. If the machine is not functioning properly, has been dropped, damaged, left outdoors, or immersed in liquid, do not use the machine and contact the Dyson Helpline at 1-877-397-6622.
- 8 Do not pull or carry by the cord, do not use the cord as a handle, do not close a door on the cord or pull the cord around sharp edges or corners. Do not run the machine over the cord. Keep the cord away from heated surfaces and open flames.
- 9 Do not unplug by pulling on the cord. To unplug, grasp the plug, not the cord.
- 10 Do not handle the plug or machine with wet hands.
- 11 Do not use the machine without the Clear bin™ and the filters in place.
- 12 Do not put any objects into openings in the machine. Do not use with any opening blocked; keep free of dust, lint, hair and anything that may reduce air flow.
- 13 Keep hair, loose clothing, fingers, and all parts of body away from openings in the machine and moving parts such as the brushbar.
- 14 Do not use the machine to pick up sharp hard objects, small toys, pins, paper clips etc. because they may damage the machine.
- 15 The use of an extension cord is not recommended.
- 16 Store the machine indoors. Put the machine away after use with the cord coiled safely, to prevent tripping accidents.
- 17 Turn off all controls before unplugging.
- 18 Take extra care when cleaning on stairs; always work with the machine at the bottom of the stairs. Do not put the machine on chairs, tables etc, keep it on the floor.
- 19 Do not pick up anything that is burning or smoking, such as cigarettes, matches, or hot ashes.
- 20 Do not use to pick up flammable or combustible liquids, such as gasoline, or use in areas where they may be present.
- 21 When vacuuming, certain carpets may generate small static charges in the Clear bin™ or wand. These are not associated with the electricity supply. To minimize any effect from this, do not put your hand or insert any object into the Clear bin™ unless you have first emptied it and rinsed it out with cold water.
- 22 Use only identical Dyson replacement parts.
- 23 Do not carry out any maintenance or repair work other than that shown in this manual or advised by the Helpline.

SAVE THESE INSTRUCTIONS

THIS APPLIANCE IS INTENDED FOR HOUSEHOLD USE ONLY

Polarization instructions

To reduce the risk of electric shock, this appliance has a polarized plug (1 blade is wider than the other). This plug will fit in a polarized outlet only one way. If the plug does not fit fully in the outlet, reverse the plug. If it still does not fit, contact a qualified electrician to install the proper outlet. Do not change the plug in any way.

Owner's manual

Please read this guide carefully before using your DC14.

Important safety instructions	Page 2
Box contents	4
Assembling your DC14	5
Using your DC14	6
Using your DC14 tools	7
Emptying the Clear bin™	8
Cleaning the Clear bin™	9
Washing the filter	10
Finding blockages	11
Brushbar maintenance	12
Accessory instructions	13
DC14 accessories	15
Warranty and customer care	16

Box contents

CAUTION

- Please see the back of the manual for optional accessories.
- If you have any questions, please call the Dyson Helpline at 1-877-397-6622 or log on to www.dyson.com

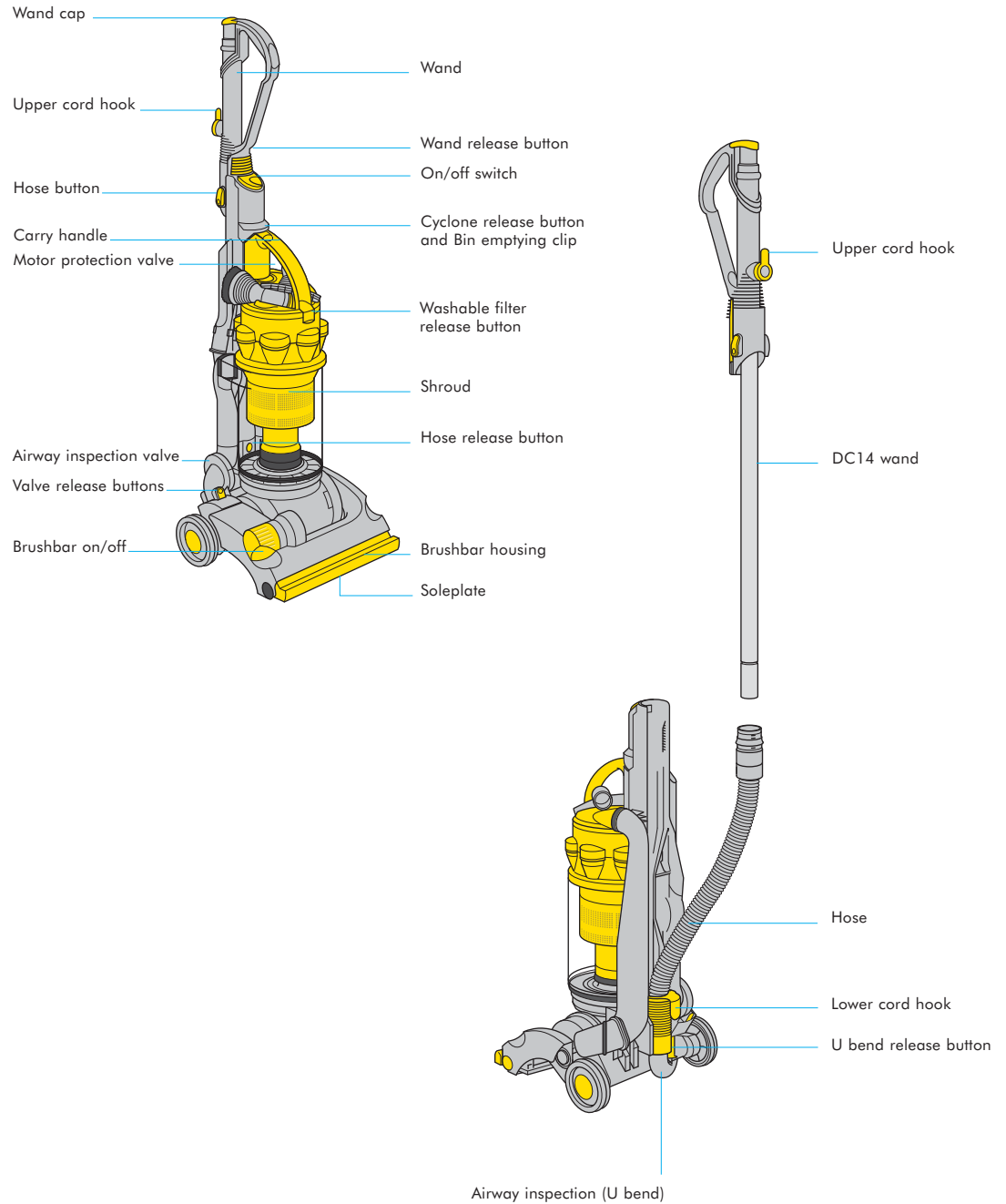
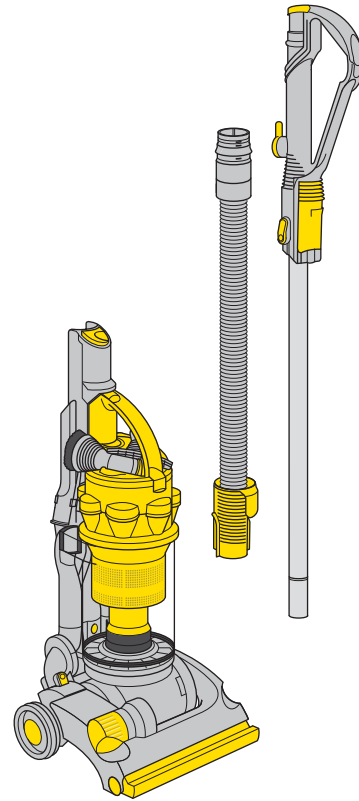
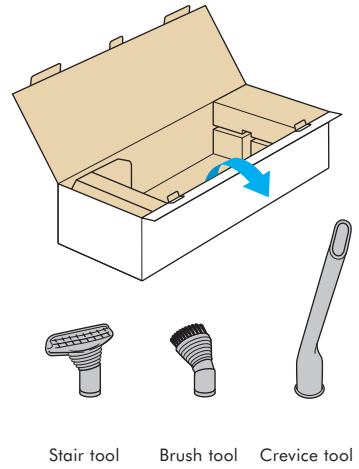

Assembling your DC14

⚠ CAUTION

- Ensure the wand cap cover is closed.
- Ensure hose is kept straight when inserting wand into hose.
- Do not plug into electrical outlet until fully assembled.

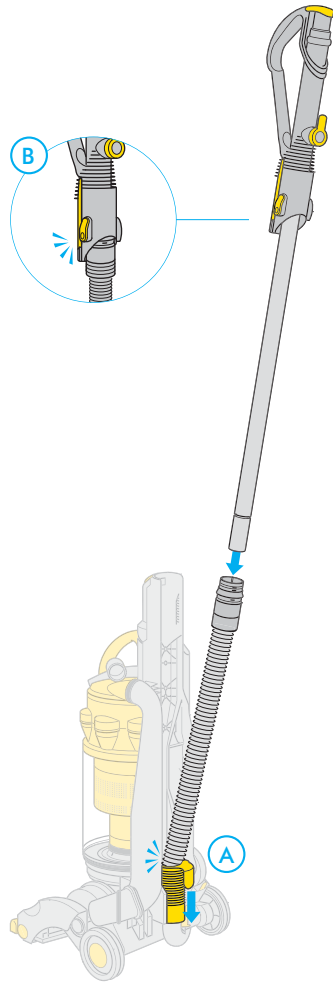

A Slide hose into guides at back of machine and click into place.

B Slide wand straight down in to hose until it clicks into place. Ensure hose does not bend.

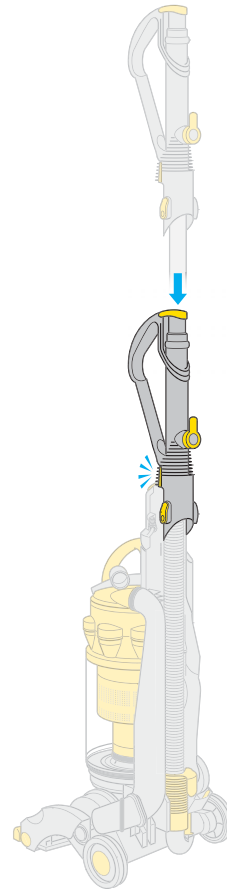

Click wand handle into top of machine.

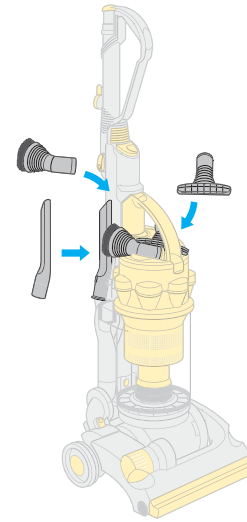

Click tools into place.

Wind cord counter-clockwise around cord hooks and secure with clip. To quickly release cord, rotate upper cord hook.

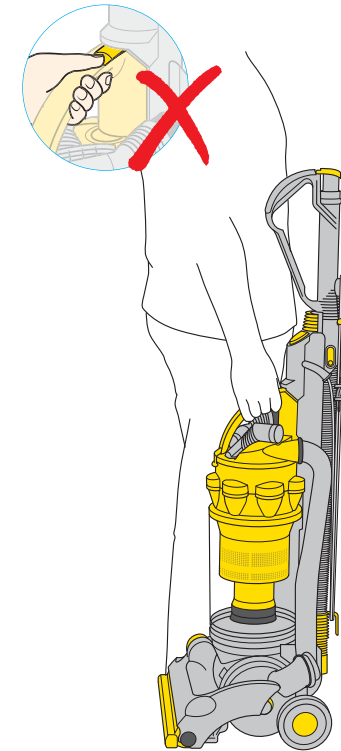
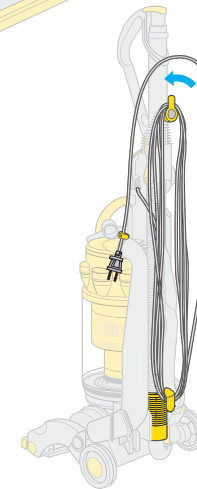

Use the carry handle to lift the machine.

Using your DC14

⚠ CAUTION

- The machine is intended for domestic use only.
- Fine dust such as plaster dust should only be vacuumed in very small amounts.
- **Do not** press the cyclone release button while carrying the machine.
- Ensure the cyclone pack is secured to the machine.
- **Do not** shake the machine while carrying.
- Keep hair and loose fabrics away from wand cap when machine is on.
- Use machine in Bare Floor mode on fine or delicate carpets.
- Ensure the machine is in an upright position before adjusting the setting.

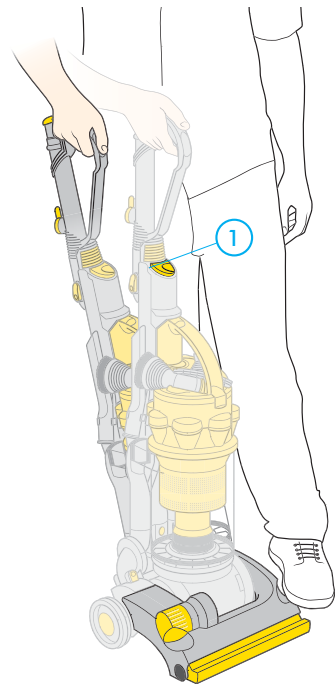
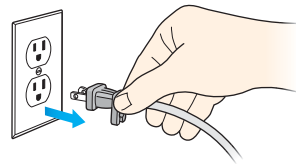

After plugging machine into electric outlet, press on/off button **1**, push cleaner head down with foot and pull handle towards you.

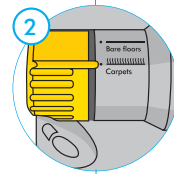
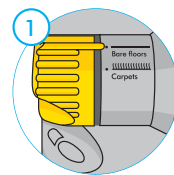
**Brush control system**

- 1 Bare floors:** Use this setting to stop brushbar from turning when vacuuming delicate rugs and bare floors.
- 2 Carpets:** Use this setting so brushbar turns when vacuuming carpets.

Note: the brushbar will not turn until you begin to vacuum.

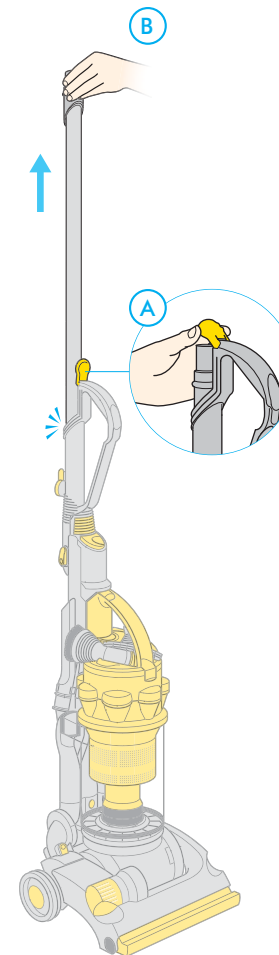
**Tools**

- A** Push back wand cap.
- B** Pull wand from inside wand handle until it locks into place.

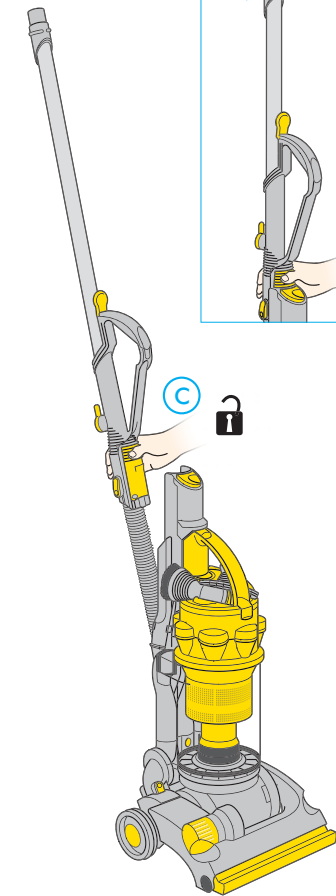
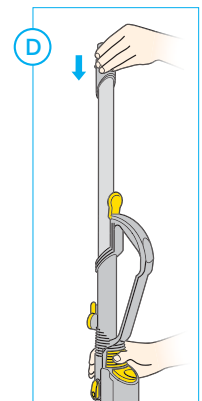

- C** Press button to release hose and wand handle from machine.
- D** To push wand back inside hose, ensure hose is straight. Press the wand release button and push wand back inside wand handle.

Using your DC14 tools

CAUTION

- Powerful suction can cause the hose to 'pull back' in use – please take care when cleaning stairs.
- To avoid personal injury and to prevent the machine from falling when cleaning stairs, always place it at the bottom of the stairs.

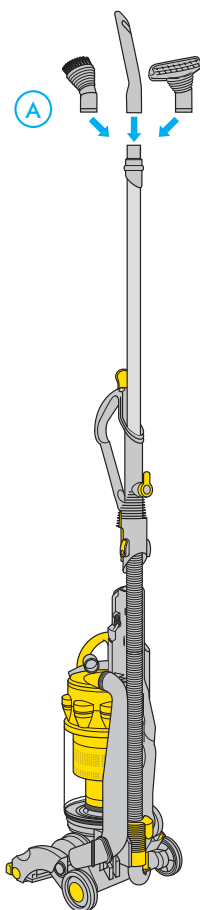

A Tools can be fitted directly to the end of the wand for cleaning hard to reach places.

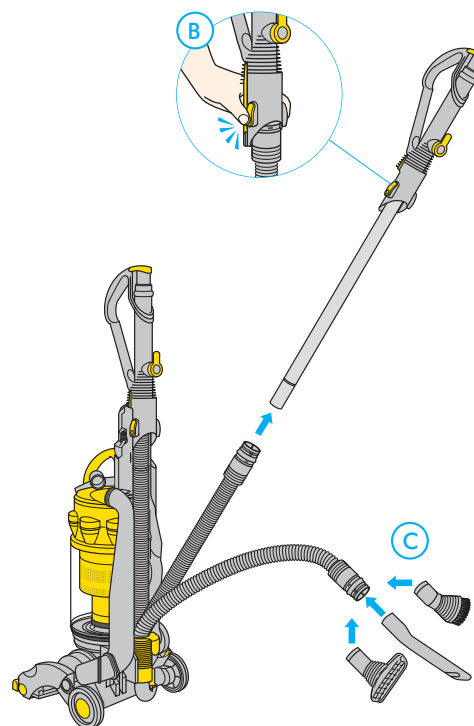

B To fit tools directly to hose, first extend the wand. Then press side buttons to remove wand handle from the hose.

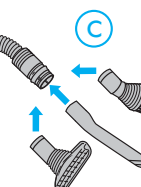

C The tools can be fitted directly to the end of the hose.
For your safety, when the hose is fully extended, grasp firmly by the hose, not the tool.

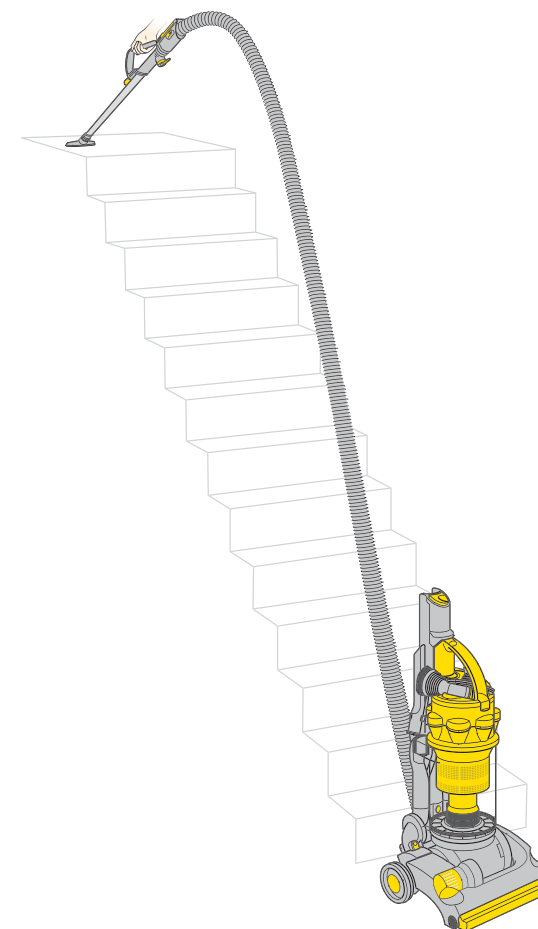

Always work with the machine at the bottom of the stairs.

Emptying the Clear bin™

⚠ CAUTION

- Turn power off and unplug before emptying the bin. Failure to do so could result in electric shock or personal injury.

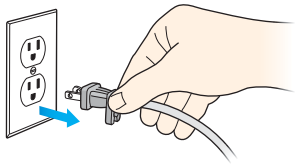

- Do not use the machine without the Clear bin™ in place.

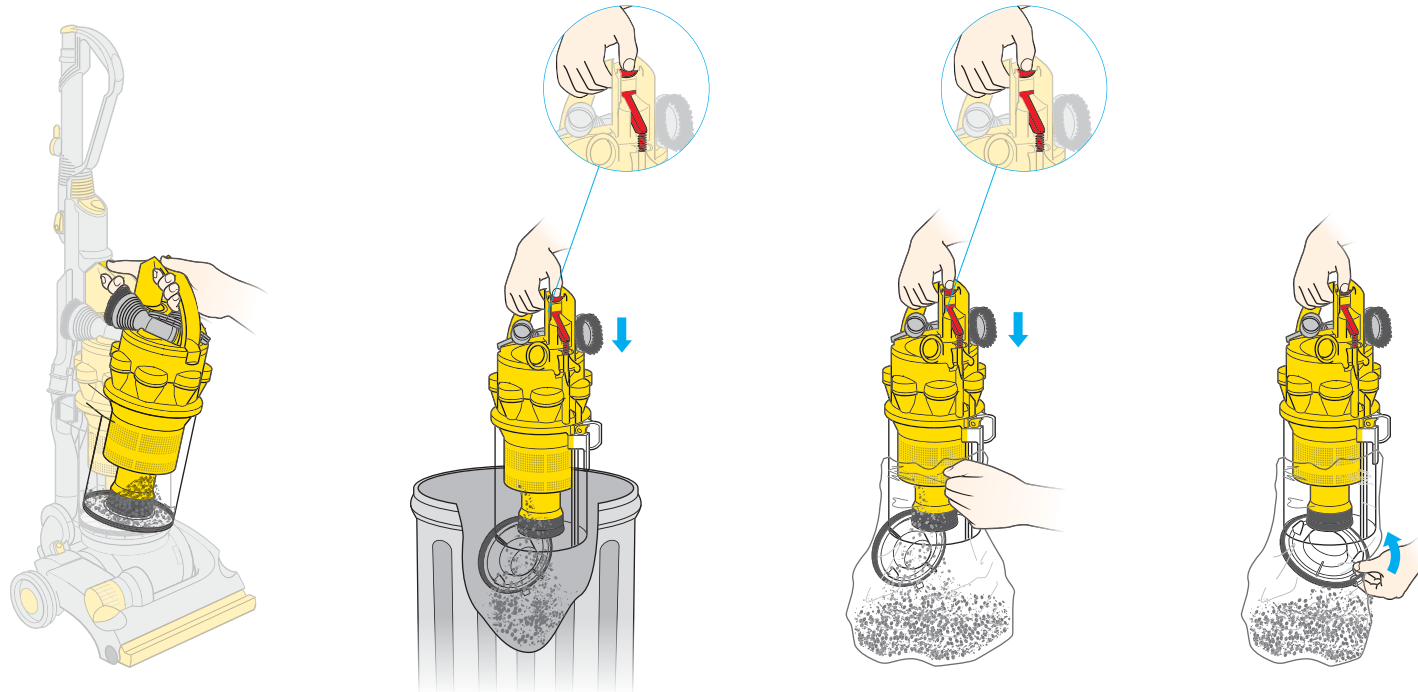

Empty the Clear bin™ as soon as the **MAX** mark is reached. Press cyclone release button to release cyclone from machine.

Option A

Push the red bin emptying button as shown to release the bin base and empty directly into trash.

Option B

Emptying into a bag is recommended for allergy sufferers. Place bin in bag and push red bin emptying button to release bin base.

Let the dust settle, close bin base securely before removing from bag.

Cleaning the Clear bin™

⚠ CAUTION

- **Do not** use detergents, polishes or air fresheners to clean the Clear bin™.
- **Do not** immerse the machine in water.
- Ensure the bin is completely dry before refitting.

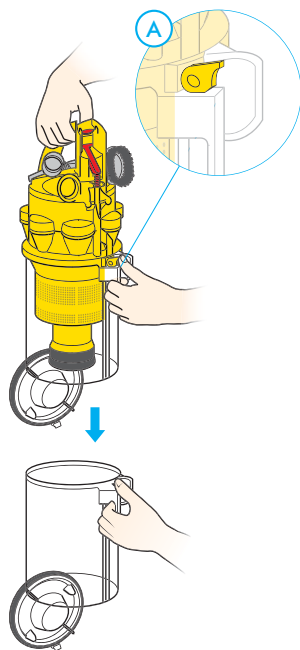

Cleaning the shroud

(if necessary)

Ensure the bin has been emptied and bin base is open.

Press catch **A** to release Clear bin™.

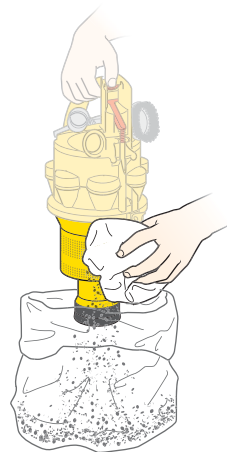

Clean shroud with a cloth or small brush to remove lint or debris.



Cleaning the Clear bin™

Clean Clear bin™ with a cloth or small brush.

- Do not use detergents, polishes or air fresheners.
- Do not immerse the machine in water.
- Ensure the bin is completely dry before refitting.

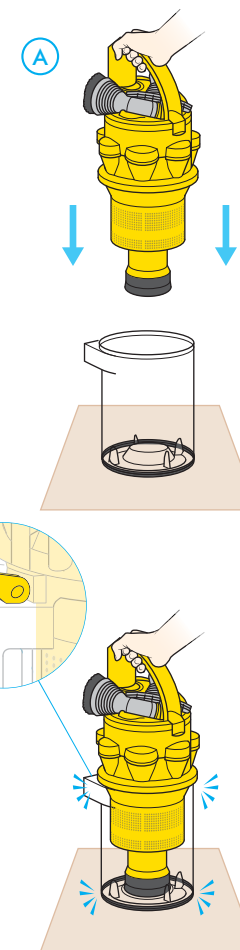

Replacing the bin

A Hold the carry handle and place the cyclone into the Clear bin™.

B Line up the catches and push down to click into place. Ensure the Clear bin™ is secure before replacing on the machine.

Washing the filter at least every 6 months

⚠ CAUTION

- Filter must be washed every 6 months according to instructions to maintain performance.
- Turn power off and unplug before washing the filter. Failure to do so could result in electric shock or personal injury.

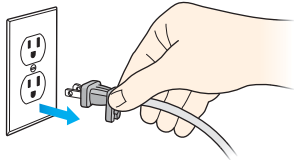

- **Do not** use detergent to clean filter.
- **Do not** put the filter in the dishwasher, washing machine, oven, tumble dryer, microwave or near an open flame.

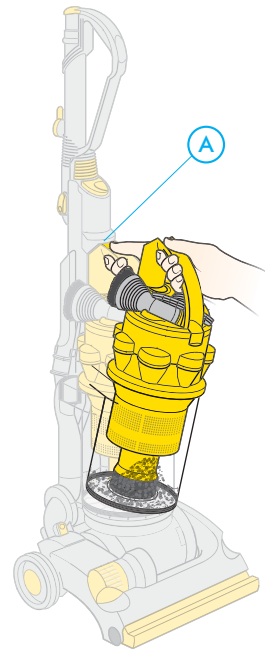

The filter may require washing more frequently than 6 months based on individual vacuuming habits. Press cyclone release button **A** to release cyclone pack.

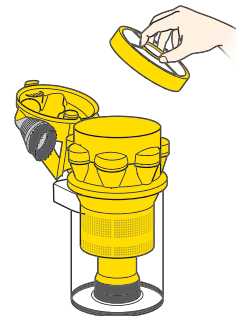
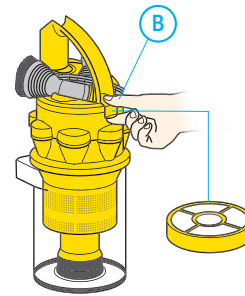

Accessing the filter

Lift washable filter release button **B** and remove filter from machine.



Washing the filter

- Wash filter and case in cold water only.
- Only wash blue foam and yellow cage.
- Do not use detergent.
- Do not put the filter in the dishwasher, washing machine, oven, tumble dryer, microwave or near an open flame.

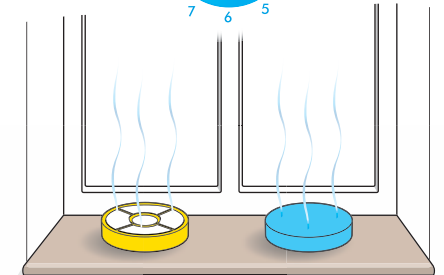

Wash filter and case until water runs clear.

Air dry for at least 12 hours.

Ensure filter and case are completely dry before refitting onto the machine.

Finding blockages

⚠ CAUTION

- Turn power off and unplug before checking for blockages. Failure to do so could result in electric shock or personal injury.

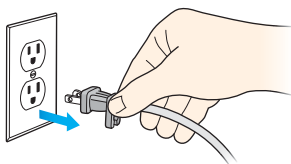

- If any part of your machine becomes blocked, it may overheat and then automatically shut off. Unplug machine and leave to cool down.
- Please note: Clearing blockages is not covered by your machine's limited warranty, please call the Dyson Helpline on 1-877-397-6622.
- Beware of sharp objects when clearing blockages.
- Refit all parts of the machine before using it.
- If you hear a loud ratchet noise it means the brushbar is obstructed.
- Disconnect the machine before removing the obstruction.

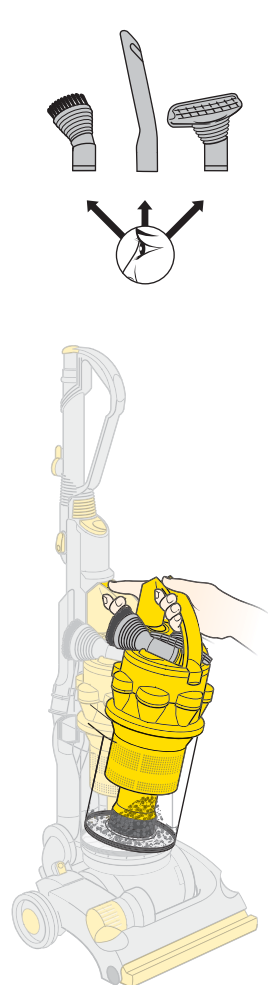

Check tools are clear of blockages.

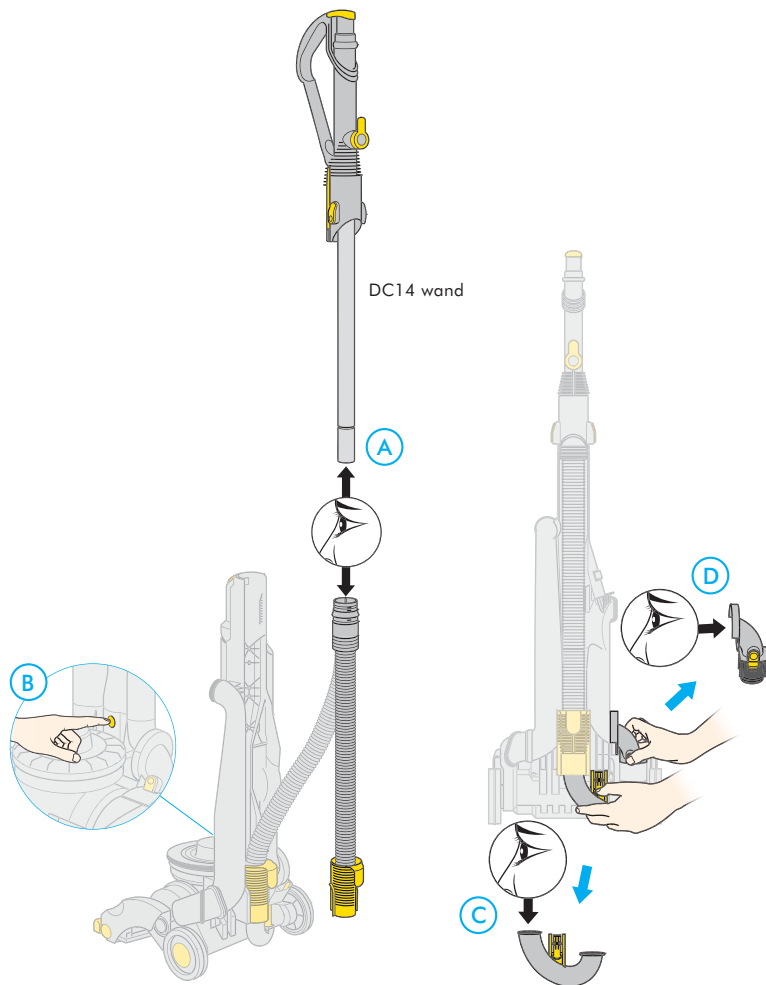

Release wand from vacuum

- A** Remove wand by pressing hose button and sliding hose off wand. Check inside wand and hose for blockages.
- B** Press hose release button at front of machine and slide hose out with lower cord hook at rear.

U bend inspection

- C** Tilt machine forward, slide out U bend and check inside for blockages.

Airway inspection

- D** Squeeze valve release buttons and check inside for blockages.

Brushbar maintenance

CAUTION

- Turn power off, unplug machine and allow machine to cool for 1 hour before brushbar maintenance. Failure to do so could result in electric shock or personal injury.

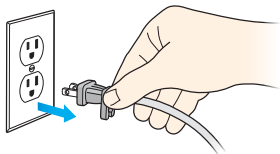

- Ensure soleplate is in correct position before use.
- Make sure all parts have been replaced securely before using your machine.

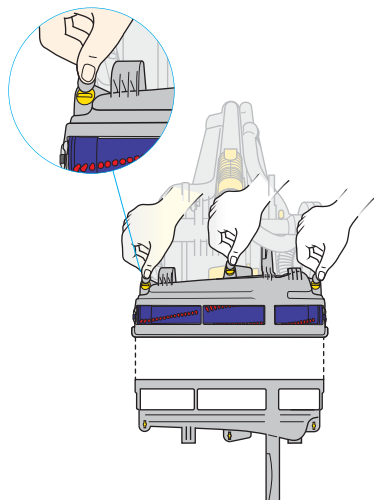

Lie cleaner on its front.
Undo soleplate fasteners using a coin and remove soleplate.

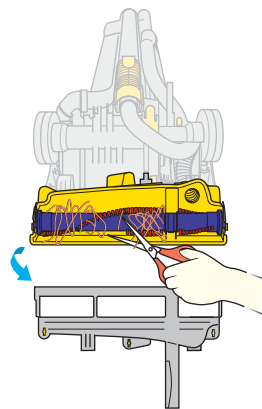

Remove lint and hair from brushbar.

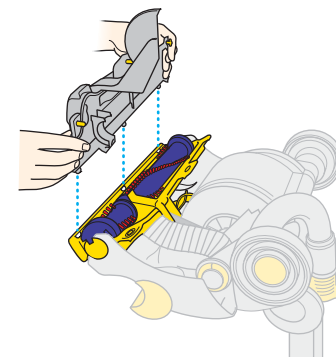

Rest the three tabs on inside of bumper strip and secure soleplate back into position.
Ensure soleplate is in correct position before use.

Instructions for use

Instructions for use

Please read your Dyson Owner's Manual carefully, including the safety instructions, before attaching or using any of the tools.

- Not all accessories available with all models.



Mini Turbine Head

For cleaning confined spaces such as upholstery, stairs and the car.

- Car cleaning

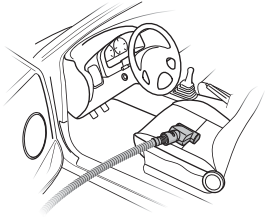

Maintenance indications

- 1 Remove soleplate

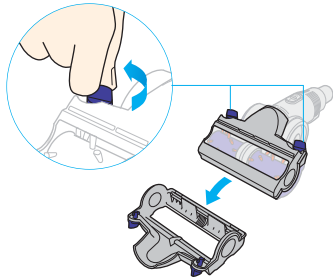

- 2 Remove brushbars

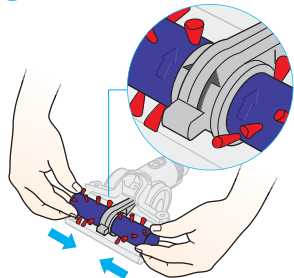

- 3 Replace brushbars

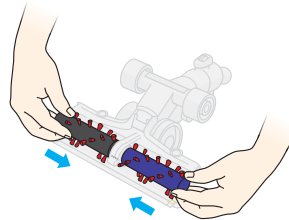

- 4 Replace soleplate

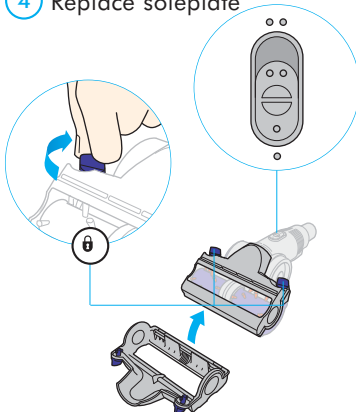

Zorb Carpet powder

- Carpet cleaning

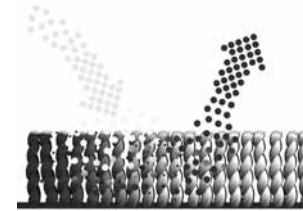

Maintenance indications

- 1 Sprinkle Zorb onto carpet



- 2 Ensure machine is turned off



- 3 Work into carpet pile

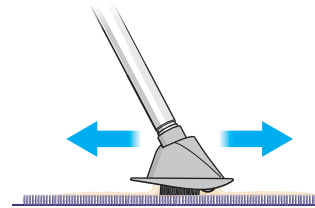

- 4 Vacuum the carpet

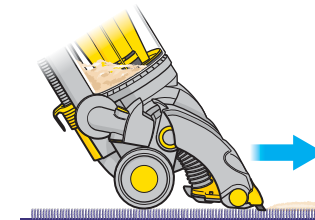

Instructions for use

Instructions for use

Please read your Dyson Owner's Manual carefully, including the safety instructions, before attaching or using any of the tools.

- Not all accessories available with all models.



Low reach floor tool

- Low furniture

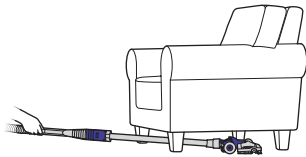

① Carpet – Press rear pedal

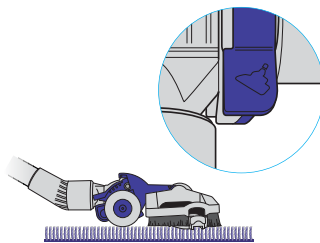

② Bare floors – Press front pedal

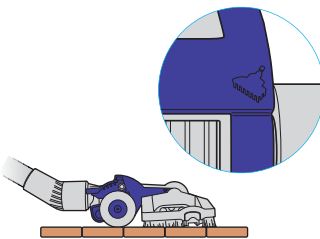

DC14 accessories

These items can be used with your DC14. For further information visit the Dyson website www.dyson.com



Mini turbine head

Improved Mini Turbine head removes dirt and hair from upholstery and stairs.



Flexi crevice tool

Extends and flexes to clean awkward gaps.



Mattress cleaning tool

Picks up dust, dust mites and allergens from your mattress, comforter and cushions.



Cleaning kit 1. Groomer

Long bristles work Zorb carpet maintenance powder deep into carpets.



Soft dusting brush

Soft bristled tool to gently dust around the home. Keeps fans, blinds, TVs and keyboards dust-free.



Extra filter

To replace your filter while it is being washed so you are never without your Dyson vacuum cleaner.



Stiff bristle brush

Stiff bristles remove ground-in and stubborn dirt. Not recommended for use on delicate flooring, rugs or carpets.

2. Zorb carpet maintenance (30oz)

Millions of tiny sponges absorb dirt from the carpet, to keep new carpets looking new with none of the drawbacks of wet cleaning.

3. Dyzolv spot cleaner (230ml)

Contains 4 active agents to clean spots and spills e.g. grease, food, drinks and soil. Ideal for wool and stain resistant carpets and rugs.



Hard floor tool

Long bristled tool prevents damage to delicate floors.



Low reach floor tool

For easier cleaning under low furniture.

Do you need spares or accessories?

Contact the Dyson Helpline at 1-877-397-6622 6 days a week, www.dyson.com

Dyson customer care

Limited 5 year household warranty

Terms and Conditions of the Dyson 5 year limited warranty

If you have a question about your Dyson vacuum cleaner, call the Dyson Helpline at **1-877-397-6622** with your serial number and details of where/when you bought the cleaner. The serial number can be found on the base of your machine between the wheels.

Most questions can be solved over the phone by one of our Helpline staff.

If your cleaner needs service, call the Dyson Helpline we will discuss with you the options available for service. If your machine is under warranty, your machine will be repaired at no cost. To reach the Dyson Helpline call at **1-877-397-6622**, or visit Dyson online at www.dyson.com

Thank you for choosing to buy a Dyson.

To help us ensure you receive prompt and efficient service, please register your purchase with us.

There are two ways to do this:

- You can register by completing and returning the enclosed form to us by post.
- Alternatively you can register on line at www.dyson.com

This will confirm your ownership of your Dyson in the event of an insurance loss, and enable us to contact you if necessary. If you have any questions about your Dyson, please call our customer helpline on 1-877-397-6622, 6 days a week, or log on to our website at www.dyson.com

What is covered





Your Dyson vacuum cleaner is warranted against original defects in material and workmanship for a period of five years from the date of purchase, when used for private household purposes in accordance with the Dyson Owner's Manual. This warranty provides, at no cost to you, all labour and parts to place your vacuum cleaner in proper operating condition during the warranty period. This warranty is subject to the following terms:

What is not covered

Dyson Canada Ltd. shall not be liable for costs, damages, or injuries incurred as a result of:

- Machines purchased from an unauthorized dealer.
- Clearing blockages from your machine.
- Use of parts not assembled in accordance with the Owner's Manual.
- Careless operation or handling, misuse and/or lack of maintenance or use not in accordance with the Owner's Manual.
- External sources such as weather.
- Repairs or alterations carried out by unauthorized parties or agents.
- Use of the vacuum cleaner other than for normal domestic household purposes within Canada, e.g. for commercial or rental purposes.
- Use of parts and accessories other than those produced or recommended by Dyson Canada Ltd.

Note your serial number for future reference:

	
SERIAL NO. 	
 	230-240V 50Hz 1200 W
<small>FOR PATENT INFORMATION SEE OPERATING MANUAL</small> DYSON LIMITED MALMESBURY SN16 0RP ENGLAND UK	

Note your serial number for future reference:

Terms and Conditions (continued)**Warranty Service**

- Please fill out and return the Product Registration Form, or register on line at www.dyson.com
- Before service can take place, the terms of the warranty require that you contact the Dyson Helpline with your model name/number, serial number, date and place of purchase. Please keep your purchase receipt in a safe place to ensure you have this information. The serial number is found on the vacuum cleaner's rating plate, which is on the base of the machine between the wheels.
- All work will be carried out by Dyson Canada Ltd. or its authorized agents.
- Any replaced defective parts will become the property of Dyson Canada Ltd.
- The fitting of replacement parts will not extend the period of this warranty.
- If your machine is not functioning properly, please call the Dyson Helpline on 1-877-397-6622. Most issues can be rectified over the telephone by our trained customer care staff. If this is not possible Dyson Canada Ltd. will arrange for your vacuum cleaner to be repaired and returned in full working order at no extra cost to yourself.

Warranty Limitations and Exclusions

- Any representations, warranties or conditions relating to your vacuum cleaner, express or implied, statutory or otherwise, including but not limited to warranty of merchantability or warranty of fitness for a particular purpose, are limited to the duration of this warranty. This limitation is not allowed by some provinces and so this limitation may not apply to you.
- Your remedy for breach of this warranty is limited to the warranty service described above. Dyson Canada Ltd. will not be liable for any consequential damages or incidental damages you may incur in connection with your purchase and use of your vacuum cleaner. This limitation is not allowed by some provinces and so this limitation may not apply to you.
- In no event shall Dyson Canada Ltd. be liable for any damages arising directly or indirectly from any tort (including negligence or gross negligence) committed by Dyson Canada Ltd., its affiliates, agents or employees, or for any breach of contract, fundamental or otherwise.
- This warranty gives you specific legal rights. You may also have other rights which vary by province.

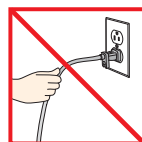

Do not pull on the cord.



Do not place on stairs above you.

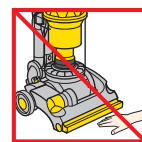

Do not put your hands near the brushbar when in use.



Do not use near open flame.

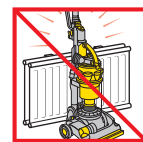

Do not leave cleaner near heat sources.

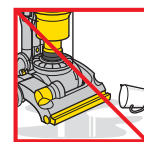

Do not pick up water or liquids.

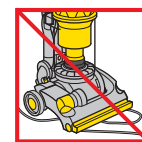

Do not run over the cord.

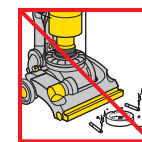

Do not pick up burning objects.

This product is protected by the following intellectual property rights:

Patent/Patent Application numbers:

AU 2005263897; CA 2,574,291; EP 1771104; IN 422/KOLNP/2007; KR 10-2006-7027655; MY 20053364; NZ 552160; RU 2007106901; TW 94124788; US 11/632,821; GB 2407784 A; AU 2005266174
CA 2,575,456; CN 200580025372.9; EP 1786568; IN 323/KOLNP/2007; KR 10-2007-7002254; MY 20053420; NZ 552931; RU 2007107593; TW 94125514; AU 2004294771; CA 2,544,609
CN 200480031447; EP 1680232; HK 06112477.1; IN 1997/DELNP/2006; JP 2006-536152; KR 10-2006-7006143; MY 20044301; NZ 545898; RU 2006120054; TW 93133704; AU 2005263890
CA 2,574,689; EP 1768537; IN 423/KOLNP/2007; KR 10-2007-7000619; MY 20053365; NZ 552161; RU 2007106708; TW 94124617; US 11/632,851; EP1361812; GB 2393383; US 2004/0128789
JP 2004-537336; AU 2003269161; CA 2,497,762; EP1542574; JP 2004-539183; US 10/528,804; WO 2004/028329; AU 2003269349; CA 2,499,017; CN 1684619; EP 1542576; JP 2004-539173
MY 20033606; TW 200414888; US 2006-0162119; AU 744408; EP1119282; JP 2002-527132; US 6,519,807; AU 2002231965; EP 1361813; JP 2002-567126; US 2004-0068829; AU 744362; EP 1121043
JP 2002-527131; US 6,572,078; AU 757043; EP 1052923; US 6,691,849; AU 2002226556; EP 1370172; JP 2004-528876; US 2004-0074213; AU 2002225207; EP1361814; JP 3860541; AU 2001240894
EP 1268076; GB 2360719; JP 2003-528704; US 6,835,222; AU 2002-225232; EP 1361815; GB 2372435; JP 2004-520139; US 6,974,488; GB 2372436; AU 637 272; EP 0636338; JP 1948 863; US 5,078,761

Registered Designs and Design Application numbers:

AU154578; EP 000090865-0001; GB 3012888; JP 1213916; USD 509,332; GB 3015739

Please note: Small details may vary from those shown.

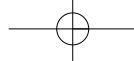

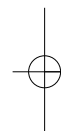
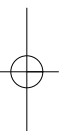
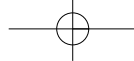

www.dyson.com

Free Manuals Download Website

<http://myh66.com>

<http://usermanuals.us>

<http://www.somanuals.com>

<http://www.4manuals.cc>

<http://www.manual-lib.com>

<http://www.404manual.com>

<http://www.luxmanual.com>

<http://aubethermostatmanual.com>

Golf course search by state

<http://golfingnear.com>

Email search by domain

<http://emailbydomain.com>

Auto manuals search

<http://auto.somanuals.com>

TV manuals search

<http://tv.somanuals.com>