



**DESCRIPTION**

- Compact loudspeaker with no compromise in sound quality
- For portable use or permanent installation
- 100° conical beamwidth
- Passive crossover for single amplifier operation

The JF80z is an ultra compact loudspeaker, engineered for exceptional, near-field performance. It provides surprisingly high output and exceptional fidelity for foreground and background music applications. It's speech projection capabilities also make it very effective as a fill or delay element in larger audio systems. Unlike many compact loudspeakers, the JF80z produces the high impact, high definition sound projection expected in professional PA applications. Its wide angle projection makes audience coverage easy in a variety of situations. While the JF80z is well suited as is for many applications, the addition of a subwoofer can expand its capabilities for more demanding applications.

Foam-backed grilles hide the drivers from view for pleasing aesthetics. Top, bottom and side mounting points allow enclosures to be mounted in virtually any configuration using eyebolts or accessory brackets. Additional mounting points accept an OmniMount® 60.0 Series or similar bracket and a third-party, external, stand adapter for pole mounting, such as the K&M™ 195/8 or Ultimate Support™ BMB-200K. Standard colors are black and white. Other colors can be specified as a special order items.

The diverse applications for the JF80z include: band PA, multimedia systems, retail spaces, presentation suites, shopping malls, smaller houses of worship, theatres, auditoriums, lecture halls, and theme parks. Fill/delay applications include arenas, stadiums, concert halls, theatres, and houses of worship.

Six year warranty.

**2-WAY FULL-RANGE**

See *NOTES TABULAR DATA* for details

**CONFIGURATION**

Subsystem		
	<i>Transducer</i>	<i>Loading</i>
LF	2x 6.5 in cone	Sealed
HF	1x 1 in exit, 1.75 in voice coil compression driver	Waveguide Plate™

Operating Mode		
	<i>Amplifier Channels</i>	<i>External Signal Processing</i>
Single-amp	LF/HF	HPF

**PERFORMANCE <sup>1</sup>**

<b>Operating Range</b>	85 Hz to 20 kHz
------------------------	-----------------

<b>Nominal Beamwidth</b> ( <i>rotatable</i> )	
Horz	100°
Vert	100°

<b>Axial Sensitivity</b> ( <i>whole space SPL</i> )		
LF/HF	90 dB	85 Hz to 20 kHz

<b>Input Impedance</b> ( <i>ohms</i> )		
	<i>Nominal</i>	<i>Minimum</i>
LF/HF	8	8.3 @ 240 Hz

<b>Input Taps</b> ( <i>MT version</i> )		
	<b>70 V</b>	<b>100 V</b>
LF/HF	64 W / 32 W / 16 W	64 W / 32 W

<b>High Pass Filter</b>		
High Pass	=>70 Hz, 12 dB/octave Butterworth	

<b>Accelerated Life Test <sup>2</sup></b>		
LF/HF	60 V	450 W @ 8 ohm

<b>Calculated Axial Output Limit</b> ( <i>whole space SPL</i> )		
	<i>Average</i>	<i>Peak</i>
LF/HF	117 dB	123 dB

**ORDERING DATA**

<i>Description</i>	<i>Part Number</i>
JF80z 2-Way Full-Range Loudspeaker Black	0012619
JF80z 2-Way Full-Range Loudspeaker White	0013772
JF80zMT Multi-tap 70/100 V Transformer Black	0013771
JF80z-16 16 ohm Black	0014045
JF80zPL-WP Weather Protected Black	0014360

<b>Optional Accessories</b>	
Eyebolt/Forged Shoulder (1/4-20 x 1 in)	104009
U-Bracket Black	0012345
U-Bracket White	0012348
Yoke Bracket Black	0012395
Yoke Bracket White	0012396

<sup>1</sup> To achieve specified performance, the listed external signal processing with EAW-provided settings is required.

<sup>2</sup> For recommendations to select power amplifier size refer to: "HOW MUCH AMPLIFIER POWER DO I NEED?" on the EAW web site.

## ENCLOSURE

Material	Baltic birch plywood (Celtec® for JF80zPL-WP)
Finish	Wear resistant textured black paint
Grille	Powder-coated perforated steel with foam backing

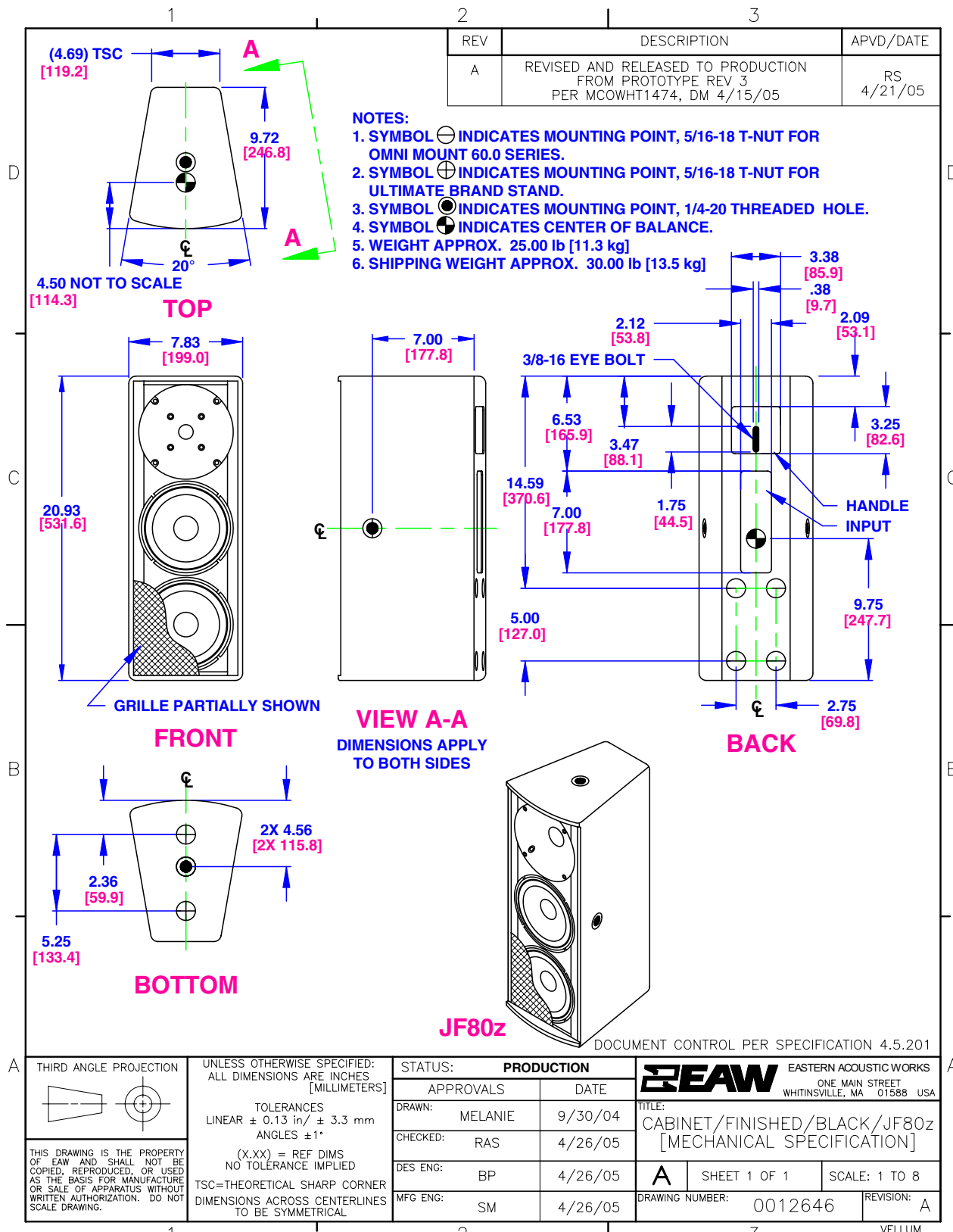

**NOTE:** This drawing has been reduced. Do not scale.  
 For WP version, add 0.25 in / 6.4 mm to the outside dimensions = 0.125 in / 3.2 mm all around.

**PERFORMANCE DATA**

See *NOTES GRAPHIC DATA* for details

**Frequency Response: Processed with HPF**

LF/HF = blue

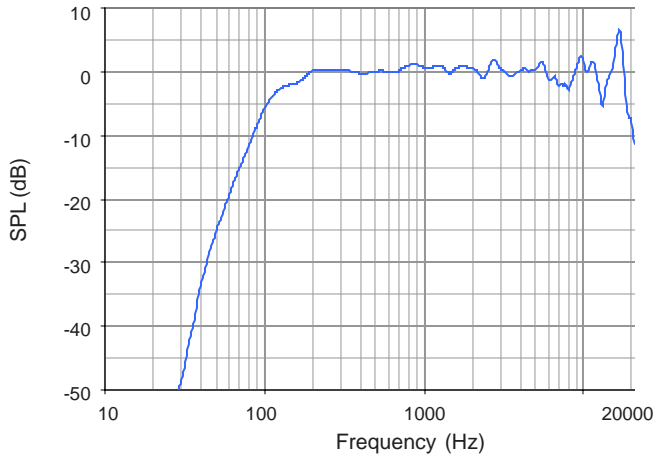

**Frequency Response: Unprocessed**

LF/HF = blue

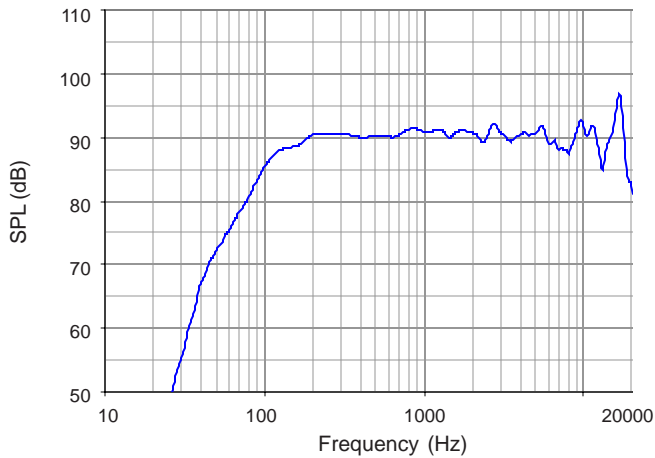

**Frequency Response: Recommended High Pass Filter**

LF/HF = blue

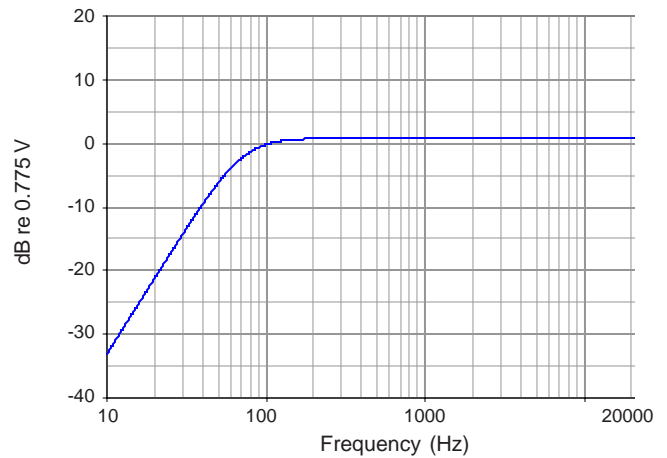

**Impedance Magnitude**

LF/HF = blue

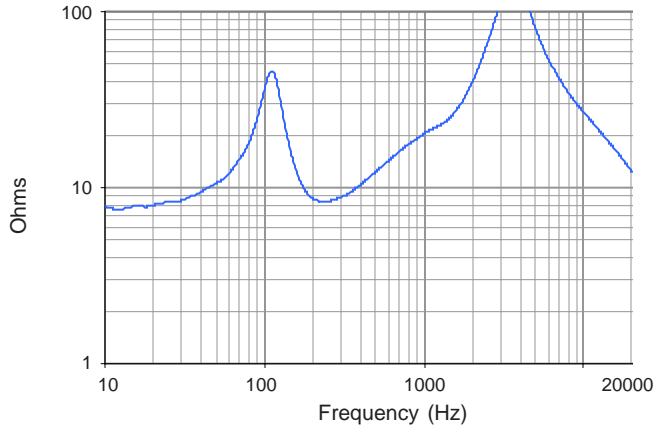

**Beamwidth (-6 dB SPL Points)**

Horizontal = orange Vertical = black

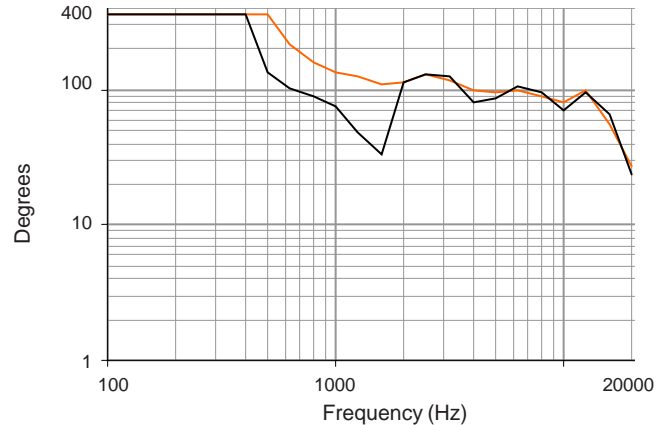

## HORIZONTAL POLAR DATA (Gridlines: 6 dB axial / 15 degree radial)

See **NOTES GRAPHIC DATA** for details

100 Hz  
125 Hz  
160 Hz  
200 Hz

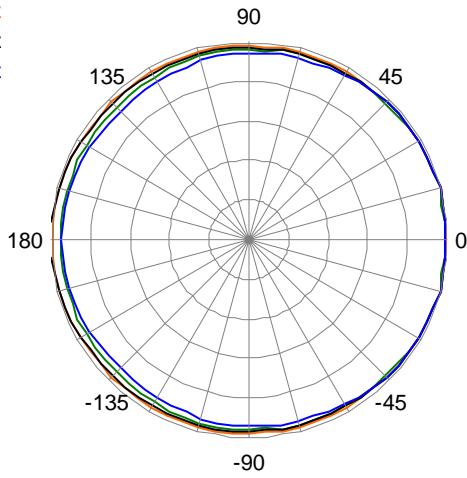

1600 Hz  
2000 Hz  
2500 Hz  
3150 Hz

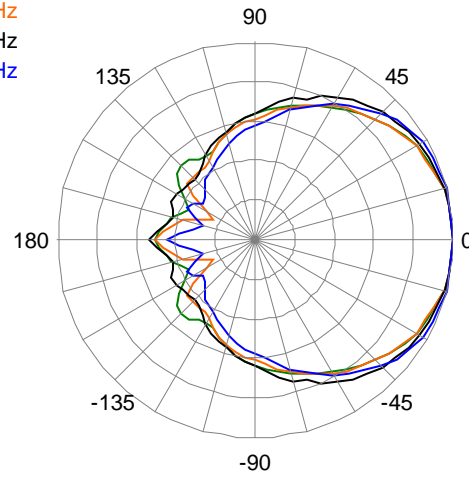

250 Hz  
315 Hz  
400 Hz  
500 Hz

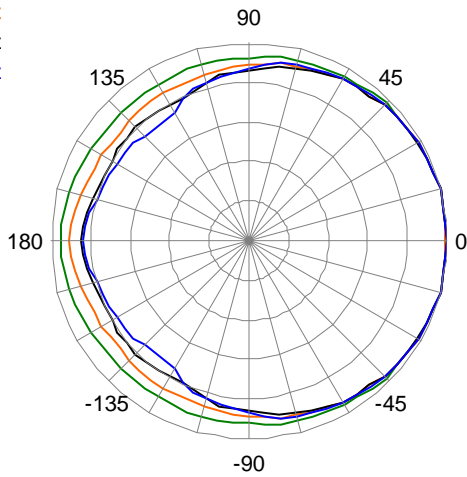

4000 Hz  
5000 Hz  
6300 Hz  
8000 Hz

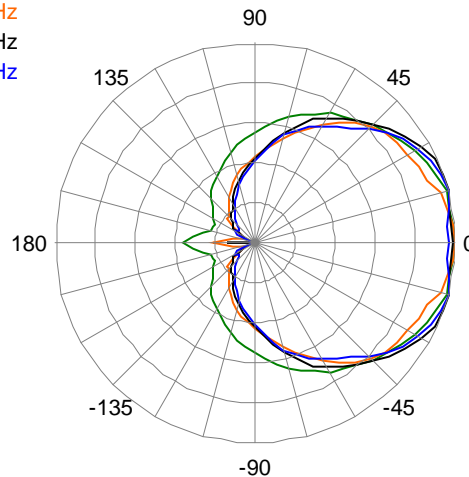

630 Hz  
800 Hz  
1000 Hz  
1250 Hz

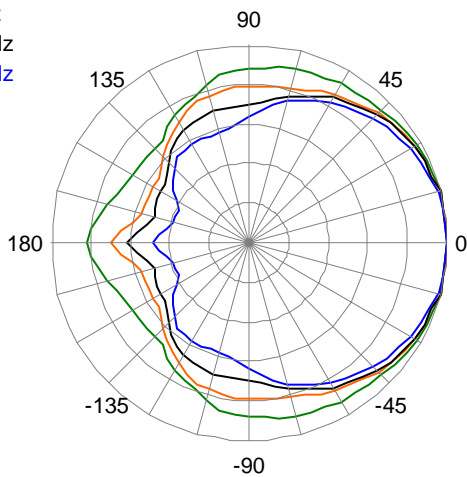

10000 Hz  
12000 Hz  
16000 Hz

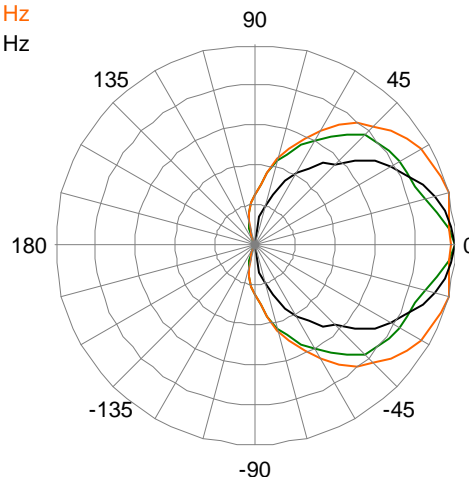

## VERTICAL POLAR DATA (Gridlines: 6 dB axial / 15 degree radial)

See **NOTES GRAPHIC DATA** for details

100 Hz  
125 Hz  
160 Hz  
200 Hz

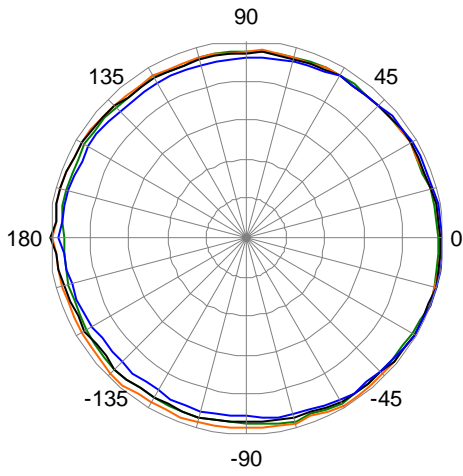

1600 Hz  
2000 Hz  
2500 Hz  
3150 Hz

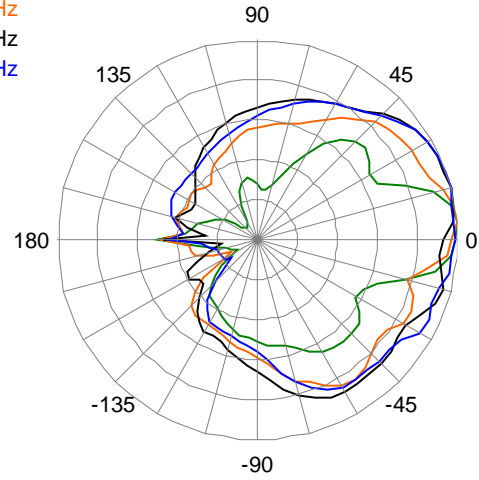

250 Hz  
315 Hz  
400 Hz  
500 Hz

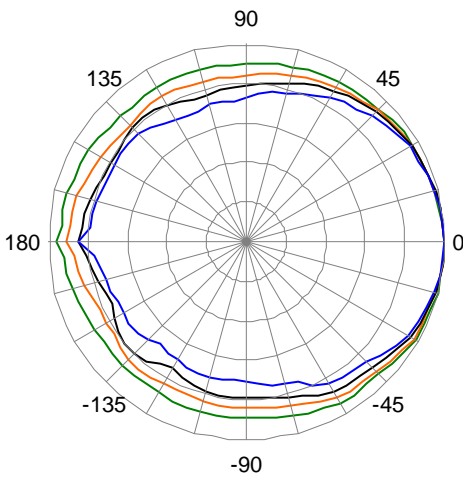

4000 Hz  
5000 Hz  
6300 Hz  
8000 Hz

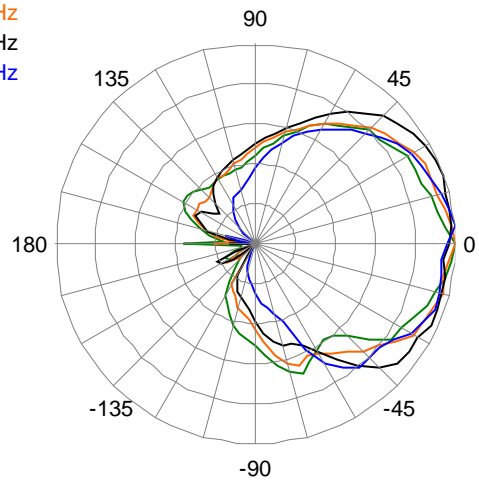

630 Hz  
800 Hz  
1000 Hz  
1250 Hz

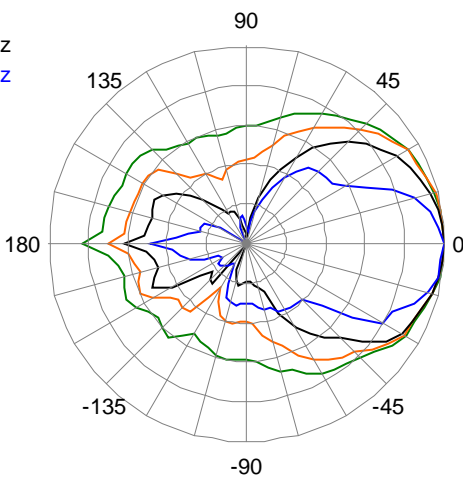

10000 Hz  
12000 Hz  
16000 Hz

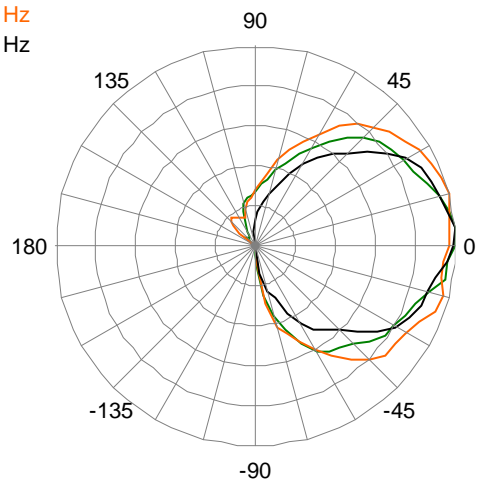

## INPUT PANEL

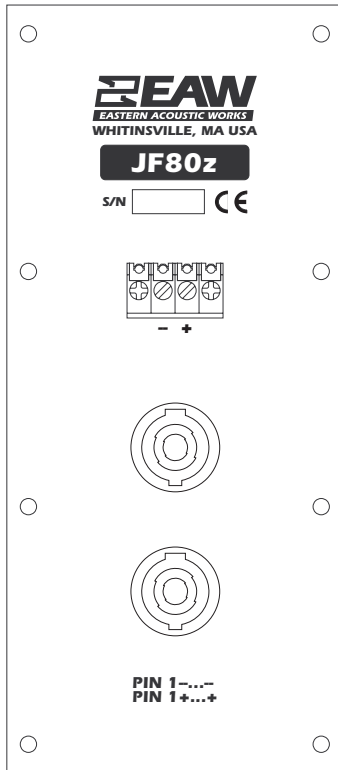

MT version input drawing unavailable

## SIGNAL DIAGRAM

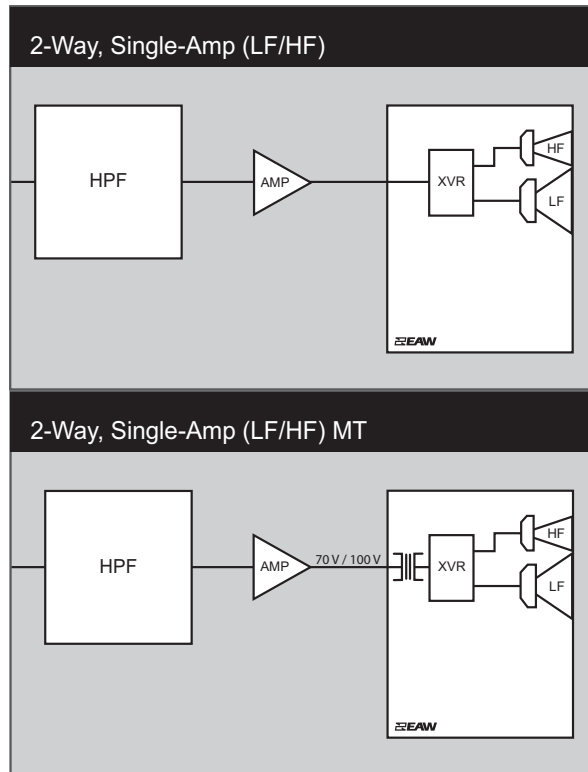

## LEGEND

- DSP:** User-supplied Digital Signal Processor.
- HPF:** High Pass Filter for crossover or Recommended High Pass Filter.
- LPF:** Low Pass Filter for crossover.
- LF/MF/HF:** Low Frequency / Mid Frequency / High Frequency.
- AMP:** User-supplied Power Amplifier.
- XVR:** Passive LPFs, HPFs, and EQ integral to the loudspeaker.

## NOTES

### TABULAR DATA

1. **Measurement/Data Processing Systems:** Primary - FChart: proprietary EAW software; Secondary - Brüel & Kjær 2012.
2. **Microphone Systems:** Earthworks M30; Brüel & Kjær 4133
3. **Measurements:** Dual channel FFT; length: 32 768 samples; sample rate: 48 kHz; logarithmic sine wave sweep.
4. **Measurement System Qualification** (includes all uncertainties): SPL: accuracy +/-0.2 dB @ 1 kHz, precision +/-0.5 dB 20 Hz to 20 kHz, resolution 0.05 dB; Frequency: accuracy +/-1 %, precision +/-0.1 Hz, resolution the larger of 1.5 Hz or 1/48 octave; Time: accuracy +/-10.4 µs, precision +/-0.5 µs, resolution 10.4 µs; Angular: accuracy +/-1°, precision +/-0.5°, resolution 0.5°.
5. **Environment:** Measurements time-widowed and processed to eliminate room effects, approximating an anechoic environment. Data processed as anechoic or fractional space, as noted.
6. **Measurement Distance:** 7.46 m. Acoustic responses represent complex summation of the subsystems at 20 m. SPL is referenced to other distances using the Inverse Square Law.
7. **Volts:** Measured rms value of the test signal.
8. **Watts:** Per audio industry practice, "loudspeaker watts" are calculated as voltage squared divided by rated nominal impedance. Thus, these are not True Watt units of energy as defined by International Standard.
9. **SPL:** (Sound Pressure Level) Equivalent to the average level of a signal referenced to 0 dB SPL = 20 microPascals.
10. **Subsystem:** This lists the transducer(s) and their acoustic loading for each passband. Sub = Subwoofer, LF = Low Frequency, MF = Mid Frequency, HF = High Frequency.
11. **Operating Mode:** User selectable configurations. Between system elements, a comma (,) = separate amplifier channels; a slash (/) = single amplifier channel. DSP = Digital Signal Processor. IMPORTANT: To achieve the specified performance, the listed external signal processing must be used with EAW-provided settings.
12. **Operating Range:** Range where the processed Frequency Response stays within -10 dB SPL of the power averaged SPL within this range; measured on the geometric axis. Narrow band dips are excepted.
13. **Nominal Beamwidth:** Design angle for the -6 dB SPL points, referenced to 0 dB SPL as the highest level.
14. **Axial Sensitivity:** Power averaged SPL over the Operating Range with an input voltage that would produce 1 W at the nominal impedance; measured with no external processing on the geometric axis, referenced to 1 m.
15. **Nominal Impedance:** Selected 4, 8, or 16 ohm resistance such that the minimum impedance point is no more than 20% below this resistance over the Operating Range.
16. **Accelerated Life Test:** Maximum test input voltage applied with an EIA-426B defined spectrum; measured with recommended signal processing and Recommended Protection Filter.
17. **Calculated Axial Output Limit:** Highest average and peak SPLs possible during the Accelerated Life Test. The Peak SPL represents the 2:1 (6 dB) crest factor of the Life Test signal.
18. **High Pass Filter:** This helps protect the loudspeaker from excessive input signal levels at frequencies below the Operating Range.

### GRAPHIC DATA

1. **Resolution:** To remove insignificant fine details, 1/12 octave cepstral smoothing was applied to acoustic frequency responses and 1/3 octave cepstral smoothing was applied to the beamwidth and impedance data. Other graphs are plotted using raw data.
2. **Frequency Responses:** Variation in acoustic output level with frequency for a constant input signal. Processed: normalized to 0 dB SPL. Unprocessed inputs: 2 V (4 ohm nominal impedance), 2.83 V (8 ohm nominal impedance), or 4 V (16 ohm nominal impedance) referenced to a distance of 1 m.
3. **Processor Response:** The variation in output level with frequency for a constant input signal of 0.775 V = 0 dB reference.
4. **Beamwidth:** Average angle for each 1/3 octave frequency band where, starting from the rear of the loudspeaker, the output first reaches -6 dB SPL referenced to 0 dB SPL as the highest level. This method means the output may drop below -6 dB SPL within the beamwidth angle.
5. **Impedance:** Variation in impedance magnitude, in ohms, with frequency without regard to voltage/current phase. This means the impedance values may not be used to calculate True Watts (see 9 above).
6. **Polar Data:** Horizontal and vertical polar responses for each 1/3 octave frequency band 100 Hz to 16 kHz or Operating Range.

## Free Manuals Download Website

<http://myh66.com>

<http://usermanuals.us>

<http://www.somanuals.com>

<http://www.4manuals.cc>

<http://www.manual-lib.com>

<http://www.404manual.com>

<http://www.luxmanual.com>

<http://aubethermostatmanual.com>

Golf course search by state

<http://golfingnear.com>

Email search by domain

<http://emailbydomain.com>

Auto manuals search

<http://auto.somanuals.com>

TV manuals search

<http://tv.somanuals.com>