



**DUAL 18 INCH SUBWOOFER**

See NOTES TABULAR DATA for details, half space = floor-mounted

**CONFIGURATION**

Subsystem		
	Transducer	Loading
SUB	2x 18 in cone	Vented
Operating Mode		
	Amplifier Channels	External Signal Processing
Single-amp	LF1/ LF2	DSP w/1-way filter
Dual-amp	LF1, LF2	DSP w/1-way filter

**PERFORMANCE <sup>1</sup>**

<b>Operating Range</b>	28 Hz to 156 Hz	
<b>Nominal Beamwidth</b>		
Horz	360°	
Vert	360°	

Axial Sensitivity (SPL)		
LF1/LF2 (whole space)	96 dB	28 Hz to 156 Hz
(half space)	102 dB	28 Hz to 156 Hz

Input Impedance (ohms)		
	Nominal	Minimum
LF1/ LF2	4	3.6 @ 33 Hz
LF1, LF2	8 (each)	7.2 @ 33 Hz (each)

High Pass Filter	
High Pass	=>25 Hz, 12 dB/octave Butterworth

Accelerated Life Test <sup>2</sup>		
System	LF1/LF2 75 V	1400 W @ 4 ohm
	LF1, LF2 75 V (each)	700 W @ 8 ohm (each)
Transducer (AES)	1000 W (each)	

Calculated Axial Output Limit (SPL)		
	Average	Peak
LF1/LF2 (whole space)	127 dB	133 dB
(half space)	133 dB	139 dB

**ORDERING DATA**

Description	Part Number
SB1000zP Dual 18 inch Subwoofer Black	997135
SB1000zP Dual 18 inch Subwoofer White	0011611
SB1000zP Dual 18 inch Subwoofer Black WP	997137
Optional Accessories	
3/8-16 Forged Shoulder Eyebolt	104001

**DESCRIPTION**

The SB products are EAW's premium subwoofers designed for the most demanding professional applications. A broad range of capabilities and sizes provide the designer with selections that can be specifically matched to their application. Top quality drivers, engineered by EAW, provide the highest output and best sonic performance possible for a given form factor. All SB models are direct radiating, with optimally tuned, vented enclosures. SB subwoofers are the choice where the best sonic performance, highest reliability, and most robust physical construction are required.

The legendary SB1000zP is a high output, large-format subwoofer system with proven performance in complementing high efficiency, full-range loudspeakers. It is designed for permanent installation where the fatter-sounding output of dual 18 inch drivers is desired. The SB1000zP's driver mounting maximizes cone area and minimizes frontal area, providing the acoustical performance and physical configuration well suited for creating large subwoofer arrays. Its applications include: large houses of worship, large auditoriums/theaters, f/x reinforcement, and large dance clubs.

The SB1000zP is designed to be used with today's sophisticated digital signal processing to optimize the LF response. EAW's MX Series processors are recommended for the required crossover and equalization.

Six Year Warranty.

<sup>1</sup> To achieve specified performance, the listed external signal processing with EAW-provided settings is required.

<sup>2</sup> For recommendations to select power amplifier size refer to: "HOW MUCH AMPLIFIER POWER DO I NEED?" on the EAW web site.

## ENCLOSURE

Material	Baltic birch plywood
Finish	Wear resistant textured black paint
Grille	Powder-coated perforated steel

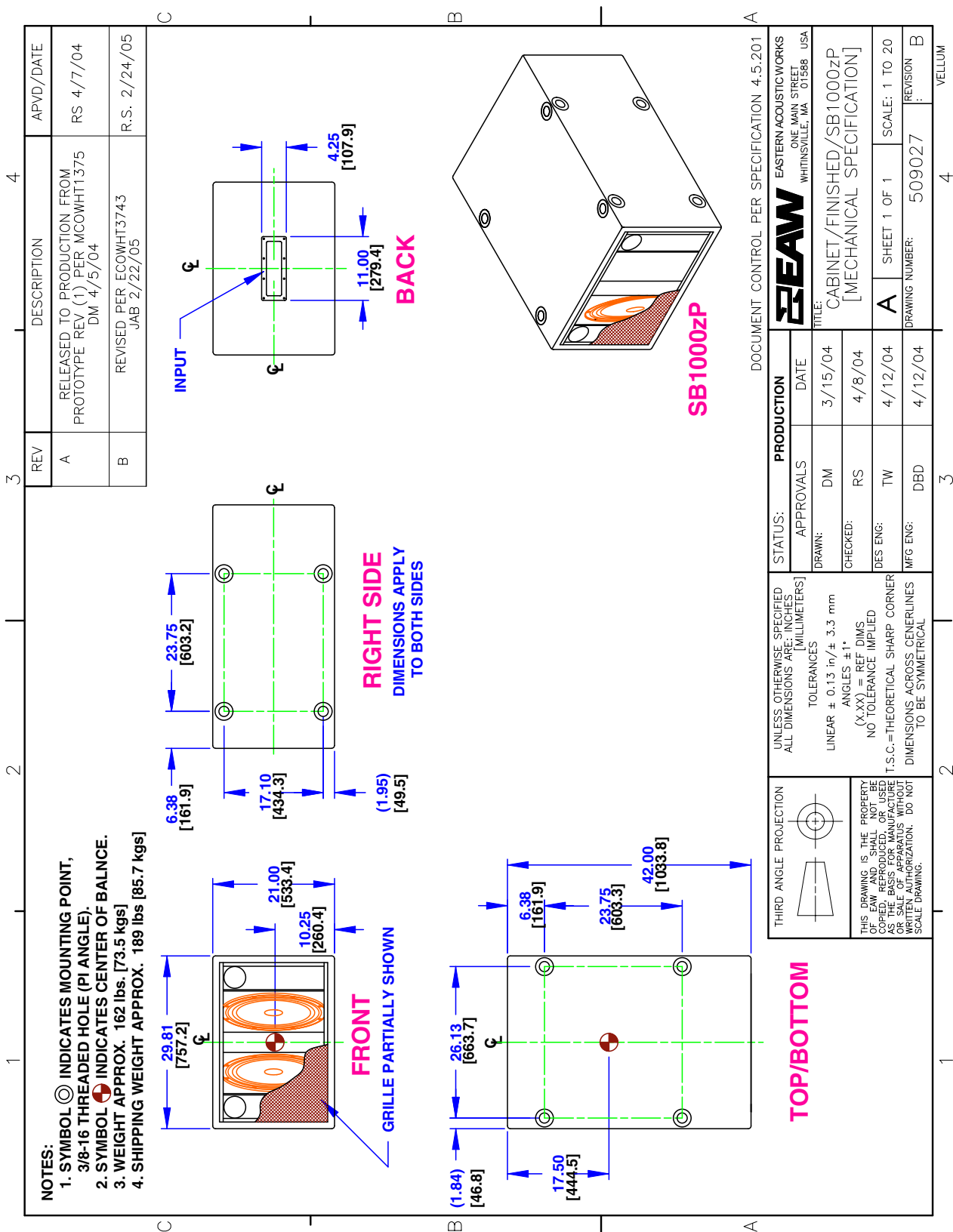

**NOTES:** This drawing has been reduced. Do not scale.  
For WP version, add 0.25 in / 6.4 mm to the outside dimensions = 0.125 in / 3.2 mm all around.

**PERFORMANCE DATA**

See **NOTES GRAPHIC DATA** for details

**Frequency Response: Processed**

LF1/2 Whole Space = green

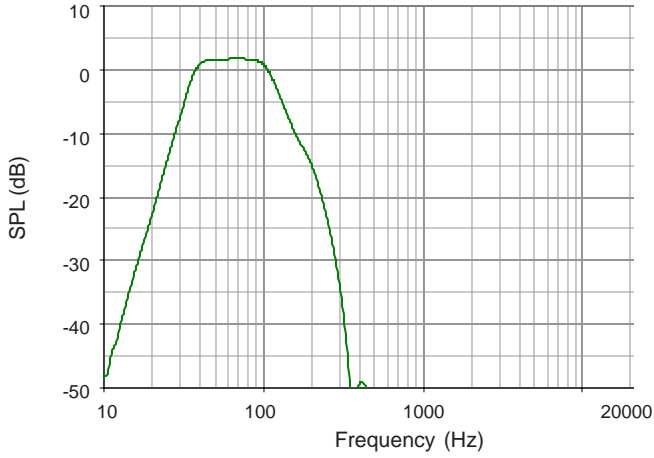

**Frequency Response: Unprocessed**

LF1/2 Whole Space = green

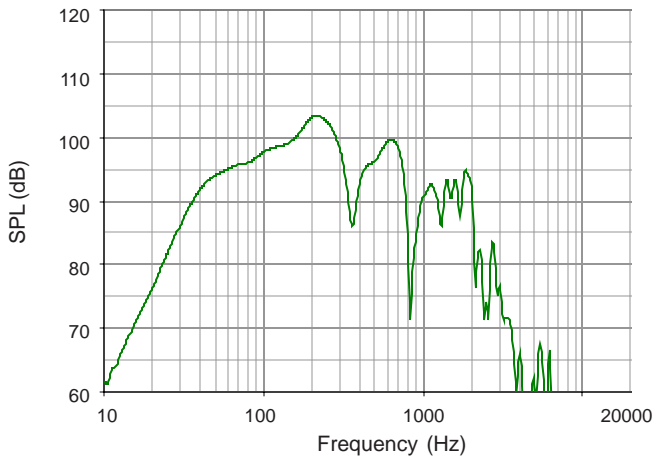

**Frequency Response: Digital Signal Processor**

LF = green

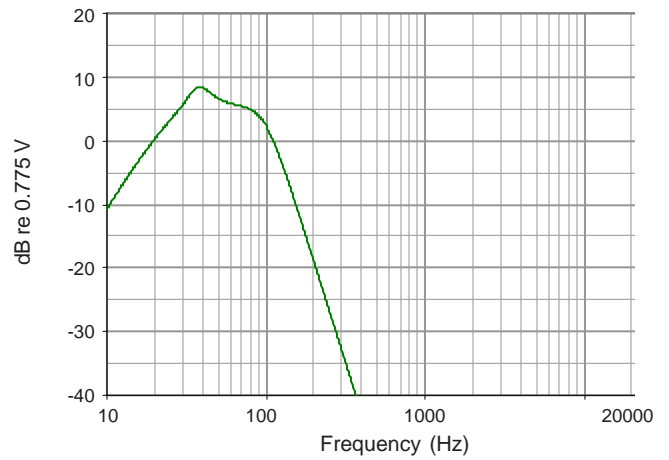

**Impedance Magnitude**

LF1/2 = green LF1, LF 2 (each) = orange

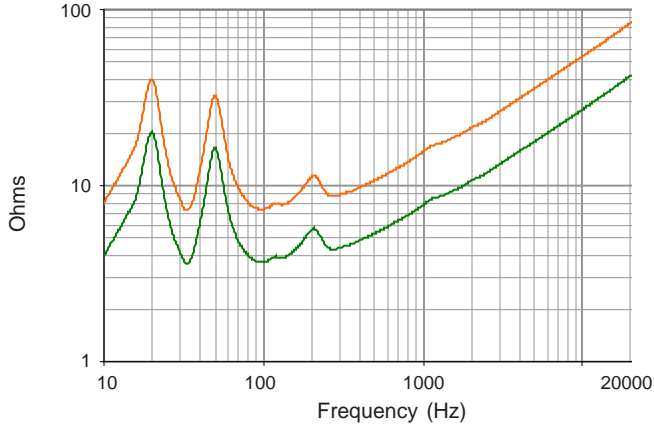

## INPUT PANEL

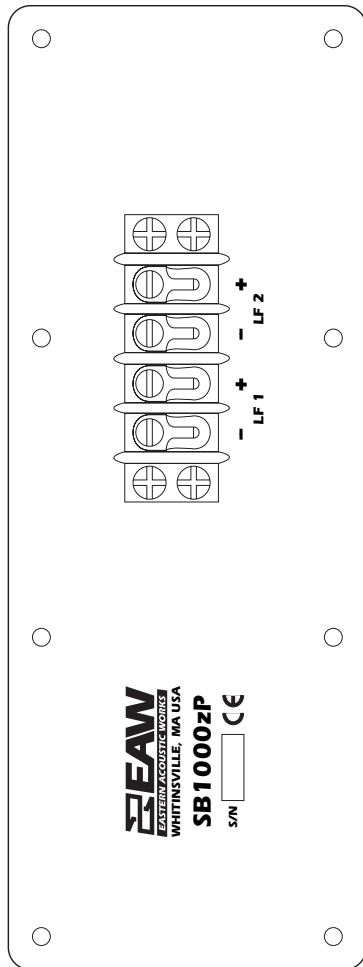

## SIGNAL DIAGRAM

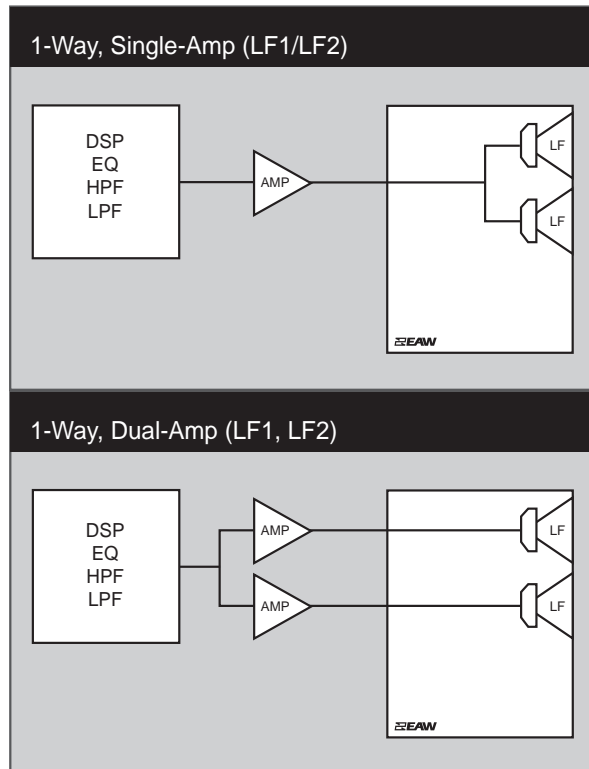

## LEGEND

- DSP:** User-supplied Digital Signal Processor.
- HPF:** High Pass Filter for crossover or specified High Pass Filter.
- LPF:** Low Pass Filter for crossover.
- LF/MF/HF:** Low Frequency / Mid Frequency / High Frequency.
- AMP:** User-supplied Power Amplifier.
- XVR:** Passive LPFs, HPFs, and EQ integral to the loudspeaker.

## NOTES

### TABULAR DATA

1. **Measurement/Data Processing Systems:** Primary - FChart: proprietary EAW software; Secondary - Brüel & Kjær 2012.
2. **Microphone Systems:** Earthworks M30; Brüel & Kjær 4133
3. **Measurements:** Dual channel FFT; length: 32 768 samples; sample rate: 48 kHz; logarithmic sine wave sweep.
4. **Measurement System Qualification** (includes all uncertainties): SPL: accuracy +/-0.2 dB @ 1 kHz, precision +/-0.5 dB 20 Hz to 20 kHz, resolution 0.05 dB; Frequency: accuracy +/-1 %, precision +/-0.1 Hz, resolution the larger of 1.5 Hz or 1/48 octave; Time: accuracy +/-10.4 µs, precision +/-0.5 µs, resolution 10.4 µs; Angular: accuracy +/-1°, precision +/-0.5°, resolution 0.5°.
5. **Environment:** Measurements time-widowed and processed to eliminate room effects, approximating an anechoic environment. Data processed as anechoic or fractional space, as noted.
6. **Measurement Distance:** 7.46 m. Acoustic responses represent complex summation of the subsystems at 20 m. SPL is referenced to other distances using the Inverse Square Law.
7. **Volts:** Measured rms value of the test signal.
8. **Watts:** Per audio industry practice, "loudspeaker watts" are calculated as voltage squared divided by rated nominal impedance. Thus, these are not True Watt units of energy as defined by International Standard.
9. **SPL:** (Sound Pressure Level) Equivalent to the average level of a signal referenced to 0 dB SPL = 20 microPascals.
10. **Subsystem:** This lists the transducer(s) and their acoustic loading for each passband. Sub = Subwoofer, LF = Low Frequency, MF = Mid Frequency, HF = High Frequency.
11. **Operating Mode:** User selectable configurations. Between system elements, a comma (,) = separate amplifier channels; a slash (/) = single amplifier channel. DSP = Digital Signal Processor. IMPORTANT: To achieve the specified performance, the listed external signal processing must be used with EAW-provided settings.
12. **Operating Range:** Range where the processed Frequency Response stays within -10 dB SPL of the power averaged SPL within this range; measured on the geometric axis. Narrow band dips are excepted.
13. **Nominal Beamwidth:** Design angle for the -6 dB SPL points, referenced to 0 dB SPL as the highest level.
14. **Axial Sensitivity:** Power averaged SPL over the Operating Range with an input voltage that would produce 1 W at the nominal impedance; measured with no external processing on the geometric axis, referenced to 1 m.
15. **Nominal Impedance:** Selected 4, 8, or 16 ohm resistance such that the minimum impedance point is no more than 20% below this resistance over the Operating Range.
16. **High Pass Filter:** This helps protect the loudspeaker from excessive input signal levels at frequencies below the Operating Range.
17. **Accelerated Life Test:** System: Maximum test input voltage applied with an EIA-426B defined spectrum; measured with specified signal processing; Transducer: AES2-1984 R 1997.
18. **Calculated Axial Output Limit:** Highest average and peak SPLs possible during the Accelerated Life Test. The Peak SPL represents the 2:1 (6 dB) crest factor of the Life Test signal.

### GRAPHIC DATA

1. **Resolution:** To remove insignificant fine details, 1/12 octave cepstral smoothing was applied to acoustic frequency responses and 1/3 octave cepstral smoothing was applied to the beamwidth and impedance data. Other graphs are plotted using raw data.
2. **Frequency Responses:** Variation in acoustic output level with frequency for a constant input signal. Processed: normalized to 0 dB SPL. Unprocessed inputs: 2 V (4 ohm nominal impedance), 2.83 V (8 ohm nominal impedance), or 4 V (16 ohm nominal impedance) referenced to a distance of 1 m.
3. **Processor Response:** The variation in output level with frequency for a constant input signal of 0.775 V = 0 dB reference.
4. **Impedance:** Variation in impedance magnitude, in ohms, with frequency without regard to voltage/current phase. This means the impedance values may not be used to calculate True Watts (see 8 above).

## Free Manuals Download Website

<http://myh66.com>

<http://usermanuals.us>

<http://www.somanuals.com>

<http://www.4manuals.cc>

<http://www.manual-lib.com>

<http://www.404manual.com>

<http://www.luxmanual.com>

<http://aubethermostatmanual.com>

Golf course search by state

<http://golfingnear.com>

Email search by domain

<http://emailbydomain.com>

Auto manuals search

<http://auto.somanuals.com>

TV manuals search

<http://tv.somanuals.com>