



www.eaglesonar.com

Pub. 988-0156-031



Fish Mark^{500c} SeaFinder^{500c DF}

Fish-Finding & Depth-Sounding Sonars

Installation and Operation Instructions

Copyright © 2004 LEI-Eagle
All rights reserved.

Eagle® is a registered trademark of LEI
FishMark® and SeaFinder® are registered trademarks of LEI

Eagle Electronics may find it necessary to change or end our policies, regulations, and special offers at any time. We reserve the right to do so without notice. All features and specifications subject to change without notice. All screens in this manual are simulated. On the cover: SeaFinder® 500CDF shown. Other models covered in the manual are similar.

No part of this manual may be copied, reproduced, republished, transmitted or distributed for any purpose, without prior written consent of Eagle Electronics. **Any unauthorized commercial distribution of this manual is strictly prohibited.**

**For free owner's manuals and the most current information on
this product, its operation and accessories,
visit our web site:
www.eaglesonar.com**

Eagle Electronics
P.O. Box 669
Catoosa, OK USA 74015
Printed in USA.

Table of Contents

Section 1: Read Me First!	1
Capabilities and Specifications	2
How Sonar Works	4
How to Use this Manual: Typographical Conventions.....	5
Section 2: Installation & Accessories	7
Preparations.....	7
Transducer Installation.....	7
Recommended Tools and Supplies	8
Selecting a Transducer Location.....	9
How low should you go?.....	10
Shoot-Thru-Hull vs. Transom Mounting	11
Transom Transducer Assembly and Mounting	12
Trolling Motor Bracket Installation (single-frequency only).....	19
Transducer Orientation and Fish Arches.....	20
Shoot-Thru-Hull Preparation.....	22
Testing Determines Best Location.....	23
Shoot-Thru-Hull Installation	24
Speed/Temperature Sensors.....	26
Optional Speed Sensor Installation	27
Power Connections.....	29
Mounting the Unit: Bracket, In-Dash or Portable	31
Face Cover.....	35
Basic Sonar Operation	37
Keyboard	37
Power/lights on and off	38
Main Menu	39
Pages	40
Basic Sonar Quick Reference	45
Sonar Operations	46
Fish Symbols vs. Full Sonar Chart.....	50
Other Free Training Aids	50
Section 4: Sonar Options & Other Features	53

ASP™ (Advanced Signal Processing).....	53
Alarms	54
Depth Alarms	55
Zone Alarm	56
Fish Alarm.....	57
Backlight Level	58
Calibrate Speed.....	59
Chart Speed.....	60
ColorLine™.....	61
ColorLine level:	61
Contrast.....	63
Depth Cursor.....	63
Depth Range - Automatic	64
Depth Range - Manual	64
FasTrack™	65
Fish I.D.™ (Fish Symbols & Depths).....	66
FishTrack™	67
Frequency (Change Transducer Frequency) (SeaFinder CDF only).....	68
To change the frequency setting to 50 kHz:	69
To change the frequency setting to 200 kHz:	70
HyperScroll™	70
Noise Rejection.....	70
Overlay Data	70
Ping Speed & HyperScroll™	73
To change Ping Speed:.....	75
To adjust Sensitivity:.....	75
To turn off HyperScroll:.....	75
Pop-up Help.....	75
Reset Options	76
Reset Water Distance	77
Set Keel Offset	77
Sensitivity & Auto Sensitivity.....	79
Automatic Sensitivity	79

To turn Auto Sensitivity back on:	81
Set Language	81
Software Version Information	81
Sonar Chart Mode.....	82
Sonar Page & Sonar Chart Display Options	82
Full Sonar Chart	83
Split Zoom Sonar Chart.....	84
Digital Data/Chart	84
Sonar Simulator	86
Stop Chart	87
Surface Clarity	88
Transparency	90
Units of Measure.....	90
Zoom & Zoom Bar	91
Zoom Pan.....	92
Section 5: Troubleshooting	93
Section 6: Supplemental Material	97

Notes

Section 1: Read Me First!

How this manual can get you out on the water, fast!

Welcome to the exciting world of digital sonar! We know you're anxious to begin finding fish, but we have a favor to ask. Before you grab your unit and begin installing it, please give us a moment or two to explain how our manual can help you get the best performance from your compact, wide-screen, fish finder.

First, we want to thank you for buying an Eagle sonar. Whether you're a first time user or a professional fisherman, you'll discover that your unit is easy to use, yet capable of handling demanding sonar tasks. You won't find another sonar unit with this much power and this many features for this price!

Our goal for this book is to get you on the water fast, with a minimum of fuss. Like you, we'd rather spend more time boating or fishing and less time reading the manual!

So, we designed our book so that you *don't* have to read the *whole thing* from front to back for the information you want. At the start (or end) of each segment, we'll tell you what content is coming up next. If it's a concept you're already familiar with, we'll show you how and where to skip ahead for the next important topic. We've also made it easy to look up any tips you may need from time to time. Here's how:

The manual is organized into 6 sections. This first section is an introduction to the sonar unit. It tells you the basics you need to know before you can make the unit look below the surface to find some fish.

Section 2 will help you install your unit and the transducer. We'll also tell you about some of the available accessories.

Section 3 covers *Basic Sonar Operation*. It will show you how easy it is to run your sonar, right out of the box. This section features a one-page Sonar Quick Reference. **(If you've already jumped ahead and figured out how to install the unit yourself, and you just *can't* wait**

any longer, turn to the **Quick Reference on page 45 and head for the water with your sonar unit!**

After you've gained some experience with your sonar, you'll want to check out Section 4, which discusses more advanced *Sonar Options and Other Features*.

When you come to a sonar menu command on the unit's screen, you can look it up in the manual by skimming over the table of contents, just flipping through Section 3 or scanning through the sonar options in Section 4.

If you're having difficulty with your sonar, you can find an answer to the most common problems in Section 5, *Sonar Troubleshooting*.

Finally, in Section 6, we offer *Supplemental Material*, including a list of warranty and customer service information.

Now, if you're into the fine details, glance over the next segment on specifications to see just how much sonar power your unit contains. It's important to *us* (and our power users), but, if *you* don't care how many watts of power the unit has, skip ahead to important information on how sonar works, on page 4.

Capabilities and Specifications: FishMark® 500C, SeaFinder® 500CDF

General

- Display:**..... 5.0" (12.7 cm) diagonal color TFT LCD; programmable to viewing preference.
- Resolution:**..... 320 pixel x 240 pixel resolution; 76,800 total pixels.
- Backlighting:**..... Backlit screen and keypad with multiple lighting levels for night use.
- Input power:**..... 10 to 15 volts DC.
- Case size:**..... 5.4" H x 6.9" W x 3.4" D (13.8 x 17.6 x 8.6 cm); sealed and waterproof; suitable for saltwater use.

Back-up memory: Built-in memory stores sonar records for decades.

Languages:..... 10; menu languages selectable by user.

Sonar

Frequency:..... 50/200 kHz for SeaFinder 500CDF; 200 kHz for FishMark 500C.

Transducers: A dual-frequency Skimmer® transducer with built-in temperature sensor is packed with the SeaFinder 500CDF. It has 35°/12° cone angles. A single-frequency Skimmer transducer with built-in temperature sensor is packed with the FishMark 500C. It has a 20° cone angle. Transducers operate at speeds up to 70 mph (61 kts)

Watts: 1,500 watts peak-to-peak/188 watt RMS.

Sonar sounding

depth capability: **SeaFinder 500CDF:** 1,500 feet (450 meters). **FishMark 500C:** 800 feet (244 meters).

Actual capability depends on transducer configuration and installation, bottom composition and water conditions. All sonar units typically read deeper in fresh water than in salt water.

Depth display:..... Continuous display .

Audible alarms: Deep/shallow/fish/zone.

Automatic ranging:..... Yes, with instant screen updates.

Auto bottom track:..... Yes.

Zoom bottom track: Yes.

Split-screen zoom:..... Yes.

Surface water temp: Yes.

Speed/distance log: Optional (requires optional speed sensor).

NOTICE!

The storage temperature range for your unit is from -4 degrees to +167 degrees Fahrenheit (-20 degrees to +75 degrees Celsius). *Extended storage in temperatures higher or lower than specified will damage the liquid crystal display in your unit. This type of damage is not covered by the warranty.* For more information, contact the factory's Customer Service Department; phone numbers are listed on the last page.

How Sonar Works

Sonar has been around since the 1940s, so if you already know how it works, skip ahead to the next segment on the typographical conventions used in this manual. But, if you've never owned a sonar fish finder, this segment will tell you the under water basics.

Sonar is an abbreviation for Sound Navigation and Ranging, a technology developed during World War II for tracking enemy submarines. A sonar consists of a transmitter, transducer, receiver and display. In simple terms, here's how it finds the bottom, or the fish:

The transmitter emits an electrical impulse, which the transducer converts into a sound wave and sends into the water. (The sound frequency can't be heard by humans or fish.) The sound wave strikes an object (fish, structure, bottom) and bounces back to the transducer, which converts the sound back into an electrical signal.

The receiver amplifies this return signal, or echo, and sends it to the display, where an image of the object appears on the scrolling sonar chart. The sonar's microprocessor calculates the time lapse between the transmitted signal and echo return to determine the distance to the object. The whole process repeats itself several times each second.

How to Use this Manual: Typographical Conventions

Many instructions are listed as numbered steps. The keypad and arrow "keystrokes" appear as boldface type. So, if you're in a real hurry (or just need a reminder), you can skim the instructions and pick out what menu command to use by finding the boldface command text. The following paragraphs explain how to interpret the text formatting for those commands and other instructions:

Arrow Keys

The arrow keys control a horizontal line depth cursor on the sonar screen. The arrow keys also help you move around the menus so you can execute different commands. They are represented by symbols like these, which denote the down arrow key, the up arrow, the left arrow and the right arrow: ↓ ↑ ← →.

Keyboard

The other keys perform a variety of functions. When the text refers to a key to press, the key is shown in bold, sans serif type. For example, the "Enter/Icons" key is shown as **ENT** and the "Menu" key is shown as **MENU**.

Menu Commands

A menu command or a menu option will appear in small capital letters, in a bold sans serif type like this: **DEPTH CURSOR**. These indicate that you are to select this command or option from a menu or take an action of some kind with the menu item. Text that you may need to enter or file names you need to select are shown in italic type, such as *data type*.

Instructions = Menu Sequences

Most functions you perform with the sonar unit are described as a sequence of key strokes and selecting menu commands. We've written them in a condensed manner for quick and easy reading.

For example, instructions for turning on the Fish ID™ feature would look like this:

1. From the Sonar Page, press **MENU** | ↓ to **SONAR FEATURES** | **ENT**.
2. Press → or → ↓ to **FISH ID SYMBOLS** | **ENT** | **EXIT** | **EXIT**.

Translated into complete English, step 1 above would mean: "Start on the Sonar Page. Press the Menu key then repeatedly press (or press and hold) the down arrow key to scroll down the menu and select (highlight) the Sonar Features menu command. Then press the Enter key."

Step 2 would mean: "Press the right arrow key (for dual-frequency units) or press the right arrow key followed by the down arrow key (for single-frequency units) to select (highlight) the Fish ID symbols command. Next, press the Enter key, then press the Exit key twice."

Section 2: Installation & Accessories

Preparations

You can install the sonar system in some other order if you prefer, but we recommend this installation sequence:

Caution:

You should read over this entire installation section before drilling any holes in your vessel!

1. Determine the approximate location for the sonar unit, so you can plan how and where to route the cables for the transducer and power. This will help you make sure you have enough cable length for the desired configuration.
2. Determine the approximate location for the transducer and its cable route.
3. Determine the location of your battery or other power connection, along with the power cable route.
4. Install the transducer and route the transducer cable to the sonar unit.
5. Route the power cable from the unit's location to an appropriate power source and connect it there.
6. Connect the transducer/power cable to the unit and mount the sonar unit on the bracket.

Transducer Installation

These instructions will help you install your Skimmer[®] transducer on a transom, on a trolling motor or inside a hull. These instructions cover both single- and dual-frequency Skimmer transducers. Please read all instructions before proceeding with any installation.

Your Skimmer transducer typically comes packaged with a one-piece stainless steel bracket for mounting it to the transom of your boat. The

optional trolling motor mount uses a one-piece plastic bracket with an adjustable strap. These are "kick-up" mounting brackets. They help prevent damage if the transducer strikes an object while the boat is moving. If the transducer does "kick-up," the bracket can easily be pushed back into place without tools.

Read these instructions carefully *before* attempting the installation. Determine which of the installation methods is right for your boat.

Remember, the transducer location and installation is the most critical part of a sonar installation.

Recommended Tools and Supplies

If you prefer the option of routing the cable through the transom, you will need a 5/8" drill bit. (If you intend to install an additional speed or temp sensor and route its cable through the same hole in the transom, you will need a 1" (25.4 mm) drill bit to accommodate all the cables.)

NOTE:

The following installation types also call for these recommended tools and required supplies that you must provide (supplies listed here are *not* included):

Single-frequency transom installations

Tools include: two adjustable wrenches, drill, #29 (0.136") drill bit, flat-head screwdriver. Supplies: none.

Dual-frequency transom installations

Tools: two adjustable wrenches, drill, #20 (0.161") drill bit, flat-head screwdriver. Supplies: four, 1" long, #12 stainless steel slotted wood screws.

Single-frequency trolling motor installations

Tools: two adjustable wrenches, flat-head screwdriver. Supplies: plastic cable ties.

Shoot-through hull installations

Tools: these will vary depending on your hull's composition. Consult your boat dealer or manufacturer. Other tools are a wooden craft stick

or similar tool for stirring and applying epoxy, and a paper plate or piece of cardboard to mix the epoxy on. Supplies: rubbing alcohol, 100 grit sandpaper, specially formulated epoxy adhesive available from LEI (see ordering information on the inside portion of the back cover). A sandwich hull also requires polyester resin.

Selecting a Transducer Location

1. The location must be in the water at all times, at all operating speeds.
2. The transducer must be placed in a location that has a *smooth flow* of water at all times. If the transducer is not placed in a smooth flow of water, interference caused by bubbles and turbulence will show on the sonar's display in the form of random lines or dots whenever the boat is moving.

NOTE:

Some aluminum boats with strakes or ribs on the outside of the hull create large amounts of turbulence at high speed. These boats typically have large outboard motors capable of propelling the boat at speeds faster than 35 mph. Typically, a good transom location on aluminum boats is between the ribs closest to the engine.

3. The transducer should be installed with its face pointing straight down, if possible. *For shoot-thru applications:* Many popular fishing boat hulls have a flat keel pad that offers a good mounting surface. On vee hulls, try to place the transducer where the deadrise is 10° or less.

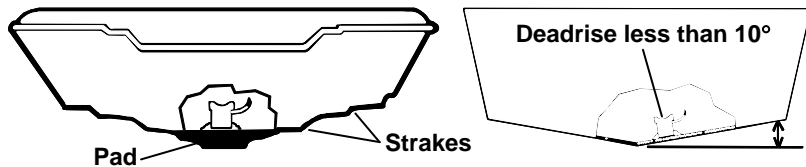

Left, vee pad hull; right, vee hull. A pod style transducer is shown here, but the principle is the same for Skimmers inside a hull.

4. If the transducer is mounted on the transom, make sure it doesn't interfere with the trailer or hauling of the boat. Also, don't mount it

closer than approximately one foot from the engine's lower unit. This will prevent cavitation (bubble) interference with propeller operation.

5. If possible, route the transducer cable away from other wiring on the boat. Electrical noise from engine wiring, bilge pumps and aerators can be displayed on the sonar's screen. Use caution when routing the transducer cable around these wires.

CAUTION: Clamp the transducer cable to transom near the transducer. This will help prevent the transducer from entering the boat if it is knocked off at high speed.

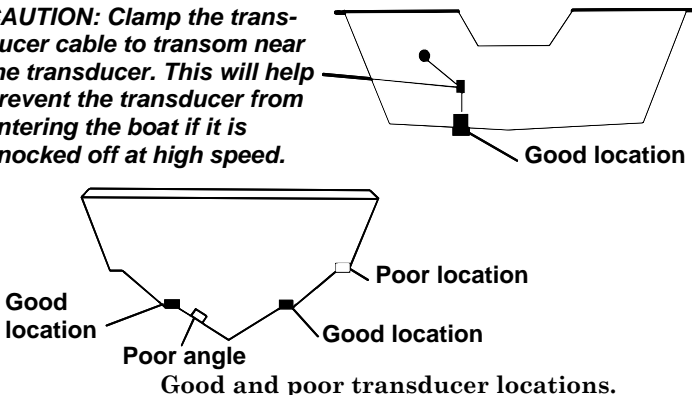

How low should you go?

For most situations, you should install your Skimmer transducer so that its centerline is level with the bottom of the boat hull. This will usually give you the best combination of smooth water flow and protection from bangs and bumps.

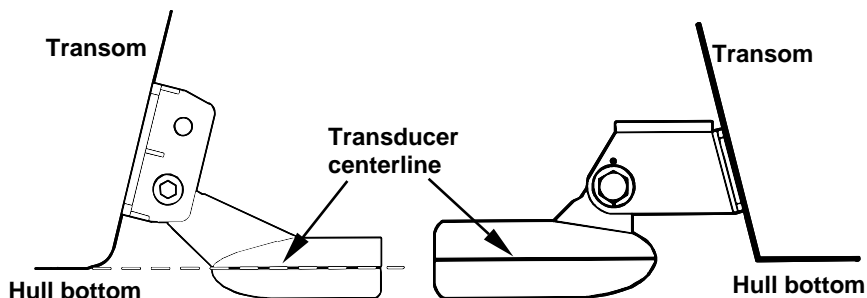

Align transducer centerline with hull bottom. A dual frequency transducer is shown at left and a single frequency transducer at right.

However, there are times when you may need to adjust the transducer slightly higher or lower. (The slots in the mounting brackets allow you to loosen the screws and slide the transducer up or down.) If you frequently lose bottom signal lock while running at high speed, the transducer may be coming out of the water as you cross waves or wakes. Move the transducer a little lower to help prevent this.

If you cruise or fish around lots of structure and cover, your transducer may be frequently kicking up from object strikes. If you wish, you may move the transducer a little higher for more protection.

There are two extremes you should avoid. Never let the edge of the mounting bracket extend below the bottom of the hull. Never let the bottom – the face – of the transducer rise above the bottom of the hull.

Shoot-Thru-Hull vs. Transom Mounting

In a shoot-thru-hull installation, the transducer is bonded to the *inside* of the hull with epoxy. The sonar "ping" signal actually passes through the hull and into the water. This differs from a bolt-thru-hull installation (often called simply "thru-hull"). In that case, a hole is cut in the hull and a specially designed transducer is mounted *through* the hull with a threaded shaft and nut. This puts the transducer in direct contact with the water.

Typically, shoot-thru-hull installations give excellent high speed operation and good to excellent depth capability. There is no possibility of transducer damage from floating objects, as there is with a transom-mounted transducer. A transducer mounted inside the hull can't be knocked off when docking or loading on a trailer.

However, the shoot-thru-hull installation does have its drawbacks. First, some loss of sensitivity does occur, even on the best hulls. This varies from hull to hull, even from different installations on the same hull. This is caused by differences in hull lay-up and construction.

Second, the transducer angle cannot be adjusted for the best fish arches on your sonar display.

Lack of angle adjustment can be particularly troublesome on hulls that sit with the bow high when at rest or at slow trolling speeds.

Third, a transducer **CAN NOT** shoot through wood and metal hulls. Those hulls require either a transom mount or a thru-hull installation.

Fourth, if your Skimmer transducer has a built in temp sensor, it will only show the temperature of the bilge, not the water surface temp.

Follow the testing procedures listed in the shoot-thru-hull installation section at the end of this instruction booklet to determine if you can satisfactorily shoot through the hull.

Transom Transducer Assembly and Mounting

The best way to install these transducers is to loosely assemble all of the parts first, place the transducer's bracket against the transom and see if you can move the transducer so that it's parallel with the ground.

The following instructions sometimes vary depending on the mounting bracket that came with your transducer. Single frequency Skimmers come with a one-piece stainless steel bracket, while dual frequency Skimmers come with a two-piece plastic mounting bracket. Use the set of instructions that fits your model.

1. Assembling the bracket.

A. One-piece bracket: Press the two small plastic ratchets into the sides of the metal bracket as shown in the following illustration. Notice there are letters molded into each ratchet. Place each ratchet into the bracket with the letter "A" aligned with the dot stamped into the metal bracket. This position sets the transducer's coarse angle adjustment for a 14° transom. Most outboard and stern-drive transoms have a 14° angle.

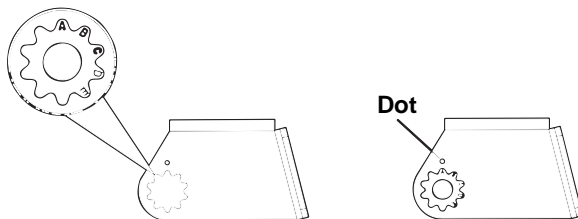

Align plastic ratchets in bracket.

B. Two-piece bracket: Locate the four plastic ratchets in the transducer's hardware package. Press two ratchets into the sides of the plastic bracket and two on either side of the transducer as shown in the following illustrations. Notice there are letters molded into each ratchet. Place the ratchets into the bracket with the letter "A" aligned with the alignment mark molded into the bracket. Place the ratchets onto the transducer with the letter "A" aligned with the 12 o'clock position on the transducer stem. These positions set the transducer's coarse angle adjustment for a 14° transom. Most outboard and stern-drive transoms have a 14° angle.

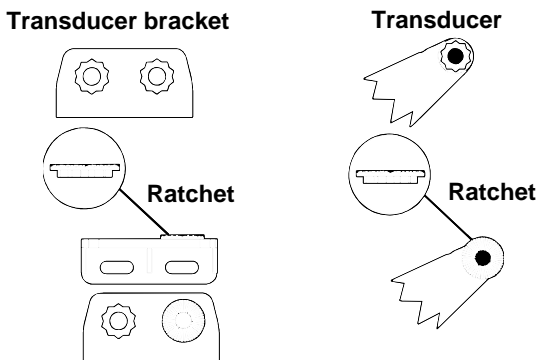
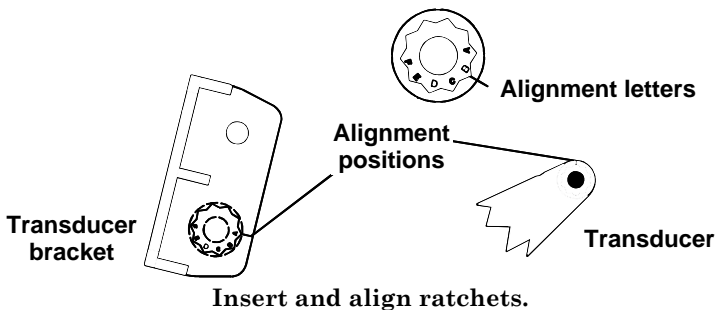

2. Aligning the transducer on the transom.

A. One-piece bracket: Slide the transducer between the two ratchets. Temporarily slide the bolt through the transducer assembly and hold it against the transom. Looking at the transducer from the side, check to see if it will adjust so that its face is parallel to the ground. If it does, then the "A" position is correct for your hull.

If the transducer's face isn't parallel with the ground, remove the transducer and ratchets from the bracket. Place the ratchets into the

holes in the bracket with the letter "B" aligned with the dot stamped in the bracket.

Reassemble the transducer and bracket and place them against the transom. Again, check to see if you can move the transducer so it's parallel with the ground. If you can, then go to step 3A. If it doesn't, repeat step 2A, but use a different alignment letter until you can place the transducer on the transom correctly.

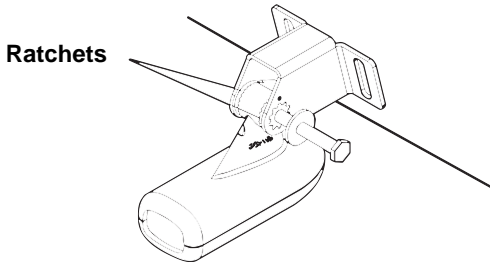

Insert bolt and check transducer position on transom.

B. Two-piece bracket: Assemble the transducer and bracket as shown in the following figure. Temporarily slide the bolt through the transducer assembly but don't tighten the nut at this time. Hold the assembled transducer and bracket against the transom. Looking at the transducer from the side, check to see if it will adjust so that its face is parallel to the ground. If it does, then the "A" positions are correct for your hull.

If the transducer's face isn't parallel with the ground, remove and disassemble the transducer and ratchets. Place the ratchets into the bracket holes with the letter "B" aligned with the bracket alignment mark. Place them on the transducer aligned with the 12 o'clock position on the transducer stem.

Reassemble the transducer and bracket and place them against the transom. Again, check to see if you can move the transducer so it's

parallel with the ground. If you can, then go to step 3B. If it doesn't, repeat step 2B, but use a different alignment letter until you can place the transducer on the transom correctly.

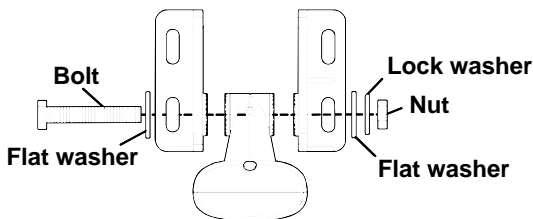

Assemble transducer and bracket.

3. Assembling the transducer.

A. One-piece bracket: Once you determine the correct position for the ratchets, assemble the transducer as shown in the following figure. Don't tighten the lock nut at this time.

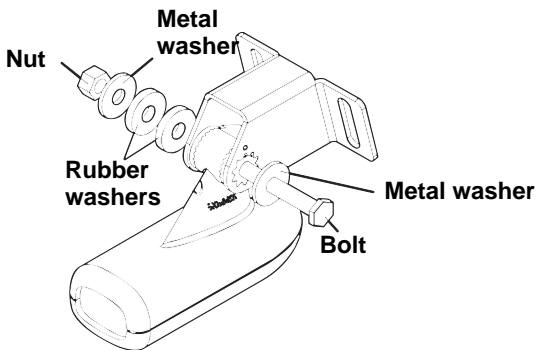

Assemble transducer and bracket.

B. Two-piece bracket: Once you determine the correct position for the ratchets, assemble the transducer as shown in the figure in step 2B. Don't tighten the lock nut at this time.

4. Drilling mounting holes.

Hold the transducer and bracket assembly against the transom. The transducer should be roughly parallel to the ground. The transducer's centerline should be in line with the bottom of the hull. Don't let the bracket extend below the hull!

Mark the center of each slot for the mounting screw pilot holes. You will drill one hole in the center of each slot.

Drill the holes. For the one-piece bracket, use the #29 bit (for the #10 screws). For the two-piece bracket, use the #20 bit (for the #12 screws).

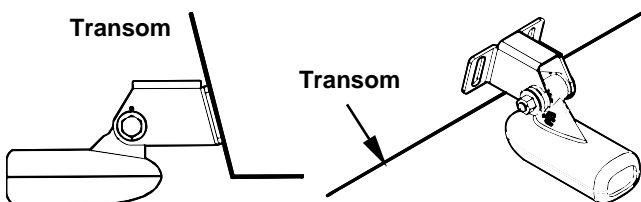

**Position transducer mount on transom and mark mounting holes.
Side view shown at left and seen from above at right.**

5. Attaching transducer to transom.

A. One-piece bracket: Remove the transducer from the bracket and re-assemble it with the cable passing through the bracket over the bolt as shown in the following figures.

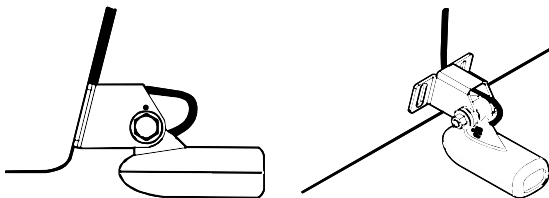

For single-frequency Skimmer, route cable over bolt and through bracket. Side view shown at left and seen from above at right.

Both bracket types: Attach the transducer to the transom. Slide the transducer up or down until it's aligned properly with the bottom of the hull as shown in the preceding and following figures. Tighten the bracket's mounting screws, sealing them with the caulking compound.

Adjust the transducer so that it's parallel to the ground and tighten the nut until it touches the outer washer, then add 1/4 turn. *Don't over tighten the lock nut!* If you do, the transducer won't "kick-up" if it strikes an object in the water.

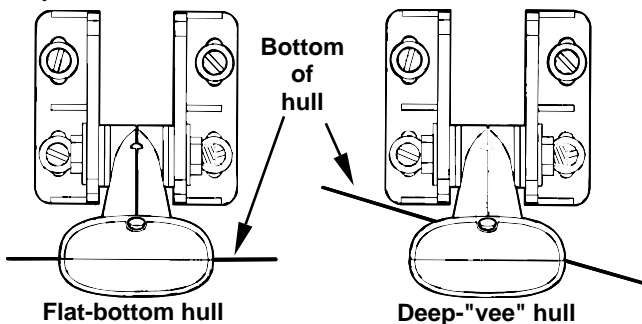

Align transducer centerline with hull bottom and attach transducer to transom. Rear view of dual-frequency Skimmer shown.

6. Route the transducer cable through or over the transom to the sonar unit. Make sure to leave some slack in the cable at the transducer. If possible, route the transducer cable away from other wiring on the boat. Electrical noise from the engine's wiring, bilge pumps, VHF radio wires and cables, and aerators can be picked up by the sonar. Use caution when routing the transducer cable around these wires.

WARNING:

Clamp the transducer cable to the transom close to the transducer. This can prevent the transducer from entering the boat if it is knocked off at high speed.

If you need to drill a hole in the transom to pass the connector through, the required hole size will be 5/8".

Caution:

If you drill a hole in the transom for the cable, make sure it is located above the waterline. After installation, be sure to seal the hole with the same marine grade above- or below-waterline sealant used for the mounting screws.

7. Make a test run to determine the results. If the bottom is lost at high speed, or if noise appears on the display, try sliding the transducer bracket down. This puts the transducer deeper into the water, hopefully below the turbulence causing the noise. Don't allow the transducer bracket to go below the bottom of the hull!

**Trolling Motor Bracket Installation
(single-frequency only)**

1. Attach the optional TMB-S bracket to the transducer as shown in the following figure, using the hardware supplied with the transducer. (Note: The internal tooth washer is supplied with the TMB-S.)

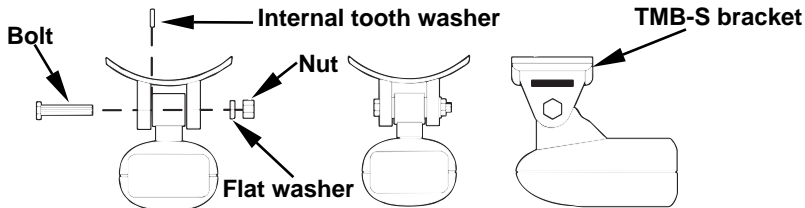

Attach motor mounting bracket to transducer.

2. Slide the adjustable strap supplied with the TMB-S through the slot in the transducer bracket and wrap it around the trolling motor. Position the transducer to aim straight down when the motor is in the water. Tighten the strap securely.

3. Route the transducer cable alongside the trolling motor shaft. Use plastic ties (not included) to attach the transducer cable to the trolling

motor shaft. Make sure there is enough slack in the cable for the motor to turn freely. Route the cable to the sonar unit and the transducer is ready for use.

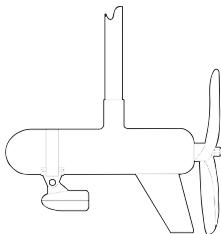

Transducer mounted on trolling motor, side view.

Transducer Orientation and Fish Arches

If you do not get good fish arches on your display, it could be because the transducer is not parallel with the ground when the boat is at rest in the water or at slow trolling speeds.

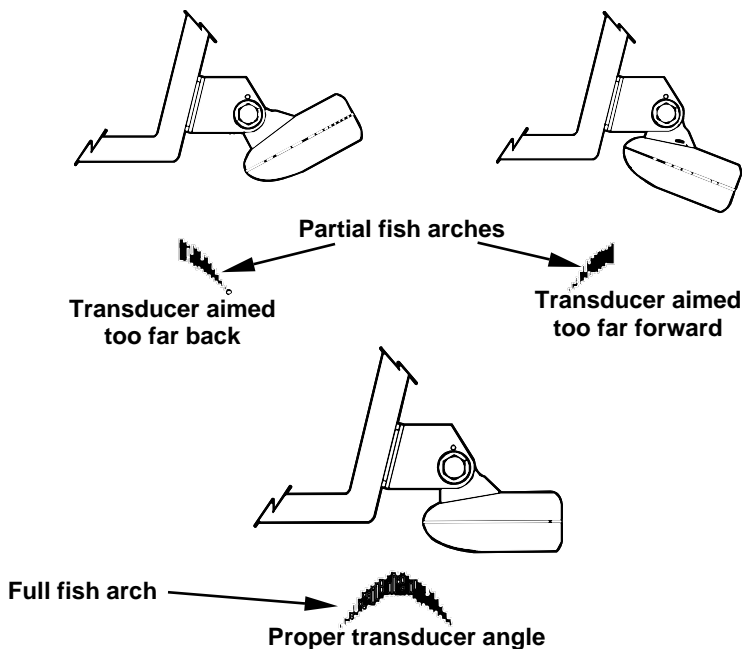

Transducer angles and their effects on fish arches.

If the arch slopes up – but not back down – then the front of the transducer is too high and needs to be lowered. If only the back half of the arch is printed, then the nose of the transducer is angled too far down and needs to be raised.

NOTE:

Periodically wash the transducer's face with soap and water to remove any oil film. Oil and dirt on the face will reduce the sensitivity or may even prevent operation.

Shoot-Thru-Hull Preparation

Hulls With Flotation Materials

The transducer installation inside a fiberglass hull must be in an area that does not have air bubbles in the resin or separated fiberglass layers. The sonar signal must pass through solid fiberglass. A successful transducer installation can be made on hulls with flotation materials (such as plywood, balsa wood or foam) between layers of fiberglass if the material is removed from the chosen area. See the figure below.

WARNING:

Do not remove any material from your inner hull unless you know the hull's composition. Careless grinding or cutting on your hull can result in damage that could sink your boat. Contact your boat dealer or manufacturer to confirm your hull specifications.

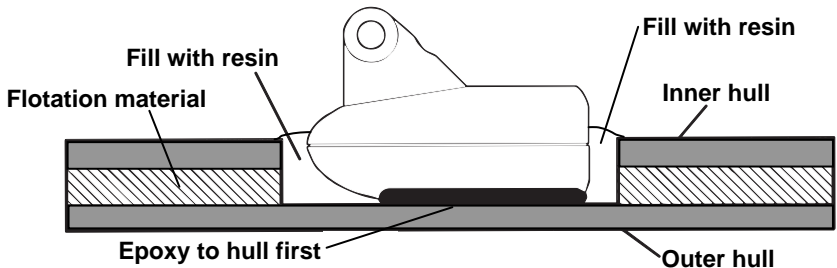

Epoxy the transducer to a solid portion of the hull.

For example, some (but not all) manufacturers use a layer of fiberglass, then a core of balsa wood, finishing with an outer layer of fiberglass. Removing the inner layer of fiberglass and the balsa wood core exposes the outer layer of fiberglass. The transducer can then be epoxied directly to the outer layer of fiberglass. After the epoxy cures for 24 hours, fill the remaining space with polyester resin. When the job is finished, the hull is watertight and structurally sound. Remember, the sonar signal must

pass through *solid* fiberglass. Any air bubbles in the fiberglass or the epoxy will reduce or eliminate the sonar signals.

Testing Determines Best Location

Ideally, the shoot-thru transducer should be installed as close to the transom as possible, close to the centerline. This will give you the best performance during high speed maneuvers.

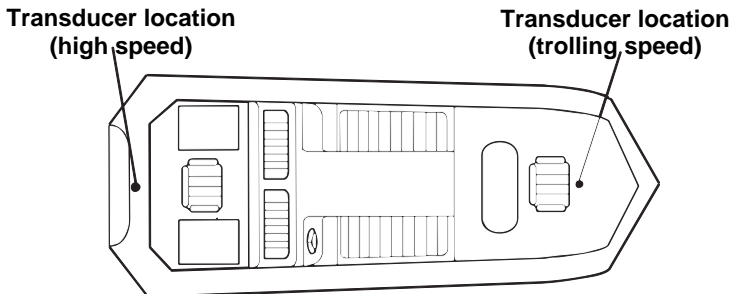

Shoot-thru-hull transducer locations for high speed or trolling speed operation.

To choose the proper location for shoot-thru-hull mounting, follow these testing procedures: (You may need a helper to complete these steps.)

1. Anchor the boat in about 30 feet of water. Add a little water to the sump of the boat. Plug the transducer into the sonar unit, turn it on, then hold the transducer over the side of the boat in the water. Adjust the sensitivity and range controls until a second bottom echo is seen on the display. (You'll need to turn off Auto Sensitivity, Auto Depth Range and ASP™. Try a range setting that is two to three times the water depth. The harder (more rocky) the bottom, the easier it will be to get a second bottom signal.) Don't touch the controls once they've been set.

2. Next, take the transducer out of the water and place it in the water in the sump of the boat, face down. (The transducer face is shown in the figure on the following page.) Notice how the signal strength decreases.

The second bottom signal will probably disappear and the bottom signal intensity will likely decrease.

3. Now move the transducer around to find the best location with the strongest possible bottom signal. If you find a spot with an acceptable bottom signal, mark the location and move on to step 4.

If you can't get an acceptable bottom signal, try turning up the sensitivity by three or five keystrokes and then move the transducer around once more. If you find a spot that works, mark it and move on to step 4.

If you have to turn up sensitivity by more than five keystrokes to get a good signal, the transducer should be mounted on the outside of the hull. This is especially true if you have to turn sensitivity all the way up to get a decent bottom signal.

4. Most people can get good results by following steps 1 through 3, so this step is *optional*. If you want to make an extra effort to be absolutely sure that your selected location will work under all conditions, make a test run with the boat on plane and observe the bottom signal. You'll need to figure some way to prop the transducer into position while you make your test run. (A brick or two might be sufficient to hold it in place.)

5. When you're satisfied with a location, mark it and proceed with the installation.

Shoot-Thru-Hull Installation

If you are installing the transducer on a hull with flotation material sandwiched within the hull, refer to the text "Hulls With Flotation Materials" beginning on page 22.

1. Make sure the area is clean, dry and free of oil or grease, then sand both the inside surface of the hull and the face of the transducer with 100 grit sandpaper. The sanded hull area should be about 1-1/2 times the diameter of the transducer. The surface of the hull must be flat so the entire transducer face is in contact with the hull prior to bonding.

After sanding, clean the hull and transducer with rubbing alcohol to remove any sanding debris.

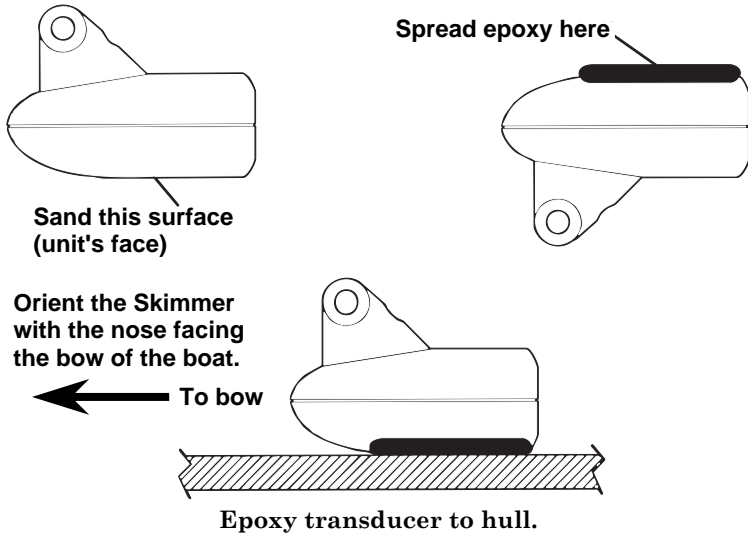

WARNING:

Use *only* the epoxy available from LEI. It has been formulated to work with these installation procedures. Other epoxy types may be too thin or may not cure to the right consistency for optimum transducer performance.

2. The epoxy consists of the epoxy itself and a hardener. Remove the two compounds from the package and place them on the paper plate.

Thoroughly stir the two compounds together until the mixture has a uniform color and consistency. Do not mix too fast or bubbles will form in the epoxy. After mixing, you have 20 minutes to complete the installation before the epoxy becomes unworkable.

Spread a thin layer of epoxy (about 1/16" or 1.5 mm thick) on the face of the transducer as shown in the previous figure. *Make sure there are no air pockets in the epoxy layer!* Then, apply the remaining epoxy to the sanded area on the hull.

3. Press the transducer into the epoxy, twisting and turning it to force any air bubbles out from under the transducer face. Stop pressing when you bottom out on the hull. When you're finished, the face of the transducer should be parallel with the hull, with a minimum amount of epoxy between the hull and transducer.

4. Apply a weight, such as a brick, to hold the transducer in place while the epoxy cures. Be careful not to bump the transducer while the epoxy is wet. Leave the weight in place for a minimum of three hours. Allow the epoxy to cure for 24 hours before moving the boat.

5. After the epoxy has cured, route the cable to the sonar unit and it's ready to use.

Speed/Temperature Sensors

This unit can accept as many as two temperature sensors, which can be used to monitor the temperature of surface water, a live well or some other location. These units can also accept an optional speed sensor for showing speed and distance traveled. However, you can only use one accessory at a time. If you would like to use a speed sensor and a second temperature sensor at the same time, you will need a combination device.

NOTE:

This unit is packed with a transducer containing a built-in temp sensor. The SeaFinder package also includes a speed sensor. If you have a FishMark 500C and want a speed sensor or additional temp sensor, see the Accessory Ordering Information in the back of this manual.

If a *second* temp sensor is used, it must be the model TS-2U. This model has a fixed electronic "address" which designates it as the second of two temp sensors. Dual temperatures are *only* displayed on the Full Chart page. The Large Digital page will only display the *primary* tem-

perature sensor. See the following wiring diagram for temperature and speed sensor combinations.

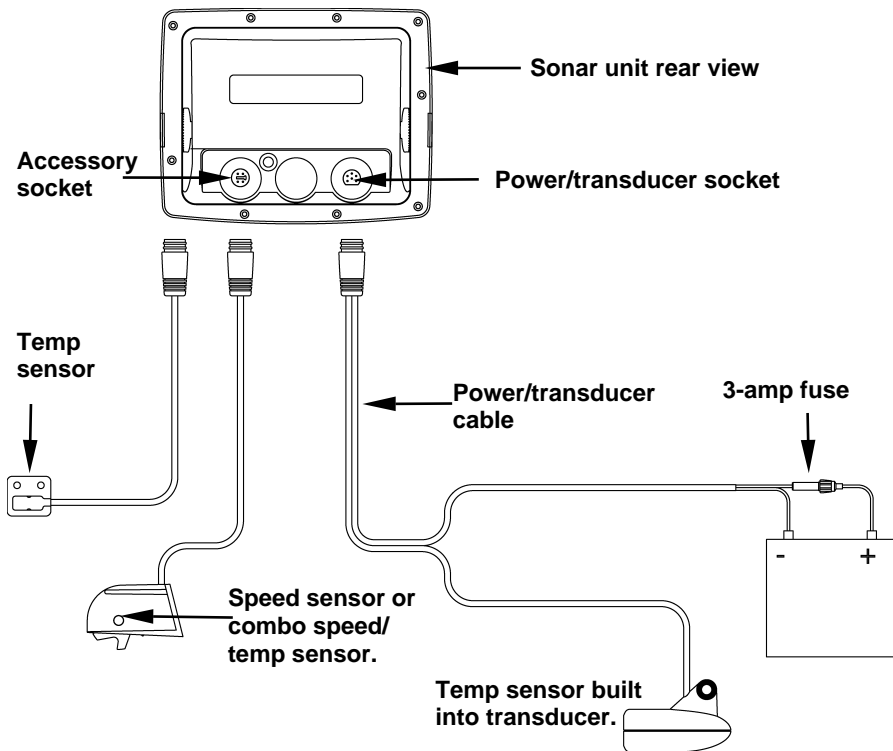

Sonar unit with external temp sensor, external speed sensor, or combo speed/temp sensor. The primary temperature sensor is built into the transducer.

Optional Speed Sensor Installation

All the units in this series can display speed and distance traveled, but only the SeaFinder 500CDF comes packed with a speed sensor. If you

wish to purchase an optional additional sensor for your unit, refer to the accessory ordering information inside the back cover of this manual. The following instructions describe how to install the speed sensor.

Recommended tools for this job include: drill, 5/8" drill bit, 1/8" drill bit for pilot holes, screwdriver. Required supplies for this job include: four #8 stainless steel wood screws (3/4" long), *high quality, marine grade* above- or below-waterline caulking compound.

First find a location on the boat's transom where the water flow is smoothest. Don't mount the sensor behind strakes or ribs. These will disturb the water flow to the speed sensor. Make sure the sensor will remain in the water when the boat is on plane. Also make sure the location doesn't interfere with the boat's trailer. Typically, the sensor is mounted about one foot to the side of the transom's centerline.

Once you've determined the proper location for the unit, place the sensor on the transom. The bottom of the bracket should be flush with the hull's bottom. Using the sensor as a template, mark the hull for the screws' pilot holes. Drill four 1/8" holes, one in each end of the slots.

Mount the sensor to the hull using #8 stainless steel wood screws (not included). Use a *high quality, marine grade* above- or below-waterline caulking compound to seal the screws. Make sure the sensor is flush with the bottom of the hull and tighten the screws.

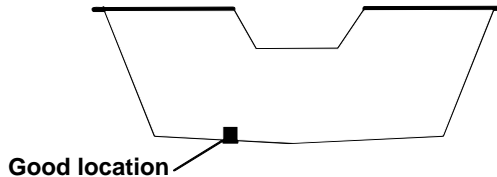

Stern view showing good location for mounting sensor on transom.

If the base of the transom has a radius, fill the gap between the transom and the sensor with the caulking compound. This will help ensure a smooth water flow.

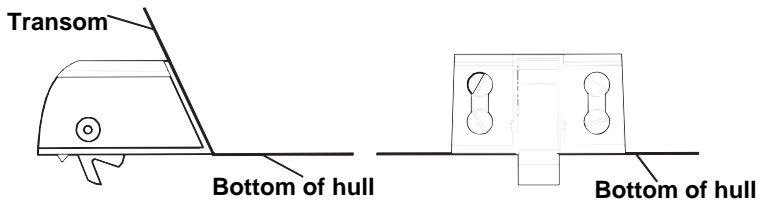

**Speed sensor mounting configuration:
side view (left) and rear view (right.)**

Route the sensor's cable through or over the transom to the sonar unit. If you need to drill a hole in the transom to pass the connector through, the required hole size is 5/8".

Caution:

If you drill a hole in the transom for the cable, make sure it is located above the waterline. After installation, be sure to seal the hole with the same marine grade above- or below-waterline sealant used for the screws.

The sensor is now ready for use. Connect the sensor to the accessory socket on the back of your unit. If you have any questions concerning the installation of the sensor, please contact your local boat dealer.

Power Connections

The unit works from a 12-volt battery system. For the best results, attach the power cable directly to the battery. You can attach the power cable to an accessory or power buss, however you may have problems with electrical interference. Therefore, it's safer to go ahead and attach the power cable directly to the battery.

Caution:

When using the unit in a saltwater environment, we strongly recommend that you shut off the power supply to the power cable when the unit is not in use. When the unit is turned off but still connected to a power supply, electrolysis can occur in the power cable plug.

This may result in corrosion of the plug body along with the electrical contacts in the cable and the unit's power socket.

In saltwater environments we recommend you connect the power cable to the auxiliary power switch included in most boat designs. If that results in electrical interference, or if such a switch is not available, we recommend connecting direct to the battery and installing an inline switch. This will let you shut off power to the power cable when the unit is not in use. When you are not using the unit, you should always shut off power to the power cable, especially when the power cable is disconnected from the unit.

If possible, keep the power cable away from other boat wiring, especially the engine's wires. This will provide the best isolation from electrical noise. If the cable is not long enough, splice #18 gauge wire onto it. The power cable has two wires, red and black. Red is the positive lead, black is negative or ground. Make sure to attach the in-line fuse holder to the red lead *as close to the power source as possible*.

For example, if you have to extend the power cable to the battery or power buss, attach one end of the fuse holder directly to the battery or power buss. This will protect both the unit and the power cable in the event of a short. It uses a 3-amp fuse.

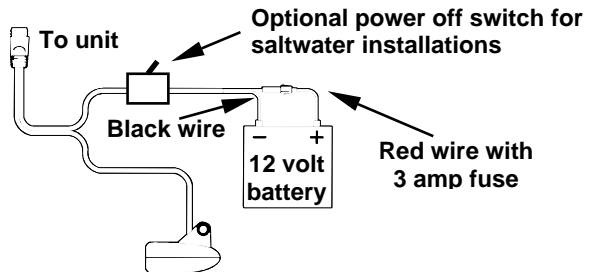

Power connections for the sonar unit.

CAUTION:

Do not use this product without a 3-amp fuse wired into the power cable! Failure to use a 3-amp fuse will void your warranty.

This unit has reverse polarity protection. No damage will occur if the power wires are reversed. However, the unit will not work until the wires are attached correctly.

An optional 8-foot, CA-4 external power cable with a cigarette lighter adapter is available from Eagle.

Mounting the Unit: Bracket, In-Dash or Portable

You can install the sonar unit on the top of a dash with the supplied gimbal bracket. It can also be installed in the dash or mounted on a portable power supply.

If you use the supplied bracket, you may be interested in the optional R-A-M[®] bracket mounting system. This converts the unit's gimbal bracket to a swivel mount, which can be used on the dash or overhead mounting positions. Installation instructions are supplied with the R-A-M mounting kits.

Bracket Installation

Mount the unit in any convenient location, provided there is clearance behind the unit when it's tilted for the best viewing angle. You should also make sure there is enough room behind the unit to attach the power and transducer cables. (A drawing on the next page shows the dimensions of a gimbal-mounted sonar unit.)

Holes in the bracket's base allow wood screw or through-bolt mounting. You may need to place a piece of plywood on the back side of thin fiberglass panels to reinforce the panel and secure the mounting hardware.

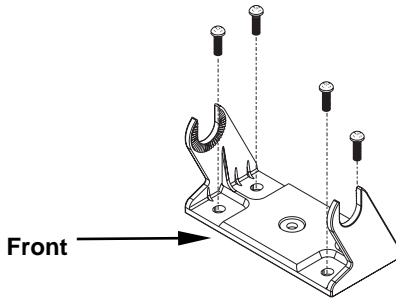

Install the gimbal bracket. Orient the bracket so the arms slope toward the front of your unit.

Drill a 1-inch (25.4 mm) hole in the dash for the power and transducer cables. The best location for this hole is immediately under the gimbal bracket location. This way, the bracket can be installed so that it covers the hole, holds the cables in position and results in a neat installation. Some customers, however, prefer to mount the bracket to the side of the cable hole — it's a matter of personal preference.

After drilling the hole, pass the transducer connector *up* through the hole from under the dash. Pass the power cable's bare-wire end *down* through the hole from the top.

If you wish, you can fill in the hole around the cables with a good marine caulking compound. (Some marine dealers stock cable hole covers to conceal the opening.) No matter what type of installation you prefer, be sure to leave enough slack in the cables to allow tilting or swiveling the unit. If you choose to fill in the hole, be sure to position the cables against the rear edge of the hole as you apply the fill material.

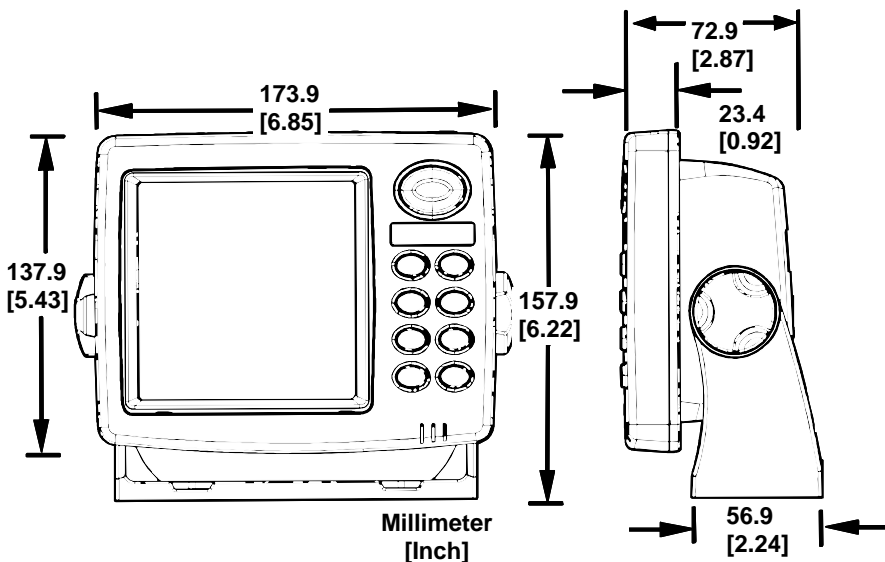

Front view (left) and side view (right) showing dimensions of the sonar unit when mounted on gimbal bracket.

Before positioning the bracket, be sure to hold the cables against the rear edge of the hole. Then, slide the bracket over the hole and butt the rear of the bracket base firmly against the cables, thus pinning them in place against the side of the hole. Finally, fasten the bracket to the dash. Attach the unit to the gimbal bracket using the supplied gimbal knobs and washers.

In-Dash Installation

You can mount the unit in the dash with an optional FM-5 In-Dash Adapter Kit. The kit includes mounting hardware, a template for cutting the hole and an instruction sheet, part 988-0147-43.

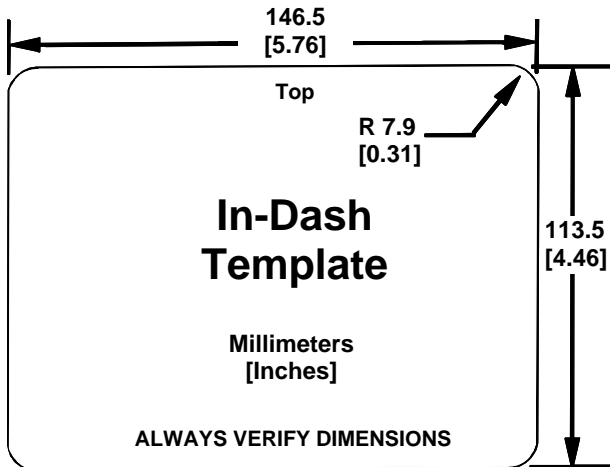

In-dash mounting template for the sonar unit, showing dimensions. NOTE: The figure above is *not* printed to scale. A scaled template (FM-5 In-Dash Adapter Kit instructions) is available for free download from our web site, www.eaglesonar.com.

Portable Installation

Like many Eagle products, this sonar unit is capable of portable operation by using the optional PPP-13 portable power pack. The power pack and an optional portable transducer expand the uses for your sonar unit. The PPP-13 makes it easy to use the unit on your boat or take it to the dock, on a float tube, on an ice fishing trip or use it as a second sonar in a friend's boat.

The PPP-13 Portable Power Pack can be used with eight "D" cell alkaline batteries or an optional sealed, rechargeable battery. For set-up directions, refer to the pack's instruction sheet, part 988-0147-601.

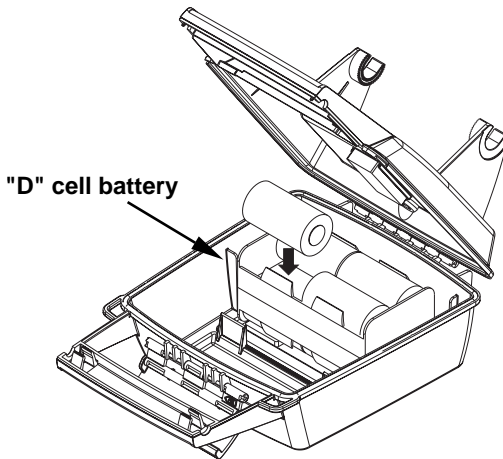

Install batteries in power pack battery adapter.

Face Cover

Your unit comes with a white protective cover that snaps on and off the front of the unit. This cover is intended for use when your unit and the vehicle it's mounted in are idle.

WARNING:

When the unit is mounted in an unprotected area, such as an open boat cockpit, the protective face cover must be removed when the vehicle is moving at high speed. This includes towing a boat on a trailer at highway speeds. Otherwise, wind blast can pop off the cover.

Notes

Basic Sonar Operation

This section addresses the unit's *most basic* sonar operations. The instructions presented in Sec. 3 follow a chronological order. Sec. 4, *Sonar Options & Other Features*, will discuss other more advanced functions and utilities. Material in Sec. 4 is arranged in alphabetical order.

Before you turn on the sonar unit, it's a good idea to learn about the different keys, the Main Menu, the four Page screens and how they all work together. BUT, if you just can't wait to get on the water, turn to the one-page *Quick Reference* on page 45.

Keyboard

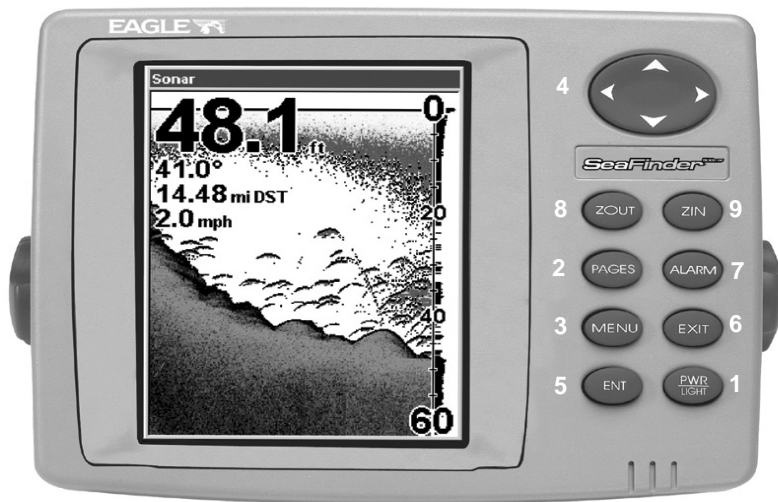

The SeaFinder 500CDF sonar unit, front view, showing full sonar chart screen display and keyboard.

1. **PWR/LIGHT** (Power & Light) – The PWR key turns the unit on and off and activates the backlight.
2. **PAGES** – Pressing this and the ↑ and ↓ arrow keys switches the unit between the three different page display options. (Full Sonar Chart, Split Zoom Sonar Chart and Digital Data.)
3. **MENU** – Press this key to show the menus and submenus, which allow you to select a command or adjust a feature.
4. **ARROW KEYS** – These keys are used to navigate through the menus, make menu selections, move the chart cursor and enter data.
5. **ENT** (Enter) – This key allows you to save data, accept values or execute menu commands.
6. **EXIT** – The Exit key lets you return to the previous screen, clear data or clear a menu.
7. **ALARM** –The Alarm key is a shortcut to access the various sonar alarms. Press this key once to open the Alarms menu.
8. **ZOUT** – (Zoom Out) – This key lets you zoom the screen out. This key allows you to see the entire water column from surface to bottom.
9. **ZIN** – (Zoom In) – This key lets you zoom the screen in. This key enlarges fish signals and bottom detail.

Power/lights on and off

To turn on the unit, press **PWR**. As the unit powers up, the Full Sonar Chart is displayed first.

To turn on the backlight, press **PWR** again. The unit has three backlight levels to select from. Repeatedly pressing **PWR** will cycle through the backlight settings and turn off the backlight.

Turn off the unit by pressing and holding the **PWR** key for 3 seconds.

Main Menu

The unit has a Main Menu, which contains some function commands and some setup option commands. The instructions in this section will deal only with sonar functions, the basic commands that make the unit show sonar signals on your screen. This sonar unit will work fine right out of the box with the factory default settings. But, if you want to learn about the various sonar options, see Sec. 4, *Sonar Options & Other Features*.

You can access the Main Menu from any of the four Page screens by pressing **MENU | MENU**. To clear the menu screen and return to the page display, press **EXIT**. (Remember, our text style for "**MENU | MENU**" means "press the Menu key twice." See a full explanation of our instruction text formatting on pages 5, "*How to use this manual...*".

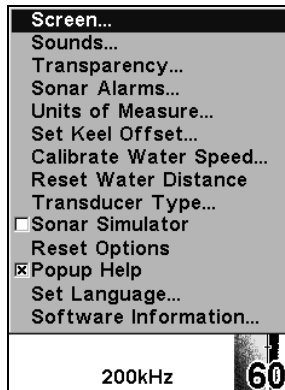

Main Menu.

The Main Menu commands and their functions are:

Screen command: changes the contrast or brightness of the display screen.

Sounds command: enables or disables the sounds for key strokes and alarms and sets the alarm style.

Transparency command: adjust the level of transparency for dialogs.

Sonar Alarms command: turns sonar alarms on or off and changes alarm thresholds.

Units of Measure command: changes the depth, speed, distance, or temperature units of measure.

Set Keel Offset command: changes the depth offset of the keel from the transducer.

Calibrate Water Speed command: calibrates the speed measurement.

Reset Water Distance command: resets the log of distance traveled to zero.

Transducer Type command: sets the type of transducer connected to the unit.

Sonar Simulator command: scrolls simulated data on the sonar chart.

Reset Options command: resets all options to factory default settings.

Popup Help command: turns popup help on or off.

Set Language command: chooses which language text appears in.

Software Information command: shows the product name and software version.

Pages

The unit has three Page display options, accessed by pressing the **PAGES** key. The list of display options appears in the following image.

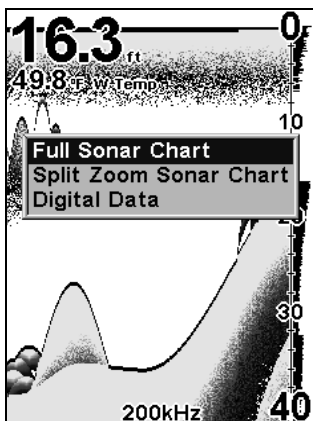

Pages Menu, showing Sonar display options.

All of the display options show the sonar chart in some format. This is a "cross-section" view of the water column beneath the boat. The chart moves across the screen, displaying sonar signal echoes that represent fish, structure and the bottom.

The Pages Menu allows you to switch among the three chart display options. To access them, press **PAGES** | \uparrow or \downarrow to *Option Name* | **EXIT**.

The Sonar Page has its own menu, which is used for some advanced functions and for setting various options. (Sonar Options and other features are discussed in Sec. 4.) To Access the Sonar Page menu, press **MENU**.

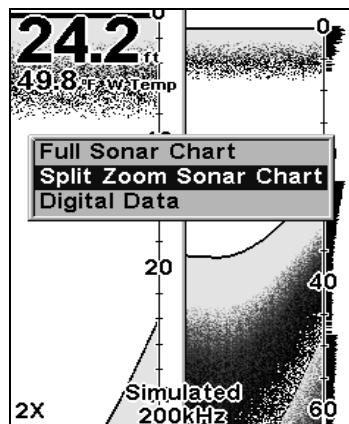

Sonar Page in split zoom sonar chart display mode.

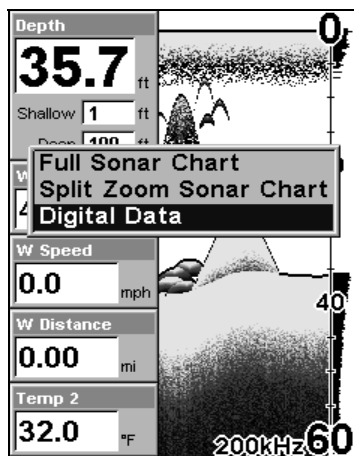

Sonar chart digital data display option.

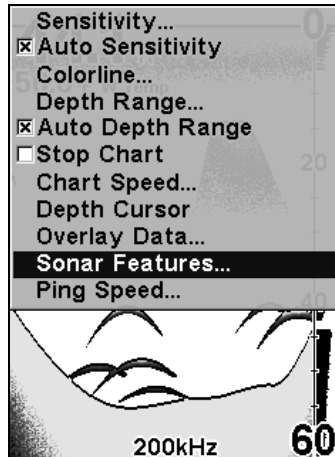

Sonar Page Menu. Most of these functions are discussed in Sec. 4.

You can customize how the Sonar Page displays its pictures and other data in many ways. Your unit also includes several special sonar features and options that can help you better interpret the underwater scene.

We'll discuss all of those features and options in Sec. 4, but to show you how easy this unit is to operate, the following page contains a simplified, 10-step quick reference that will cover most fish finding situations. The quick reference describes how your unit will operate with all the sonar features in their automatic modes, which are set at the factory.

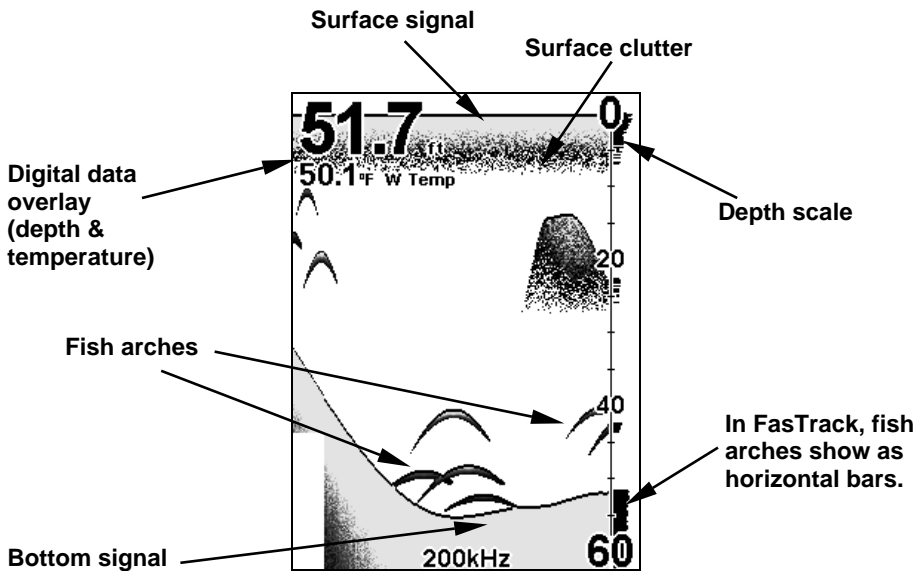

Sonar Page, showing full sonar chart mode.

Basic Sonar Quick Reference

1. Mount the transducer and unit. Connect the unit to electric power and the transducer.
2. Launch your boat.
3. To turn on the unit, press and release **PWR** key.
4. Head for your fishing grounds. Your unit automatically displays digital depth and surface water temperature in the corner of the screen.

The auto settings will track the bottom, displaying it in the lower portion of the screen. The full sonar chart will scroll from right to left, showing you what's under the boat as you cruise across the water.

5. As you're watching the sonar returns, you can change the display by:

Zoom in to enlarge the chart for more detail: press **ZIN**.

Zoom out to return to full chart mode: press **ZOUT**.

6. If necessary, adjust sensitivity to improve chart readability. Press **MENU|ENT** and the Sensitivity Menu will appear on the left of your screen. Use **↑** and **↓** to change the setting.

Boosting sensitivity will show more information on your screen, which may cause clutter. Reducing sensitivity will filter out some information, but could omit important images. We recommend adjusting sensitivity until the background is lightly "peppered" — that is, scattered dots appear, but individual objects (like fish arches or bottom structure) can be easily picked out of the background.

7. Watch the display for the appearance of fish arches. When you see arches, you've found fish! Stop the boat and get your lure or bait into the water at the depth indicated on the sonar chart.
8. Gauge the fish depth by visually comparing the fish arches with the depth scale on the right side of the screen, or get a more accurate measure with the Depth Cursor. Press **MENU|↓** to **DEPTH CURSOR|ENT**.

Press ↓ (or ↑) to align the cursor line with the fish arch. The exact depth appears in a box at the right end of the cursor line. To clear the cursor, press **EXIT**.

9. If you are drifting at a very low speed or anchored, you are not moving fast enough for a fish to return the tell-tale fish arch signal. As you drift over a fish, or as a fish swims through the transducer's signal cone, the fish echo will appear as a straight line suspended between the surface and the bottom.

10. To turn off the unit, press and hold **PWR** key for three seconds.

Sonar Operations

As you can see from the quick reference on the previous page, basic operation is pretty easy, right out of the box. If you are a sonar novice, try operating the unit with the factory defaults until you get a feel for how it's working.

As you're learning the basics, there is one setting you might want to tinker with from time to time — Sensitivity.

Sensitivity controls the unit's ability to pick up echoes. If you want to see more detail, try increasing the sensitivity, a little at a time. There are situations when too much clutter appears on the screen. Decreasing the sensitivity can reduce the clutter and show the strongest fish echoes, if fish are present. As you change the sensitivity setting, you can see the difference on the chart as it scrolls.

Fig. 1



Fig. 2

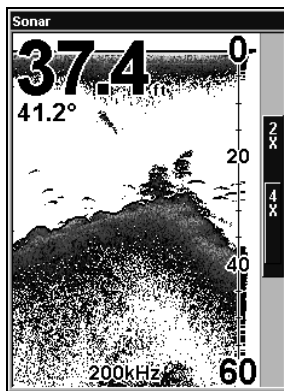

Fig. 3

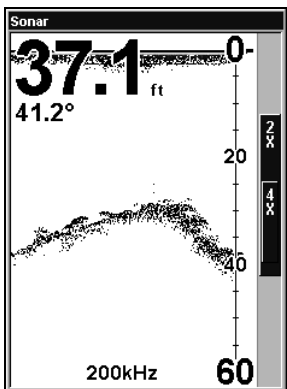

Fig. 4



These figures show results of different sensitivity levels on the same location. Fig. 1: Sensitivity at 88 percent, determined by Auto Sensitivity. Typical of full auto mode. Fig. 2: Sensitivity set at 75 percent. Fig. 3: Sensitivity set at 50 percent. Fig. 4: Sensitivity set at 100 percent.

You can change the sensitivity level whether you are in Auto Sensitivity mode or Manual Sensitivity mode. The adjustment method works the same in both modes, but it gives you slightly different results.

Adjusting sensitivity in Auto Sensitivity Mode is similar to manually adjusting a car's speed with the accelerator pedal while cruise control is on. You can tell the car to run faster, but when you let off the gas the cruise control *automatically* keeps you from running slower than the minimum speed setting. In the unit, auto mode will let you increase sensitivity to 100 percent, but the unit will *limit* your *minimum* setting. This prevents you from turning sensitivity down too low to allow automatic bottom tracking. When you change the setting with auto turned on, the unit will continue to track the bottom and make minor adjustments to the sensitivity level, with a bias toward the setting you selected.

Adjusting sensitivity in Manual Sensitivity Mode is similar to driving a car without cruise control — you have *complete* manual control of the car's speed. In the unit, manual mode allows you to set sensitivity at 100 percent (maximum) or zero percent (minimum.) Depending on water conditions, the bottom signal may completely disappear from the screen when you reduce sensitivity to about 50 percent or less!

Try adjusting sensitivity in both auto and manual modes to see how they work.

To adjust sensitivity:

1. Press **MENU | ENT**.
2. The Sensitivity Control Bar appears. Press ↓ to decrease sensitivity; press ↑ to increase sensitivity. When it's set at the desired level, press **EXIT**. (When you reach the maximum or minimum limit, a tone sounds.)

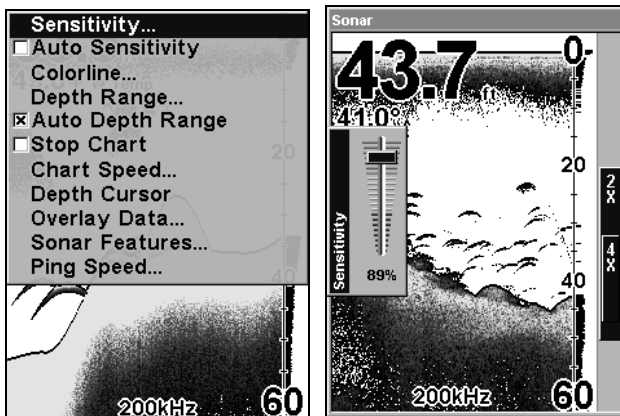

At left, Sonar Menu with Sensitivity command selected. At right, the Sensitivity Control Bar.

NOTE:

If you want to change the sensitivity in Manual Mode, first turn off Auto Sensitivity: from the Sonar Page, press **MENU** | **↓** to **AUTO SENSITIVITY** | **ENT** | **↑** to **SENSITIVITY** | **ENT**. Press **↓** or **↑** to pick a different sensitivity setting. When it's set at the desired level, press **EXIT**.

Important Tip:

While you are experimenting and learning, it's possible to scramble the settings so that the sonar picture disappears from your screen. If that happens, remember that it's easy to switch back to full automatic operation by simply restoring the factory auto settings.

To Restore Factory Settings

1. Press **MENU** | **MENU** | **↓** to **RESET OPTIONS** | **ENT**.
2. The unit asks if you want to reset all the options. Press **←** to **YES** | **ENT**. All options are reset, and the unit reverts back to the Full Sonar Chart.

Fish Symbols vs. Full Sonar Chart

You may have noticed in the quick reference that we used fish arches in full sonar chart mode for our example, and not the popular Fish I.D.[™] fish symbol feature. Here's why.

Fish I.D. *is* an easier way for a sonar novice to recognize a fishy signal return when he sees it. However, locating fish by symbol *only* has some limitations.

Your sonar unit's microprocessor is remarkably powerful, but it can be fooled. Some of the echoes *calculated* to be fish could be tree limbs or turtles! *To see what's under your boat in maximum detail, we recommend you turn off Fish I.D. and begin learning to interpret fish arches.*

Fish I.D. is most handy when you're in another part of the boat or performing some task that prevents you from watching the sonar screen. Then, you can turn on Fish I.D. and the audible fish alarm. When that lunker swims under your boat, you'll hear it!

Fish I.D. can also be useful when you want to screen out some of the sonar detail gathered by your unit. For example, in one case fisherman in San Francisco Bay saw clouds of clutter in the water but no fish arches. When a down rigger was pulled up, it brought up several small jellyfish. The fisherman switched their sonar to Fish I.D., which screened out the schools of jellyfish and clearly showed the game fish there as fish symbols.

Other Free Training Aids

The sonar options section discusses Fish I.D., fish alarms and other features in greater detail. If you or a friend has Internet access, you can also learn more about interpreting what you see on your sonar screen. Visit our web site, **WWW.EAGLESONAR.COM**. Be sure to check out the free Sonar Tutorial, which includes animated illustrations and more pictures of actual sonar returns, all described in detail. There's even a "printer friendly" version of the tutorial available on our web site...it makes a great supplement to this operation manual!

For the ultimate training aid, be sure to download the free emulator software for your unit. Aside from being just plain fun, this program can help you learn both basic and advanced operations without burning boat fuel! Eagle is one of the first sonar manufacturers to provide this type of training tool for customers.

This PC application simulates the actual sonar unit on your computer. You can run it from your computer keyboard or use your mouse to press the virtual keys. Easy download and installation instructions are available on our web site.



Free training emulator is available for your unit on our web site.

Notes

Section 4: Sonar Options & Other Features

Material in this section is arranged in alphabetical order.

ASP™ (Advanced Signal Processing)

The ASP™ feature is a noise rejection system built into the sonar unit that constantly evaluates the effects of boat speed, water conditions and interference. This automatic feature gives you the best display possible under most conditions.

The ASP feature is an effective tool in combating noise. In sonar terms, noise is any undesired signal. It is caused by electrical and mechanical sources such as bilge pumps, engine ignition systems and wiring, air bubbles passing over the face of the transducer, even vibration from the engine. In all cases, noise can produce unwanted marks on the display.

The ASP feature has four settings — Off, Low, Medium and High. If you have high noise levels, try using the "High" ASP setting. However, if you are having trouble with noise, we suggest that you take steps to find the interference source and fix it, rather than continually using the unit with the high ASP setting.

There are times when you may want to turn the ASP feature off. This allows you to view all incoming echoes before they are processed by the ASP feature.

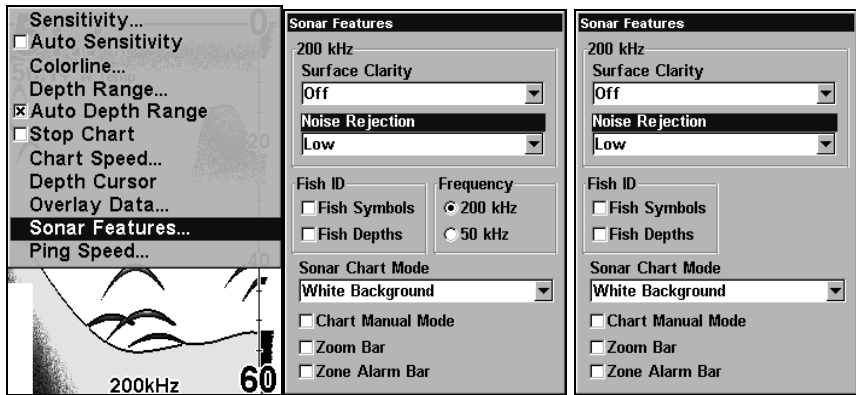

At left, Sonar Menu with Sonar Features selected. In the Sonar Features menu, Noise Rejection is selected with ASP in the default low setting (center, dual-frequency menu; at right, single-frequency menu).

To change the ASP level:

1. From the Sonar Page, press **MENU** | **↓** to **SONAR FEATURES** | **ENT**.
2. Press **↓** to **NOISE REJECTION** | **ENT**.
3. Press **↓** or **↑** to select a setting, then press **ENT**.
4. To return to the previous page, press **EXIT** | **EXIT**.

Alarms

This unit has three different types of sonar alarms. The first is the Fish Alarm. It sounds when the Fish I.D.TM feature determines that an echo is a fish.

Another alarm is the Zone Alarm, which consists of a bar on the side of the screen. Any echo on the chart that appears inside this bar triggers this alarm.

The last alarm is the Depth Alarm, which has both a Shallow and a Deep setting. This is useful as an anchor watch, a shallow water alert or for navigation.

Depth Alarms

The depth alarms sound a tone when the bottom signal goes shallower than the shallow alarm's setting or deeper than the deep alarm's setting. For example, if you set the shallow alarm to 10 feet, the alarm will sound a tone if the bottom signal is less than 10 feet. It will continue to sound until the bottom goes deeper than 10 feet.

The deep alarm works just the opposite. It sounds a warning tone if the bottom depth goes deeper than the alarm's setting. Both depth alarms work only off the digital bottom depth signals. No other targets will trip these alarms. These alarms can be used at the same time or individually.

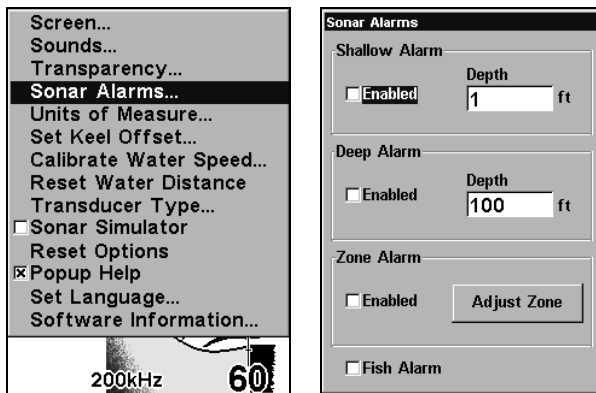

At left, Main Menu and Sonar Alarms command.
At right, the Sonar Alarms menu.

To adjust and turn on the shallow alarm:

1. Press **ALARM** | → to **SHALLOW ALARM DEPTH** | **ENT**.

2. Press ↑ or ↓ to change the first number, then press → to move the cursor to the next number and repeat until the depth is correct, then press **ENT**.

3. Press ← to **SHALLOW ALARM ENABLED | ENT | EXIT**.

4. To turn off the alarm, press **ALARM | ENT | EXIT**.

To switch to a different depth setting, open the Sonar Alarms menu and repeat the instructions in step 3 above.

To adjust and turn on the deep alarm:

1. Press **ALARM | ↓** to **DEEP ALARM ENABLED | →** to **DEEP ALARM DEPTH | ENT**.

2. Press ↑ or ↓ to change the first number, then press → to move the cursor to the next number and repeat until the depth is correct, then press **ENT**.

3. Press ← to **DEEP ALARM ENABLED | ENT | EXIT**.

4. To turn off the alarm, press **ALARM | ↓** to **DEEP ALARM ENABLED | ENT | EXIT**.

To switch to a different depth setting, open the Sonar Alarms menu and repeat the instructions in step 3 above.

Zone Alarm

The zone alarm is triggered when any echo passes inside the zone alarm bar, shown on the right side of the screen.

To adjust and turn on the zone alarm:

1. Press **ALARM | ↓** to **ZONE ALARM ENABLED | →** to **ADJUST ZONE | ENT**.

2. To set the upper boundary for the Zone Alarm, use ← or → to select **UPPER**, then press ↑ or ↓ to move the top of the bar to the desired depth.

3. To set the lower boundary for the Zone Alarm, use ← or → to select **LOWER**, then press ↑ or ↓ to move the bottom of the bar to the desired depth.

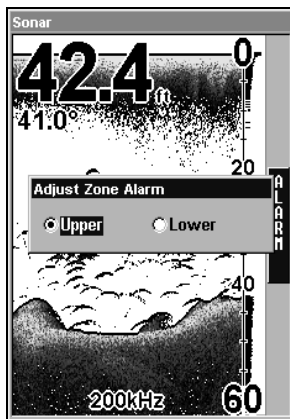
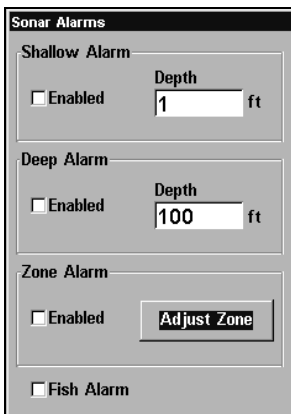

At left, Sonar Alarms menu, with Adjust Zone command selected.

At right, Adjust Zone Alarm selection box, with Upper selected.

4. Press **EXIT** | **←** to **ZONE ALARM ENABLED** | **ENT** | **EXIT**. Now, any echo — fish, bottom, structure — within the zone alarm's depth range will trigger the zone alarm.

5. To turn off the alarm, press **ALARM** | **↓** to **ZONE ALARM ENABLED** | **ENT** | **EXIT**.

To switch to a different depth setting, open the Sonar Alarms menu and repeat the instructions in steps 3 and 4 above.

Fish Alarm

Use the fish alarm for a distinctive audible alarm when fish or other suspended objects are detected by the Fish I.D.[™] feature (Fish I.D. must be turned on for the Fish Alarm to work). A different tone sounds for each fish symbol size shown on the display.

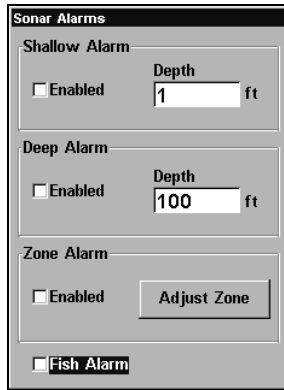

Sonar Alarms menu with Fish Alarm selected. The check box to the left is blank, indicating the alarm is turned off.

To turn the fish alarm on:

1. Press **ALARM** | ↓ to **FISH ALARM** | **ENT** | **EXIT**.
2. To turn off the alarm, press **ALARM** | ↓ to **FISH ALARM** | **ENT** | **EXIT**.

Backlight Level

The unit defaults to the maximum backlight level. To adjust the display's backlight level:

Press **MENU** | **MENU** | ↓ to **BACKLIGHT LEVEL** | **ENT**. The **BACKLIGHT LEVEL** slider bar appears. Press ↑ or ↓ to move the bar. At The lower end of the scale backlighting is turned off; the upper end is maximum backlight level.

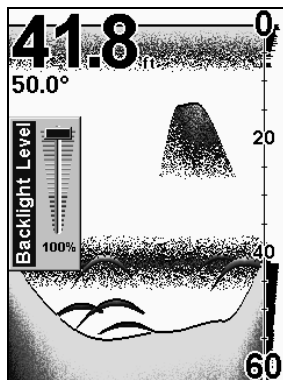

The Backlight Level control bar appears automatically whenever you turn on the unit.

Calibrate Speed

The speed sensor can be calibrated to compensate for inaccuracies. Before you change the setting, first calculate the percentage that the speed is off. You will enter this percentage in a moment.

For example, if you figure the sensor is reading 10 percent faster than actual speed, you will enter -10 in the calibration window. If the sensor is reading 5 percent slower than true speed, you will enter $+5$ in the window.

When you make a run to compare your ground speed to speed sensor speed, perform your test in relatively calm water free of current, if possible. (Unless, of course, you are taking the current speed into consideration when making your calculation.) After you have a correction figure, here's how to enter it:

1. Press **MENU | MENU | ↓ to CALIBRATE WATER SPEED | ENT.**

2. Enter the number you calculated earlier: press \uparrow or \downarrow to change the first character (+ or -), then press \rightarrow to move the cursor to the next number and repeat until the percentage is correct, then press **EXIT**.

Chart Speed

The rate that echoes scroll across the screen is called the chart speed. The default is maximum; we recommend that you leave the speed set there for virtually all fishing conditions.

However, you might consider experimenting with chart speed when you are stationary or drifting very slowly. You may sometimes achieve better images as you slow down the chart speed to match how fast you are moving across the bottom.

If you are at anchor, ice fishing or fishing from a dock, experiment with a chart speed around 50 percent. If you are drifting slowly, try a chart speed around 75 percent. When you are stationary and a fish swims through the sonar signal cone, the image appears on the screen as a long line instead of a fish arch. Reducing the chart speed may result in a shorter line that more closely resembles a regular fish return.

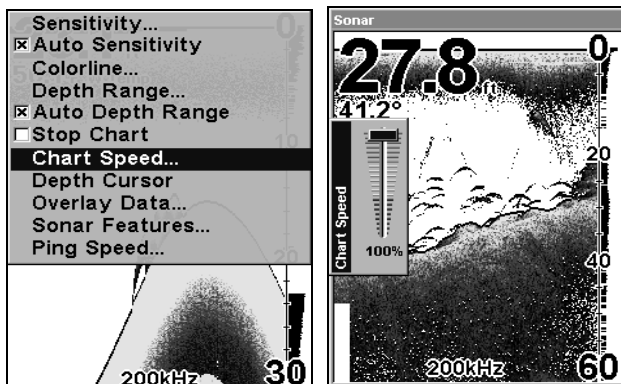

At left, Sonar Page menu with Chart Speed command selected.
At right, Chart Speed Control Bar.

If you do experiment with chart speed, remember to reset it to maximum when you resume trolling or moving across the water at higher speed. To change chart speed:

1. From the Sonar Page, press **MENU** | ↓ to **CHART SPEED** | **ENT**.
2. The Chart Speed Control Bar appears. Press ↓ to decrease chart speed; press ↑ to increase chart speed.
3. When it's set at the desired level, press **EXIT**.

ColorLine™

ColorLine lets you distinguish between strong and weak echoes. It "paints" a brighter color on targets that are stronger than a preset value. This allows you to tell the difference between a hard and soft bottom. For example, a soft, muddy or weedy bottom returns a weaker signal which is shown with a narrow, colored line (dark blue tinged with red or a little yellow.) Since fish are among the weakest echoes, they show up mostly as blue arches. A hard bottom or other relatively hard target returns a strong signal which causes a wider brightly colored line (reddish yellow to bright yellow.)

If you have two signals of equal size, one with red to yellow color and the other without, then the target with brighter color (yellow) is the stronger signal. This helps distinguish weeds from trees on the bottom, or fish from structure.

ColorLine is adjustable. Experiment with your unit to find the ColorLine setting that's best for you. To adjust the ColorLine level:

1. From the Sonar Page, press **MENU** | ↓ to **COLORLINE** | **ENT**.
2. The ColorLine Control Bar appears. Press ↓ to decrease ColorLine; press ↑ to increase Colorline.
3. When it's set at the desired level, press **EXIT**.

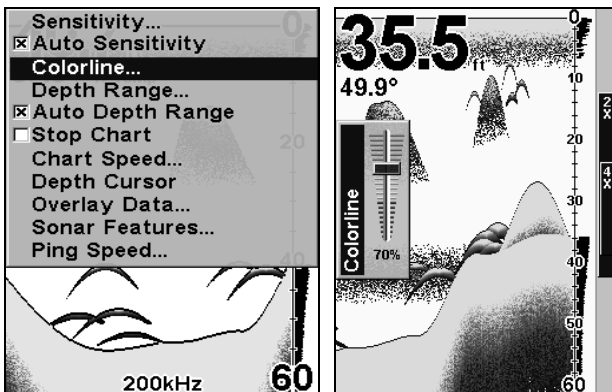

At left, Sonar Page menu with ColorLine command selected.
At right, the ColorLine control bar.

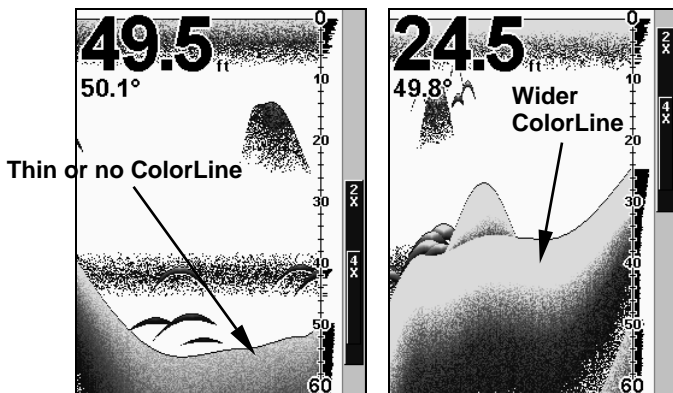

At left, little ColorLine indicates a soft bottom, probably sand or mud.
At right, the wider ColorLine indicates a harder, rocky bottom.

Contrast

To adjust the display's contrast: Press **MENU | MENU | ENT**. The **CONTRAST** slider bar appears. Press **↑** or **↓** to move the bar. The lower end of the scale is minimum contrast; the upper end is maximum contrast.

Depth Cursor

The depth cursor consists of a horizontal line with a digital depth box on the right side. The numbers inside the box show the depth of the cursor.

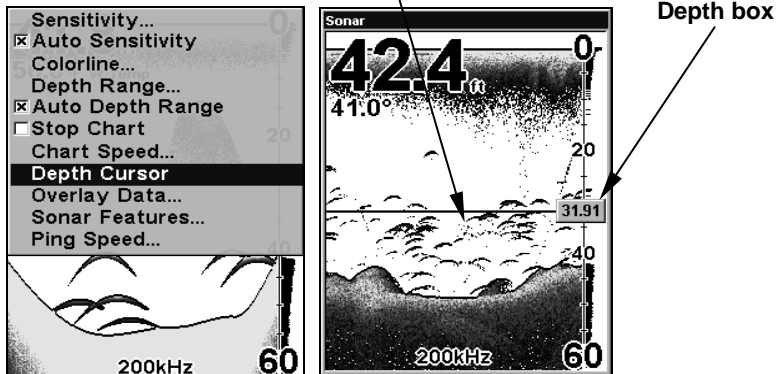

At left, Sonar Page menu with Depth Cursor command selected. At right, sonar chart with the depth cursor active. The school of fish is 31.91 feet deep.

The cursor can be moved to any location on the screen, letting you pinpoint the depth of a target.

1. From the Sonar Page, press **MENU | ↓** to **DEPTH CURSOR | ENT**.
2. The depth cursor appears. Press **↓** to lower the cursor line; press **↑** to raise the cursor line.
3. To clear the depth cursor, press **EXIT**.

Depth Range - Automatic

When turned on for the first time, the bottom signal is automatically placed in the lower half of the screen. This is called Auto Ranging and is part of the automatic function. However, depending upon the bottom depth and the current range, you can change the range to a different depth. To do this:

1. From the Sonar Page, press **MENU** | ↓ to **DEPTH RANGE** | **ENT**.

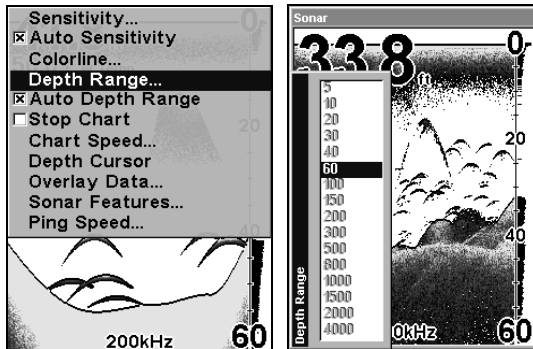

At left, Sonar Page menu with Depth Range command selected. At right, the Depth Range Control Scale.

2. The Depth Range Control Scale appears. Press ↑ or ↓ to select a different depth range. A blue bar highlights the selected range. The lighter numbers cannot be selected.
3. When the new range is selected, press **EXIT** to clear the menu.

Depth Range - Manual

You have complete control over the range when the unit is in the manual mode. There are 16 depth ranges, from 5 feet to 4,000 feet.

To switch to Manual Depth Range:

1. First, turn off automatic depth range. From the Sonar Page, press **MENU** | ↓ to **AUTO DEPTH RANGE** | **ENT**.
2. Press ↑ to **DEPTH RANGE** | **ENT** and the Depth Range Control Scale appears.
3. Press ↓ or ↑ to select a different depth range. A horizontal black bar highlights the selected range.
4. When the new range is selected, press **EXIT** to clear the menu.

To turn Auto Depth Range on again:

From the Sonar Page, press **MENU** | ↓ to **AUTO DEPTH RANGE** | **ENT** | **EXIT**.

NOTE:

The sonar's depth capability depends on the transducer installation, water and bottom conditions, and other factors.

FasTrack™

This feature automatically converts all echoes to short horizontal lines on the display's far right side. The graph on the rest of the screen continues to operate normally. FasTrack gives you a rapid update of conditions directly under the boat. This makes it useful for ice fishing, or when you're fishing at anchor. When the boat is not moving, fish signals are long, drawn out lines on a normal chart display. FasTrack converts the graph to a vertical bar graph that, with practice, makes a useful addition to fishing at a stationary location.

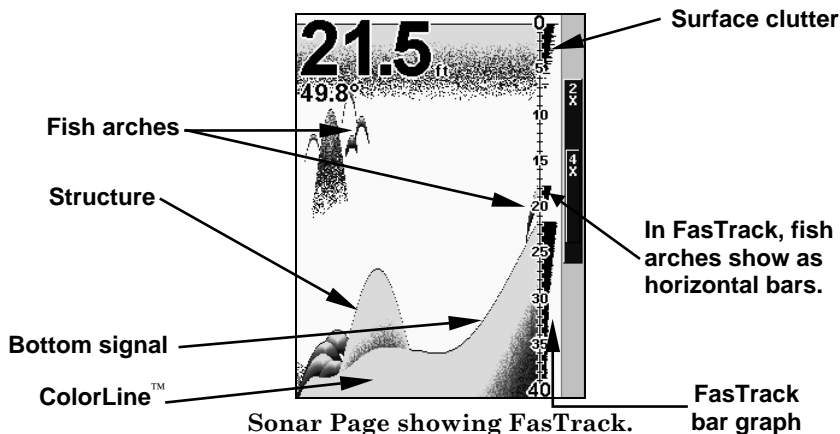

Fish I.D.™ (Fish Symbols & Depths)

The Fish I.D. feature identifies targets that meet certain conditions as fish. The microcomputer analyzes all echoes and eliminates surface clutter, thermoclines, and other signals that are undesirable. In most instances, remaining targets are fish. The Fish I.D. feature displays fish symbols on the screen in place of the actual fish echoes.

There are several fish symbol sizes. These are used to designate the relative size between targets. In other words, Fish I.D. displays a small fish symbol when it thinks a target is a small fish, a medium fish symbol on a larger target and so on.

The sonar's microcomputer is sophisticated, but it can be fooled. It can't distinguish between fish and other suspended objects such as trotlines, turtles, submerged floats, air bubbles, etc. Individual tree limbs extending outwards from a group of limbs is the hardest object for the Fish I.D. feature to distinguish from fish.

You may see fish symbols on the screen when actually, there are no fish. The reverse is also true. The illustrations on the next page show how Fish I.D. can actually *miss* fish that *are* present.

Does that mean Fish I.D. is broken? No — the feature is simply interpreting sonar returns in a specific way to help take some of the work out of reading the screen. Remember: Fish I.D. is one of the many tools we provide so you can analyze your sonar returns for maximum fish finding information. This and other features can help you successfully "see" beneath the boat under varied water and fishing conditions. So, practice with the unit in both the Fish I.D. mode and without to become more familiar with the feature. The default for Fish I.D. is off.

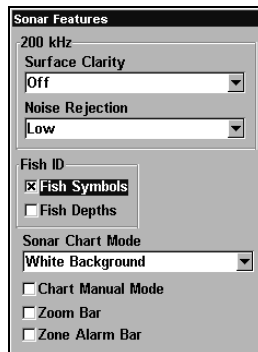
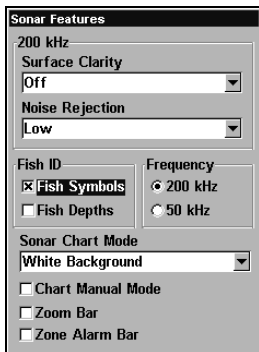

Sonar Features menu with Fish I.D. Symbols selected (at left, dual-frequency menu; at right, single-frequency menu). When the check box to the left is checked, the feature is on.

To turn the Fish I.D. feature on:

1. From the Sonar Page, press **MENU** | ↓ to **SONAR FEATURES** | **ENT**.
2. Press ↓ to **SYMBOLS** | **ENT** | **EXIT** | **EXIT**.

To turn off Fish I.D., repeat the instructions in step 2.

FishTrack™

The FishTrack feature shows the depth of a fish symbol when it appears on the display. This lets you accurately gauge the depth of targets. This feature is available only when the Fish I.D. feature is on. The default setting for FishTrack is off.

To turn on FishTrack:

(Note: These instructions will turn on FishTrack *and* Fish I.D. at the same time.)

1. From the Sonar Page, press **MENU** | ↓ to **SONAR FEATURES** | **ENT**.
2. Press ↓ to **DEPTHS** | **ENT** | **EXIT** | **EXIT**.

To turn off FishTrack, repeat the instructions in step 1. Turning off FishTrack in this manner will not turn off Fish I.D. symbols.

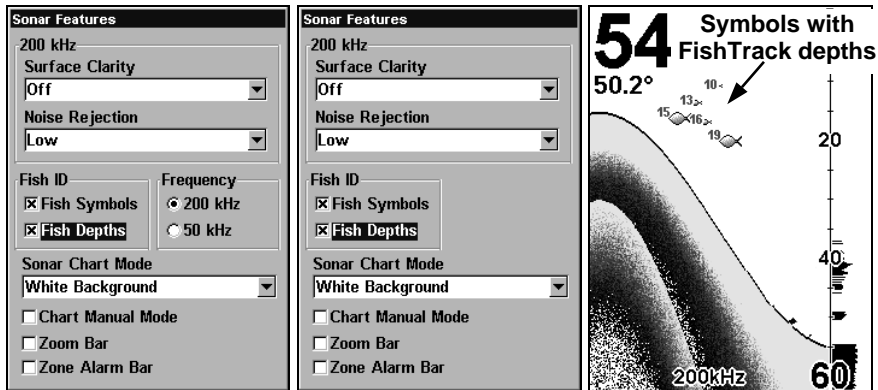

Sonar Features menu with Fish I.D. Depths selected (at left, dual-frequency menu; center, single-frequency menu). When the check box to the left is checked, the feature is on. At right, Sonar Page showing Fish I.D. symbols and FishTrack depths turned on.

Frequency (Change Transducer Frequency) (SeaFinder CDF only)

The SeaFinder CDF transducer operates with both 200 kHz and 50 kHz. The 200 kHz frequency has a 12° cone angle and the 50 kHz frequency has a 35° cone angle.

The default frequency is 200 kHz, which is best for use in shallow water (about 300 feet or less). This frequency is the best choice for about 80 percent of the fresh and salt water sport fishing applications. When you get into very deep salt water, 300 to 500 feet or deeper, the 50 kHz frequency is the best choice.

The 200 kHz transducer will give you better detail and definition, but less depth penetration. The 50 kHz transducer will give you greater depth penetration, but a little less detail and less definition. (Remember, all sonar units typically read deeper in fresh water than in salt water.)

There is a common exception to these rules of thumb. Some fishermen on freshwater lakes (or the ocean) using downriggers like to see them on the sonar. In many of those cases, you'll see a 50 kHz transducer frequency in use because the wider cone angle lets them watch the bait.

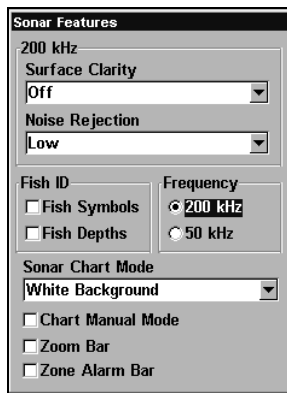

Sonar Features menu with a frequency of 200 kHz selected.

To change the frequency setting to 50 kHz:

1. From the Sonar Page, press **MENU** | ↓ to **SONAR FEATURES** | **ENT.**
2. Press ↓ to **FISH DEPTHS** | → to **50 kHz** | **ENT.**

3. Press **EXIT** | **EXIT** to clear the menu.

To change the frequency setting to 200 kHz:

1. From the Sonar Page, press **MENU** | ↓ to **SONAR FEATURES** | **ENT**.

2. Press ↓ to **FISH SYMBOLS** | → to **200 kHz** | **ENT**.

3. Press **EXIT** | **EXIT** to clear the menu.

HyperScroll™

See the entry on Ping Speed, which controls the HyperScroll feature.

Noise Rejection

See the entry on Advanced Signal Processing in this section.

Overlay Data

To change the digital data shown "floating" on top of the Sonar Page:

To select data for display:

1. Press **MENU** | ↓ to **OVERLAY DATA** | **ENT**.

2. Press ↓ or ↑ to select *Data Type* | **ENT**.

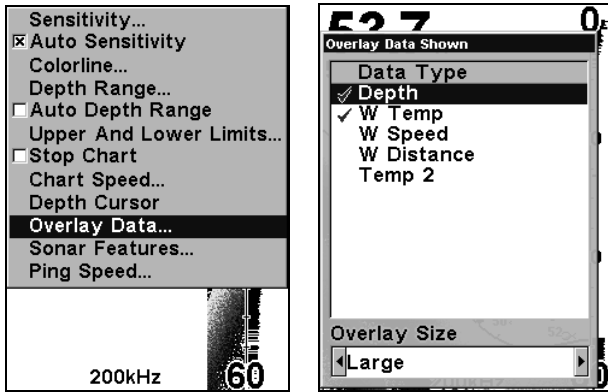

Overlay Data command on the Sonar Menu, at left. **Overlay Data Shown** selection menu, right. In this example, **Depth** will be displayed in a large font.

When selected, the data type shifts to the top of the data list and a check mark appears beside the data type. (If you wish, you may now use ↓ or ↑ to select other Data Types for display.)

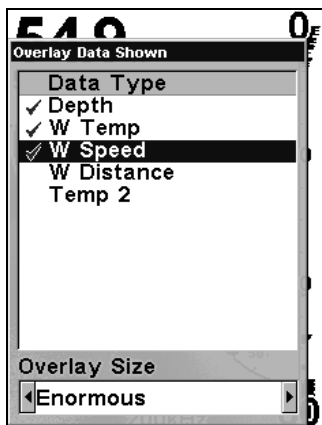

Data list showing Water Speed selected to display on Sonar Page.

3. To return to the previous page, press **EXIT**.

To turn off displayed data:

1. Press **MENU** | ↓ to **OVERLAY DATA** | **ENT**.
2. Press ↓ or ↑ to select *Data Type* | **ENT**. The selected data type disappears from the top of the list and reverts to its previous, unchecked position. (If you wish, you may now use ↓ or ↑ to select other Data Types to turn off.)
3. To return to the previous page, press **EXIT**.

To change displayed data font size:

1. Press **MENU** | ↓ to **OVERLAY DATA** | **ENT**.
2. Press ↓ or ↑ to select *Data Type* | press → or ← to *Data Size* | **EXIT**.

The selected data type will be displayed in the new size. (To change the font size for another Data Type, press **ENT** and repeat these steps, beginning with step two above.)

3. To return to the previous page, press **EXIT**.

Tip:

If you wish, you can change the displayed data font size when you select a data type:

1. From the Sonar page, press **MENU** | ↓ to **OVERLAY DATA** | **ENT**.
2. Press ↓ or ↑ to select *Data Type* | press → or ← to select *Data Size* | **ENT**.

The data will be shown in the new font size. To return to the previous page, press **EXIT**.

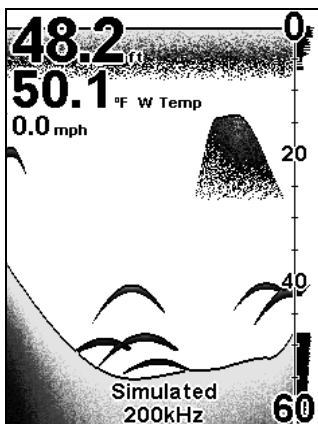

Sonar Page with Overlay Data turned on. This example shows Depth, Water Temperature and Water Speed.

NOTE:

Some data types can be displayed in only one font size. If that is the case, the Data Size box will not be displayed for that data type.

Ping Speed & HyperScroll™

Ping Speed controls the rate at which the transmitter and transducer broadcast sonar sound waves — pings — into the water. The unit has a default ping speed of 50 percent. At normal boating speeds, this auto-

matically provides enough return echoes to refresh the screen and scroll the chart at maximum chart speed.

However, when you are running at high speeds, or just want the fastest possible screen update, you may want to use the HyperScroll™ feature. When you change the Ping Speed to any setting greater than 50 percent, the unit automatically enters HyperScroll mode.

These faster ping rates allow you to maintain a high-detail picture on the screen, and the screen refresh rate and chart scroll speed can keep pace with the boat as it moves quickly over the bottom terrain.

When using HyperScroll, you may also need to manually decrease the sensitivity for optimum performance. Depending on water depth and other conditions, HyperScroll may cause a second bottom echo to return to the transducer during the next ping cycle, or sounding. This can result in a large amount of clutter appearing on the screen. If this occurs, just decrease the sensitivity to a level that eliminates the clutter. When you turn HyperScroll off, you can return to your original sensitivity level.

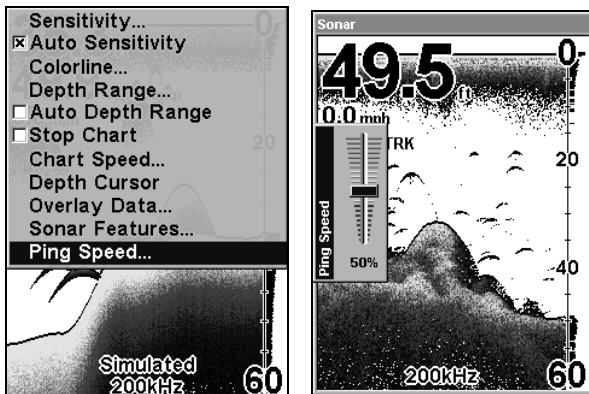

At left, Sonar Menu with Ping Speed command selected. Ping Speed Control Bar, right, at default setting.

To change Ping Speed:

1. From the Sonar Page, press **MENU** | ↓ to **PING SPEED** | **ENT**.
2. The Ping Speed Control Bar appears. Press ↑ to increase ping speed; press ↓ to decrease speed. When it's set at the desired level, press **EXIT**.

To adjust Sensitivity:

1. From the Sonar Page, press **MENU** | **ENT**.
2. The Sensitivity Control Bar appears. Press ↓ to decrease sensitivity; press ↑ to increase sensitivity. When it's set at the desired level, press **EXIT**. (When you reach the maximum or minimum limit, a tone sounds.)

To turn off HyperScroll:

1. From the Sonar Page, press **MENU** | ↓ to **PING SPEED** | **ENT**.
2. The Ping Speed Control Bar appears. Press ↓ to decrease ping speed to 50 percent. When it's set at the desired level, press **EXIT**.

When you boost ping speed and switch into HyperScroll, the width of the FasTrack bar graph display doubles in width at the right side of the screen. This allows you to better see the virtually instantaneous sonar returns, just as you would on a flasher sonar unit. For more information on FasTrack, see its entry in this section.

Pop-up Help

Help is available for virtually all of the menu labels on this unit. By highlighting a menu item and leaving it highlighted for a few seconds, a "pop-up" message appears that describes the function of the menu item. This feature is on by default.

To set up Popup Help: Press **MENU** | **MENU** | ↓ to **POPUP HELP**. With the option highlighted, press **ENT** to check it (turn on) and uncheck it (turn off). After the option is set, press **EXIT** to return to the page display.

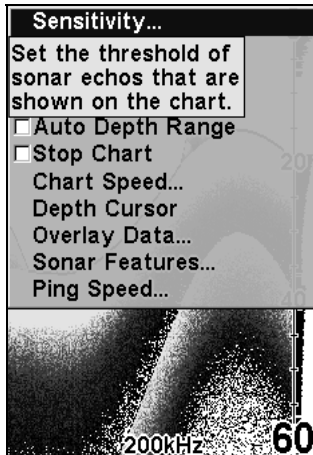

Example showing the Pop-up Help message for the Sensitivity command, located on the Sonar Menu.

Reset Options

This command is used to reset all features, options and settings to their original factory defaults. This is useful when you have changed several settings and want to return the unit to basic automatic operation.

1. Press **MENU | MENU | ↓** to **RESET OPTIONS | ENT**.
2. Press **←** to **YES | ENT**.
3. All the menus are cleared and the unit reverts to the full sonar chart, just as if you had turned it on for the first time. All options have been returned to the factory settings.

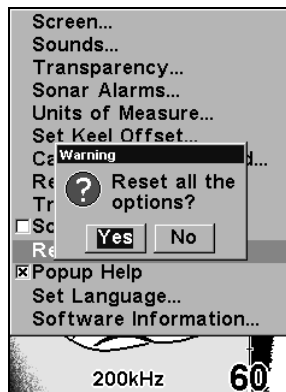
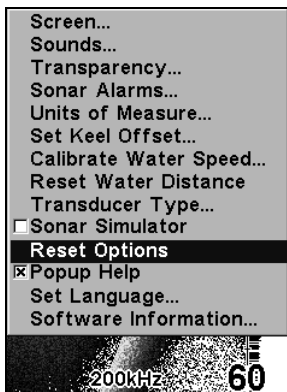

At left, Main Menu with Reset Options command selected. At right, the Reset Options dialog box, with "Yes" selected.

Reset Water Distance

The sonar chart's Digital Data display option includes a box that shows distance traveled, called Water Distance. This information is calculated from an optional water speed sensor. The Water Distance window can be reset to zero using the Reset Water Distance command.

Press **MENU|MENU|↓** to **RESET WATER DISTANCE|ENT**. The menus are cleared and the water distance is reset to 0.00.

Screen Contrast and Backlight Level

See the separate entries in this section for Contrast and Backlight Level.

Set Keel Offset

This unit measures water depth from the face of the transducer. Since the transducer is installed below the water surface, the distance displayed by the digital depth, chart depth scale, chart cursor or fish symbols is *not* the exact water depth. If the transducer is 1 foot below the

surface, and the screen shows the water depth as 30 feet, then the actual depth is 31 feet.

On sailboats or other large vessels with deep drafts, the distance between the transducer installation and the keel or lower engine unit can be several feet. In those cases, an inexact depth reading could result in grounding or striking underwater structure. The Keel Offset feature eliminates the need for the navigator to mentally calculate how much water is under his keel.

Keel Offset lets you calibrate the digital depth, chart depth scale, chart cursor depth and fish symbol depth displayed on the screen. To calibrate the depth indicators, first measure the distance from the face of the transducer to the lowest part of the boat. In this example, we will use 3.5 feet. This will be entered as a *negative* 3.5 feet, which makes the depth indicators perform as if the transducer's lower in the water than it really is.

1. Press **MENU | MENU | ↓** to **SET KEEL OFFSET | ENT**.
2. The Keel Offset dialog box appears. Press **↓** to change the plus (+) sign to a minus (-) sign.
3. Press **→** to the first number, then press **↑** to change the number to 3
4. Press **→** to the second number, then press **↑** to change the number to 5, then press **EXIT**. The depth indicators now accurately show the depth of water beneath the keel.

NOTE:

If knowing the exact depth of water beneath the keel is less important, you can calibrate the depth indicators so that they show the actual water depth from surface to bottom. To do this, first measure the distance from the face of the transducer up to the surface (the water line on the boat). In this example, we will use 1.5 feet. This will be entered as a *positive* 1.5 feet, which makes the depth indicators perform as if the transducer's higher in the water than it really is.

1. Press **MENU | MENU | ↓** to **SET KEEL OFFSET | ENT**.

2. The Keel Offset dialog box appears with a plus (+) sign at the front of the box.
3. Press → to the first number, then press ↑ to change the number to 1.
4. Press → to the second number, then press ↑ to change the number to 5, then press **EXIT**. The depth indicators now accurately show the water depth from surface to bottom.

Sensitivity & Auto Sensitivity

The sensitivity controls the ability of the unit to pick up echoes. Sensitivity can be adjusted, because water conditions vary greatly. A low sensitivity level (from zero to 50 percent) excludes much of the bottom information, fish signals, and other target information.

High sensitivity levels let you see this detail, but it can also clutter the screen with many undesired signals. Typically, the best sensitivity level shows a good solid bottom signal with Grayline® and some surface clutter.

Automatic Sensitivity

The default sensitivity mode is automatic. The unit bases the sensitivity level on water depth and conditions. When the unit is in the automatic mode, sensitivity is automatically adjusted to keep a solid bottom signal displayed, plus a little more power. This gives it the capability to show fish and other detail.

However, situations occur when it becomes necessary to increase or decrease the sensitivity. This typically happens when you wish to see more detail, so an increase in sensitivity is indicated. Or, wave action and boat wakes can create enough tiny air bubbles to clutter much of the water column. In that case, a decrease in sensitivity is indicated to reduce some of the clutter.

The control bar used to adjust sensitivity up or down is the same whether the unit is in the automatic or manual mode. In automatic you

can adjust sensitivity up to 100 percent but the unit will limit your *minimum* setting. In auto, the unit will continue to make small adjustments, allowing for the setting you selected.

In manual mode, you have *complete* control over sensitivity, with the ability to set it anywhere from zero to 100 percent. Once you select a level in manual, the unit will continue to use that exact sensitivity setting until you change it or revert to auto mode.

To adjust sensitivity in auto mode:

1. Press **MENU | ENT**.
2. The Sensitivity Control Bar appears. Press ↓ to decrease sensitivity; press ↑ to increase sensitivity. When it's set at the desired level, press **EXIT**. (When you reach the maximum or minimum limit, a tone sounds.)

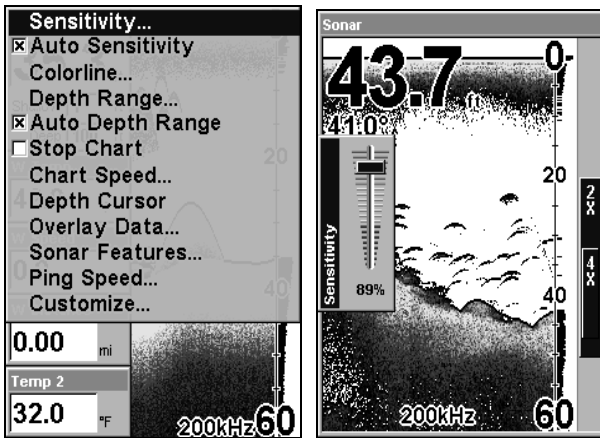

At left, Sonar Menu with Sensitivity command selected. At right, the Sensitivity Control Bar.

To adjust sensitivity in manual mode:

1. First, turn off Auto Sensitivity: from the Sonar Page, press **MENU** | ↓ to **AUTO SENSITIVITY** | **ENT**.
2. Press ↑ to **SENSITIVITY** | **ENT** and the Sensitivity Control Bar appears. Press ↓ or ↑ to pick a different sensitivity setting. When it's set at the desired level, press **EXIT**.

To turn Auto Sensitivity back on:

From the Sonar Page, press **MENU** | ↓ to **AUTO SENSITIVITY** | **ENT** | **EXIT**.

NOTE:

To return to the original factory setting for Auto Sensitivity, see the entry in this section on Reset Options. If sensitivity is in manual mode, the Reset Options command will switch back to Auto mode.

Tip:

For quicker sensitivity adjustments, try leaving the Sensitivity Control Bar on the screen as the chart scrolls. You can see the changes on the screen as you press the up or down arrows.

Set Language

This unit's menus are available in 10 languages: English, French, German, Spanish, Italian, Danish, Swedish, Russian, Dutch and Finnish. To select a different language:

1. Press **MENU** | **MENU** | ↓ to **SET LANGUAGE** | **ENT**.
2. Use ↓ or ↑ to select a different language and press **ENT**. All menus now appear in the language you selected.

Software Version Information

From time to time, Lowrance updates the operating system software in some of its products. These software upgrades are usually offered to customers as free downloads from our web site, www.lowrance.com. These upgrades make the unit perform better or introduce a new feature or function. You can find out what software version is running in your sonar unit by using the Software Information command.

1. Press **MENU | MENU | ↓** to **SOFTWARE INFO | ENT.**
2. Read the information displayed on the screen.
3. To return to the last page displayed, press **EXIT|EXIT.**

Sonar Chart Mode

The default color scheme for the sonar chart is white background, but we offer other variations to suit your viewing preferences. You can select the chart to be displayed in grayscale, reverse grayscale, blue background, Nightview, IceView, or bottom color tracking.

To change the chart mode color scheme:

1. From the Sonar Page, press **MENU | ↓** to **SONAR FEATURES | ENT.**
2. Press **↓** to **SONAR CHART MODE | ENT.**
3. Press **↓** or **↑** to *Mode Name* | **ENT.**
4. Press **EXIT | EXIT** to return to the Sonar Page.

Sonar Page & Sonar Chart Display Options

The Pages Menu offers three chart display options. To access them, press **PAGES ↑** or **↓** to *Option Name* | **EXIT.**

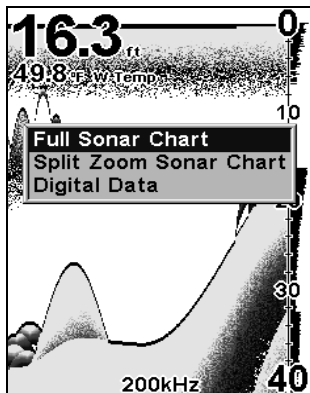

Pages Menu, showing sonar chart display options.

Full Sonar Chart

This is the default mode used when the unit is turned on for the first time or when it's reset to the factory defaults.

The bottom signal scrolls across the screen from right to left. Depth scales on the right side of the screen aid in determining the depth of targets. The line at the top of the screen represents the surface. The bottom depth and surface temperature (if equipped with a temperature sensor or a transducer with a temp sensor built in) show at the top left corner of the screen.

The FasTrack™ display shows just to the right of the scale. This changes all echoes into short horizontal bars, replicating a flasher sonar. The zoom bar on the far right shows the area that's zoomed when the zoom is in use. (See the Zoom section for more information.)

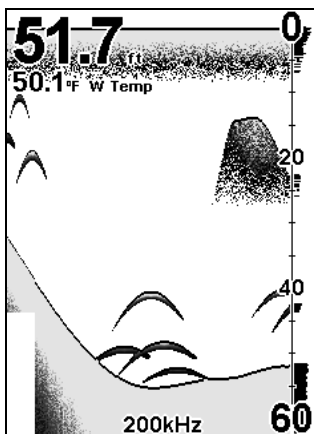

Full Sonar Chart. The Overlay Data (depth and water temperature) are set to different text sizes.

Split Zoom Sonar Chart

A split chart shows the underwater world from the surface to the bottom on the right side of the screen. The left side shows an enlarged version of the right side. The zoom range shows at the bottom left corner of the screen.

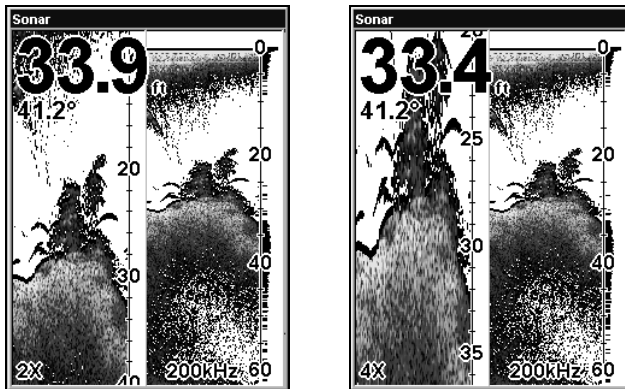

Split Zoom Sonar Chart. Image at left shows the left window zoomed to 2X. The right image shows the left window zoomed to 4X.

Digital Data/Chart

This mode shows the chart on the right side of the screen. The left side has five large digital data boxes or windows containing (by default): Water Depth; Water Temperature; Water Speed (from an optional speed sensor) and Water Distance (distance traveled or log, it also requires a speed sensor).

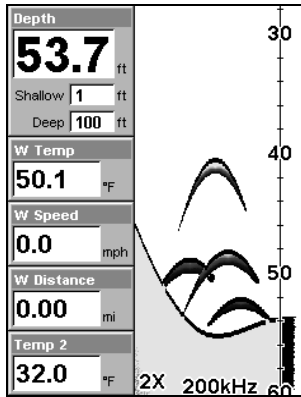

Digital Data/Chart

Customizing the Digital Data/Chart Screen

The Digital Data/Chart screen can be customized to show digital data different from the defaults first shown. To customize this screen:

1. From the Sonar Page (in Digital Data mode), press **MENU** | ↓ to **CUSTOMIZE** | **ENT**.

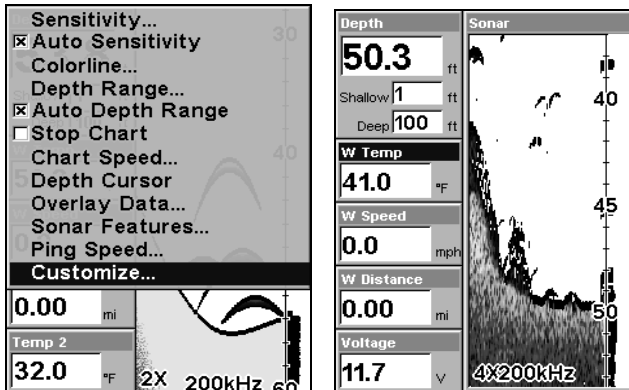

At left, the Sonar Menu showing the Customize command highlighted.

At right, the Water Temperature box is selected.

2. The Water Temperature box title bar flashes, indicating the box contents can be changed. Press **ENT** | \uparrow or \downarrow to select *data type* | **ENT** | **EXIT**.

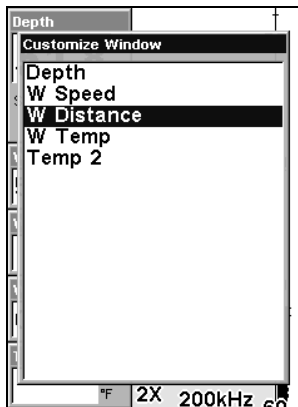

Water Distance has been picked to replace Water Temperature in the top digital data box.

Tip:

You can customize other digital data boxes before returning to the Sonar Page. After changing the first box by selecting the Data Type and pressing Enter, use the \downarrow key to select another box to change. When the selected box title bar flashes, press **ENT** | \uparrow or \downarrow to select *data type* | **ENT**. Repeat these steps until you're finished customizing, then press **EXIT** to return to the Sonar Page.

Sonar Simulator

This unit has a built-in simulator that lets you run it as if you were on the water. All sonar features and functions are useable. When in simulator mode, the unit periodically will display "Simulated" at the bottom of the Sonar Page. To use the simulator:

1. From the Sonar Page, press **MENU** | **MENU** | \downarrow to **SONAR SIMULATOR** | **ENT**.

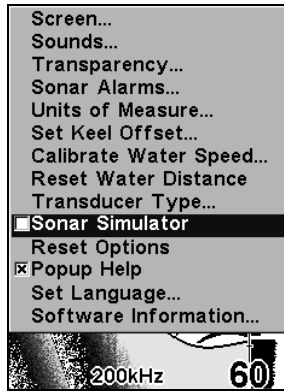

**Main Menu with Sonar Simulator command selected.
The Simulator is turned off (checkbox is unchecked).**

NOTE:

If you turn on your unit before attaching a transducer, it may enter a demo mode. The words "demo mode" flash on the bottom of the screen and a sonar chart plays much like the simulator. Unlike the simulator, the demo mode is for demonstration only, and will automatically stop as soon as you turn on the unit with a transducer attached. The simulator will continue to function normally.

Stop Chart

If you are running multiple units on a boat or using this unit in a car, there are times when you may want to turn off the sonar. This command turns off the sonar and stops the chart from scrolling. Sonar restarts automatically each time you turn on your unit.

Press **MENU** | ↓ to **STOP CHART** | **ENT** | **EXIT**.

To turn on sonar and start the chart scrolling again, repeat the above step.

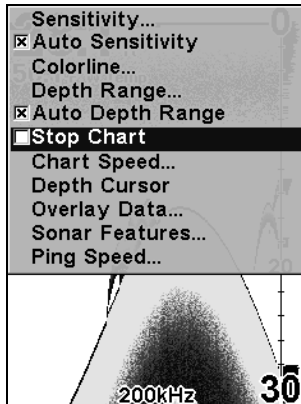

Sonar Menu with Stop Chart command selected. The box is unchecked, indicating that the chart is scrolling across the screen.

Surface Clarity

The markings extending downward from the zero line on the chart are called "surface clutter." These markings are caused by wave action, boat wakes, temperature inversion and more.

The surface clarity control reduces or eliminates surface clutter signals from the display. It does this by changing the sensitivity of the receiver, decreasing it near the surface and gradually increasing it as the depth increases.

There are three levels of surface clarity available: low, medium, or high. It can also be turned off. The default level is off.

To adjust the Surface Clarity level:

1. From the Sonar Page, press **MENU** | **↓** to **SONAR FEATURES** | **ENT** | **ENT**.

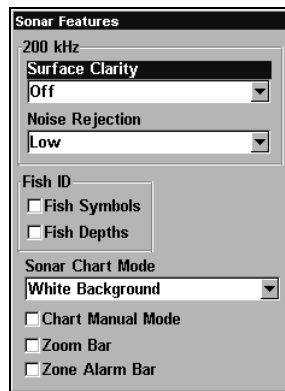
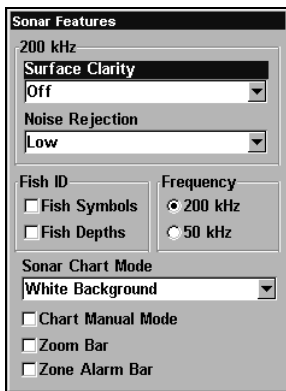

Sonar Features menu with Surface Clarity selected (at left, dual-frequency menu; at right, single-frequency menu).

2. Press ↓ or ↑ to select *clarity level* | EXIT | EXIT.

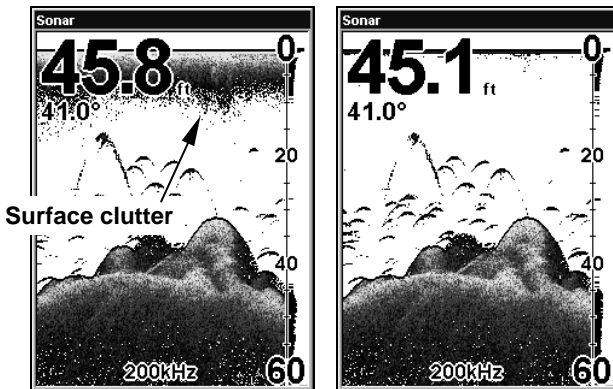

In the illustration at left, Surface Clarity is turned off.
The right view shows Surface Clarity set at High.

Transparency

Use the transparency menu to adjust the transparency of menu windows. A high transparency allows you to continue monitoring the sonar chart while adjusting feature settings, though the text of the menus may fade until it is unreadable. A low transparency will usually make menu text easier to read, at the cost of watching your sonar returns.

Experiment with this feature until you find the right level of transparency for your eyes.

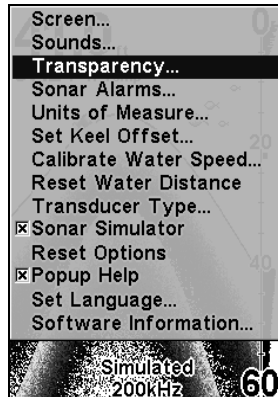

Main Menu with Transparency command selected.

To adjust Menu Transparency level:

Press **MENU | MENU | ↓** to **TRANSPARENCY | ENT**. The **TRANSPARENCY** slider bar appears. Press **↑** or **↓** to move the bar. The lower end of the scale makes the menu opaque; the upper end is maximum transparency.

Units of Measure

This menu sets the speed and distance (statute or nautical miles, meters), depth (feet, fathoms, or meters) and temperature (degrees Fahrenheit or Celsius). To change the units:

Press **MENU | MENU | ↓** to **UNITS OF MEASURE | ENT**.

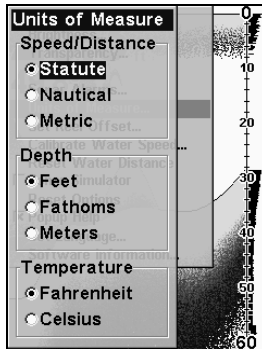

The Units of Measure Menu.

To set Units of Measure: Press ↓ to the desired units, then press **ENT**. After all the options are set as desired, press **EXIT|EXIT** to return to the page display.

Volume

This command adjusts the speaker volume, which controls the sound levels for keystrokes and alarms. If you want to turn off all sounds, set the volume to zero.

To adjust volume:

1. Press **MENU | MENU | ↓** to **VOLUME | ENT**.
2. The Volume Control Bar appears. Press ↓ to decrease the volume; press ↑ to increase the volume. When it's set at the desired level, press **EXIT**.

Zoom & Zoom Bar

"Zooming" the display is a common, fast and easy method used to enlarge small detail, fish signals and the bottom with its associated structure. This unit lets you zoom the display quickly and easily by pressing the Zoom In key, **ZIN**.

Pressing **ZIN** once doubles the size (2X) of all echoes on the screen. Pressing it again quadruples the size (4X). Press the Zoom Out key, **ZOUT**, to return the display to the normal mode.

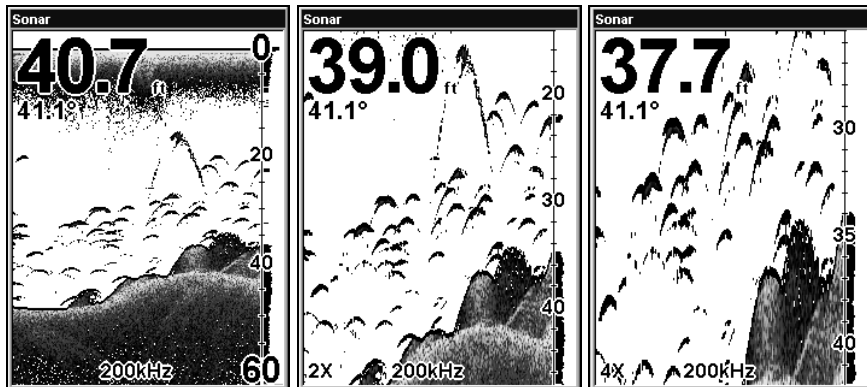

At left, Sonar Page, normal view. Center, same view zoomed to 2X. Right, same view zoomed to 4X

Zoom Pan

Your unit has the handy ability to quickly zoom in on any portion of the water column with just the touch of an arrow key. The Zoom Pan feature lets you rapidly move the zoomed area up and down to different depths. By "pointing" your zoom at different portions of the chart as it scrolls, you can get a good, close-up look at structure or cover below you.

To use Zoom Pan, switch to a manual depth Range setting (see page 64) and turn on 2X or 4X Zoom. Then, simply press \uparrow or \downarrow to pan up and down the water column.

Section 5: Troubleshooting

If your unit is not working, or if you need technical help, please use the following troubleshooting section before contacting the factory customer service department. It may save you the trouble of returning your unit for repair. For contact information, refer to the last page, just inside the back cover of this manual.

Unit won't turn on:

1. Check the power cable's connection at the unit. Also check the wiring.
2. Make certain the power cable is wired properly. The red wire connects to the positive battery terminal, black to negative or ground.
3. Check the fuse.
4. Measure the battery voltage at the unit's power connector. It should be at least 11 volts. If it isn't, the wiring to the unit is defective, the battery terminals or wiring on the terminals are corroded, or the battery needs charging.

Unit operates only in demo mode:

1. The transducer has not yet been connected or has been disconnected. To leave demo mode, make sure the transducer is securely connected before turning the unit on.

Unit freezes, locks up, or operates erratically:

1. Electrical noise from the boat's motor, trolling motor, or an accessory may be interfering with the sonar unit. Rerouting the power and transducer cables away from other electrical wiring on the boat may help. Route the sonar unit's power cable directly to the battery instead of through a fuse block or ignition switch.
2. Inspect the transducer cable for breaks, cuts, or pinched wires.
3. Check both the transducer and power connectors. Make certain both are securely plugged in to the unit.

Weak bottom echo, digital readings erratic, or no fish signals:

1. Make sure the transducer is pointing straight down. Clean the face of the transducer. Oil, dirt and fuel can cause a film to form on the transducer, reducing its effectiveness. If the transducer is mounted inside the hull, be sure it is shooting through only one layer of fiberglass and that it is securely bonded to the hull. When attaching a transducer to the inside of a hull, **ONLY** use the epoxy available from LEI (order information is inside the back cover). Do **NOT** use RTV silicone rubber adhesive or any other type of epoxy. The LEI epoxy is specially formulated so that it will cure properly for shoot-through applications.

2. Electrical noise from the boat's motor can interfere with the sonar. This causes the sonar to automatically increase its Discrimination or noise rejection feature. This can cause the unit to eliminate weaker signals such as fish or even structure from the display.

3. The water may be deeper than the sonar's ability to find the bottom. If the sonar can't find the bottom signal while it's in the automatic mode, the digital sonar display will flash continuously. It may change the range to limits far greater than the water you are in. If this happens, place the unit in the manual mode, then change the range to a realistic one, (for example, 0-100 feet) and increase the sensitivity. As you move into shallower water, a bottom signal should appear.

4. Check the battery voltage. If the voltage drops, the unit's transmitter power also drops, reducing its ability to find the bottom or targets.

Bottom echo disappears at high speeds or erratic digital reading or weak bottom echo while boat is moving

1. The transducer may be in turbulent water. It must be mounted in a smooth flow of water in order for the sonar to work at all boat speeds. Air bubbles in the water disrupt the sonar signals, interfering with its ability to find the bottom or other targets. The technical term for this is cavitation.

2. Electrical noise from the boat's motor can interfere with the sonar. This causes the sonar to automatically increase its Discrimination or noise rejection feature. This can cause the unit to eliminate weaker signals such as fish or even structure from the display. Try using resistor spark plugs or routing the sonar unit's power and transducer cables away from other electrical wiring on the boat.

No fish arches when the Fish I.D. feature is off:

1. Make certain the transducer is pointing straight down. This is the most common problem if a partial arch is displayed.

2. The sensitivity may not be high enough. In order for the unit to display a fish arch, it has to be able to receive the fish's echo from the time it enters the cone until it leaves. If the sensitivity is not high enough, the unit shows the fish only when it is in the center of the cone.

3. Use the Zoom feature. It is much easier to display fish arches when zoomed in on a small range of water than a large one. For example, you will have much better luck seeing fish arches with a 30 to 60 foot range than a 0 to 60 foot range. This enlarges the targets, allowing the display to show much more detail.

4. The boat must be moving at a slow trolling speed to see fish arches. If the boat is motionless, fish stay in the cone, showing on the screen as straight horizontal lines.

Noise

A major cause of sonar problems is electrical noise. This usually appears on the sonar's display as random patterns of dots or lines. In severe cases, it can completely cover the screen with black dots, or cause the unit to operate erratically, or not at all.

To eliminate or minimize the effects of electrical noise, first try to determine the cause. With the boat at rest in the water, the first thing you should do is turn all electrical equipment on the boat off. Make sure the engine is also off. Turn your sonar on, then turn off Noise Reject [also known as the ASP feature (Advanced Signal Processing)]. Sensi-

tivity should be set at 90-95 percent. There should be a steady bottom signal on the display. Now turn on each piece of electrical equipment on the boat and view the effect on the sonar's display. For example, turn on the bilge pump and view the sonar display for noise. If no noise is present, turn the pump off, then turn on the VHF radio and transmit. Keep doing this until all electrical equipment has been turned on, their effect on the sonar display noted, then turned off.

If you find noise interference from an electrical instrument, trolling motor, pump, or radio, try to isolate the problem. You can usually reroute the sonar unit's power cable and transducer cable away from the wiring that is causing the interference. VHF radio antenna cables radiate noise when transmitting, so be certain to keep the sonar's wires away from it. You may need to route the sonar unit's power cable directly to the battery to isolate it from other wiring on the boat.

If no noise displays on the sonar unit from electrical equipment, then make certain everything except the sonar unit is turned off, then start the engine. Increase the RPM with the gearshift in neutral. If noise appears on the display, the problem could be one of three things; spark plugs, alternator, or tachometer wiring. Try using resistor spark plugs, alternator filters, or routing the sonar unit's power cable away from engine wiring. Again, routing the power cable directly to the battery helps eliminate noise problems. Make certain to use the in-line fuse supplied with the unit when wiring the power cable to the battery.

When no noise appears on the sonar unit after all of the above tests, then the noise source is probably cavitation. Many novices or persons with limited experience make hasty sonar installations which function perfectly in shallow water, or when the boat is at rest. In nearly all cases, the cause of the malfunction will be the location and/or angle of the transducer. The face of the transducer must be placed in a location that has a smooth flow of water at all boat speeds. Read your transducer owner's manual for the best mounting position.

Section 6: Supplemental Material

FCC Compliance

This device complies with Part 15 of the U.S. Federal Communications Commission (FCC) Rules. Operation is subject to the following two conditions: (1) this device may not cause harmful interference, and (2) this device must accept any interference received, including interference that may cause undesired operation.

Changes or modifications not expressly approved by the manufacturer could void the user's authority to operate the equipment.

Note:

This equipment has been tested and found to comply with the limits for a Class B digital device, pursuant to Part 15 of the FCC Rules. These limits are designed to provide reasonable protection against harmful interference in a residential installation. This equipment generates, uses and can radiate radio frequency energy and, if not installed and used in accordance with the instructions, may cause harmful interference to radio communications. However, there is no guarantee that interference will not occur in a particular installation. If this equipment does cause harmful interference to radio or television reception, which can be determined by turning the equipment off and on, the user is encouraged to try to correct the interference by one or more of the following measures:

Reorient or relocate the receiving antenna.

Increase the separation between the equipment and receiver.

Connect the equipment into an outlet on a circuit different from that to which the receiver is connected.

Consult the factory customer service department for help.

Notes

Index

- A**
Accessories, 1, 31; **Sec. 2, Installation & Accessories**, 7
Alarms, 38, 40, 54, 55, 56, 57, 58; Depth Alarms, 55; Fish Alarm, 54, 57, 58; Zone Alarm, 54, 56, 57
Antenna, 96, 97
ASP™ (Advanced Signal Processing), 23, 53
- B**
Backlights / Lighting, 2, 38, 58, 59, 77
Batteries, 7, 29, 30, 34, 35, 93, 94, 96
Brightness, 39
- C**
Calibrate Speed, 59
Chart Speed, 60, 61
Contrast, 39, 63, 77
Cursor, 5, 38, 45, 56, 60, 63, 77, 78
Customize Display, 84, 86
- D**
Data Boxes (Customize Display), 84, 86
Depth Cursor, 5, 45, 63
Depth Range, 4, 23, 57, 64, 65, 84, 92, 94, 95; Automatic, 64; Manual, 64
Display Options, 38, 49, 82, 83, 84, 85
- F**
FasTrack™, 65
Fish Depths, 67
Fish I.D.™, 50, 54, 57, 66
Fish Symbols, 50, 54, 57, 66, 70; Interpreting, 50
FishTrack™, 67
Frequency, 3, 68; Change Frequency, 68
- G**
Grayline®, 79
- H**
HyperScroll™, 70, 73, 74
- I**
Icons, 5
Information Displays (Customize Display), 84, 86
Installation, 7, 24, 27, 31, 32, 33, 34, 35; **Sec. 2, Installation & Accessories**, 7
Introduction: **Sec. 1, Introduction**, 1; Specifications, 2
- K**
Keel Offset, 40, 77, 78

Keyboard, 5, 37, 51
Keypad Description, 38

L
Languages, 3, 40, 81

M
Main Menu, 37, 39, 55, 77, 87,
90

N
Noise Rejection, 54, 70

O
Overlay Data, 70, 71, 72, 73, 83

P
Page Displays, 40, 41, 82;
Digital Data, 38, 77, 84, 85
Ping Speed, 70, 73, 74, 75;
HyperScroll™, 70, 73, 74
Pop-up Help, 75, 76
Power, 1, 2, 7, 29, 30, 31, 32,
34, 35, 38, 45, 79, 93, 94, 95,
96

Product Specifications, 2

R
Range, 4, 23, 57, 64, 65, 84, 92,
94, 95; Automatic, 64;
Manual, 64
Repeat Play List, 86
Reset Options, 40, 49, 76, 77, 81
Reset Water Distance, 40, 77
Route, 7, 8, 10, 17, 18, 19, 26,
29, 93, 96

S
Sensitivity, 23, 45, 46, 47, 48,
49, 75, 76, 79, 80, 81, 96
Simulator, 40, 86, 87
Software Version Information,
81
Sonar Chart Color Mode, 82
Sonar Chart Display Options,
38, 49, 82, 83, 84, 85
Sonar Menu, 49, 54, 71, 74, 76,
80, 85, 88
Sonar Operation: Quick
Reference, 45
Speaker, 91
Speed Sensors, 4, 26, 27, 28, 29,
59, 77, 84
Stop Chart, 87, 88
Surface Clarity, 88, 89

T
Temperature Sensors, 8, 12, 26,
27, 83
Text Boxes (Customize
Display), 84, 86
Transducer, 1, 3, 4, 7, 8, 9, 10,
11, 12, 13, 14, 15, 16, 17, 18,
19, 20, 21, 22, 23, 24, 25, 26,
27, 31, 32, 34, 40, 45, 46, 53,
65, 68, 69, 73, 74, 77, 78, 83,
87, 93, 94, 95, 96; Mounting,
12, 19; Shoot-Thru-Hull, 11,
22, 24
Transducer Type, 40

U

Units of Measure, 40, 90, 91

Utilities, 37

Z

Zooming, 3, 38, 45, 83, 91, 92,
95; Zoom Bar, 91; Zoom Pan,
92

Notes

EAGLE ELECTRONICS FULL ONE-YEAR WARRANTY

"We," "our," or "us" refers to EAGLE ELECTRONICS, a division of LEI, the manufacturer of this product. "You" or "your" refers to the first person who purchases this product as a consumer item for personal, family, or household use.

We warrant this product against defects or malfunctions in materials and workmanship, and against failure to conform to this product's written specifications, all for one (1) year from the date of original purchase by you. **WE MAKE NO OTHER EXPRESS WARRANTY OR REPRESENTATION OF ANY KIND WHATSOEVER CONCERNING THIS PRODUCT.** Your remedies under this warranty will be available so long as you can show in a reasonable manner that any defect or malfunction in materials or workmanship, or any non-conformity with the product's written specifications, occurred within one year from the date of your original purchase, which must be substantiated by a dated sales receipt or sales slip. Any such defect, malfunction, or non-conformity which occurs within one year from your original purchase date will either be repaired without charge or be replaced with a new product identical or reasonably equivalent to this product, at our option, within a reasonable time after our receipt of the product. If such defect, malfunction, or non-conformity remains after a reasonable number of attempts to repair by us, you may elect to obtain without charge a replacement of the product or a refund for the product. **THIS REPAIR, OR REPLACEMENT OR REFUND (AS JUST DESCRIBED) IS THE EXCLUSIVE REMEDY AVAILABLE TO YOU AGAINST US FOR ANY DEFECT, MALFUNCTION, OR NON-CONFORMITY CONCERNING THE PRODUCT OR FOR ANY LOSS OR DAMAGE RESULTING FROM ANY OTHER CAUSE WHATSOEVER. WE WILL NOT UNDER ANY CIRCUMSTANCES BE LIABLE TO ANYONE FOR ANY SPECIAL, CONSEQUENTIAL, INCIDENTAL, OR OTHER INDIRECT DAMAGE OF ANY KIND.**

Some states do not allow the exclusion or limitation of incidental or consequential damages, so the above limitations or exclusions may not apply to you.

This warranty does NOT apply in the following circumstances: (1) when the product has been serviced or repaired by anyone other than us; (2) when the product has been connected, installed, combined, altered, adjusted, or handled in a manner other than according to the instructions furnished with the product; (3) when any serial number has been effaced, altered, or removed; or (4) when any defect, problem, loss, or damage has resulted from any accident, misuse, negligence, or carelessness, or from any failure to provide reasonable and necessary maintenance in accordance with the instructions of the owner's manual for the product.

We reserve the right to make changes or improvements in our products from time to time without incurring the obligation to install such improvements or changes on equipment or items previously manufactured.

This warranty gives you specific legal rights and you may also have other rights which may vary from state to state.

REMINDER: You must retain the sales slip or sales receipt proving the date of your original purchase in case warranty service is ever required.

**EAGLE ELECTRONICS
PO BOX 669, CATOOSA, OK 74015
(800) 324-1354**

How to Obtain Service...

...in the USA:

We back your investment in quality products with quick, expert service and genuine Eagle replacement parts. If you're in the United States and you have technical, return or repair questions, please contact the Factory Customer Service Department. Before any product can be returned, you must call customer service to determine if a return is necessary. Many times, customer service can resolve your problem over the phone without sending your product to the factory. To call us, use the following toll-free number:

800-324-1354

8 a.m. to 5 p.m. Central Standard Time, M-F

Eagle Electronics may find it necessary to change or end our shipping policies, regulations, and special offers at any time. We reserve the right to do so without notice.

...in Canada:

If you're in Canada and you have technical, return or repair questions, please contact the Factory Customer Service Department. Before any product can be returned, you must call customer service to determine if a return is necessary. Many times, customer service can resolve your problem over the phone without sending your product to the factory. To call us, use the following toll-free number:

800-661-3983

905-629-1614 (not toll-free)

8 a.m. to 5 p.m. Eastern Standard Time, M-F

...outside Canada and the USA:

If you have technical, return or repair questions, contact the dealer in the country where you purchased your unit. To locate an Eagle dealer near you, visit our web site, and look for the Dealer Locator (www.eaglesonar.com/Products/HowToBuy/dealers.asp). Or, you can consult your telephone directory for listings.

Accessory Ordering Information for all countries

To order Eagle accessories such as power cables or transducers, please contact:

1) Your local marine dealer or consumer electronics store. Most quality dealers that handle marine electronic equipment or other consumer electronics should be able to assist you with these items.

To locate an Eagle dealer near you, visit our web site, and look for the Dealer Locator (www.eaglesonar.com/Products/HowToBuy/dealers.asp). Or, you can consult your telephone directory for listings.

2) U.S. customers: LEI Extras Inc., PO Box 129, Catoosa, OK 74015-0129

Call 1-800-324-0045 or visit our web site www.lei-extras.com.

3) Canadian customers can write:

Lowrance/Eagle Canada, 919 Matheson Blvd. E. Mississauga, Ontario L4W2R7
or fax 905-629-3118.

Shipping Information

If it becomes necessary to send a product for repair or replacement, you must first receive a return authorization number from Customer Service. Products shipped without a return authorization will not be accepted. When shipping, we recommend you do the following:

1. Please do not ship the knobs or mounting bracket with your unit.
2. If you are sending a check for repair, please place your check in an envelope and tape it to the unit.
3. For proper testing, include a brief note with the product describing the problem. Be sure to include your name, return shipping address and a daytime telephone number. An e-mail address is optional but useful.
4. Pack the unit in a suitable size box with packing material to prevent any damage during shipping.
5. Write the Return Authorization (RA) number on the outside of the box underneath your return address.
6. For your security, you may want to insure the package through your shipping courier. Eagle does not assume responsibility for goods lost or damaged in transit.

Visit our web site:



www.eaglesonar.com



Successful Fishing Made Simple™

Eagle Pub. 988-0156-031

Printed in USA 112404

Copyright © 2004
All Rights Reserved
LEI-Eagle

Free Manuals Download Website

<http://myh66.com>

<http://usermanuals.us>

<http://www.somanuals.com>

<http://www.4manuals.cc>

<http://www.manual-lib.com>

<http://www.404manual.com>

<http://www.luxmanual.com>

<http://aubethermostatmanual.com>

Golf course search by state

<http://golfingnear.com>

Email search by domain

<http://emailbydomain.com>

Auto manuals search

<http://auto.somanuals.com>

TV manuals search

<http://tv.somanuals.com>