

# FISH I.D. II

## INSTALLATION AND OPERATION INSTRUCTIONS



LITHO IN U.S.A.

988-0106-34 Rev. C

## TABLE OF CONTENTS

INTRODUCTION .....	4
INSTALLATION .....	4
POWER CONNECTIONS.....	5
KEYBOARD BASICS .....	6
OPERATION .....	8
SENSITIVITY .....	8
CHART SPEED .....	10
RANGE .....	11
ZOOM .....	11
DIGITAL .....	12
FISH ID FEATURE .....	13
AUTO .....	14
ALARMS .....	14
CHART ALARM .....	15
FISH ALARM .....	16
SPEAKER .....	16
LIGHT .....	16
MODE .....	17
TRANSDUCERS AND CONE ANGLES .....	19
SIGNAL INTERPRETATION .....	20
FISH ARCHES .....	21
WATER TEMPERATURE AND THERMOCLINES .....	22
SURVEYING A LAKE .....	24
BAIT FISH .....	24
SPECIFICATIONS .....	25
TROUBLESHOOTING .....	26
SIMULATOR .....	29

Copyright © 1990, Eagle Electronics.  
All rights reserved.

All features and specifications subject to change without notice.  
All screens and illustrations in this manual are simulated.

to 60 foot range than a 0 to 60 foot range. This enlarges the targets, allowing the display to show much more detail.

- The boat must be moving at a slow trolling speed to see fish arches. If the boat is motionless, fish stay in the cone, showing on the display as straight horizontal lines.

## ELECTRICAL NOISE

A major cause of sonar problems is electrical noise. This usually appears on the sonar's display as random patterns of dots or lines. In severe cases, it can completely cover the screen with black dots, or cause the unit to operate erratically, or not at all.

To eliminate or minimize the effects of electrical noise, first try to determine the cause. With the boat at rest in the water, the first thing you should do is turn all electrical equipment on the boat off. Make certain the engine is off, also. Turn on your sonar unit. There should be a steady bottom signal on the display. Now turn on each piece of electrical equipment on the boat and view the effect on the sonar's display. For example, turn on the bilge pump, view the sonar display for noise. If no noise is present, turn the pump off, then turn on and use the VHF radio. Keep doing this until all electrical equipment has been turned on, their effect on the sonar display noted, then turned off.

If you find noise interference from an electrical instrument, trolling motor, pump, or radio, try to isolate the problem. You can usually route the sonar unit's power cable and transducer cable away from the wiring that is causing the interference. VHF radio antenna cables radiate noise when transmitting, so be certain to keep the sonar's wires away from it. You may need to route the sonar unit's power cable directly to the battery to isolate it from other wiring on the boat.

If no noise displays on the sonar unit from electrical equipment, then make certain everything except the sonar unit is turned off, then start the engine. Increase the RPM with the gearshift in neutral. If noise appears on the display, the problem could be one of three things: spark plugs, alternator, or tachometer wiring. Try using resistor spark plugs, alternator filters, or routing the sonar unit's power cable away from engine wiring. Again, routing the power cable directly to the battery helps eliminate noise problems. Make certain to use the in-line fuse supplied with the unit when wiring the power cable to the battery.

## Power Connections

The Fish I.D. II operates from a 12 volt battery system. Attach the power cable to an accessory or power buss. If you have problems with electrical interference, then attach the cable directly to the battery. Electrical interference shows as random dots on the display whenever the boat's engine or an accessory is on.

The power cable has two wires, red is the positive lead and black is negative or ground. Attach the in-line fuse holder to the red wire on the power cable with the crimp connector. The other end of the fuse holder attaches to the battery or accessory buss. If the cable is not long enough, splice ordinary #18 gauge wire onto it. Be certain that the fuse holder is as close to the power source (battery or accessory buss) as possible. This protects the power cable and your unit in the event of a short. Use a 3-amp fuse.

These units have reverse polarity protection. No damage will occur if the power wires are reversed. (However, the unit will not work until the wires are attached correctly.)

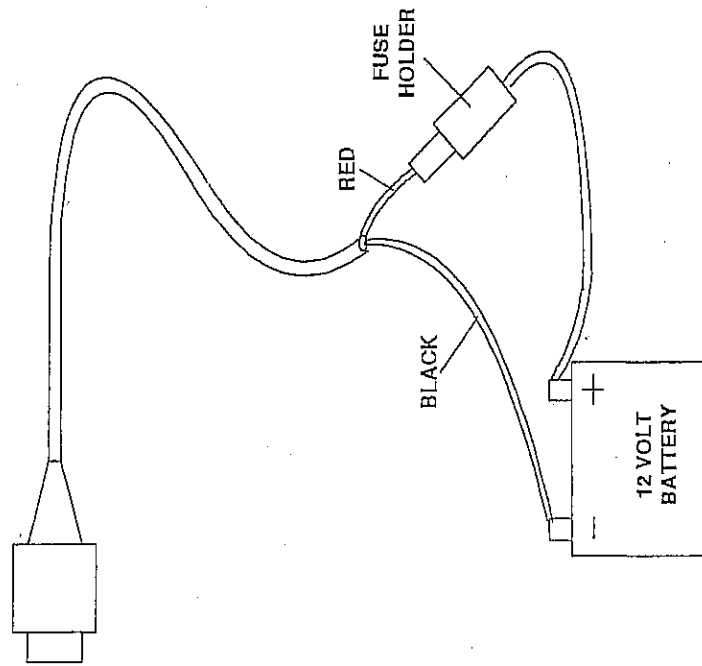

## TROUBLESHOOTING

Unit won't turn on:

1. Check the power cable's connection at the unit. Also check the wiring.
2. Make certain the power cable is wired properly. The red wire connects to the positive battery terminal, black to negative or ground.
3. Check the fuse.
4. Measure the battery voltage at the unit's power connector. It should be at least 11 volts. If it isn't, the wiring to the unit is defective, the battery terminals or wiring on the terminals are corroded, or the battery needs charging.

Unit freezes, locks up, or operates erratically:

1. Electrical noise from the boat's motor, trolling motor, or an accessory may be interfering with the sonar unit. Re-routing the power and transducer cables away from other electrical wiring on the boat may help. Route the sonar unit's power cable directly to the battery instead of through a fuse block or ignition switch often helps, also.
2. Inspect the transducer cable for breaks, cuts, or pinched wires.
3. Check both the transducer and power connectors. Make certain both are plugged in securely to the unit.

Weak bottom echo, digital readings erratic, or no fish signals:

1. Make certain transducer is pointing straight down. Clean the face of the transducer. Oil, dirt, and fuel can cause a film to form on the transducer, reducing its effectiveness. If the transducer is mounted inside the hull, be sure it is shooting through only one layer of fiberglass and that it is securely bonded to the hull. Do NOT use RTV silicone rubber adhesive or MarineTex.
2. Electrical noise from the boat's motor can interfere with the sonar. This causes the sonar to automatically increase its Discrimination or noise rejection feature. This can cause the unit to eliminate weaker signals such as fish or even structure from the display.

### SENS.

This key and the arrow keys adjust the graph's sensitivity. (The digital's sensitivity is adjusted by the unit automatically.) The receiver has 32 steps of adjustment.

### CHART SPEED

Vary the speed of the chart with this key and the arrow keys. There are 5 steps of chart speed adjustment.

### RANGE

The depth range is changed with this key and the arrow keys. The ranges vary from 0-5 feet to 0-180 feet.

### CHART ALARM

Using this key activates the chart alarm. A bar appears on the left side of the display when the chart alarm is adjusted. Any target that appears on the screen between the top and bottom of the chart alarm bar triggers the alarm.

### MODE

The Fish I.D. It has five different "screens" or modes of operation. Use this key to switch between modes.

### FISH I.D.

This key turns the Fish I.D. feature off and on.

### FISH I.D.

#### FISH ALARM

Press both the Fish I.D. and the AUTO key at the same time to activate the Fish Alarm. This is an audible fish alarm.

### AUTO

#### AUTO

Turning the unit on enables the automatic mode. To switch to the manual mode, press the AUTO key. You can return the unit to automatic at any time by pressing the AUTO key again.

## SURVEYING A LAKE

The most successful anglers on any body of water are those who fish it day after day and year after year. Eventually, they learn the hot spots that produce fish consistently. They discover through experience where, and at what depth, they can expect to find the fish they want at any season. And they realize that these productive areas change throughout the year depending on water level, temperature, food, and other factors.

With the Fish I.D. II, anyone can eliminate guesswork and concentrate on the areas where fish are likely to be. Even if it's the first time on the lake!

The most efficient way to become acquainted with a body of water is to survey it with your unit. Start with a map of the lake, if possible, and indicate the promising spots in relation to landmarks on shore.

As you go about your survey, your unit will tell you the depth and type of bottom. It will also reveal suspended fish.

Keep a few marker buoys in the boat, ready to toss overboard. When the unit indicates a school of fish, throw the buoy out. With the school thus marked, you can make your turn and come back to fish in exactly the right spot. This is essential when you're far from shore on a big lake. Unless you mark the school of fish when you're over it, you may not be able to find it again.

## BAIT FISH

The importance of bait fish to successful fishing can't be over-emphasized. They are the principal food of all game fish in most waters.

Bait fish are the plankton feeding forage fish, such as minnows and shad. Bait fish can also be the young of game fish, such as crappies, bluegill, and bass.

Most bait fish concentrate within five feet of the surface where sunlight promotes the growth of the plankton on which they feed. One method of fishing is to use the unit to find the bait fish first. A school of bait fish will look like a "cloud" on the unit's display. Usually, game fish will be nearby, often directly beneath the school of bait fish.

With high sensitivity settings, a second bottom echo (second echo) may appear. This is normal. It's caused by the returning signal reflecting off the surface of the water. Then it makes a second trip to the bottom and back again.

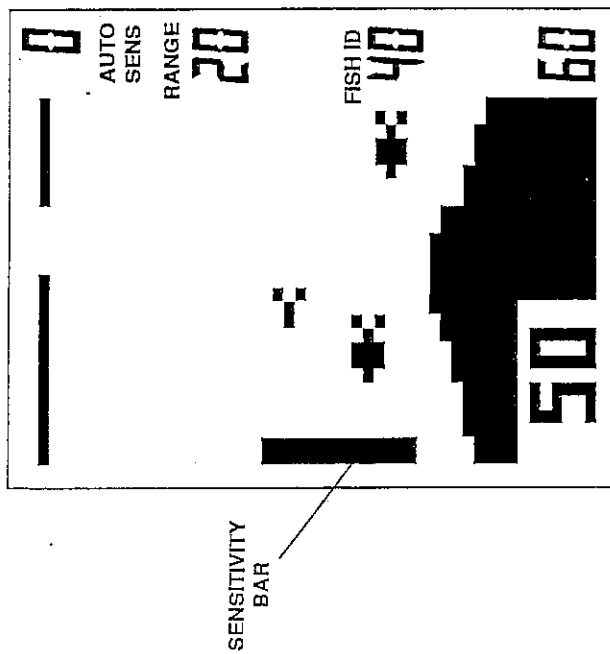

Remember, when the unit's automatic feature is on, the receiver's sensitivity automatically adjusts to the surrounding conditions. The micro-computer places it at a level slightly above the minimum required to pick up the bottom signal. However, it's possible to change the sensitivity level while the unit is in automatic. This may be desirable if the sensitivity level is not high enough to show fish or other small detail. The unit will increase the sensitivity to pick up the bottom signal, then add in the level you programmed.

To adjust the sensitivity while the unit is in automatic, simply press the SENS. key. Then press either the up arrow key to increase it, or the down arrow key to decrease it. As you press the arrow key, the sensitivity bar moves up or down, according to the sensitivity level chosen.

You can adjust the sensitivity in the same manner when the unit is in the manual mode.

## BOAT'S DIRECTION OF TRAVEL

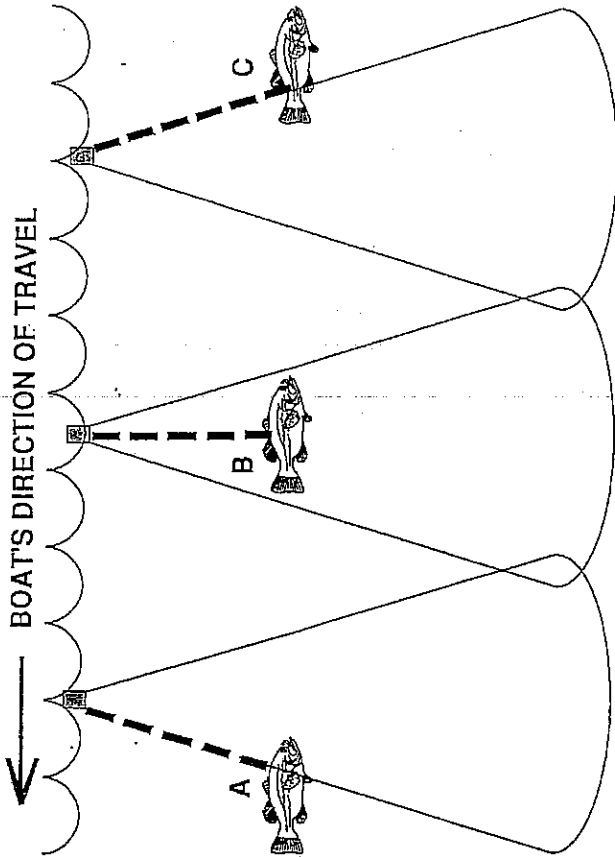

## RANGE

The range automatically changes to keep the bottom signal on the display when the unit is in automatic. The range cannot be changed in when the unit is in the automatic mode. The range can be changed in manual mode. There are six ranges available: 0-5, 15, 30, 60, 120, and 180 feet. To change the range, first make certain the word AUTO is off. Then press the RANGE key. The word RANGE will flash on the right side of the screen. Next, press the up arrow key to switch to a shallower range or press the down arrow key for a deeper range. The range annunciator will stop flashing eight seconds after the last key was pressed.

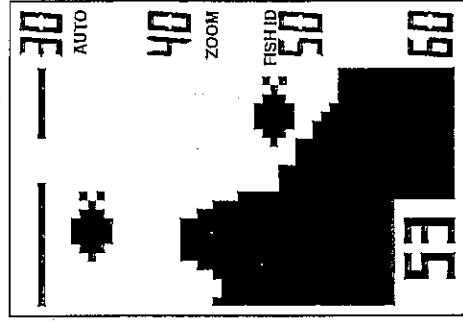
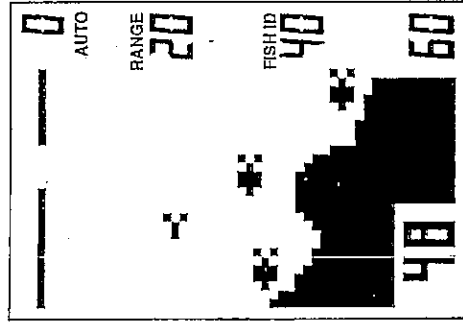

## ZOOM - Automatic operation

Use the Zoom feature to increase the size of the targets on the display. It works by enlarging the bottom half of the selected range. For example, if the range is 0 - 60 feet and the zoom key is pressed, the new range will be 30 - 60 feet. If the unit is in automatic, the bottom will be tracked in this 30 foot window. There are two exceptions to this rule: 1) If you're on the 0-15' range and press the zoom key, the new range will be 10-15'. 2) There is no zoom on the 0-5' range.

To change the zoom range, first press the ZOOM key. The word "ZOOM" flashes on the right side of the screen. Now press the up arrow or the down arrow key to increase or decrease the zoom size. For example, if the range is 0-60 feet, pressing the ZOOM key changes the range to 30-60 feet. While the word "ZOOM" is still flashing, press the up arrow key. This changes the zoom range from 30 feet to 15 feet. Press the up arrow key again, and the zoom range changes to five feet. To turn the zoom feature off, simply press the RANGE key.

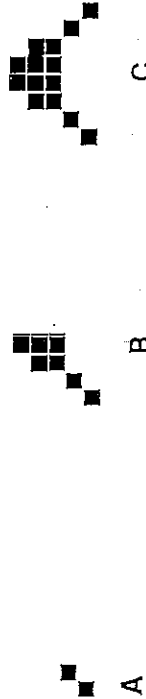

## WATER TEMPERATURE AND THERMOCLINES

Water temperature has an important influence upon the activities of all fish. Fish are cold blooded and their bodies are always the temperature of the surrounding water. During the winter, colder water slows down their metabolism. At this time, they need about a fourth as much food as they consume in the summer.

Most fish don't spawn unless the water temperature is within rather narrow limits. Trout can't survive in streams that get too warm. Bass and other fish eventually die out when stocked in lakes that remain too cold during the summer. While some fish have a wider temperature tolerance than others, each has a certain range within which it tries to stay. Schooling fish suspended over deep water lie at the level that

Both 8 degree and 20 degree transducers give accurate bottom readings, even though the bottom signal is much wider on the 20 degree model. This is because you are seeing more of the bottom. Remember, the shallow edge of the signal shows you the true depth. The rest of the signal tells you whether you are over rocks, mud, etc.

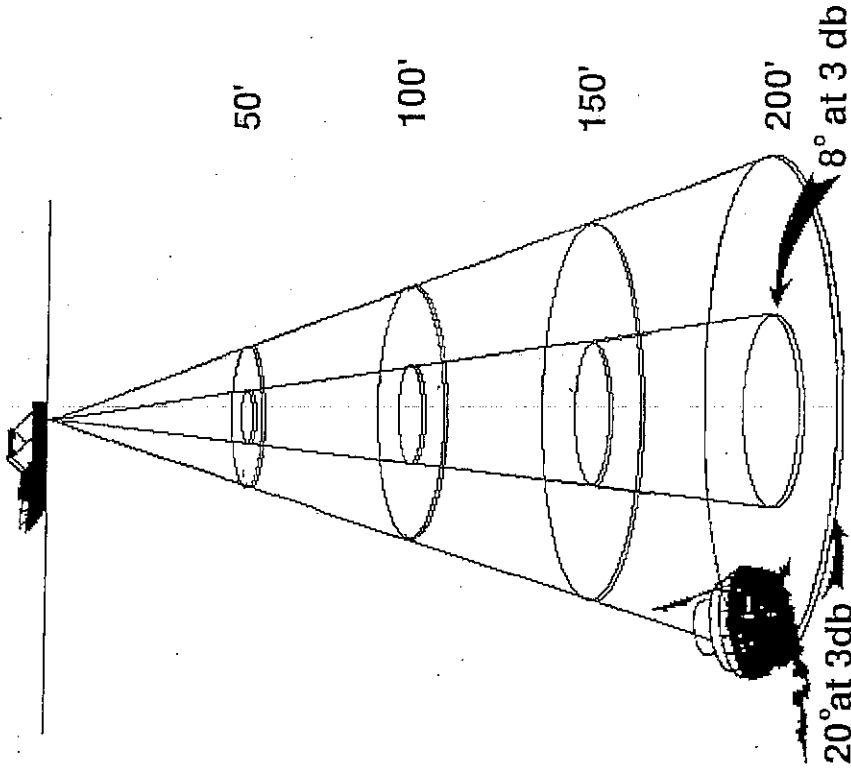

#### SIGNAL INTERPRETATION

Your unit gives an accurate picture of the bottom that your boat is passing. A bottom of firm sand, gravel, shell, or hard clay returns a wide bottom signal. If the automatic feature is off and the bottom signal narrows, then it means that you have moved over a mud bottom. Mud absorbs the sound wave and returns a weak signal. Turn up the sensitivity to see a better bottom signal.

Big rocks or stumps on a smooth bottom send back signals above

#### FISH I.D.

The Fish I.D. feature is automatically on when the unit is first turned on. The computer inside the unit analyzes all echoes, filtering out unwanted signals. It helps eliminate surface clutter, thermoclines, and other undesirable signals. The remaining suspended targets are usually fish. Targets that are identified by the unit as fish are displayed as small, medium, or large fish symbols on the display. These symbols are shown according to the relative size of the fish as seen by the unit. The Fish I.D. feature can only be used in automatic. If you wish to turn it off, or back on again, press the FISH I.D. key. If you press the FISH I.D. key when the unit is in manual, it will put it in automatic and enable the Fish I.D. feature.

To show fish symbols, you must be traveling at a slow trolling speed. There should be some movement of the boat for the Fish I.D. feature to work properly.

If you have difficulty showing fish symbols, try increasing the sensitivity.

**NOTE:** The Fish I.D. feature cannot distinguish between fish and other suspended objects such as turtles, tree branches, trotlines, submerged floats, or other inanimate objects. The micro-computer in this unit is sophisticated, but it can be fooled. The most difficult challenge is individual tree branches extending out from groups of branches. These can be mis-identified as fish by the Fish I.D. feature. Also, large amounts of noise can fool the Fish I.D. feature. This is usually caused by a poor transducer installation. Although the Fish I.D. feature isn't perfect, it can be a valuable aid to the fisherman.

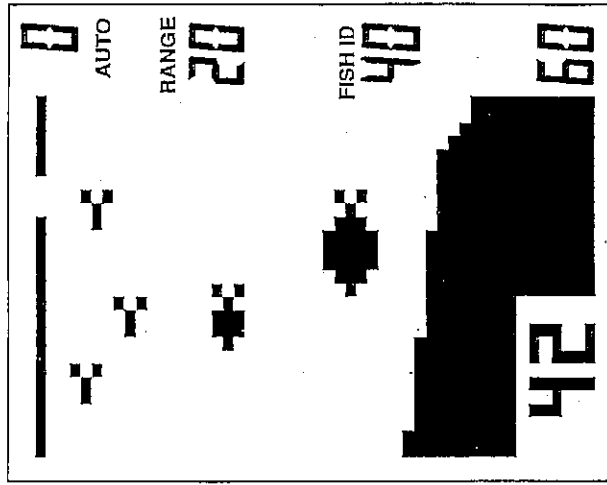

## CHART ALARM

To set the Chart Alarm, press the CHART ALARM key on the keyboard. The words "Chart Alarm" flashes in the lower right corner of the screen. A vertical bar also displays on the left side of the screen. It will stay on the screen for eight seconds or for eight seconds after you have finished adjusting it. This is the Chart Alarm's "window." Any echo that appears between the top and bottom of this bar will sound the alarm. Adjust deep end of this bar to make a smaller or larger alarm "window." The shallow end is automatically adjusted by the unit so it won't be triggered by surface clutter or other false signals. Next, press the down arrow to move the bottom of the bar deeper, or press the up arrow to move it shallower. The alarm bar disappears eight seconds after the last button is pressed.

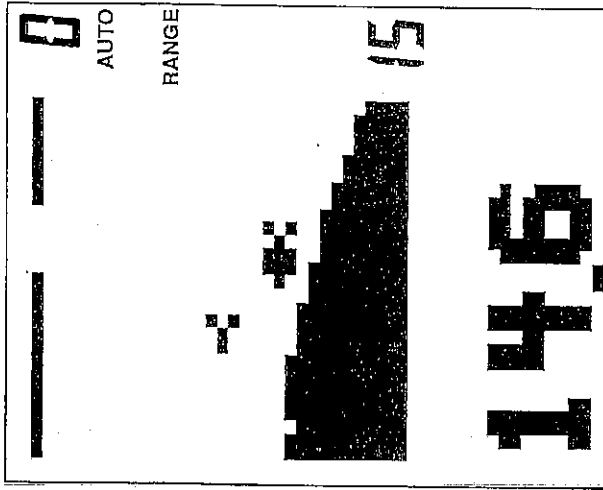

### MODE 3 - Big digital.

a) The digital depth numbers use the lower quarter of the display. The depth is displayed in tenths of a foot to 99.9 feet, then it is displayed in whole numbers.

b) No FASTRAK

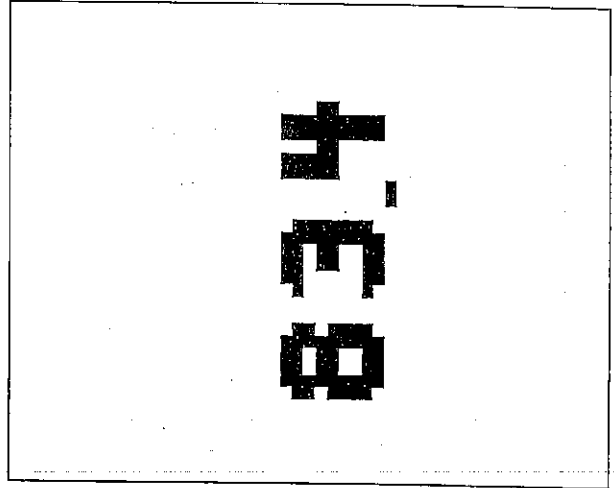

### MODE 4 - Depth only displayed in large digits.

No chart display.

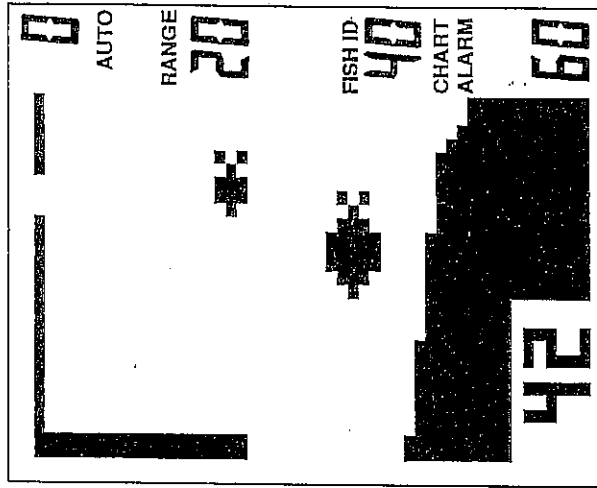

When the "Chart Alarm" signal is on, the alarm is active. If you wish to view the Chart Alarm bar, simply press the CHART ALARM key. The bar will be displayed for eight seconds. Any target that appears on the left side of the screen in the area covered by the chart alarm bar will trigger the alarm.

If the range is changed, the Chart Alarm may need to be changed also since it does not track range settings.



To turn the Chart Alarm off, press the CHART ALARM key, then move the bottom of the bar all the way to its shallowest position using the up arrow key.

### FISH ALARM

Use the FISH ALARM for a distinctive audible alarm when fish or other suspended objects are detected by the FISH I.D. feature. Press the FISH I.D. and the AUTO keys at the same time. The words "FISH ALARM" displays at the bottom right side of the screen. The audible alarm sounds each time the Fish I.D. feature detects a fish or other suspended object. There is a different tone for each fish symbol size.

To turn the Fish Alarm off, press the FISH I.D. and AUTO keys at the same time.

### SPEAKER

The speaker can be turned on and off by pressing the up and down arrow keys at the same time. The speaker is represented by a note symbol above the arrow keys. Whenever it is enabled, a note symbol appears on the right center side of the display. The speaker is enabled when the unit is turned on. NOTE: This applies to the alarms only. The unit will still sound a tone when a key is pressed and the speaker is turned off.

### LIGHT

A light allows operation of the unit at night. Turning the unit on causes the lights to flash for six seconds. Press the RANGE and ZOOM keys at the same time and the lights will stay on. To turn the lights off, press the RANGE and ZOOM keys again. The lights will also go out when the unit is turned off.



### MODE

The Fish I.D. II has five different screen modes. To change modes, press the MODE key. Keep pressing the MODE key until the desired screen appears. A summary of the different screen modes follows.

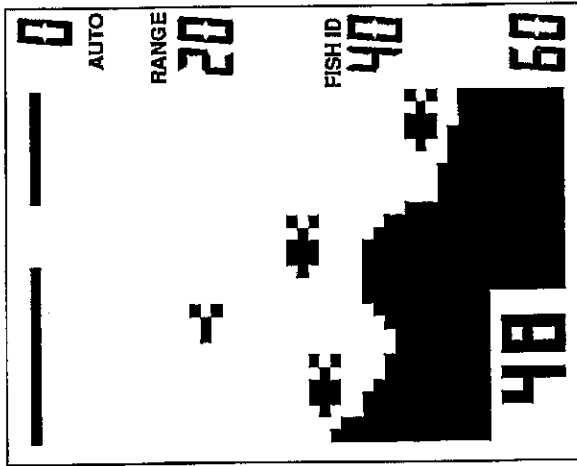

**MODE 1** - This is the default mode used when the unit is first turned on. It has the following features:

a) Small digital depth display in lower left corner. It does not show tenths of a foot. Normal chart display.

b) No FASTRAK.

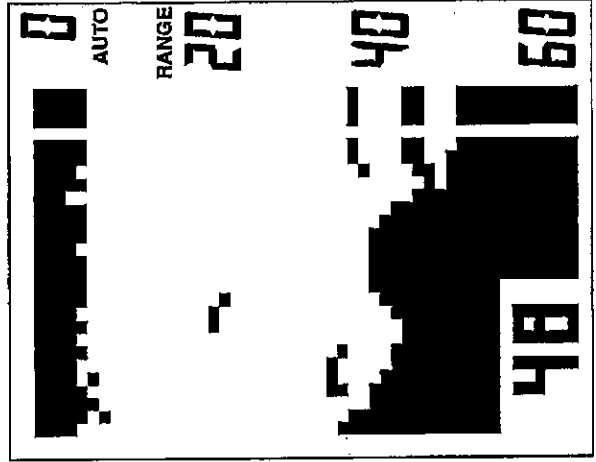

**MODE 2** - This is the same as mode 1 except it has FASTRAK. This displays on the right side of the screen. It converts all echoes to horizontal bars when they first appear on the screen. This gives a rapid update of conditions directly under the boat. Echoes are also scrolled normally across the display. The Fish I.D. feature is not available with this mode.

## AUTO

When the unit is first turned on, the automatic feature is enabled. It works automatically to find and display the bottom depth. The sensitivity and range are also adjusted to keep the bottom signal on the screen at all times. To turn the automatic feature off, simply press the AUTO key once. The word "AUTO" will disappear from the display, signifying the automatic sensitivity and chart range features are off. This also turns the Fish I.D. feature off at the same time. The digital remains on. To return the unit to the automatic mode, press the AUTO key again. This will reset the sensitivity, so you may wish to increase it to see fish or other detail. This will not turn the Fish I.D. feature on. You will have to press the Fish I.D. key to turn it on.

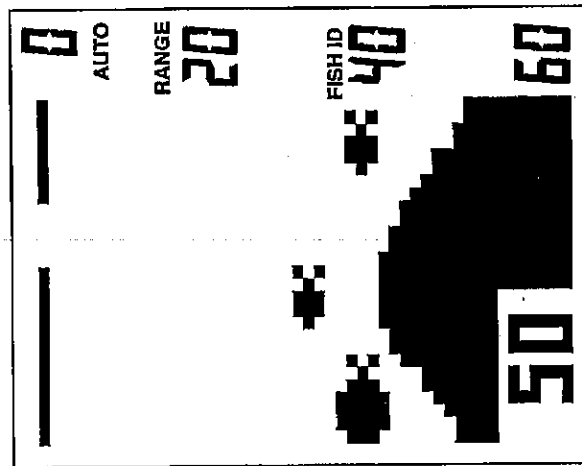

## ALARMS

The unit has two different alarms, a chart alarm and Fish Alarm. The chart alarm consists of a bar that displays on the left side of the screen. The alarm "chirps" whenever the unit detects an echo inside the boundaries of the bar.

Fish Alarm sounds an audible alarm when fish or other suspended objects are detected. It works in conjunction with the Fish I.D. feature. To separate the alarms, the fish alarm's tone sounds different than the chart alarm. Both alarms may be used at the same time.

## MODE 5 - All chart, High Speed Scroll.

The chart scrolls at high speed in this mode. The chart speed can be adjusted with the CHART SPEED key if desired.

- a) Chart uses full screen.
- b) No digital depth indicator.
- c) No FASTRAK.
- d) No automatic operation allowed.
- e) No Fish I.D. feature or Fish Alarm
- f) Chart alarm is allowed.

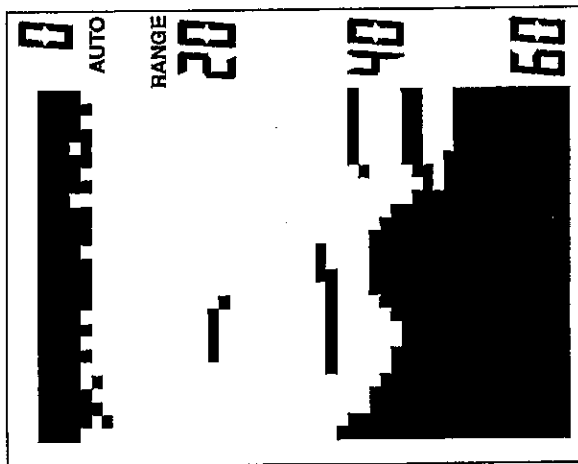

## TRANSDUCERS AND CONE ANGLES

The sound waves from the transducer spread out into the water in a cone shaped beam. This looks much like the beam from a flashlight. The angle between the outside edges of the cone is the cone angle.

Eagle offers a choice of transducers with either an 8 or 20 degree cone angle. Typically, wide cone angle transducers (20 degrees) are ideal for operating in shallow to medium water depths. The 20 degree cone angle allows you to see more of the underwater world. In 15 feet of water the 20 degree cone covers an area about six feet across. The 8 degree transducer covers only about a two foot circle.

The 20 degree transducer is almost always the best to use in fresh water, the 8 degree mostly in salt water. In a deep water environment, (300 feet - fresh water, 100 feet - salt water) the narrow cone angle is more desirable. Since the sound energy is concentrated in a smaller area, it can penetrate to much deeper depths.

### ZOOM - Manual Mode

Zoom operates differently when the unit is in the manual mode. First press the ZOOM key. The bottom half of the range is enlarged, just like the automatic zoom feature. However, if you press an arrow key, the range shifts in one foot increments. The down arrow key to shifts the range down in one foot increments. The up arrow key shifts the range up in one foot increments. For example, if the unit is on the 0-60 foot range, and the manual mode is on, pressing the zoom key, then the down arrow key once will move the 30-60' range to 31'-61'. The best way to use this feature is to change the range to a smaller one, then press the zoom key, shift the range until the area is displayed that you want zoomed. For example, if the bottom depth is 50 feet, and you wish to enlarge the area immediately above it, first change the range to 0-30 feet. Now press the zoom key. Finally, press the down arrow key until the bottom appears. Now you have a fifteen foot zoom window around the bottom signal.

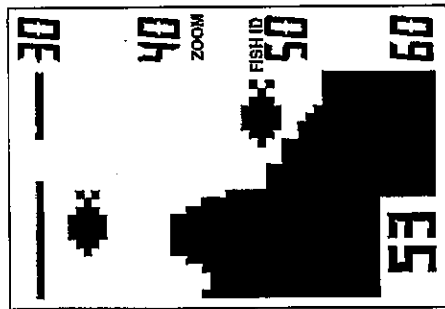
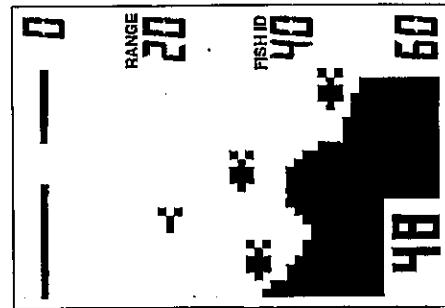

### DIGITAL

Built inside the Fish I.D. II is a complete digital sonar. It automatically discriminates between the valid bottom echoes and false echoes from fish, thermoclines, or other signals. The digital display will show only the bottom depth.

At power on, the digital will flash "0" until it has "locked on" to the bottom signal. Once it has acquired the bottom depth, it will show it in the lower left corner of the display.

the bottom level signal. The height of the signal depends on the target's height. As you pass over a post, it should be clearly visible as a short line extending above the bottom signal.

A steep slope returns a wide signal, the steeper the wider. Signals returned from a high underwater cliff are usually the widest of all.

Brush usually lies on the bottom and shows up as clumps rising above the bottom signal. Brush signals look similar to large rocks; however their signal is not as strong as rock.

### FISH ARCHES

Fish arches are created when the cone of sound passes over a fish. The distance to a fish when the cone first strikes it is shown as "A" on the next page. When the center of the cone strikes the fish, the distance is shorter, as shown in "B". As the cone leaves the fish, the distance increases again as shown in "C".

When the Fish I.D. feature is off, the depth of the water will affect the size and shape of the fish arch due to the cone angle diameter. For example, if the cone passes over a fish in shallow water, the signal displayed on the unit may not arch at all. This is due to the narrow cone diameter and the resolution limitations of the display.

Very small fish probably will not arch at all. Medium sized fish will show a partial arch, or a shape similar to an arch if they're in deep water. Large fish will arch, but turn the sensitivity up in deeper water to see the arch. Because of water conditions, such as heavy surface clutter, thermoclines, etc., the sensitivity sometimes cannot be increased enough to get fish arches.

One of the best ways to get fish arches is to expand or "zoom" a segment of the water. For example, from 45 to 60 feet. The smaller the segment, the better the screen resolution will be. For the best results, turn the sensitivity up as high as possible without getting too much noise on the screen. In medium to deep water, this method should work to display fish arches.

## CHART SPEED

At power on, the chart speed scrolls at a preset speed. To change the speed, press the CHART SPEED key. The word "CHART" will flash on the right side of the display. A vertical bar will also appear on the left side of the screen. This indicates the current chart speed. Next, press the up arrow key if you wish to increase the chart speed. Press the down arrow key to decrease it. When the chart reaches the desired speed, release the key. There are five steps of chart speed. When the chart speed reaches its maximum or minimum level, the unit will sound a tone.

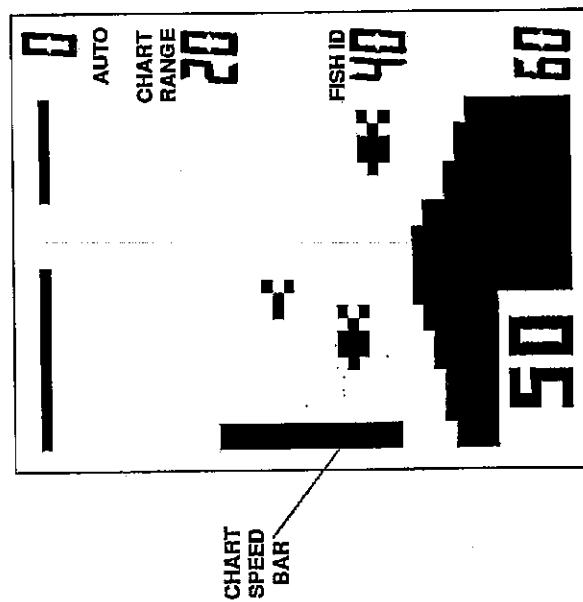

To view the chart speed without changing it, press the CHART SPEED key. The chart speed bar will appear for eight seconds.

At times it is desirable to stop or "freeze" the display to examine an echo before it scrolls off the screen. Pressing the SENS. and CHART SPEED keys at the same time will freeze the display. Press the SENS. and CHART SPEED keys again to start the display moving at the last chart speed setting. If the digital sonar is on, the bottom depth will still be displayed. The digital does not stop when the chart is in the "freeze" mode.

provides this temperature. We assume they are the most comfortable here.

The temperature of water in the lake is seldom constant from top to bottom. Layers of different temperatures form, and the junction of a warm and cool layer of water is called a thermocline. The depth and thickness of the thermocline can vary with the season or time of day. In deep lakes there may be two or more at different depths. Thermoclines are important to fishermen because they are areas where fish are active. Many times bait fish will be above the thermocline while larger game fish will suspend in or just below it.

The Fish I.D. II can detect this invisible layer in the water, but the sensitivity will probably have to be turned up to see it.

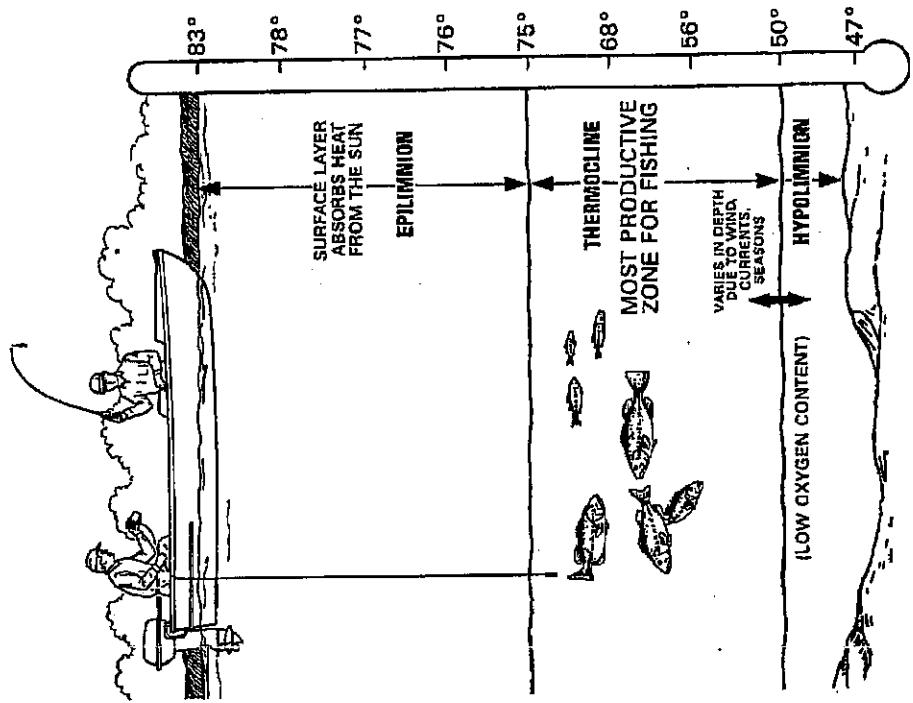

## OPERATION

### SENSITIVITY

The unit is in the AUTO SEARCH mode when it's first turned on. The micro-computer automatically adjusts the sensitivity and range to find and lock onto the bottom. The digital depth flashes "0" until it finds and locks onto the bottom. You can leave the sensitivity in the automatic mode or manually adjust it to suit conditions.

You may need to increase the sensitivity to show fish symbols when the unit is in automatic. To do this, first press the SENS. key. The letters "SENS" will flash on the right side of the display. A vertical bar appears on the left side of the screen. ( See below.) This indicates the sensitivity level. To increase the sensitivity, press and hold the up arrow key until the sensitivity is at the desired level. The down arrow key decreases sensitivity in the same manner. Notice how the sensitivity bar moves as you change settings. It will move up when the sensitivity is increased. You'll also see the change on the display. After you've finished setting the sensitivity level, the letters "SENS" and the sensitivity bar will disappear after eight seconds.

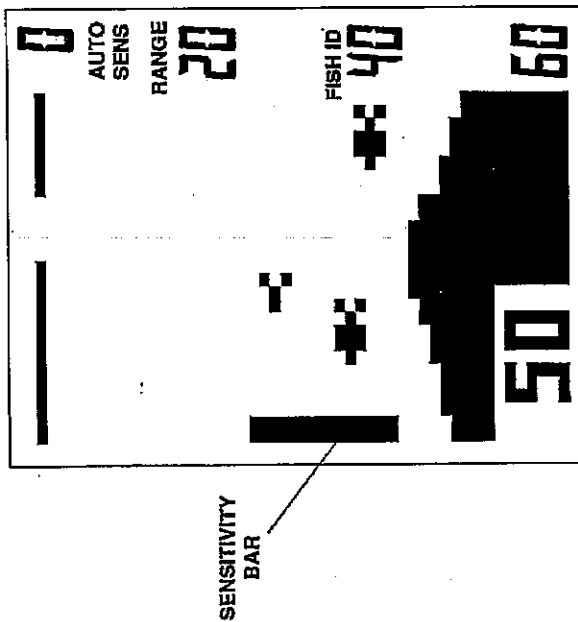

NOTE: All screens shown in this manual are in feet and are simulated.

## SPECIFICATIONS

### Dimensions

5 7/8"H x 7 3/4"W x 3 7/16"D  
1 3/4 pounds

### Transmitter frequency Output Power (typical)

192 kHz  
275 watts peak to peak  
34.4 watts RMS

### Receiver Sensitivity

82 db temperature stabilized

### Operating Current

200 ma (lights off)  
500 ma (lights on)

### Operating Voltage

9-15 vdc

### Number of pixels

50 x 27  
(vertical x horizontal)  
1350 Total

### Display Scroll Speed

.5" per minute (minimum)  
32" per minute (maximum)  
180 feet  
400 feet

### Maximum Chart Range

Maximum Digital Range

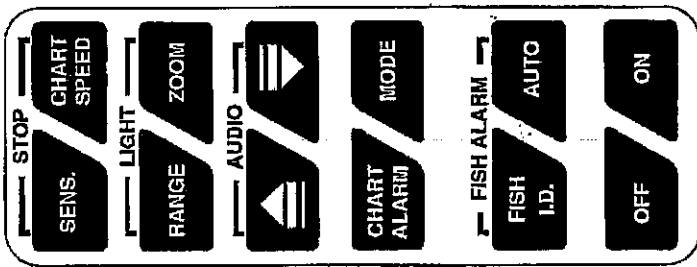

## KEYBOARD BASICS

This section gives a brief explanation of the keyboard. Read the Operation section for a detailed description of each key's operation.



### ON OFF

These keys turn the unit's power on and off. To turn it on, simply press the ON key. To turn it off, press the OFF key.



Pressing any key generates a tone or "beep." This tells you that the unit has accepted a command.

Note: Your unit has metric capability if the letters "FT/M" are printed on the ON key.



### UP and DOWN ARROWS

These keys are used to adjust virtually every feature and function on the unit. Use these keys to adjust the sensitivity, chart speed, range, zoom and chart alarm.

3. The water may be deeper than the sonar's ability to find the bottom. If the sonar can't find the bottom signal while it's in the automatic mode, the digital will flash continuously. It may change the range to limits far greater than the water you are in. If this happens, place the unit in the manual mode, then change the range to a realistic one, (for example, 0-100 feet) and increase the sensitivity. As you move into shallow water, a bottom signal should appear.

4. Check the battery voltage. If the voltage drops, the unit's transmitter power also drops, reducing its ability to find the bottom or targets.

Bottom echo disappears at high speeds or erratic digital reading or weak bottom echo while boat is moving

1. The transducer may be in turbulent water. It has to be mounted in a smooth flow of water in order for the sonar to work at all boat speeds. Air bubbles in the water disrupt the sonar signals, interfering with its ability to find the bottom or other targets. The technical term for this is 'Cavitation'.

2. Electrical noise from the boat's motor can interfere with the sonar. This causes the sonar to automatically increase its Discrimination or noise rejection feature. This can cause the unit to eliminate weaker signals such as fish or even structure from the display. Try using resistor spark plugs or routing the sonar unit's power and transducer cables away from other electrical wiring on the boat.

No fish arches when the Fish ID feature is off:

1. Make certain transducer is pointing straight down. This is the most common problem if a partial arch is displayed. See the Fish Arch section in this manual for more information.

2. The sensitivity may not be high enough. In order for the unit to display a fish arch, it has to be able to receive the fish's echo from the time it enters the cone until it leaves. If the sensitivity is not high enough, the unit displays the fish only when it is in the center of the cone.

3. Use the Zoom feature. It is much easier to display fish arches when zoomed in on a small range of water than a large one. For example, you will have much better luck seeing fish arches with a 30

## INTRODUCTION

Welcome to the world of sportfishing sonar. Your Eagle Fish I.D. II is a high quality sonar designed for both professional and novice users. This unit have an automatic feature that finds and displays the bottom depth, fish, and structure. As you become familiar with your Fish I.D. II, you can "fine tune" the unit to the surrounding conditions to get the most from your sonar.

To get started with your Fish I.D. II, first read the installation section. This is where it all begins, and improper installation can cause problems down the road. After you've read these instructions and installed your unit, read the rest of this manual in detail. The more you know when you get to the water, the more your Fish I.D. II will do for you. Take this manual for reference when you head for the water.

### METRIC FISH ID II USERS NOTICE:

Your unit will display the depth in feet or meters. To use the unit in the feet mode, simply turn the unit on. To use the unit in the metric mode, turn the unit on by pressing the ON key, then press the ON key again. The second press of the ON key switches the unit into the metric mode.

## INSTALLATION

### Mounting

Install the unit in any convenient location, provided there is clearance when tilted for the best viewing angle. Holes in the bracket base allow wood screw or through bolt mounting. Place a piece of plywood on the back of thin panels to secure the mounting hardware. Make certain there is enough room behind the unit to attach the power and transducer cables.

You can route the power and transducer cables through a one inch hole in the mounting surface. First pass the transducer connector and cable up through the hole. Then push the power cable wire down through it. After routing the cables, fill the hole with silicone rubber adhesive (RTV). Offset the bracket to cover the hole. Route the cables through the slot in the rear of the bracket. There are two notches in the bracket that can be punched out for more cables, if necessary.

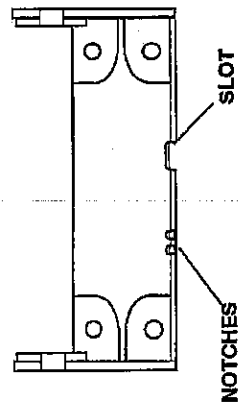

When no noise appears on the sonar unit after all of the above tests, then the noise source is probably cavitation. Many novices or persons with limited experience make hasty sonar installations which function perfectly in shallow water, or when the boat is at rest. In nearly all cases, the cause of the malfunction will be the location and/or angle of the transducer. Start the engine, put it in gear, and slowly advance the throttle. If there is no noise on the display at slow speeds, but increases with the boat speed, then the transducer is improperly installed. The face of the transducer must be placed in a location that has a smooth flow of water at all boat speeds. This is the only way any sonar unit will work when the boat is moving. Read your transducer owner's manual for the best mounting position.

## NOTICE

Your unit has a built-in simulator. All that is required for the simulator to operate is a 12 volt D.C. source. The transducer doesn't have to be connected to the unit.

To start the simulator, first make certain the unit is turned off. Now press any key, (except the OFF key) and press the ON key at the same time. The easiest way to do this is to press and hold a key down, then press the ON key. The unit should start scrolling a chart signal across the screen and the digital depth display should show a bottom depth.

None of the unit's features are accessible when the unit is in the simulator mode.

To turn the simulator off, press the OFF key.





## Free Manuals Download Website

<http://myh66.com>

<http://usermanuals.us>

<http://www.somanuals.com>

<http://www.4manuals.cc>

<http://www.manual-lib.com>

<http://www.404manual.com>

<http://www.luxmanual.com>

<http://aubethermostatmanual.com>

Golf course search by state

<http://golfingnear.com>

Email search by domain

<http://emailbydomain.com>

Auto manuals search

<http://auto.somanuals.com>

TV manuals search

<http://tv.somanuals.com>