

# ***Supra I.D.***

## **INSTALLATION AND OPERATION INSTRUCTIONS**

LITHO IN U.S.A.

988-0106-63

**EAGLE**  <sup>TM</sup>

4. The boat must be moving at a slow trolling speed to see fish arches. If the boat is motionless, fish stay in the cone, showing on the display as straight horizontal lines.

### **ELECTRICAL NOISE**

A major cause of sonar problems is electrical noise. This usually appears on the sonar's display as random patterns of dots or lines. In severe cases, it can completely cover the screen with black dots, or cause the unit operate erratically, or not at all.

To eliminate or minimize the effects of electrical noise, first try to determine the cause. With the boat at rest in the water, the first thing you should do is turn all electrical equipment on the boat off. Make certain the engine is off, also. Turn your Magna on, then turn off ASP (Advanced Signal Processing). There should be a steady bottom signal on the display. Now turn on each piece of electrical equipment on the boat and view the effect on the sonar's display. For example, turn on the bilge pump and view the sonar display for noise. If no noise is present, turn the pump off, then turn on the VHF radio and transmit. Keep doing this until all electrical equipment has been turned on, their effect on the sonar display noted, then turned off.

If you find noise interference from an electrical instrument, trolling motor, pump, or radio, try to isolate the problem. You can usually re-route the sonar unit's power cable and transducer cable away from the wiring that is causing the interference. VHF radio antenna cables radiate noise when transmitting, so be certain to keep the sonar's wires away from it. You may need to route the sonar unit's power cable directly to the battery to isolate it from other wiring on the boat.

If no noise displays on the sonar unit from electrical equipment, then make certain everything except the sonar unit is turned off, then start the engine. Increase the RPM with the gearshift in neutral. If noise appears on the display, the problem could be one of three things; spark plugs, alternator, or tachometer wiring. Try using resistor spark plugs, alternator filters, or routing the sonar unit's power cable away from engine wiring. Again, routing the power cable directly to the battery helps eliminate noise problems. Make certain to use the in-line fuse supplied with the unit when wiring the power cable to the battery.

When no noise appears on the sonar unit after all of the above tests, then the noise source is probably cavitation. Many novices or persons with limited experience make hasty sonar installations which function perfectly in shallow water, or when the boat is at rest. In nearly all cases, the cause of the malfunction will be the location and/or angle of the transducer. The face of the transducer must be placed in a location that has a smooth flow of water at all boat speeds. Read your transducer owner's manual for the best mounting position.

## Weak bottom echo, digital readings erratic, or no fish signals (cont.):

2. Electrical noise from the boat's motor can interfere with the sonar. This causes the sonar to automatically increase its Discrimination or noise rejection feature. This can cause the unit to eliminate weaker signals such as fish or even structure from the display.

3. The water may be deeper than the sonar's ability to find the bottom. If the sonar can't find the bottom signal while it's in the automatic mode, the digital will flash continuously. It may change the range to limits far greater than the water you are in. If this happens, place the unit in the manual mode, then change the range to a realistic one, (for example, 0-100 feet) and increase the sensitivity. As you move into shallower water, a bottom signal should appear.

4. Check the battery voltage. If the voltage drops, the unit's transmitter power also drops, reducing its ability to find the bottom or targets.

## Bottom echo disappears at high speeds or erratic digital reading or weak bottom echo while boat is moving

1. The transducer may be in turbulent water. It must be mounted in a smooth flow of water in order for the sonar to work at all boat speeds. Air bubbles in the water disrupt the sonar signals, interfering with its ability to find the bottom or other targets. The technical term for this is 'Cavitation'.

2. Electrical noise from the boat's motor can interfere with the sonar. This causes the sonar to automatically increase its Discrimination or noise rejection feature. This can cause the unit to eliminate weaker signals such as fish or even structure from the display. Try using resistor spark plugs or routing the sonar unit's power and transducer cables away from other electrical wiring on the boat.

## No fish arches when the Fish ID feature is off:

1. Make certain transducer is pointing straight down. This is the most common problem if a partial arch is displayed. See the Fish Arch section in your owner's manual for more information.

2. The sensitivity may not be high enough. In order for the unit to display a fish arch, it has to be able to receive the fish's echo from the time it enters the cone until it leaves. If the sensitivity is not high enough, the unit displays the fish only when it is in the center of the cone.

3. Use the Zoom feature. It is much easier to display fish arches when zoomed in on a small range of water than a large one. For example, you will have much better luck seeing fish arches with a 30 to 60 foot range than a 0 to 60 foot range. This enlarges the targets, allowing the display to show much more detail.

## TABLE OF CONTENTS

INTRODUCTION .....	1
INSTALLATION .....	1
POWER CONNECTIONS .....	2
KEYBOARD BASICS .....	3
DISPLAY .....	4
MENUS .....	4
OPERATION .....	5
AUTOMATIC .....	5
RANGE .....	5
ZOOM - Automatic Operation .....	6
ZOOM - Manual Operation .....	7
SENSITIVITY .....	8
FISH ID .....	8
CHART SPEED .....	9
DISPLAY MODE .....	10
ALARMS .....	11
FISH ALARM .....	11
DEPTH ALARM .....	11
LAMP .....	13
FEET/METER .....	13
DISPLAY CONTRAST .....	13
ASP (Advanced Signal Processing) .....	14
MENU SUMMARY .....	15
SPECIFICATIONS .....	15
TRANSDUCERS AND CONE ANGLES .....	16
SIGNAL INTERPRETATION .....	17
FISH ARCHES .....	18
WATER TEMPERATURE AND THERMOCLINES .....	19
SURVEYING A LAKE .....	21
BAIT FISH .....	21
SONAR TROUBLESHOOTING .....	22

Copyright © 1990, 1991, 1992 Eagle Electronics  
All rights reserved.

All features and specifications subject to change without notice.  
All screens in this manual are simulated.

## INTRODUCTION

Thank you for purchasing an Eagle sonar. Your Supra I.D. is a high quality sonar designed for both professional and novice fishermen. These units have an automatic feature that finds and displays the bottom, fish, structure, and more! All you have to do is press the on key. However, if you wish to fine tune the unit, all you have to do is press the menu key. The Supra I.D. has powerful features available through easy-to-use menus.

To get started with your Eagle unit, first read the installation section. This is where it all begins. Improper installation can cause problems down the road. After you've read the instructions, install the unit, then read the rest of the manual. The more you know about your unit, the better it will perform for you. Take this manual for reference when you head for the water.

## INSTALLATION

Mount the Supra I.D. in any convenient location, provided there is clearance when it's tilted for the best viewing angle. Holes in the bracket's base allow wood screw or through bolt mounting. It may be necessary to place a piece of plywood on the back side of thin panels to reinforce the panel. Make certain there is enough room behind the unit to attach the power and transducer cables.

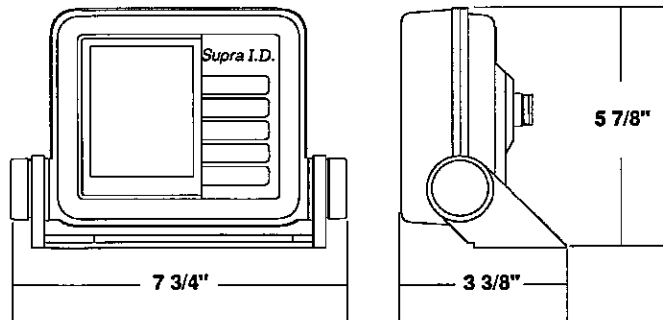

Drill a hole in the dash for the power and transducer cables. The best location for this hole is immediately under the gimbal bracket. This way, the bracket covers the hole. The smallest hole both the power and transducer cables can pass through is one inch. Pass the transducer cable through the hole from under the dash. Then drop the power cable down from the front side of the dash. Slide the bracket over the hole, then

# IMPORTANT SERVICE INFORMATION!

If your unit is not working, or if you need technical help, please use the following troubleshooting section before contacting a service center or the factory customer service department. It may save you the trouble of returning your unit.

## SONAR TROUBLESHOOTING

### Unit won't turn on:

1. Check the power cable's connection at the unit. Also check the wiring.
2. Make certain the power cable is wired properly. The red wire connects to the positive battery terminal, black to negative or ground.
3. Check the fuse.
4. Measure the battery voltage at the unit's power connector. It should be at least 11 volts. If it isn't, the wiring to the unit is defective, the battery terminals or wiring on the terminals are corroded, or the battery needs charging.

### Unit freezes, locks up, or operates erratically:

1. Electrical noise from the boat's motor, trolling motor, or an accessory may be interfering with the sonar unit. Re-routing the power and transducer cables away from other electrical wiring on the boat may help. Route the sonar unit's power cable directly to the battery instead of through a fuse block or ignition switch.
2. Inspect the transducer cable for breaks, cuts, or pinched wires.
3. Check both the transducer and power connectors. Make certain both are securely plugged in to the unit.

### Weak bottom echo, digital readings erratic, or no fish signals:

1. Make certain transducer is pointing straight down. Clean the face of the transducer. Oil, dirt, and fuel can cause a film to form on the transducer, reducing its effectiveness. If the transducer is mounted inside the hull, be sure it is shooting through only one layer of fiberglass and that it is securely bonded to the hull. Do NOT use RTV silicone rubber adhesive or Marinotex™.

## SURVEYING A LAKE

The most successful anglers on any body of water are those who fish it day after day and year after year. Eventually, they learn the hot spots that produce fish consistently. They discover through experience where, and at what depth, they can expect to find the fish they want at any season. And they realize that these productive areas change throughout the year depending on water level, temperature, food, and other factors.

With the Supra I.D., anyone can eliminate guesswork and concentrate on the areas where fish are likely to be. Even if it's the first time on the lake!

The most efficient way to become acquainted with a body of water is to survey it with your Supra I.D. Start with a map of the lake, if possible, and indicate the promising spots in relation to landmarks on shore.

As you go about your survey, your Supra I.D. will tell you the depth and type of bottom. It will also reveal suspended fish.

Keep a few marker buoys in the boat, ready to toss overboard. When the Supra I.D. indicates a school of fish, throw the buoy out. With the school thus marked, you can make your turn and come back to fish in exactly the right spot. This is essential when you're far from shore on a big lake. Unless you mark the school of fish when you're over it, you may not be able to find it again.

## BAIT FISH

The importance of bait fish to successful fishing can't be over-emphasized. They are the principle food of all game fish in most waters.

Bait fish are the plankton feeding forage fish, such as minnows and shad. Bait fish can also be the young of game fish, such as crappies, bluegill, and bass.

Most bait fish concentrate within five feet of the surface where sunlight promotes the growth of the plankton on which they feed. One method of fishing is to use the Supra I.D. to find the bait fish first. With the Fish ID feature off, a school of bait fish will look like a "cloud" on the display. Usually, game fish will be nearby, often directly beneath the school of bait fish.

route the transducer and power cables out the slots in the bracket. Finally, fasten the bracket to the dash.

## POWER CONNECTIONS

The Supra I.D. works from a 12 volt DC system only. For the best results, run the power cable directly to the boat's battery. Keep the power cable away from other boat wiring, especially the engine's wires. This will give the best isolation from electrical noise. If the supplied cable is not long enough to reach the battery, splice #18 gauge insulated wire to it. You can attach the power cable to an accessory or power buss, however, you may have problems with electrical interference. See page 24 for more information on electrical noise.

These units have reverse polarity protection. No damage will occur if the power wires are reversed. However, the unit will not work until the wires are attached correctly.

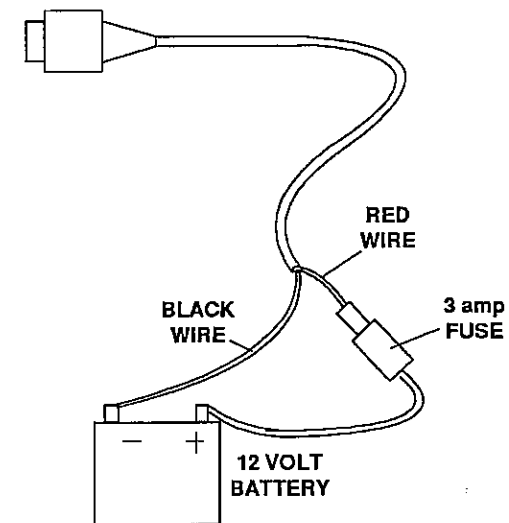

## KEYBOARD BASICS

The unit sounds a tone when you press any key. This tells you the unit has accepted a command.

### ON/CLEAR

Use this key to turn the unit on. It also clears menu selections and the menus from the screen.

### OFF

This key turns the unit off.

### MENU

The Supra I.D. has many menus of features that are accessed with this key.

### UP and DOWN ARROWS

Use these keys to adjust virtually every feature and function on the unit. They are used to adjust the sensitivity, chart speed, range, and more.

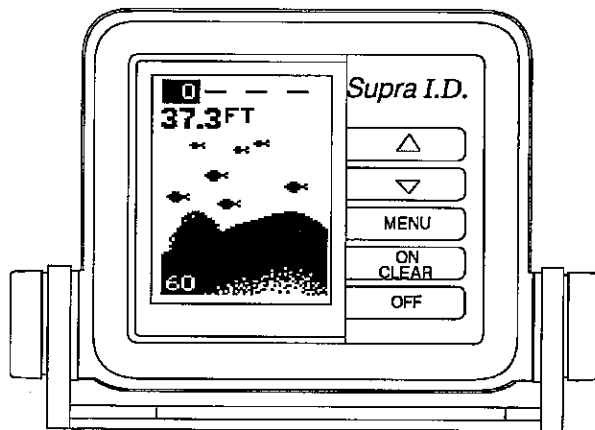

**NOTE:** The up arrow key also stops and starts the chart when no menus are displayed. In other words, anytime you wish to stop the chart, first make certain no menu is on the screen. Then press the up arrow key. The chart will freeze and the word "STOP" appears at the top right portion of the screen. To start the chart, press the up arrow key again.

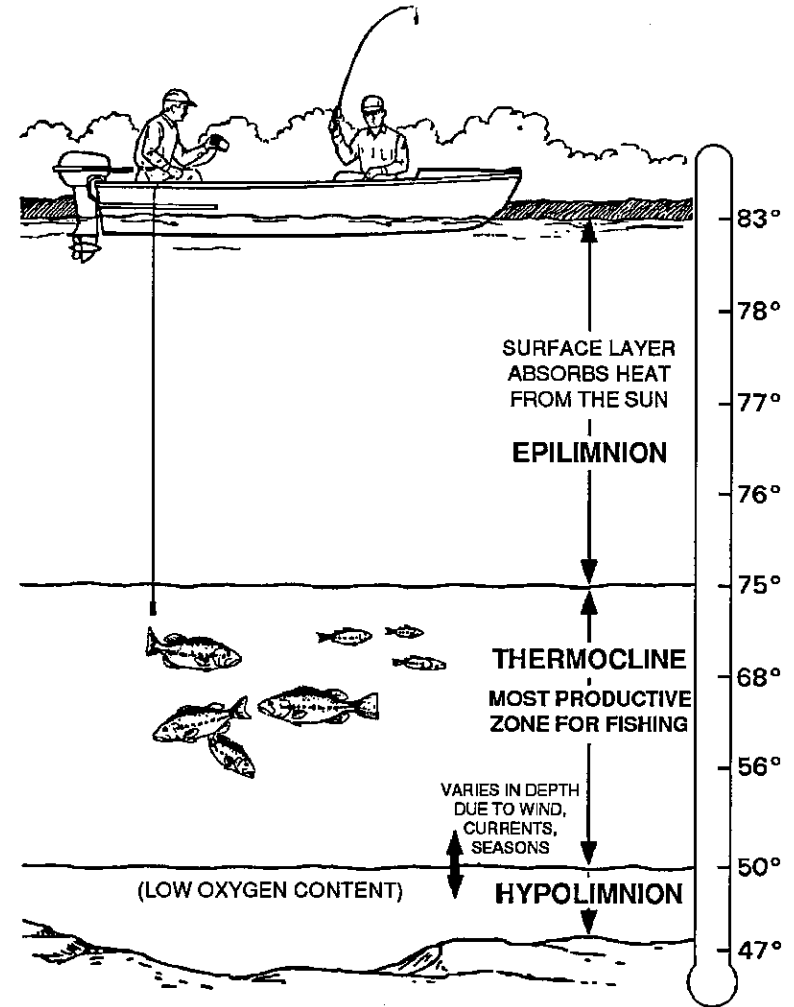

The temperature of water in the lake is seldom constant from top to bottom. Layers of different temperatures form, and the junction of a warm and cool layer of water is called a thermocline. The depth and thickness of the thermocline can vary with the season or time of day. In deep lakes there may be two or more at different depths. Thermoclines are important to fishermen because they are areas where fish are active. Many times bait fish will be above the thermocline while larger game fish will suspend in or just below it.

The Supra I.D. can detect this invisible layer in the water, but the sensitivity will probably have to be turned up to see it.

Very small fish probably will not arch at all. Medium sized fish will show a partial arch, or a shape similar to an arch if they're in deep water. Large fish will arch, but turn the sensitivity up in deeper water to see the arch. Because of water conditions, such as heavy surface clutter, thermoclines, etc., the sensitivity sometimes cannot be increased enough to get fish arches.

One of the best ways to get fish arches is to expand or "zoom" a segment of the water. For example, from 45 to 60 feet. The smaller the segment, the better the screen resolution will be. The easiest way to do this on the Supra I.D. is with the Zoom feature. This feature expands the echoes, making it easier to see detail. For the best results, turn the sensitivity up as high as possible without getting too much noise on the screen. In medium to deep water, this method should work to display fish arches.

If you see fish signals when the unit is in the manual mode, but don't get fish symbols when the Fish I.D. feature is on, try increasing the sensitivity.

## WATER TEMPERATURE AND THERMOCLINES

Water temperature has an important-if not controlling-influence upon the activities of all fish. Fish are cold blooded and their bodies are always the temperature of the surrounding water. During the winter, colder water slows down their metabolism. At this time, they need about a fourth as much food as they consume in the summer.

Most fish don't spawn unless the water temperature is within rather narrow limits. A surface temperature meter helps identify the desired surface water spawning temperatures for various species. Trout can't survive in streams that get too warm. Bass and other fish eventually die out when stocked in lakes that remain too cold during the summer. While some fish have a wider temperature tolerance than others, each has a certain range within which it tries to stay. Schooling fish suspended over deep water lie at the level that provides this temperature. We assume they are the most comfortable here.

## DISPLAY - General

The lights flash for about ten seconds when the Supra I.D. is turned on. Three menus appear, one after the other. The menus are the lights (LAMP), feet-meter selection (FEET/METER), and contrast adjustment (DARK/LIGHT). To turn the lights on, press the up arrow key. To switch from feet to meters, press the down arrow key when the proper menu appears. To adjust the contrast, wait for the DARK/LIGHT menu to appear. Now press the up arrow key to darken the screen, the down arrow to lighten it. The menus disappear after a few seconds. If you don't want to wait, press the ON/CLEAR key to clear the menus from the screen.

When the Supra I.D. is first turned on, the display appears similar to the one below. The unit is in the automatic mode and the Fish ID feature is on. The depth range displays on the left side of the screen. In this example, the range is from 0 to 60 feet. The digital bottom depth display shows at the top left portion of the screen.



## MENUS

The Supra I.D. use menus to guide you through the unit's functions and features. The menu key accesses these features, allowing you to customize the unit to your particular needs and water conditions. All you have to do to leave one menu and enter another is press the menu key repeatedly. If you ever get lost in the menus, simply press the ON/CLEAR key. This clears the menus from the screen.

Menus change depending on the mode the unit is in. For example, if the automatic mode is turned off, the sensitivity menu changes from "AUTO SENS" to "MAN SENS." Other messages may appear in menu boxes or new menus can appear, again depending on previous selections.

## OPERATION

### AUTOMATIC

When the Supra I.D. is first turned on, the automatic feature is enabled. This feature automatically adjusts the unit's range and sensitivity according to water conditions. It always keeps the bottom depth displayed in the lower portion of the screen.



To turn the automatic feature off, press the menu key until the AUTO/MAN menu appears. Now press the down arrow key. This highlights the letters "MAN." The unit is now in the manual mode. Wait a few seconds and the menu will scroll off the screen's left side. Pressing the ON/CLEAR key also clears it. To turn the automatic feature on again, repeat the above steps, except this time press the up arrow key.

### RANGE

You can't adjust the range when the Supra I.D. is in the automatic mode. It is adjustable when the unit is in the manual mode, however. To do so, first put the unit in the manual mode. Now press the ON/CLEAR key to clear the screen. Then press the menu key until the "RANGE SEL" menu appears as shown. The current range shows at the bottom of the menu. In this case, the range is 60 feet. Now press the up arrow key to decrease the range, the down arrow key increases the range. After you select the desired range, press the ON/CLEAR key to clear the display. If you wait a few seconds, it will automatically clear.



## FISH ARCHES

Fish arches are created when the cone of sound passes over a fish. The distance to a fish when the cone first strikes it is shown as "A" below. When the center of the cone strikes the fish, the distance is shorter as shown "B". As the cone leaves the fish, the distance increases again as shown in "C".

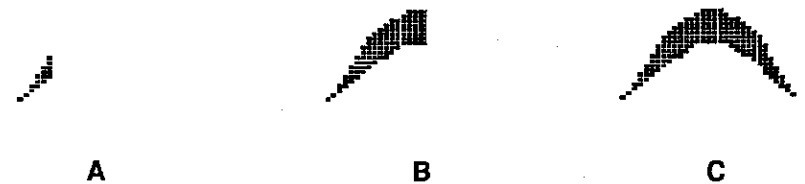
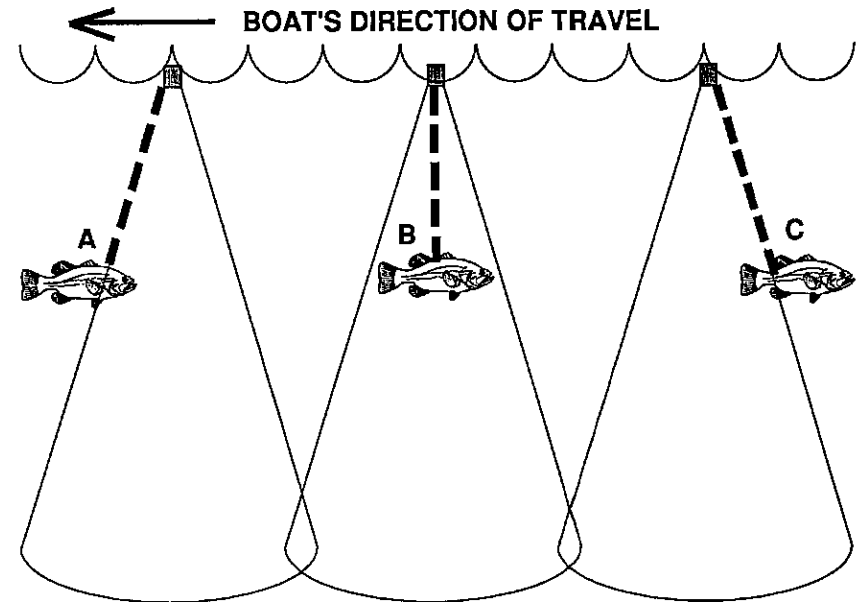

When the Fish I.D. mode is off, the depth of the water will affect the size and shape of the fish arch due to the cone angle diameter. For example, if the cone passes over a fish in shallow water, the signal displayed on the Supra I.D. may not arch at all. This is due to the narrow cone diameter and the resolution limitations of the display.



Both 8 degree and 20 degree transducers give accurate bottom readings, even though the bottom signal is much wider on the 20 degree model. This is because you are seeing more of the bottom. Remember, the shallow edge of the signal shows you the true depth. The rest of the signal tells you whether you are over rocks, mud, etc.

## SIGNAL INTERPRETATION

Your Supra I.D. gives an accurate picture of the bottom that your boat is passing. A bottom of firm sand, gravel, shell, or hard clay returns a fairly wide signal. If the automatic mode is off and the signal narrows down, then it means that you have moved over a mud bottom. Mud absorbs the sound wave and returns a weak signal. Turn up the sensitivity to see a better bottom signal.

Big rocks or stumps on a smooth bottom send back signals above the bottom level signal. The height of the signal depends on the target's height. As you pass over a post, it should be clearly visible as a short line extending above the bottom signal.

A steep slope returns a wide signal, the steeper the wider. Signals returned from a high underwater cliff are usually the widest of all.

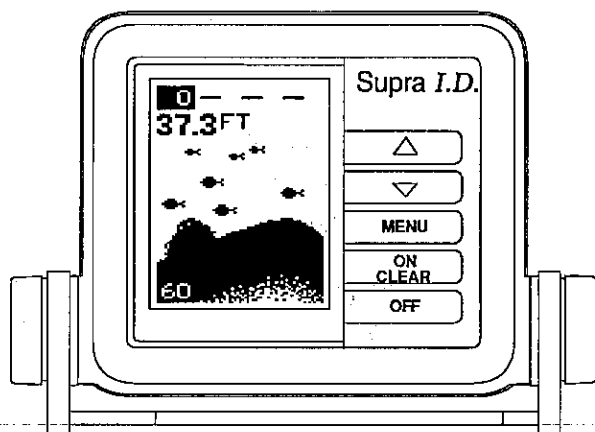

The Supra I.D. has the following ranges:

10, 20, 40, 60, 120, 240, 480, and 900 feet.  
and  
5, 10, 20, 40, 60, 100, 200, and 300 meters.

## ZOOM

The zoom feature enlarges all echoes on the screen. If the unit is in the automatic mode, it tracks the bottom signal, always keeping it near the bottom of the screen. This lets you see small detail, at the same time enlarging all echoes that appear on the screen. The unit doesn't track the bottom in the manual mode, and the adjustments are slightly different.

### Zoom - Automatic Operation

To zoom the display, first press the MENU key until the RANGE/ZOOM menu appears. Now press the down arrow key. This switches the unit into the zoom mode. A new menu immediately appears as shown on the right. This is the zoom size menu. Zoom size is the distance between the upper limit and the lower limit. The upper limit shows at the top left corner of the



screen. The lower limit is in the bottom left corner. For example, if the upper limit is 40 feet and the lower limit is 70 feet, the zoom window size is 30 feet. The word "TRACK" appears in this menu when you first activate the zoom. This means the Supra I.D. is tracking the bottom in a zoom window, always keeping it on the display.

Press the up arrow key to decrease the zoom size, press the down arrow key to increase the zoom size.

The Supra I.D. has the following zoom ranges:

10, 20, 30, 60, 120, 240, and 480 feet  
and  
5, 10, 20, 30, 50, 100, and 150 meters.

When the unit is switched into the zoom mode, the letters "ZM" appear at the top of the screen. The zoom window size displays in the top right corner of the screen.



To turn the zoom feature off, press the menu key until the RANGE/ZOOM menu appears. Now press the up arrow key. This switches the unit into the range mode, which turns the zoom feature off.

### Zoom - Manual Operation

To operate the zoom feature when the Supra I.D. is in the manual mode, first press the menu key. Then press the down arrow key in the RANGE/ZOOM menu to place the Magna in the zoom mode. The zoom size menu automatically appears next. You can change the zoom size by pressing the up or down arrows. After you select the desired zoom size, press the menu key until the "MOVE ZOOM" menu appears. This menu lets you move the zoom window up or down in *one foot* increments by pressing the arrow keys. Thus, you can move the zoom window up towards the surface, down to the bottom, or anywhere in between. The window stays where you put it. It doesn't track the bottom signal.

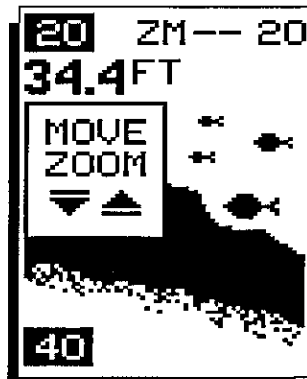

To turn the zoom feature off, press the menu key until the RANGE/ZOOM menu appears. Now press the up arrow key. This switches the unit into the range mode, which turns the zoom feature off.

### TRANSDUCER CONE ANGLES

The sound waves from the transducer spread out into the water in a cone shaped beam. This looks much like the beam from a flashlight. The angle between the outside edges of the cone is the cone angle.





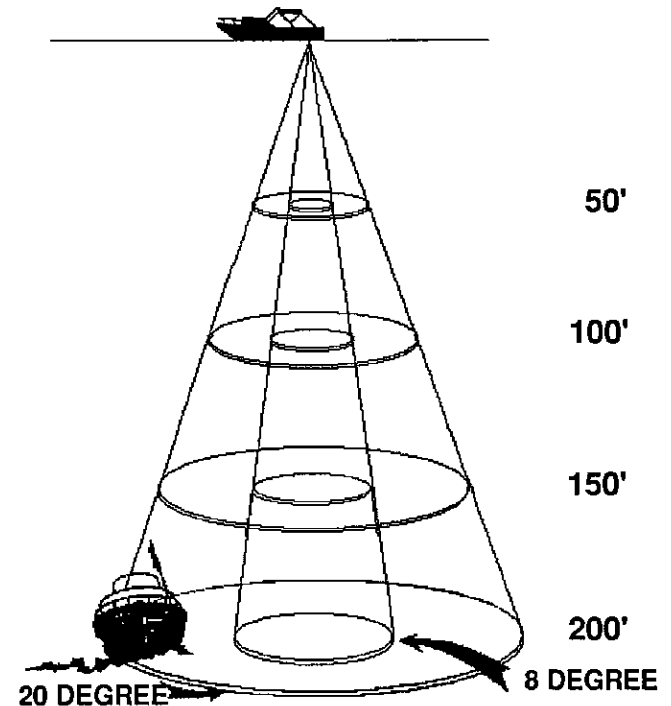







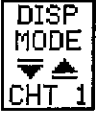

Eagle offers a choice of transducers with either an 8 or 20 degree cone angle. The transducer supplied with the Supra I.D. has a 20 degree cone angle. Typically, wide cone angle transducers (20 degrees) are ideal for operating in shallow to medium water depths. The 20 degree cone angle allows you to see more of the underwater world. In 15 feet of water the 20 degree cone covers an area about six feet across. The 8 degree transducer covers only about a two foot circle.

The 20 degree transducer is almost always the best to use in fresh water, the 8 degree mostly in salt water. In a deep water environment, (300 feet - fresh water, 100 feet - salt water) the narrow cone angle is more desirable. Since the sound energy is concentrated in a smaller area, it can penetrate to much deeper depths.



## MENU SUMMARY

The menus listed below are shown in order as you press the MENU key while the Supra I.D. is in the normal mode with automatic and Fish ID on. The order of the menus (and the menus themselves) will change as different features are selected, however this is order the menus are in when the unit is first turned on.

- |   |   |   |   |
|---|---|---|---|
| 1.   | 2.   | 3.   | 4.   |
| 5.   | 6.   | 7.   | 8.   |
| 9.   | 10.  | 11.  | 12.  |
| 13.  | 14.  |   |   |

## SPECIFICATIONS

Dimensions	7 3/4" W x 5 7/8" H x 3 3/8"D
Input Voltage	10 - 15 vDC
Current Drain	600 ma (lights off) 750 mz (lights on)
Transmitter	
Frequency	192 kHz
Output Power	275 watts (peak-to-peak) 34.4 watts (RMS)
Display	100 pixels (H) x 65 pixels (W) 6500 pixels total Supertwist Liquid Crystal Display

## SENSITIVITY

The sensitivity menu lets you control the unit's ability to pick up echoes. A low sensitivity level excludes much of the bottom information, fish signals, and other detail. High sensitivity settings lets you see features, but it can also clutter the screen with noise and other unwanted signals. Typically, the best sensitivity level shows a good, solid bottom signal with grayline.

The Supra I.D. adjusts the sensitivity level to keep a solid bottom signal on the screen. It adds a little extra when it's in the automatic mode. This gives it the capability to show fish and other detail. However, situations occur where it becomes necessary to increase or decrease the sensitivity level. Typically, this occurs when you wish to see more detail, so you need to increase the sensitivity. The procedure to adjust it is the same whether the unit is in the automatic or manual mode.

To change the sensitivity level, first press the menu key until the sensitivity menu appears. If the unit is in automatic, the menu shows "AUTO SENS." Otherwise, the menu shows "MAN SENS." Now press the up arrow key to increase the sensitivity, the down arrow to decrease it. A vertical bar graph in the menu box shows the sensitivity level. Echoes scrolling onto the screen will also show the effects of the sensitivity change. If you reach the maximum or minimum sensitivity level, a tone sounds alerting you to the limits.

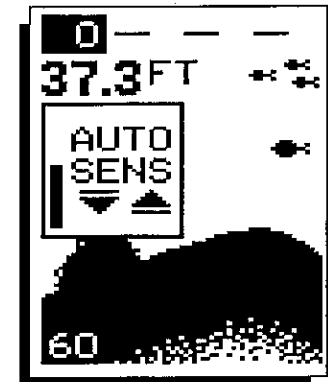

After you've adjusted the unit to the desired sensitivity level, press the ON/CLEAR key to clear the display. If you wait a few seconds, it will automatically clear.

## FISH ID FEATURE

The Fish ID feature identifies targets that meet certain conditions as fish. The micro-computer analyses all echoes and eliminates surface clutter, thermoclines, and other undesirable signals. In most instances, remaining targets are fish. The Fish ID feature displays symbols on the screen in place of the actual fish echoes. There are four symbol sizes: tiny, small,

medium, and large. These show the relative size between targets. In other words, it displays a small fish symbol when it thinks a target is a small fish, a medium fish symbol on a larger target, etc.

The micro-computer is sophisticated, but it can be fooled. It can't distinguish between fish and other suspended objects such as turtles, submerged floats, air bubbles, etc. Individual tree limbs extending outwards from a group of limbs are the hardest objects for the Fish ID feature to distinguish from fish. You may see Fish ID symbols on the screen when, in fact, there are no fish. Practice with the unit when the Fish ID feature is on and off to become more familiar with Fish ID.

When the Supra I.D. is first turned on, the Fish ID feature is automatically turned on, also. To turn this feature off, press the menu key until the Fish ID feature's menu appears as shown below. Now press the down arrow key. This turns the feature off. To turn it back on, repeat the above steps, but press the up arrow key instead.



The Fish ID feature can't be used when the Supra I.D. is in the manual mode. If you turn the automatic feature off, the Fish ID feature will automatically be turned off, also.

## CHART SPEED

The rate echoes scroll across the screen is called the chart speed. It's adjustable by pressing the menu key until the chart speed menu appears as shown at the top of the next page. Chart speed is set to maximum when the Supra I.D. is first turned on. To decrease it, press the down arrow key. Press the up arrow key to increase the speed again. The bar graph in the Chart Speed menu box shows a graph of the speed. Echoes scrolling onto the screen will also show the effects of the change. If you reach the maximum or minimum level, an warning tone sounds.

To stop the chart, first clear any menu from the screen by pressing the ON/CLEAR key. You can't stop the chart while a menu is displayed. Now press the up arrow key. The chart will freeze and the word "STOP" appears at the top right portion of the screen as shown at the top of the next page. To start the chart, press the up arrow key again.

the change. If you reach the maximum or minimum level, a tone sounds alerting you to the limits. The menu will clear automatically after a few seconds or you can press the ON/CLEAR key to clear the screen.



## ASP (Advanced Signal Processing)

ASP is a program embedded in the Supra I.D.'s computer that is specifically designed to eliminate noise. It continually monitors the signals from the receiver, determines which echoes are noise and rejects them. This allows true target echoes to display on the screen with a minimum of clutter. This feature is especially useful since it typically lets you operate the boat at all speeds without adjusting the sensitivity or other controls. When the Supra I.D. is first turned on, ASP is enabled. To turn ASP off, press the menu key repeatedly until the ASP menu appears. Now press the up arrow to turn it on or the down arrow to turn it off. The menu will clear automatically after a few seconds or you can press the ON/CLEAR key to clear the screen.

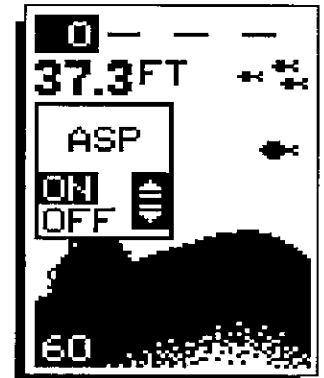

## LAMP

The Supra I.D. and Supra I.D. Plus' display is backlighted for night use. To turn the backlights on or off, press the menu key repeatedly until the LAMP menu appears. Now press the up arrow to turn the lights on or the down arrow to turn them off. The menu will clear automatically after a few seconds or you can press the ON/CLEAR key to clear the screen.

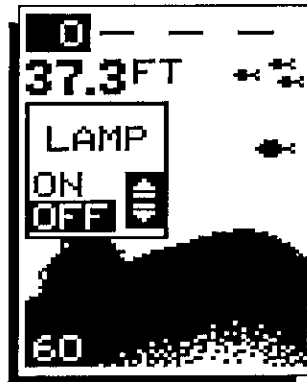

## FEET/METER

The Supra I.D. can show the depth in feet or meters. When the unit is in the metric mode, all depth readings, ranges, zooms, and alarm settings are in meters. When a unit is in the feet mode, all of the above settings are in feet.

To change from feet to meters or vice-versa, press the menu key until the FEET/METER menu appears. Press the down arrow key to switch to metric, the up arrow to switch to feet. Displays show in feet when the unit is first turned on. The menu will clear automatically after a few seconds or you can press the ON/CLEAR key to clear the screen.



## DISPLAY CONTRAST

The unit's display contrast is adjustable to suit different lighting conditions. This will help you see the screen from different angles, or at various times of the day.

To adjust the contrast, press the menu key until the DARK/LIGHT menu appears. To decrease it, press the down arrow key. Press the up arrow key to increase the contrast. The bar graph in the Dark/Light menu box shows a graph of the contrast. The screen will also show the effects of

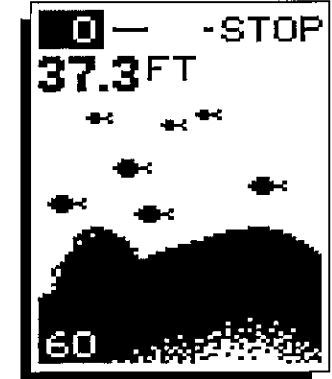
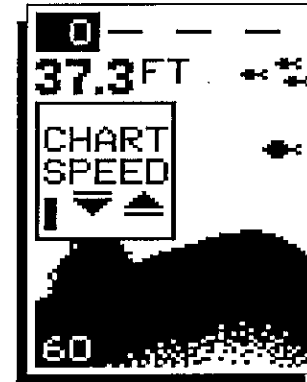

## DISPLAY MODE

The Supra I.D. has three different screen modes. To change modes, press the MENU key until the "DISP MODE" (Display Mode) menu appears. Then press the up or down arrow keys until the desired mode number appears. The modes are as follows:

### CHT 1 (Chart #1)

This is the default mode used when the Supra I.D. is first turned on. It has the following features:

1. Automatic On
2. Fish ID Feature On
3. Digital Depth Display On

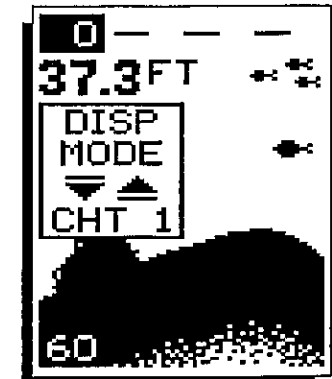

### CHT 2 (Chart #2)

This is the High Speed Scroll mode. It shifts the chart speed into high gear, scrolling echoes at a high rate. It has the following features:

1. Automatic Off
2. Fish ID Feature Off
3. Digital Depth Display Off



## DIG 1 (Digital #1)

This is the digital only screen. It shows the digital depth display at the top of the screen in very large numbers. The shallow and deep alarm settings are displayed beneath the digital depth. No chart shows on this screen.

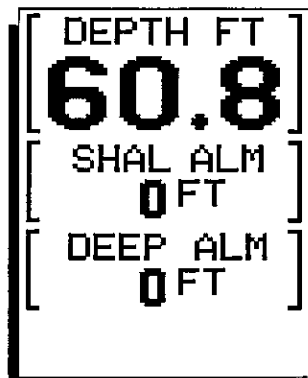

## ALARMS

### FISH ALARM

The Fish Alarm sounds a tone when a fish symbol appears on the screen. To use the fish alarm, press the menu key until the "FISH ALARM" menu appears on the screen. Now press the up arrow key to turn the alarm on. Repeat the above steps to turn the fish alarm off. (Note: If the Fish ID feature is off, it will be turned on when you turn the fish alarm on.)

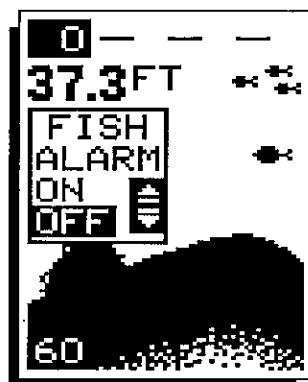

### DEPTH ALARMS

The depth alarms are triggered only by the bottom signal. No other echoes will activate these alarms. The depth alarms consist of a shallow and deep alarm. The shallow alarm sounds an alarm tone when the bottom goes shallower than the alarm's setting. The deep alarm sounds a tone when the bottom goes deeper than its setting. Both alarms adjust the same, although through different menus.

### Shallow Alarm

To set the shallow alarm, press the menu key repeatedly until the "SHAL ALARM" menu appears as shown below left. Press the down arrow key to increase the depth, the up arrow key decreases it. The number in the shallow alarm's menu box shows the current shallow alarm setting. When the number reaches the desired setting, release the arrow key. Press the ON/CLEAR key to remove the shallow alarm menu from the screen. Now when the bottom depth goes shallower than the alarm's setting an alarm tone sounds. At the same time the alarm sounds, a message box appears on the screen as shown below right.

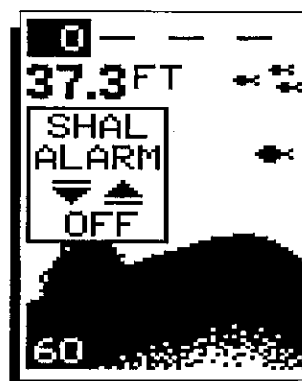

Press the up arrow key to silence the alarm. This will turn the alarm sound off until the shallow alarm is triggered again.

To turn the alarm off, press the menu key until the shallow alarm menu appears. Then press the up arrow key until the word "OFF" appears.

### Deep Alarm

The deep alarm adjusts the same as the shallow alarm. Use the "DEEP ALARM" menu to adjust the deep alarm. When the bottom signal goes deeper than the setting, an alarm tone sounds.

## Free Manuals Download Website

<http://myh66.com>

<http://usermanuals.us>

<http://www.somanuals.com>

<http://www.4manuals.cc>

<http://www.manual-lib.com>

<http://www.404manual.com>

<http://www.luxmanual.com>

<http://aubethermostatmanual.com>

Golf course search by state

<http://golfingnear.com>

Email search by domain

<http://emailbydomain.com>

Auto manuals search

<http://auto.somanuals.com>

TV manuals search

<http://tv.somanuals.com>