



Chain Saw

Instruction Manual

MODELS : CS-330T
CS-360T

WARNING **DANGER**



The muffler or catalytic muffler and surrounding cover may become extremely hot.

Always keep clear of exhaust and muffler area, otherwise serious personal injury may occur.



WARNING

The engine exhaust from this product contains chemicals known to the State of California to cause cancer, birth defects or other reproductive harm.



WARNING **DANGER**

Read rules for safe operation and instructions carefully. ECHO provides an Instruction Manual and a Safety Manual. Both must be read and understood for proper and safe operation.

X7503242004

X750007744
06/06

RULES FOR SAFE OPERATION

A. Kickback Safety Precautions for Chain Saw Users

WARNING!

KICKBACK may occur when the nose or tip of the guide bar touches an object, or when the wood closes in and pinches the saw chain in the cut.

Tip contact in some cases may cause a lightning fast reverse REACTION, Kicking the guide bar up and back towards the operator. Pinching the saw chain along the top of the guide bar may push the guide bar rapidly back towards the operator. Either of these reactions may cause you to lose control of the saw which could result in serious personal injury.

The Kick Guard[®] device is not installed on the guide bar when you purchase your ECHO chain saw. The Kick Guard[®] can be used in a majority of cutting operations, and is especially recommended for beginners, homeowners, or chain saw novices. Most cutting operations can be accomplished with the Kick Guard[®] in place.

Do not rely exclusively upon the safety devices built into your saw. As a chain saw user, you should take several steps to keep your cutting jobs free from accident or injury.

1. With a basic understanding of kickback, you can reduce or eliminate the element of surprise. Sudden surprise contributes to accidents.
2. Keep a good firm grip on the saw with both hands, the right hand on the rear handle, and the left hand on the front handle, when the engine is running. Use a firm grip with thumbs and fingers encircling the chain saw handles. A firm grip will help you reduce kickback and maintain control of the saw. Don't let go.
3. Make sure that the area in which you are cutting is free from obstructions. Do not let the nose of the guide bar contact a log, branch, or any other obstruction which could be hit while you are operating the saw.
4. Cut at high engine speeds.
5. Do not overreach or cut above shoulder height.
6. Follow manufacturer's sharpening and maintenance instructions for the saw chain.
7. Only use replacement bars and chains, or the equivalent, specified by the manufacturer.

B. Other Safety Precautions

1. Do not operate a chain saw with one hand! Serious injury to the operator, helpers, bystanders, or any combination of these persons may result from one-handed operation. A chain saw is intended for two-handed use.
2. Do not operate a chain saw when you are fatigued.
3. Use safety footwear; snug-fitting clothing; protective gloves; and eye, hearing and head protection devices. Wear protective hair covering to contain long hair.
4. Use caution when handling fuel. Move the chain saw at least 3 m (10 feet) from the fueling point before starting the engine.
5. Do not allow other persons to be near the chain saw when starting or cutting with the chain saw. Keep bystanders and animals out of the work area.
6. Do not start cutting until you have a clear work area, secure footing, and a planned retreat path from the falling tree.

7. Keep all parts of your body away from the saw chain when the engine is running.
8. Before you start the engine, make sure that the saw chain is not contacting anything.
9. Carry the chain saw with the engine stopped, the guide bar and saw chain to the rear, and the muffler away from your body.
10. Do not operate a chain saw that is damaged, improperly adjusted, or not completely and securely assembled. Be sure that the saw chain stops moving when the throttle control trigger is released.
11. Shut off the engine before setting the chain saw down.
12. Use extreme caution when cutting small size brush and saplings because slender material may catch the saw chain and be whipped toward you or pull you off balance.
13. When cutting a limb that is under tension, be alert for spring back so that you will not be struck when the tension in the wood fibers is released.
14. Keep the handles dry, clean, and free of oil or fuel mixture.
15. Operate the chain saw only in well-ventilated areas.
16. Do not operate a chain saw in a tree unless you have been specifically trained to do so.
17. All chain saw service, other than the items listed in the Instruction Manual maintenance instructions, should be performed by competent chain saw service personnel. (For example, if improper tools are used to remove the flywheel or if an improper tool is used to hold the flywheel in order to remove the clutch, structural damage to the flywheel could occur and could subsequently cause the flywheel to burst.)
18. When transporting your chain saw, use the appropriate guide bar scabbard.
19. Spark arrestor mufflers approved to SAE Standard J335b are Standard on ECHO Chain saws to reduce the possibility of forest fires. Do not operate the chain saw with a loose or defective muffler. Do not remove the spark arrestor screen.

WARNING DANGER

- During operation, the muffler or catalytic muffler and surrounding cover become hot.
- Never suspend the saw on a lanyard with the engine running.
- Always use the saw from the right-hand side of your body – **NEVER** from the left side.
- Always wear proper safety clothing to protect your lower body from sharp saw chain and hot muffler.
- Always keep exhaust area clear of flammable debris during transportation or when storing, otherwise serious property damage or personal injury may result.













WARNING DANGER

Using improper replacement components or removing safety devices may result in serious or fatal injury.

CONTENTS

	Page
Rules for Safe Operation	2
Technical Data	5
Emission Data	6
Description	6
Nomenclature of Parts	7
Preparation for Use	8
Fuel and Lubricant.....	10
Operation	11
Starting Cold Engine	11
Starting Warm Engine	12
Stopping	12
Cutting Instructions	13
Maintenance and Care	16
Chain and Guide Bar Combinations	19
Setting the Saw Chain	20
Troubleshooting	21
Storage	24
Correct Use of Chain Brake	24
Servicing Information	28

INTERNATIONAL SYMBOLS

Symbol form/shape	Symbol description/application	Symbol form/shape	Symbol description/application
	Read and understand Operator's Manual.		Chain oil fill
	Wear eyes, ears and head protection		Chain oil pump
	Chain brake operation		Chain oiler adjustment
	Emergency stop		Carburetor adjustment - Low speed mixture
	Choke control "Cold Start" position (choke closed)		Carburetor adjustment - High speed mixture
	Gasoline and oil mixture		Carburetor adjustment - Idle speed

TECHNICAL DATA

Model			CS-330T	CS-360T
Dimension	L x W x H	mm	277 x 247 x 214	
		inch	10.9 x 9.7 x 8.4	
Weight	Power head, dry	kg	3.6 (7.9 lb)	
			Without chain and guide bar	
Engine	Type		Air-cooled, two-stroke, single cylinder	
	Displacement		32.6 (1.989 cu.in.)	36.3 (2.215 cu.in.)
	Carburetor Ignition Spark Plug Starter Power transmission		Diaphragm type Flywheel magneto : CDI system NGK BPM-8Y - .065 mm (.026 in.) Gap Recoil starter Automatic centrifugal clutch	
Fuel	Mixture ratio		50:1 ratio with Echo Power Blend™ 2-stroke oil. 89 octane unleaded. Do not use fuel containing methyl alcohol, more than 10% ethyl alcohol or 15% MTBE.	
	Tank Capacity	ml	310 (10.5 U.S. fl oz.)	
Oil	Bar and chain		ECHO bar and chain oil (or motor oil)	
	Tank Capacity	ml	290 (9.8 U.S. fl oz.)	
	Lubrication		Adjustable automatic oil pump	
Guide bar	Standard		14 in.	16 in.
Saw chain	Optional		12, 16 in.	12, 14 in.
Standard features			Top Handle Front hand guard Anti-vibration device Throttle control lockout Chain catcher Spark arrestor catalytic muffler	
Engine RPM	Idle		2,400 - 2,800	
	Wide Open Throttle (WOT)		13,500 - 14,500	
Kickback Safety Features			Double Guard Low Kick Guide Bar Low Kick Guard Link Saw Chain Front Hand Guard/Chain Brake Lever Chain Brake Kick Guard	

* Technical data subject to change without notice.

EMISSION DATA

EMISSION CONTROL



EPA Phase 2

The emission control system for these engines are EM/TWC (Engine Modification and Catalyst).

An Emission Control Label is located on the engine. (This is an EXAMPLE ONLY, information on label varies by engine FAMILY).

IMPORTANT ENGINE INFORMATION

ENGINE FAMILY: 6EXHS.0334KB DISPLACEMENT: 32.6 cc
EMISSION COMPLIANCE PERIOD: 300 HOURS
THIS ENGINE MEETS U.S. EPA PH2 AND 2005 - 2006 CALIFORNIA EMISSION REGULATIONS FOR SORES.
REFER TO OWNER'S MANUAL FOR MAINTENANCE SPECIFICATIONS AND ADJUSTMENTS.

 **ECHO CORP.** 

PRODUCT EMISSION DURABILITY

The 300 hour emission durability compliance period is the time span selected by the manufacturer certifying the engine emissions output meets applicable California and/or U.S. EPA emissions regulations, provided that approved maintenance procedures are followed as listed in the Maintenance Section of this manual.

DESCRIPTION

The ECHO product you purchased has been factory pre-assembled for your convenience. Due to packaging restrictions, guide bar and saw chain installation and other assembly may be necessary.

After opening the carton, check for damage. Immediately notify your retailer or ECHO Dealer of damaged or missing parts. Use the contents list to check for missing parts.

CONTENTS

- 1 - Power Head
- 1 - Guide Bar
- 1 - Kick Guard
- 1 - Hex Head Bolt
- 1 - Hex Nut
- 1 - Saw Chain
- 1 - Instruction Manual
- 1 - Safety Manual
- 1 - Warranty Registration Card
- 1 - Limited Warranty Statement
- 1 - T-Wrench
- 1 - Echo Power Blend™ 2-stroke oil sample

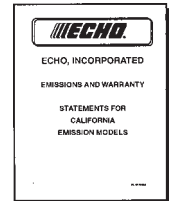

NOMENCLATURE OF PARTS

CS-330T, CS-360T

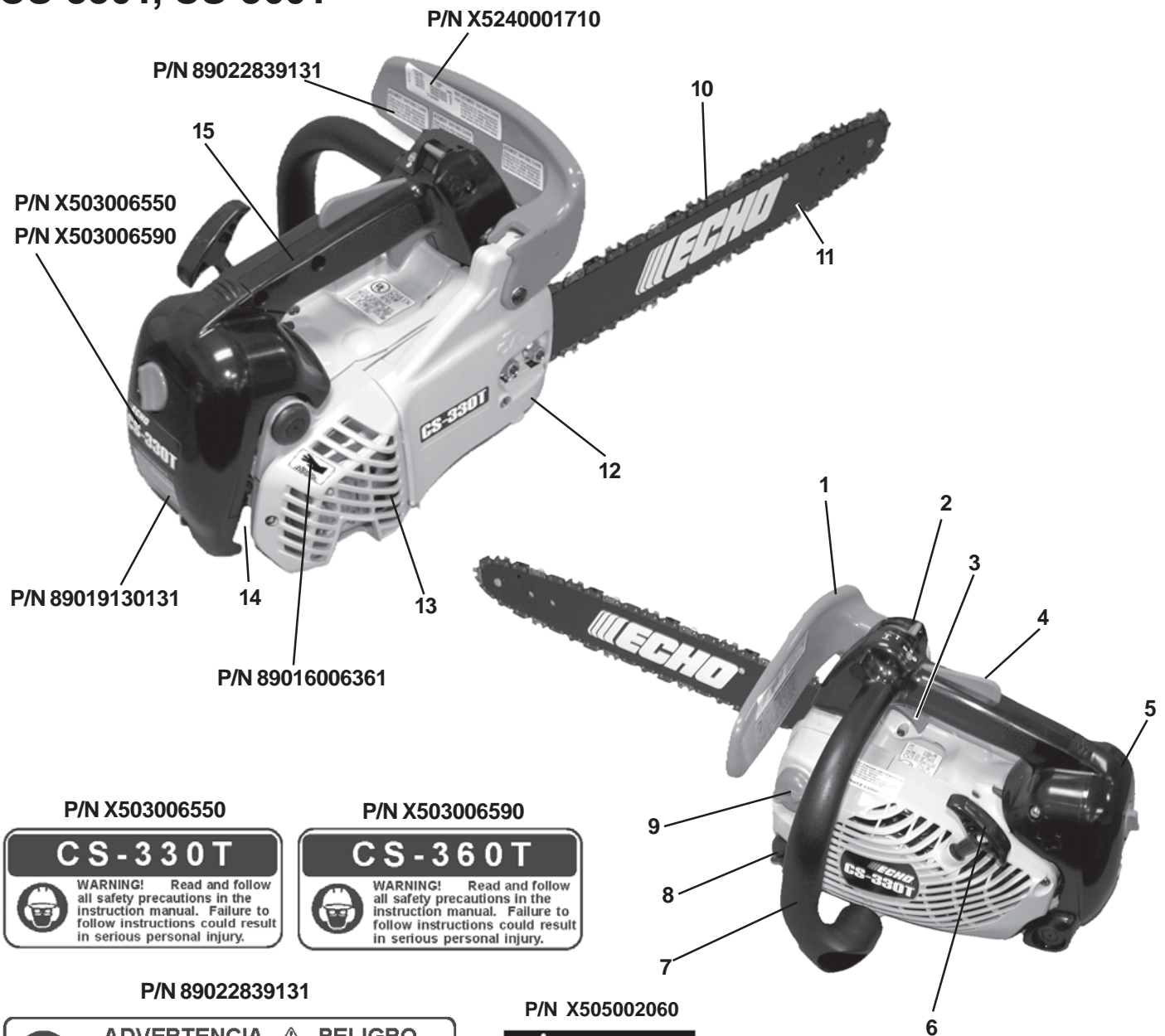

P/N X503006550

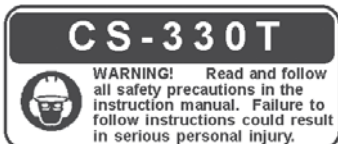

P/N X503006590



P/N 89022839131

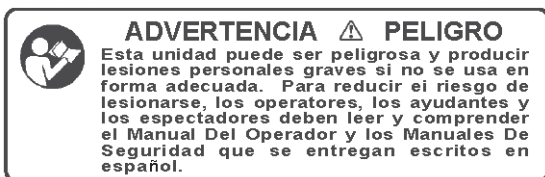

P/N X505002060



P/N X524001710

GUIDE BAR*		CHAIN*		REPLACEMENT BAR AND CHAIN
PART NO.	TYPE	LINKS	Links	
12"	12AOED3745	OREGON 91VG	45	Note: There may be other replacement components for achieving kickback protection. For details, please refer to the chain and bar combination sheet shown in the instruction manual.
14"	14AOED3752	OREGON 91VG	52	
16"	16AOED3757	OREGON 91VG	57	

P/N 89019130131



P/N 89016006361

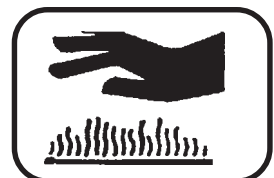

- | | | |
|--|----------------------|--|
| 1. Hand guard
(Chain brake actuating lever) | 5. Air cleaner cover | * If a decal cannot be read, a new one can be ordered from your ECHO dealer. |
| 2. Ignition/Choke Lever | 6. Pull starter | |
| 3. Throttle control trigger | 7. Front handle | 10. Saw chain |
| 4. Throttle control lockout | 8. Oil tank cap | 11. Guide bar |
| | 9. Fuel tank cap | 12. Sprocket guard |
| | | 13. Catalytic muffler |
| | | 14. Spark Plug |
| | | 15. Rear (Top) Handle |

PREPARATION FOR USE

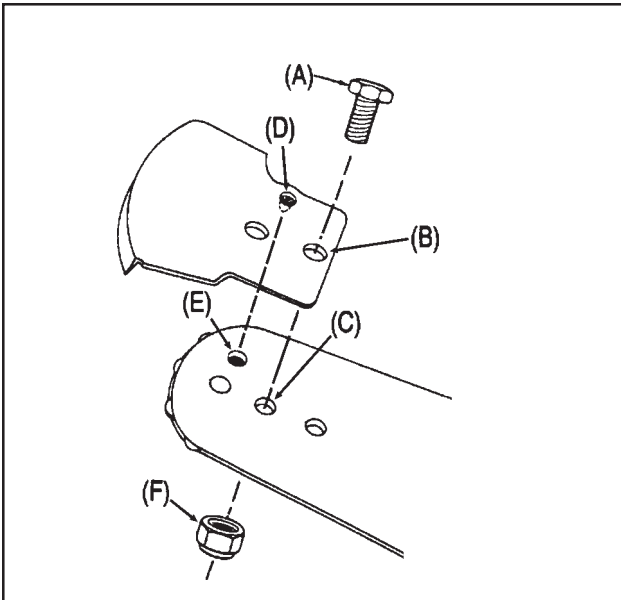

KICK GUARD® TO BAR INSTRUCTIONS

For saws with Kick Guard® P/N 2894901 and symmetrical or asymmetrical low-kick type guide bars.

1. Install bolt (A) in **rear** hole (B) of Kick Guard® and through front hole (C) in guide bar.
2. **IMPORTANT:** Dimple in Kick Guard® (D) must engage recess in guide bar (E).
3. Tighten nut (F) and bolt (A) until snug. Make certain Kick Guard® is flush against guide bar.

GUIDE BAR AND SAW CHAIN-INSTALL/REMOVE

WARNING DANGER

Saw Chain is sharp! Always wear gloves when handling assembly, otherwise serious personal injury may result.

1. Move chain brake lever (G) fully rearward to unlock chain brake.

IMPORTANT

Always loosen guide bar nuts before turning chain tension adjuster, otherwise clutch cover and tensioner will be damaged.

2. Remove two guide bar nuts (H). Turn tension adjustment screw (J) counterclockwise 2 to 3 turns if bar and chain are installed.
3. Push clutch cover (K) forward, pull rear of cover out slightly, then remove.
4. Remove guide bar and saw chain if necessary.

NOTE: See "MAINTENANCE AND CARE" instructions for guide bar, sprocket, and saw chain maintenance.

5. Mount guide bar (L) on studs, and slide toward sprocket to make saw chain installation easier. Install saw chain (M) over clutch and place around sprocket and guide bar as shown, with cutters on top of guide bar facing forward.
6. Align holes of clutch cover (K) with guide bar studs, and tensioner pin (N) with lower guide bar adjuster hole. Install cover, then press and hold rear of cover to fully seat. Tighten guide bar nuts finger tight.

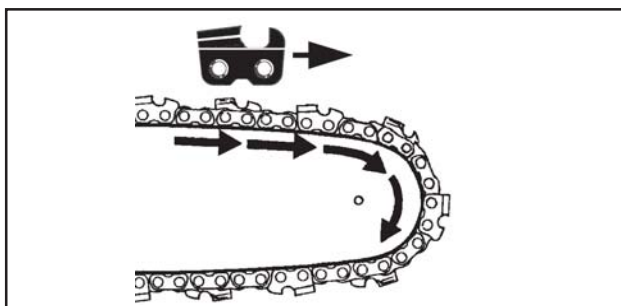
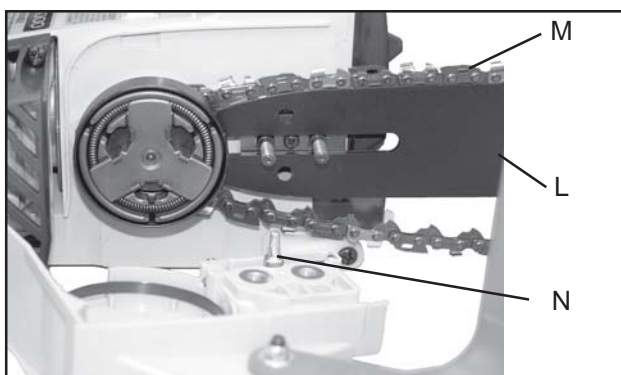
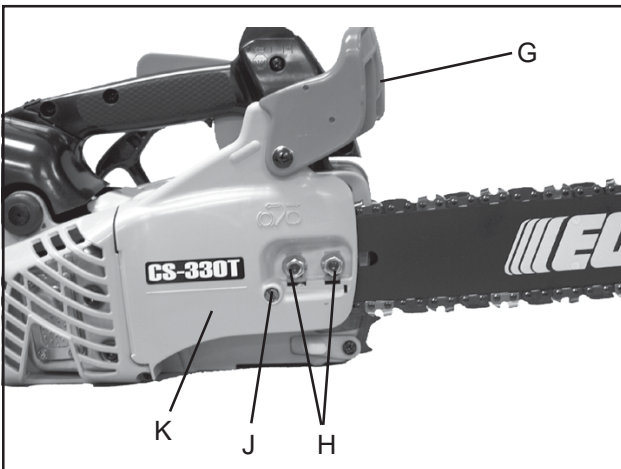

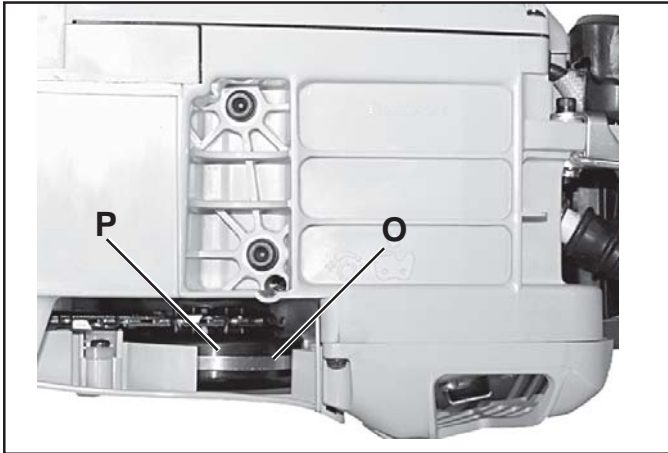

- Turn saw over and check brake band (O) for correct position around clutch drum (P). If brake band is not in place around drum, remove clutch cover, make sure brake is released, and reinstall.

⚠ DANGER

Never operate saw if chain brake does not function properly, otherwise saw damage and serious personal injury could result. See “Testing the Brake” instructions.

- Adjust saw chain tension, as instructed in “Adjustment, Chain Tension”

ADJUSTMENT, CHAIN TENSION

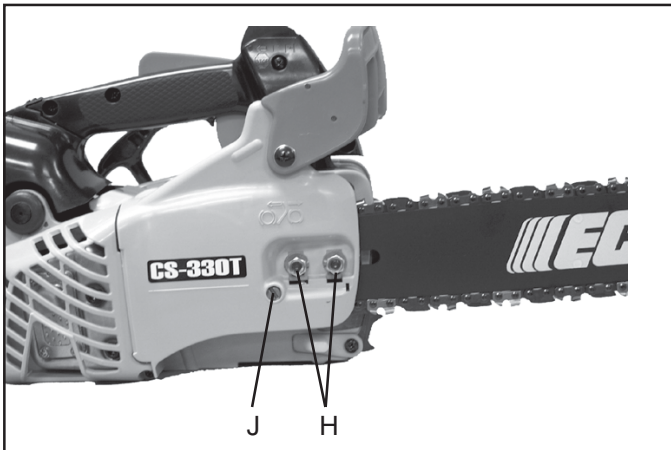

IMPORTANT

Always loosen guide bar nuts before turning chain tension adjuster, otherwise clutch cover and tensioner will be damaged.

- Remove air filter cover and spark plug lead.
- Loosen two guide bar nuts (H).
- Hold the bar nose up, and turn the adjuster screw (J) clockwise until the chain touches the bottom of the bar.
- Tighten both guide bar nuts with bar nose held up.



IMPORTANT!

Tighten guide bar nuts to 90 – 110 kgf/cm (80 – 95 in. lbs.) DO NOT over-tighten nuts. Damage to saw may result.

- Pull the saw chain around the guide bar by hand. Reduce chain tension, if you feel tight spots.

NOTE

All chains require frequent adjustments.

- Keep chain properly tensioned at all times.
- Replace spark plug lead and air filter cover.

FUEL AND LUBRICANT

NOTICE: Use of unmixed, improperly mixed, or fuel older than 90 days, (stale fuel), may cause hard starting, poor performance, or severe engine damage and void the product warranty. Read and follow instructions in the Storage section of this manual.

FUEL STATEMENT

GASOLINE - Use 89 Octane [R+M/2] (mid grade or higher) gasoline or gasohol known to be good quality. Gasohol may contain up to 10% Ethyl (grain) alcohol or 15% MTBE (methyl tertiary-butyl ether). Gasohol containing methyl (wood) alcohol is **NOT** approved.

Two Stroke Oil - A two-stroke engine oil meeting ISO-L-EGD (ISO/CD 13738) and J.A.S.O. FC Standards must be used. Echo brand premium Power Blend™ Universal 2-Stroke Oil meets these standards. Engine problems due to inadequate lubrication caused by failure to use an ISO-L-EGD and J.A.S.O. FC certified oil, such as Echo premium Power Blend™, will void the two-stroke engine warranty. (Emission related parts only are covered for two years, regardless of two-stroke oil used, per the statement listed in the Emission Defect Warranty Explanation.)

IMPORTANT

Echo premium Power Blend™ Universal 2-Stroke Oil may be mixed at 50:1 ratio for application in all Echo engines sold in the past regardless of ratio specified in those manuals.

Handling Fuel

WARNING DANGER

Fuel is VERY flammable. Use extreme care when mixing, storing or handling or serious personal injury may result.

- Use an approved fuel container.
- DO NOT smoke near fuel.
- DO NOT allow flames or sparks near fuel.
- Fuel tanks/cans may be under pressure. Always loosen fuel caps slowly allowing pressure to equalize.
- NEVER refuel a unit when the engine is HOT or RUNNING!
- DO NOT fill fuel tanks indoors. ALWAYS fill fuel tanks outdoors over bare ground.
- DO NOT overfill fuel tank. Wipe up spills immediately.
- Securely tighten fuel tank cap and close fuel container after refueling.
- Inspect for fuel leakage. If fuel leakage is found, do not start or operate unit until leakage is repaired.
- Move at least 3m (10 ft.) from refueling location before starting the engine.

Fuel Mix Chart

50:1

(U.S.)		(METRIC)	
GAS	OIL	GAS	OIL
Gal.	Fl. oz.	Liter	cc.
1	2.6	4	80
2	5.2	8	160
5	12.8	20	400

Mixing Instructions

1. Fill an approved fuel container with half of the required amount of gasoline.
2. Add the proper amount of 2-stroke oil to gasoline.
3. Close container and shake to mix oil with gasoline.
4. Add remaining gasoline, close fuel container, and remix.

IMPORTANT

Spilled fuel is a leading cause of hydrocarbon emissions. Some states may require the use of automatic fuel shut-off containers to reduce fuel spillage.

After use

- DO NOT store a unit with fuel in its tank. Leaks can occur. Return unused fuel to an approved fuel storage container.

Storage - Fuel storage laws vary by locality.

Contact your local government for the laws affecting your area. As a precaution, store fuel in an approved, airtight container. Store in a well-ventilated, unoccupied building, away from sparks and flames.

IMPORTANT

Stored fuel ages. Do not mix more fuel than you expect to use in thirty (30) days, ninety (90) days when a fuel stabilizer is added.

IMPORTANT

Stored two-stroke fuel may separate. ALWAYS shake fuel container thoroughly before each use.

CHAIN LUBRICANT

Proper lubrication of the chain while in operation reduces friction between the chain and the guide bar to a minimum and assures a longer service life.

- use bar and chain oil of high quality for this purpose.
- Do not use used or reclaimed oil to avoid various oiler problems.
- Use ECHO bar and chain oil.
- When ECHO bar and chain oil is not available: Use motor oil, etc.
- Use bar and chain oil of the following grades:
SAE NO. 30 in summer
SAE NO. 10 in winter or when cutting resinous trees.
- When refueling, also refill chain oil.

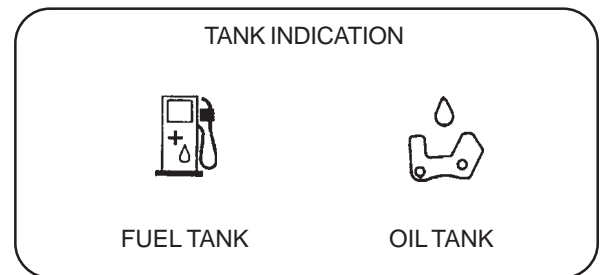

OPERATION

IMPORTANT

This saw features a combination ignition/choke switch that automatically sets the throttle speed to fast idle for quick starting. Do not squeeze trigger during cold starts until after unit has started, or fast idle and choke settings will be released, and engine may not start.

STARTING COLD ENGINE

WARNING DANGER

Make sure bar and chain are not touching anything when starting the saw.

1. Move chain brake lever (E) fully forward to lock chain brake before starting.
2. Fill the fuel tank with fuel. Do not over fill.
3. Fill the chain oil tank with lubricant. Do not over fill.
4. Move ignition/choke lever (A) forward to “close choke” () position.
5. Lay unit on a flat, clear area and keep bar and chain clear of all obstacles. Hold top handle with one hand, and depress throttle trigger lockout (C), but do not depress throttle trigger (D).
6. Pull starter handle (F) several times until engine starts, or first starting sound is heard. (7 pulls maximum)
7. Move ignition/choke lever back to “run” (I) position (B). (Do not move to “Stop” position.) If necessary, start the engine.

NOTE

If engine does not start after 3 pulls with choke in “run” (I) position, repeat cold start instructions 4-6.

8. After engine starts, wait 5 seconds then depress and release throttle trigger (D). Allow unit to warm up at idle for several minutes.

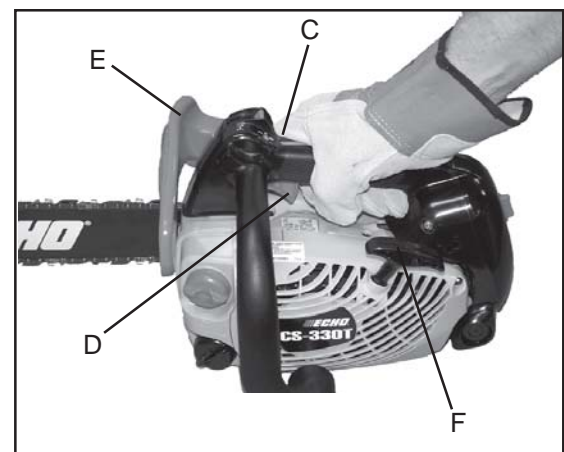
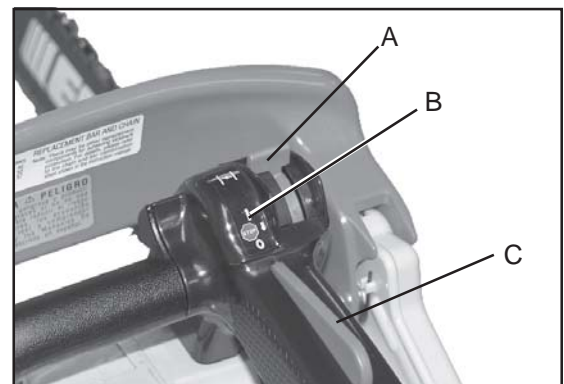

NOTE

Do not pull starter rope out to the maximum possible position.
Do not allow recoil handle to snap back against the casing.

STARTING WARM ENGINE

1. Ensure that there is fuel and chain oil in the tanks.
2. Move chain brake lever (E) fully forward to lock chain brake before starting.
3. Lay unit on a flat, clear area and keep bar and chain clear of all obstacles. Hold top handle with one hand, and depress throttle trigger lockout, but do not depress throttle trigger.
4. Move ignition/choke lever (A) forward to "Run" position (I).
5. Pull starter handle.

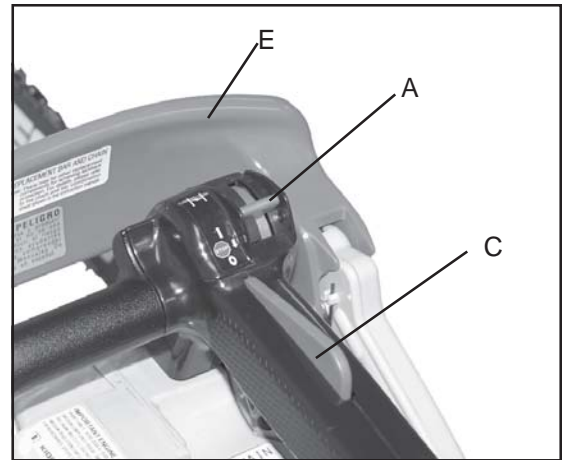

NOTE

If engine does not start after 5 pulls, use cold start procedure.

RUNNING

WARNING DANGER

The saw chain should not move at idle, otherwise serious personal injury may result.

NOTE

If saw chain moves, adjust carburetor according to "Carburetor Adjustment" instructions in this manual, or see your dealer.

- After engine starts, allow it to return to idle and warm up before using.
- Move chain brake lever fully rearward to unlock chain brake.
- Press throttle control lockout then gradually squeeze throttle trigger to increase engine speed.
- Saw chain starts moving when the engine reaches approximately 4200 rpm.
- Ensure proper acceleration and lubrication of chain and bar.
- Do not run the engine at high speed unnecessarily.
- Be sure that saw chain stops moving when throttle trigger is released.

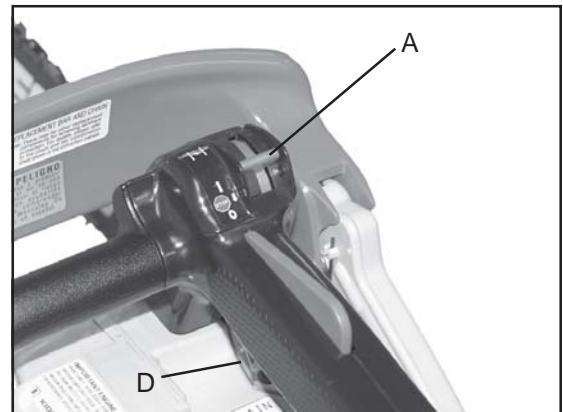

STOPPING

1. Release throttle trigger (D) and move lever (A) rearward to STOP (O) position.
2. Move chain brake lever (E) fully forward to lock chain brake.

NOTE

If engine does not stop, move ignition/choke lever forward to choke position () to stop engine. Return the unit to your authorized ECHO dealer to check and repair stop switch before starting the engine again.

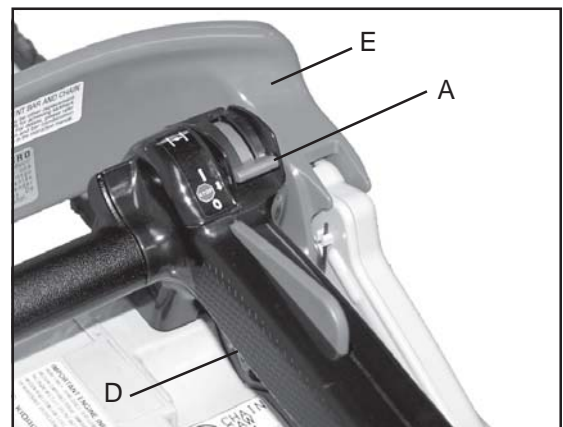

CUTTING INSTRUCTIONS

GENERAL

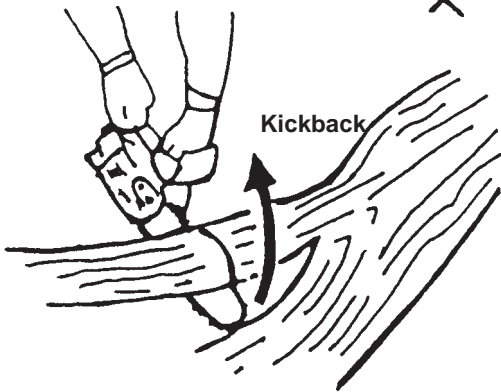
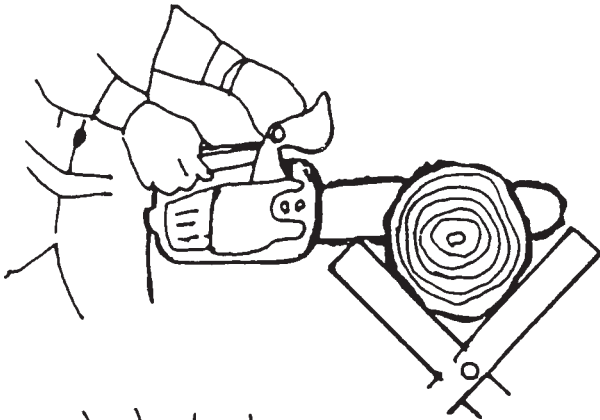
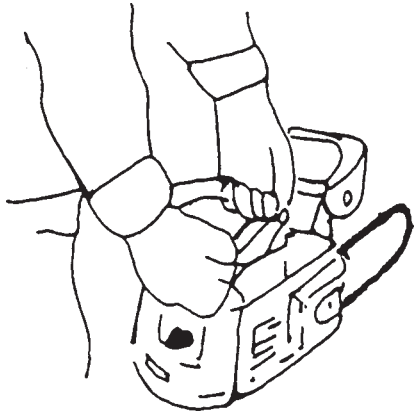

WARNING DANGER

Read the ECHO "CHAIN SAW SAFETY MANUAL" included with your chain saw for additional cutting and safety instructions. Failure to obey all instructions may result in serious or fatal injuries.

In all circumstances the operation of the chain saw is a one-man job. It is difficult at times to take care for your own safety, so don't assume the responsibility for a helper as well. After you have learned the basic techniques of using the saw, your best aid will be your own good common sense...

The accepted way to hold the saw is to stand to the left of the saw with your left hand on the front handlebar and your right hand on the rear handle so you can operate the throttle trigger with your right index finger.

Before attempting to fell a tree, cut some small logs or limbs. Become thoroughly familiar with the controls and the responses of the saw.

Start the engine, see that it is running properly. Squeeze the trigger to open the throttle wide open and start the cut. If the chain is properly sharpened, the cutting should be relatively effortless. It is not necessary to press down hard to make the saw cut. Pushing the saw too hard will slow the engine and cutting will actually be more difficult.

NOTE

Some material may adversely affect the housings of your ECHO chain saw.

(Example: Palm Tree Acid, fertilizer, etc.) To avoid housing deterioration, carefully remove all packed saw dust around clutch and guide bar area and wash with water. Coat metal parts with light oil.

WARNING DANGER

Do not let the tip of the bar touch anything while the engine is running. At cutting speed the chain is moving at a high rate of speed. Should the tip contact a limb or log while the chain is moving, the tip will be pushed upward with considerable force. This is known as kickback. Avoid it!

FELLING A TREE

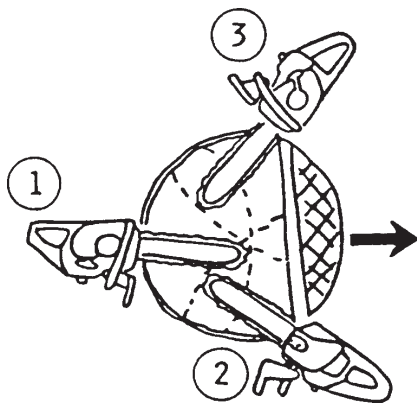
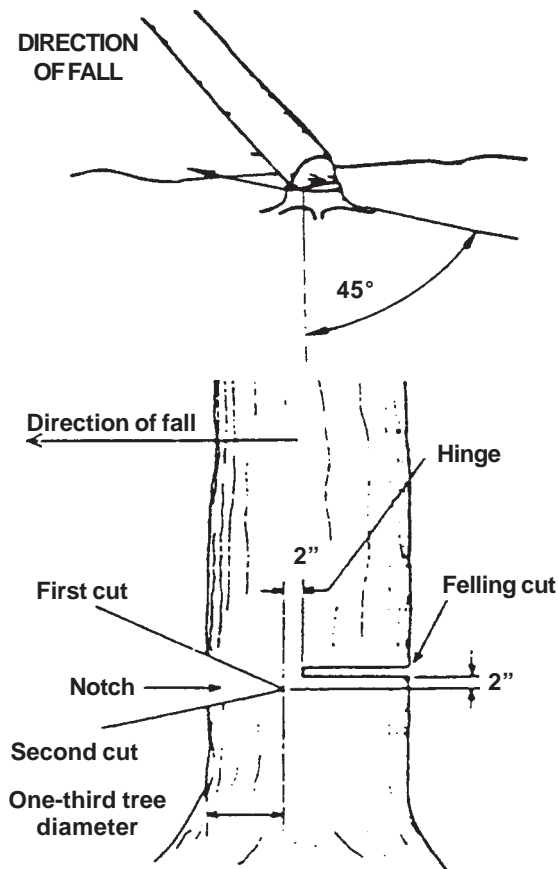

LIMBING

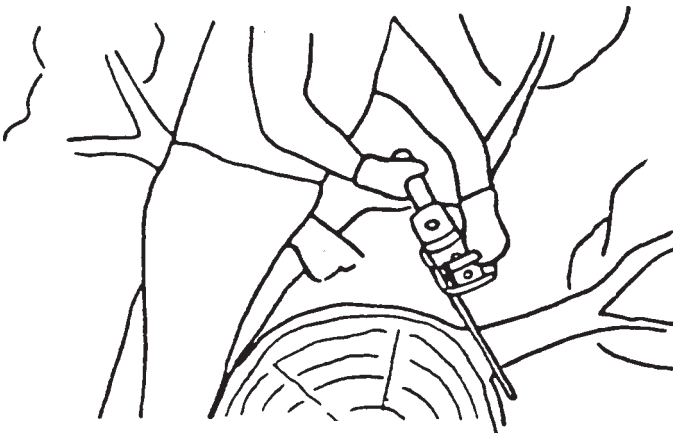

WARNING DANGER

A falling tree can seriously damage anything it may hit - a car, a house, a fence, a power line, or another tree. There are ways to make a tree fall where you want it, so first decide where that is!

Before cutting, clear the area around the tree. You will need good footing while working and you should be able to work the saw without hitting any obstacles. Next, select a path of retreat. When the tree begins to fall you should retreat away from the direction of fall at a 45 degree angle and at least 3m from the trunk to avoid the trunk kicking back over the stump.

Begin the cut on the side to which the tree is to fall. Cut a notch about 1/3 of the way into the tree as shown. The position of this notch is important since the tree will try to fall "into" the notch. The felling cut is made on the side opposite the notch and at a level about 2" above the bottom of the notch. Do not try to cut through to the notch with the felling cut. The remaining wood between the notch cut and felling cut (about 2") will act as a hinge when the tree falls, guiding it in the desired direction. When the tree starts to fall, kill the engine, place the saw on the ground and make your retreat quickly.

To fell big trees with a diameter exceeding twice the bar length, start the notching cuts from one side and draw the saw through to the other side of the notch. Start the back cut on one side of the tree, pivoting the saw through to form the desired hinge on that side.

Then remove the saw for the second cut. Insert the saw in the first cut, very carefully so as not to cause kickback. The final cut is made by drawing the saw forward in the cut to reach the hinge.

Limbing a fallen tree is much the same as bucking. Never limb on the tree that you are standing. When limbing, caution is the word. Be careful of the tip touching other limbs. Always use both hands.



Don't cut with the saw overhead or the bar in a vertical position. If the saw should kick back you may not have good enough control to prevent possible injury.

Uphill position

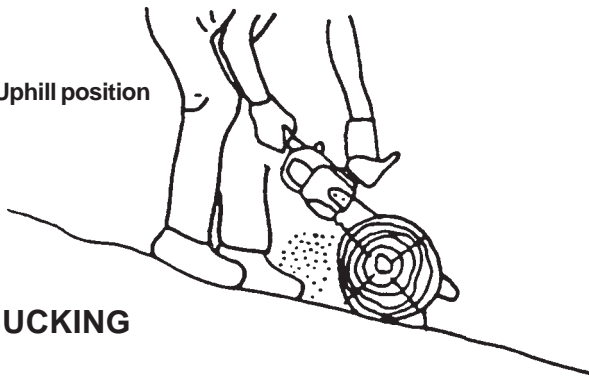

BUCKING

Bucking is the sawing of a log or fallen tree into smaller pieces. There are a few basic rules which apply to all bucking operations.

Keep both hands on the handles at all times.

Support logs if possible.

When cutting on a slope or hillside, always stand uphill.

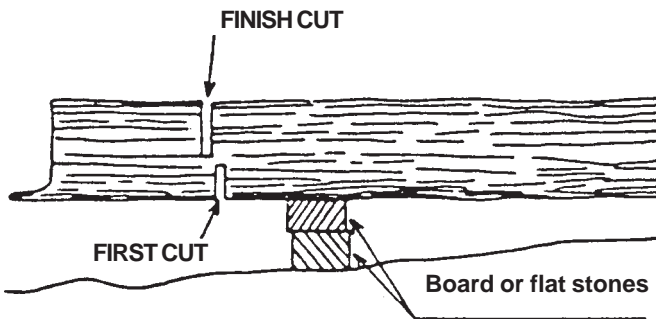

Keep in mind that the wood is heavy and that it will bend and pinch the saw if improperly supported.

The trunk will weaken at the point where you make the cut unless the tree is lying on perfectly flat ground or supported as shown.

If you make the cut with the tree on the ground, don't let the saw's chain dig into the earth; it is harmful for the saw, and you stand a good chance of being struck by flying debris. To cut the trunk, use the bucking and two-cut sequence shown. The first cut should be no deeper than one-third the trunk diameter.

KICKBACK

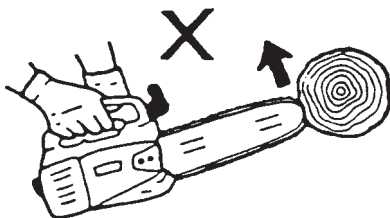

Improper thrust cutting.

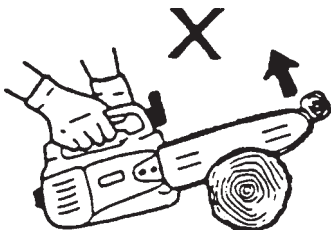

When the bar nose hits another tree, etc.

WARNING  **DANGER**

KICKBACK IS DANGEROUS

Kickback is generated when the rotation of the chain is arrested for some reason. The most dangerous effect of this action occurs when the nose of the bar contacts another object, the chain is momentarily stopped and all the energy of the engine throws the bar upwards and backwards towards the operator.

The chain saw industry and government agencies have attempted to prescribe various safety devices, but the best protection is to avoid kickback.

Comply with the Safety Precautions as listed on page 2 and 3 of this manual.

MAINTENANCE AND CARE

Your ECHO unit is designed to provide many hours of trouble free service. Regular scheduled maintenance will help your unit achieve that goal. If you are unsure or are not equipped with the necessary tools, you may want to take your unit to an ECHO Service Dealer for maintenance. To help you decide whether you want to DO-IT-YOURSELF or have the ECHO Dealer do it, each maintenance task has been graded. If the task is not listed see your Echo dealer for repairs.

SKILL LEVELS

- Level 1** = Easy to do. Most required tools come with unit.
- Level 2** = Moderate difficulty. Some specialized tools may be required.
- Level 3** = Experience required. Specialized tools are required. ECHO recommends that the unit be returned to your ECHO dealer for servicing.

ECHO offers **REPOWER™** Maintenance Kits and Parts to make your maintenance job easier. Just below each task heading are listed the various part numbers required for that task. See your ECHO dealer for these parts.

MAINTENANCE INTERVALS

COMPONENT/ SYSTEM	MAINTENANCE PROCEDURE	REQ'D SKILL LEVEL	DAILY OR BEFORE USE	EVERY REFUEL	3 MONTHS OR 90 HOURS	6 MONTHS OR 270 HOURS	YEARLY 600 HOURS
Recommended Echo Dealer Maintenance Procedures							
Cylinder Exhaust Port	Inspect/Clean/Decarbon	3			I / C		
Do-It-Yourself Maintenance Procedures							
Air Filter	Inspect/Clean/Replace	1	I / C		R *		
Automatic Oiler	Inspect/Adjust	1	I				
Oil Strainer	Inspect/Replace	1	I / R *				
Fuel Strainer	Inspect/Replace	1			I		R *
Guide Bar & Oil Holes	Inspect/Clean	1	I / C				
Sprocket	Inspect/Replace	2	I / R *				
Spark Plug	Inspect/Clean/Replace	2			I / C	R *	
Cooling System	Inspect/Clean	2	I / C				
Muffler Spark Arrestor	Inspect/Clean/Replace	2			I / R *		
Recoil Starter Rope	Inspect/Replace	1	I / R *				
Screws/Nuts/Bolts	Inspect/Tighten/Replace	1	I / R *				
<p>MAINTENANCE PROCEDURE LETTER CODES: I = INSPECT, R = REPLACE, C = CLEAN IMPORTANT NOTE - Time intervals shown are maximum. Actual use and your experience will determine the frequency of required maintenance. MAINTENANCE PROCEDURE NOTES: * All recommendations to replace are based on the finding of damage or wear during inspection..</p>							

AIR FILTER

1. Close choke (Cold Start Position []). This prevents dirt from entering the carburetor throat when the air filter is removed. Brush accumulated dirt from air cleaner area.
2. Remove air filter cover. Brush dirt from inside cover.
3. Remove air filter and lightly brush debris from filter. Replace filter if it is damaged, fuel soaked, very dirty, or deformed.
4. Install air filter cover.



AUTOMATIC OILER

- The discharge volume of the automatic oiler is adjusted to 6 to 7 cc/min (@ 7000 rpm) prior to shipment from the factory.
- Always check oil discharge when in use.
- Turn adjusting screw (D) counter-clockwise to increase oil volume, clockwise to decrease oil volume.



OIL STRAINER

- Check periodically.
 1. Do not allow dust to enter oil tank.
 2. Clogged oil strainer will affect the normal lubricating system
 3. Using a wire bent into the shape of a hook, pull strainer out through oil port and inspect strainer.
 4. If the strainer is dirty, clean with suitable cleaning fluid.
 5. If the inside of the oil tank is dirty, rinse with suitable cleaning fluid.



FUEL STRAINER

1. Do not allow dust to enter fuel tank.
2. Clogged strainer will cause difficulty in starting engine or abnormalities in engine performance.
3. Using a wire bent into the shape of a hook, pull strainer out through gas port, and inspect strainer.
4. If the strainer is dirty, clean with suitable cleaning fluid.
5. If the inside of the tank is dirty, rinse with suitable cleaning fluid.



GUIDE BARS AND OIL HOLES

- Follow instructions for "Guide Bar and Saw Chain – Install/Remove".
- Clean after each use
 - Clean the grooves (A) of the guide bar with a small screwdriver.
 - Clean oil holes (B) with a wire.

NOTE: Symmetrical shaped Guide Bars should be inverted each time the chain is removed to extend guide bar life.

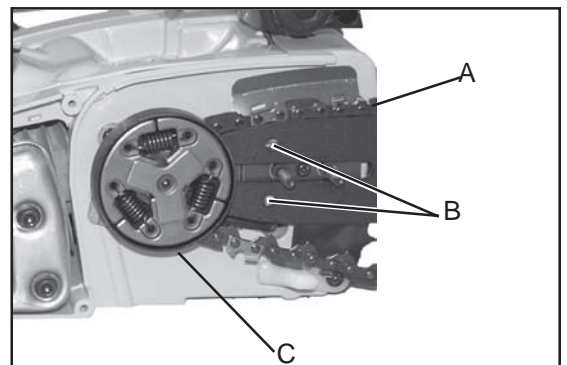

SPROCKET

- A damaged sprocket (C) will cause premature damage or wear of saw chain.
- Clean sprocket, clutch and bar mount area before installation of bar.
- Check sprocket when you install new chain. When outer diameter of sprocket is worn 0.5mm (.020") or more, replace it.

IMPORTANT

Some tree sap and resins are corrosive. Thoroughly wash the guide bar and sprocket areas after each use, then coat metal parts with light oil.

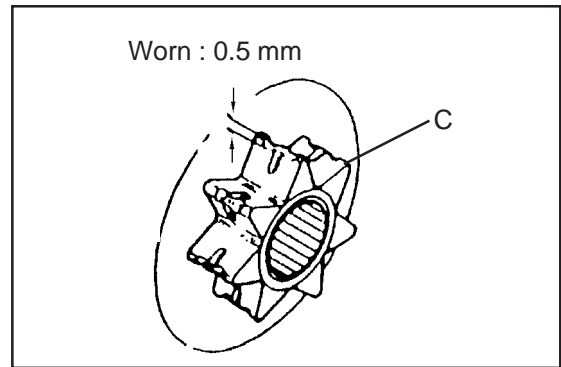

SPARK PLUG

- Check periodically.

IMPORTANT

Use only NGK BPM-8Y spark plug (BPMP-8Y in Canada) otherwise severe engine damage may occur.

1. Remove air cleaner cover.
2. Remove spark plug lead and spark plug.
3. Gap = 0.65 mm (0.026 in)
4. Replace if electrode is worn, or if the insulator is fouled by oil or other deposits
5. Torque = 150 – 170 kg/cm (130 – 150 in. lb.)

IMPORTANT

Do not over-torque

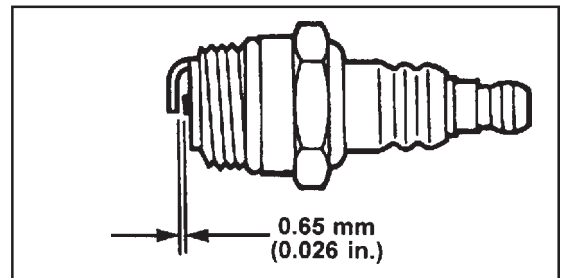

COOLING SYSTEM CLEANING

NOTE

See "Guide Bar and Saw Chain-Install/Remove Instructions for sprocket guard removal/replacement instructions.

Muffler Side

1. Remove air filter cover and remove spark plug lead.
2. Remove two guide bar nuts and remove sprocket guard.
3. Remove three muffler cover screws and remove muffler cover.
4. Using a stiff bristle cleaning brush (do not use a metal brush), remove debris from cylinder fins in muffler area.
5. Assemble components in reverse order



Starter Side

1. Remove air filter cover and remove spark plug lead.
2. Remove plastic plug in side handle mount (D), and remove side handle mounting screw.
3. Remove four starter cover screws and remove starter cover.
4. Using a stiff bristle cleaning brush (do not use a metal brush), remove debris from flywheel and ignition coil area.
5. Assemble components in reverse order.

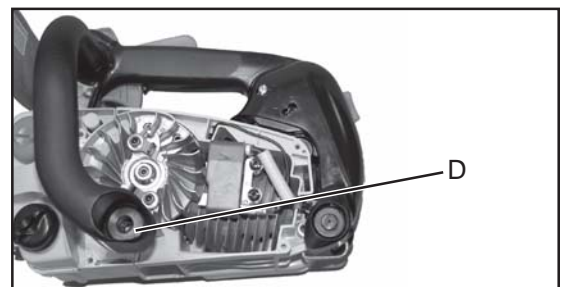

MUFFLER SPARK ARRESTOR

IMPORTANT

Carbon deposits in muffler will cause a drop in engine output and overheating. Spark arrestor screen must be checked periodically.

1. Remove air filter cover and remove spark plug lead.
2. Remove two guide bar nuts and remove sprocket guard.
3. Remove three muffler cover screws and remove muffler cover.
4. Remove spark arrestor screen cover, gaskets, and screen from muffler body.
5. Clean carbon deposits from muffler components.

NOTE

When cleaning carbon deposit, be careful not to damage the catalytic element inside muffler.

6. Replace screen if it is cracked, plugged, or has holes burned through.
7. Assemble components in reverse order.



Cylinder Exhaust Port

IMPORTANT

The cylinder exhaust port must be inspected and cleaned of excess carbon every 3 months or 90 hours of operation in order to maintain this engine within the emissions durability period. ECHO strongly recommends that you return your unit to your ECHO dealer for this important maintenance service.

CARBURETOR ADJUSTMENT

Engine Break-In

New engines must be operated a minimum duration of two tanks of fuel break-in before carburetor adjustments can be made. During the break-in period your engine performance will increase and exhaust emissions will stabilize. Idle speed can be adjusted as required.

BEFORE MAKING ADJUSTMENTS:

- The correct spark plug must be clean and properly gapped.
- The air filter element must be clean and properly installed.
- The muffler spark arrestor screen and exhaust port must be clear of carbon.
- The standard bar and chain combination (see page 4) must be installed to the power head, and properly tensioned.

LOW ALTITUDE ADJUSTMENT

Engines that have been adjusted to operate at high altitudes must be readjusted to operate properly at altitudes below 2000 feet.

1. Start engine and run for several minutes to reach operating temperature.
2. Stop engine.
3. Start engine and turn the high-speed needle (A) rich (CCW) until the engine runs between 13,500 and 14,500 RPM. Then turn the low-speed needle (B) rich (CCW) until the engine does not hesitate when accelerated.

DO NOT REMOVE LIMITER CAPS!

4. Idle Speed Adjustment.
 - Turn "idle" speed adjustment screw (C) CW until the saw chain begins to move, then turn the screw CCW until saw chain stops moving. Turn screw CCW an additional 1/4 turn.
5. Accelerate to full throttle for 2-3 seconds to clear excess fuel from engine then return to idle. Accelerate to full throttle to check for smooth transition from idle to full throttle. If engine stops or stalls after full warm up return the unit to your authorized ECHO dealer for adjustment.

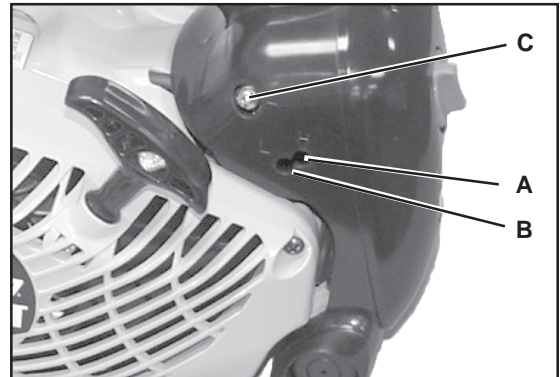

HIGH ALTITUDE ADJUSTMENT

High altitude adjustment may be required for proper operation of this engine above 2000 feet.

1. Start engine and run for several minutes to reach operating temperature.
2. Stop engine.
3. Start engine and turn the HI speed needle (A) lean (CW) until the engine runs between 13,500 and 14,500 RPM. Then turn the LO speed needle lean (B) (CW) until the engine does not hesitate when accelerated.

DO NOT REMOVE LIMITER CAPS!

4. Idle Speed Adjustment.
 - Turn "idle" speed adjustment screw (C) CW until the saw chain begins to move, then turn the screw CCW until saw chain stops moving. Turn screw CCW an additional 1/4 turn.
5. Accelerate to full throttle for 2-3 seconds to clear excess fuel from engine then return to idle. Accelerate to full throttle to check for smooth transition from idle to full throttle. If engine stops or stalls after full warm up return the unit to your authorized ECHO dealer for adjustment.

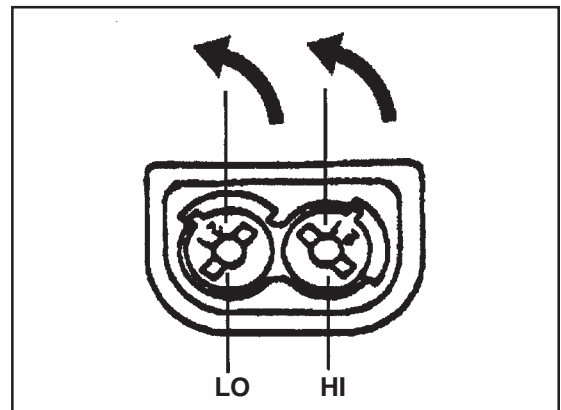

CHAIN AND GUIDE BAR COMBINATIONS

The following combinations may be used on CS-330T and CS-360T.

MODEL	BAR LENGTH	LOW KICKBACK GUARD BAR	LOW KICKBACK SAW CHAIN					KICK GUARD
		BAR P/N	CHAIN PART NO.	LINKS	TYPE	PITCH	GAUGE	ECHO P/N (OEM P/N)
CS-330T	12"	12A0ED3745	91VG-45	45	91VG	3/8"	.050	2894901 28949
CS-360T	14"	14A0ED3752	91VG-52	52				
	16"	16A0ED3757	91VG-57	57				

*Reduced nose radius symmetrical bars (OREGON name — Double Guard)

WARNING DANGER

Use of replacement saw chain and/or guide bar other than that specified, or operation without the "tip guard" in place, may cause severe kickback resulting in serious injury.

Only use saw chain designated as, "LOW-KICKBACK," that meets the ANSI B175.1-2000 Standard when tested on the representative sample of chain saws below 3.8 C.I.P. specified, and the Echo guide bar specified.

IMPORTANT

Chain and guide bar gauge size must be identical. Use Bar/Chain combinations shown in table above.

IMPORTANT

If your kick guard is damaged or lost, contact your Echo dealer for a replacement. For the name of the Echo dealer nearest you, Call: 1-800-432-ECHO (3246) or on the web at www.echo-usa.com.

Refer to your Chain Saw Safety Manual for kick guard application information.

SETTING THE SAW CHAIN

For setting saw chains, round file (4 mm \varnothing : 5/32") and flat file are used.

- To keep correct position and correct angle, use the file holder.
 - Round file and flat file are available from your Echo Dealer.

- File cutters as below.

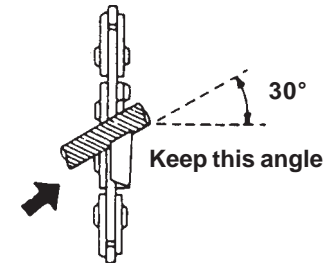

PUSH FILE AS SHOWN

To sharpen other type chain, follow chain manufacturer's instructions

Type : 91VG

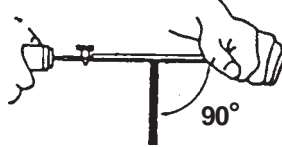

HOLD FILE HOLDER
LEVEL

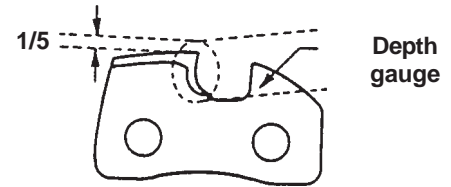

ONE FIFTH OF FILE DIAMETER
REMAINS ABOVE CUTTER EDGE

- Place the depth gauge tool firmly on guide bar so that depth gauge protrudes. Then file top of depth gauge with flat file until flat with top of the gauge tool.
 - Be sure to round off the front edge of the depth gauge.

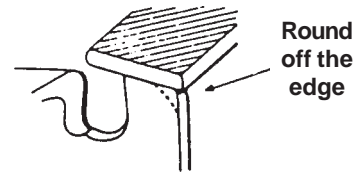
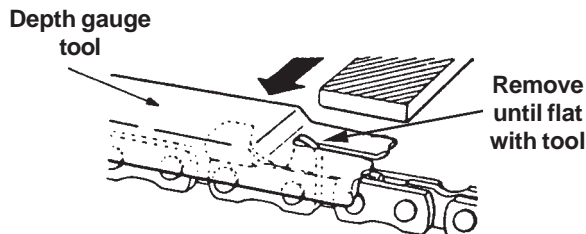

- Properly filed cutters are shown below.

(Top plate angle)

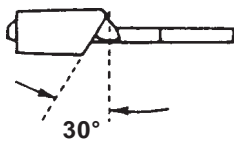

(Side plate angle)

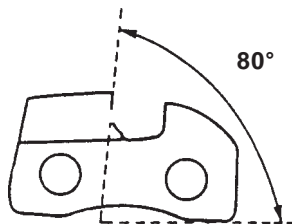

(Top plate cutting angle)

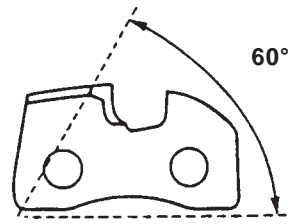

(Depth gauge)

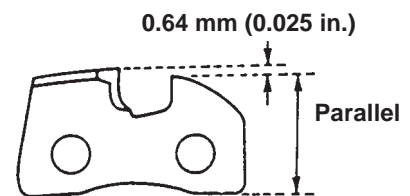

- When setting of the chain is finished, soak it in oil and wash away filings completely before using.
- When chain has been filed on the bar, supply sufficient oil to it, rotate the chain slowly to wash away the filings before using again.
- If the chain saw is operated with filings clogged in the groove, the saw chain and the guide bar will be damaged prematurely
- If the saw chain becomes soiled with resin, for instance, clean it with kerosene and soak it in oil.

CHAIN TYPE AND SPROCKET PITCH

Saw chain should be used with corresponding pitched sprocket. To identify chain type and pitch of sprocket, check as follows.

- Chain type number (A) is stamped on drive link.
- Sprocket pitch (B) is stamped on clutch drum.

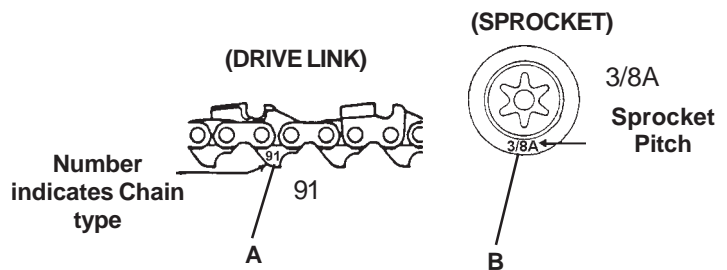

TROUBLESHOOTING

Poor performance of the engine and/or cutting mechanism can normally be prevented by carefully following these instructions.

Poor performance can easily be corrected even by a beginner.

When the engine does not function properly check the following three (3) points first.

- Is the engine compression adequate?
- Is fuel system in good condition and is enough fuel being supplied?
- Is electrical system in good condition and is spark plug operating normally?

When there is serious trouble with the unit, do not try to repair it yourself but have your distributor or dealer do it for you.

For detailed TROUBLESHOOTING refer to tables 1 and 2. Locate the problem on the following charts and repair as necessary.

Table 1

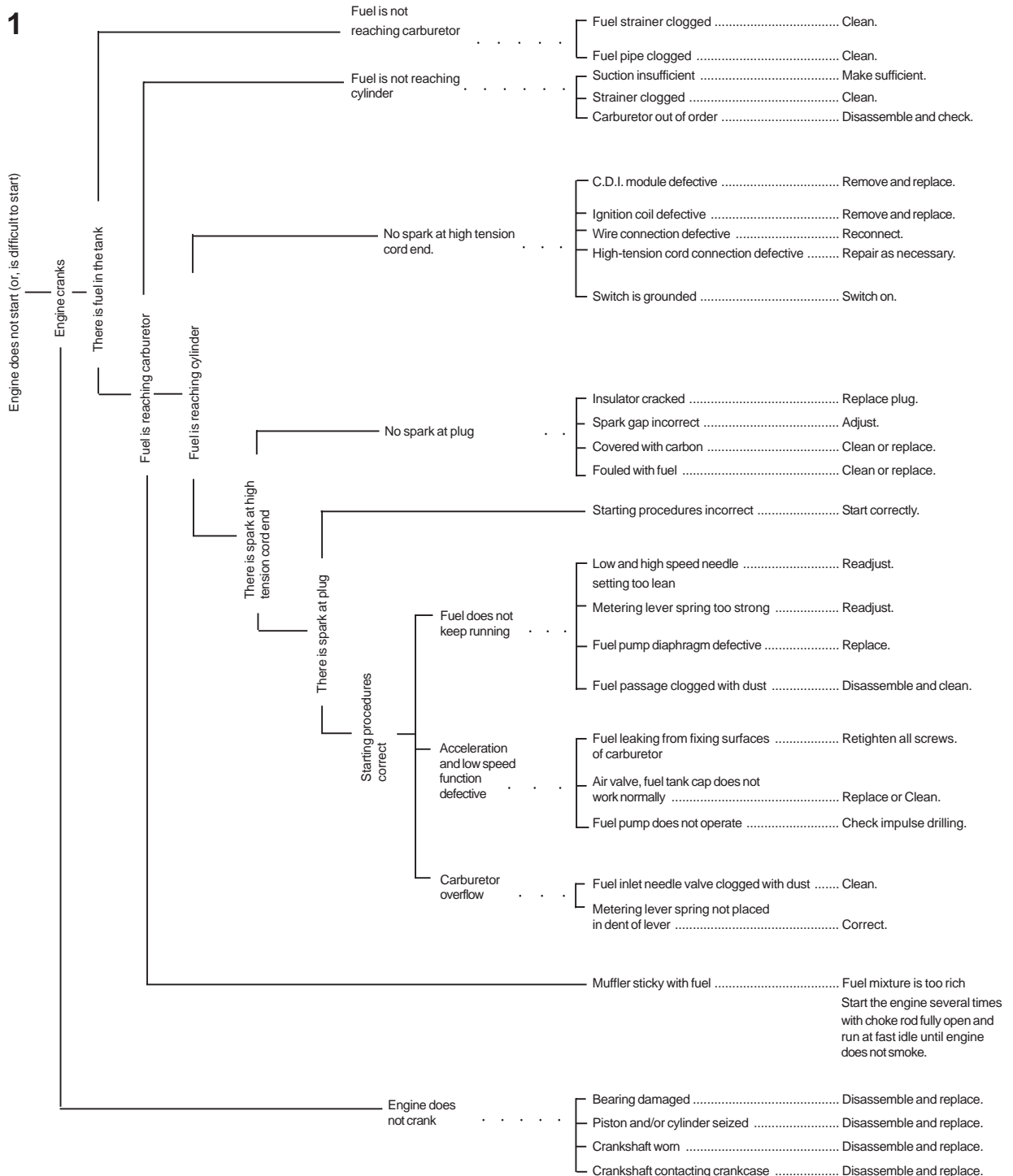
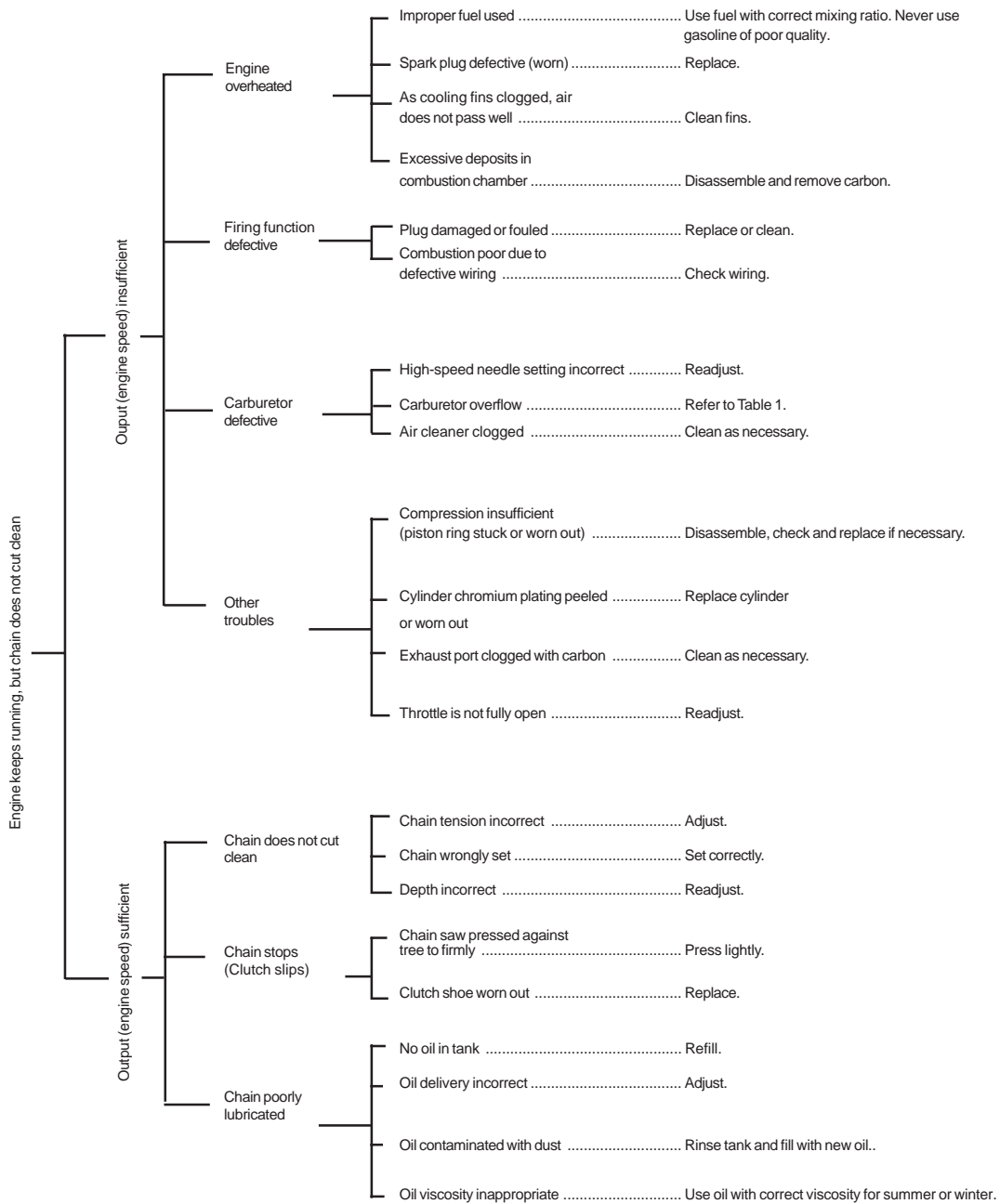

Table 2



WARNING  DANGER

Fuel vapors are extremely flammable and may cause fire and/or explosion. Never test for ignition spark by grounding spark plug near cylinder plug hole, otherwise serious personal injury may result.

STORAGE AFTER USE

- Inspect and adjust every part of the chain saw.
 - Completely clean every part, and repair, if necessary.
 - Apply thin coating of oil on metal parts to prevent corrosion.
- Drain fuel tank, pull starter slowly a few times to drain fuel from carburetor.
- Pour a small amount of clean two-stroke oil into spark plug hole, pull starter 2 to 3 times, then leave the piston at TOP DEAD CENTER.
- Store in a dry area, free from dust.

CORRECT USE OF CHAIN BRAKE

The installation of a chain brake may be mandatory by law or as stipulated by insurance regulations in your area of operation. You should inquire through local government offices, your employer or your local dealer to ensure that your chain saw conforms to the required safety standard. Echo chain brakes have been designed and tested to comply with international safety standards as follows.

USA: ANSI Standard B175.1-2000 Safety Requirement for chain saws

Canada: CSA Standard Z 62.1 CHAIN SAWS

WARNING DANGER

ANSI Standard B175.1-2000 stipulates that the brake shall stop the chain in 0.15 seconds maximum (.12 sec avg) at full throttle. It is the responsibility of the Owner/Operator to ensure that the brake is serviced, adjusted and tested strictly in accordance with the instructions as detailed herein in order to ensure that the brake performance is maintained in compliance with the Standard B175.1-2000.

Kickback Motion:

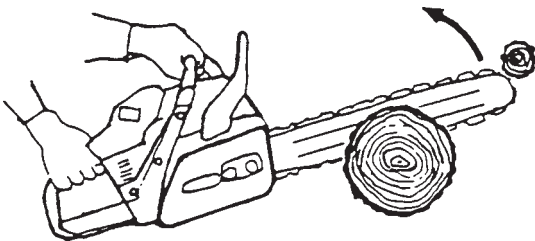

- When the bar nose hits another tree, etc.

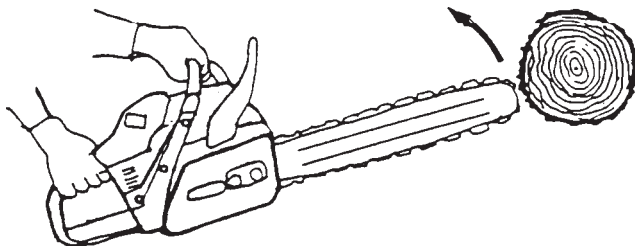

- Improper thrust cutting.

Function:

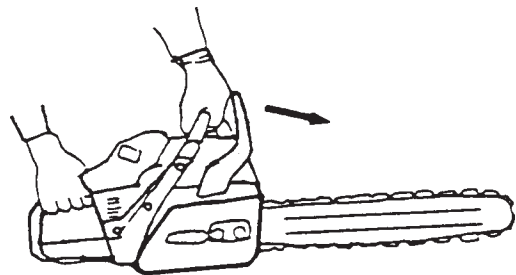

- When the lever is pushed forward, chain brake instantly works to stop the chain.

Release:

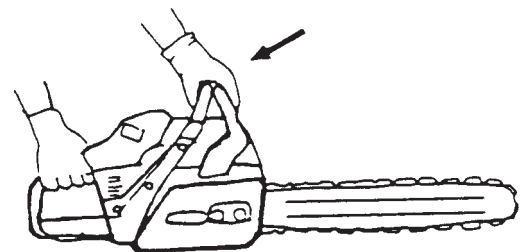

- When the lever is fully pulled toward the operator, brake is released.

INSTALLATION

- Echo recommends that the chain brake should be serviced by an authorized Echo servicing dealer.

OPERATION

- Set the lever in the released position before starting to cut.
- If the brake is tripped by kick back reaction, the chain will stop. Immediately release the throttle to avoid possible damage to the engine or clutch.
- Do not attempt to operate the engine with the brake engaged.

TESTING THE BRAKE

- Start the engine on a solid level surface and run at a fast idle until warm.
- Hold the saw firmly by the handles and accelerate the engine to a fast idle.
- Slowly operate the chain brake lever while holding the saw firmly on the ground. When the brake lever trips, the chain should stop. Immediately release the throttle trigger.

IMPORTANT

Do not allow the saw to tip forward in order to avoid damage to the chain.

If the chain does not stop, immediately return the saw to your authorized Echo dealer for repair.

NOTES

SERVICING INFORMATION

PARTS/SERIAL NUMBER

Genuine ECHO Parts and ECHO REPOWER™ Parts and Assemblies for your ECHO products are available only from an Authorized ECHO Dealer. When you do need to buy parts **always** have the Model Number and Serial Number of the unit with you. You can find these numbers on the engine housing. For future reference, write them in the space provided below.

Model No. _____ SN. _____

SERVICE

Service of this product during the warranty period must be performed by an Authorized ECHO Service Dealer. For the name and address of the Authorized ECHO Service Dealer nearest you, ask your retailer or call: 1-800-432-ECHO. When presenting your unit for Warranty service/repairs, proof of purchase is required.

ECHO CONSUMER PRODUCT SUPPORT

If you require assistance or have questions concerning the application, operation or maintenance of this product you may call the ECHO Consumer Product Support Department at 1-800-673-1558 from 8:30 am to 4:30 pm (Central Standard Time) Monday through Friday. Before calling, please know the model and serial number of your unit to help your Consumer Product Support Representative.

WARRANTY CARD

This card is our means of registering all original owners of ECHO equipment. The card plus proof of purchase provides you the assurance that authorized warranty work will be done. It also provides a direct link between you and ECHO if we find it necessary to contact you.

ADDITIONAL OR REPLACEMENT MANUALS

Safety Manuals in English/Spanish or English/French are available, free of charge, from your ECHO dealer or at www.echo-usa.com.

Instruction and Parts Manuals are available by:

- Downloading free from www.echo-usa.com
- Purchasing from your Echo Dealer.
- Manuals are available by sending a written request stating the model number and serial number of your Echo unit, part number of the manual, your name and address, and mail to the address below.

Safety Videos are available from your Echo dealer. A \$5.00 shipping charge will be required for each video.

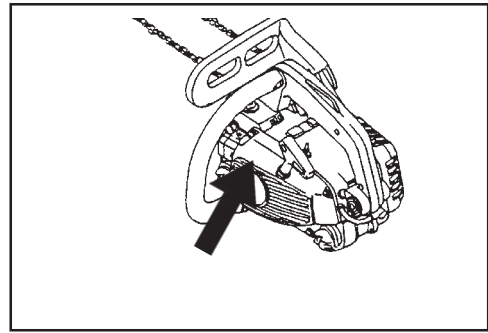

DEALER?

Call
1-800-432-ECHO
or
www.echo-usa.com

CONSUMER PRODUCT SUPPORT

1-800-673-1558
8:30 - 4:30 Mon - Fri C.S.T.

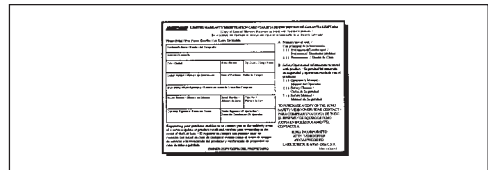

ECHO

ECHO, INCORPORATED

400 OAKWOOD ROAD
LAKE ZURICH, IL 60047-1564

www.echo-usa.com

09001001/09999999

Free Manuals Download Website

<http://myh66.com>

<http://usermanuals.us>

<http://www.somanuals.com>

<http://www.4manuals.cc>

<http://www.manual-lib.com>

<http://www.404manual.com>

<http://www.luxmanual.com>

<http://aubethermostatmanual.com>

Golf course search by state

<http://golfingnear.com>

Email search by domain

<http://emailbydomain.com>

Auto manuals search

<http://auto.somanuals.com>

TV manuals search

<http://tv.somanuals.com>