



Pro Attachment Series™

Operator's Manual

MODEL

PAS-230

WARNING  **DANGER**



The muffler or catalytic muffler and surrounding cover may become extremely hot.

Always keep clear of exhaust and muffler area, otherwise serious personal injury may occur.



WARNING



The engine exhaust from this product contains chemicals known to the State of California to cause cancer, birth defects or other reproductive harm.



WARNING  **DANGER**

Read rules for safe operation and instructions carefully. ECHO provides an Operator's Manual with this unit and a separate Operator's Manual and Safety Manual (if available) with the attachment. All manuals must be read and understood for proper and safe operation. Failure to do so could result in serious injury.

X7532096801

X753002311
12/05

INTRODUCTION

Welcome to the ECHO family. This ECHO product was designed and manufactured to provide long life and on-the-job-dependability. Read and understand this manual as well as your attachment operator's manual and SAFETY MANUAL (if available) before operation. You will find these manuals easy to read and full of helpful operating tips and SAFETY messages.

THE OPERATOR'S MANUAL

Read and understand this manual before operation. Keep it in a safe place for future reference. It contains specifications and information for operation, starting, stopping, maintenance, storage and assembly specific to this product.

THE ATTACHMENT OPERATOR'S MANUAL

Read and understand this manual before operation. Keep it in a safe place for future reference. It contains specifications and information for operation and maintenance specific to the attachment.

THE SAFETY MANUAL

(If available for attachment)

Explains possible hazards and what measures you should take to insure safe operation.

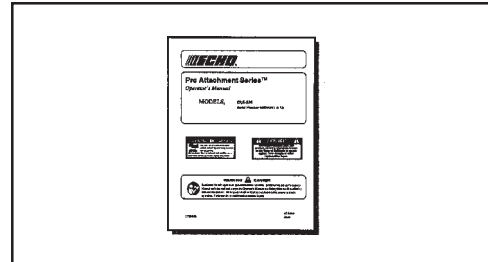

TABLE OF CONTENTS

Introduction	2	Maintenance	14
- The Operator's Manual	2	- Skill Levels	14
- The Attachment Operator's Manual	2	- Maintenance Intervals	14
- The Safety Manual		- Air Filter	15
Safety	3	- Fuel Filter	15
Manual Safety Symbols and Important Information	3	- Spark Plug	16
- International Symbols	3	- Cooling System Cleaning	16
- Personal Condition and Safety Equipment	3	- Exhaust System	17
- Equipment	6	- Carburetor Adjustment	18
Emission Control	6	- Lubrication	19
Description	7	Troubleshooting	20
Contents	9	Storage	21
Assembly	9	Specifications	22
- Attachment Shaft Assembly	9	- ECHO Approved Optional Attachments	22
- Front Handle Adjustment/Barrier Bar Assembly ..	10	- Recommended Optional Attachments	22
Operation	11	Servicing Information	24
- Fuel	11	- Parts/Serial Number	24
- Starting Cold Engine	12	- Service	24
- Starting Warm Engine	13	- ECHO Consumer Product Support	24
- Stopping Engine	13	- Warranty Card	24
		- Additional or Replacement Manuals	24

Specifications, descriptions and illustrative material in this literature are as accurate as known at the time of publication, but are subject to change without notice. Illustrations may include optional equipment and accessories, and may not include all standard equipment.

SAFETY MANUAL SAFETY SYMBOLS AND IMPORTANT INFORMATION

Throughout this manual and on the product itself, you will find safety alerts and helpful, information messages preceded by symbols or key words. The following is an explanation of those symbols and key words and what they mean to you.



This symbol accompanied by the words **WARNING** and **DANGER** calls attention to an act or condition that can lead to serious personal injury to operator and bystanders.



The circle with the slash symbol means whatever is shown within the circle is prohibited.



IMPORTANT

The enclosed message provides information necessary for the protection of the unit.

NOTE

This enclosed message provides tips for use, care and maintenance of the unit.

INTERNATIONAL SYMBOLS

Symbol form/shape	Symbol description/application	Symbol form/shape	Symbol description/application
	Read and understand Operator's Manual.		Fuel and oil mixture
	Wear eyes, ears and head protection		Finger Severing
	Hot Surface		Wear hand protection. Use two handed.
	Safety/Alert		DO NOT smoke near fuel.
	Avoid all power lines. This unit is not insulated against electrical current.		Do not operate closer than 15 m (50 ft.) from electrical hazards.
	Keep bystanders at least 15 m (50 ft.) away.		Plan retreat path from falling objects.

Symbol form/shape	Symbol description/application	Symbol form/shape	Symbol description/application
	DO NOT allow flames or sparks near fuel.		Wear slip resistant foot wear.
	Emergency stop		Ignition ON/OFF
	Choke Control "Cold Start" Position (Choke Closed)		Primer bulb
	Choke Control "Run" Position (Choke Open)		Carburetor adjustment - High speed mixture
	Carburetor adjustment - Low speed mixture		Carburetor adjustment - Idle speed

PERSONAL CONDITION AND SAFETY EQUIPMENT

WARNING DANGER

Pro Attachment Series™ users risk injury to themselves and others if the Pro Attachment Series™ unit is used improperly and or safety precautions are not followed. Proper clothing and safety gear must be worn when operating a Pro Attachment Series™ unit.

Physical Condition

Your judgment and physical dexterity may not be good:

- if you are tired or sick,
- if you are taking medication,
- if you have taken alcohol or drugs.

Operate unit only if you are physically and mentally well.

Eye Protection

Wear eye protection that meets ANSI Z87.1 or CE requirements whenever you operate the unit.

Hand Protection

Wear no-slip, heavy-duty work gloves to improve your grip on the handles. Gloves also reduce the transmission of machine vibration to your hands.

Hearing Protection

ECHO recommends wearing hearing protection whenever unit is used.

Proper Clothing

Wear snug fitting, durable clothing;

- Pants should have long legs, shirts with long sleeves.
- DONOTWEARSHORTS,
- DONOTWEARTIES,SCARFS,JEWELRY.

Wear protective hair covering to contain long hair.

Wear sturdy work shoes with nonskid soles;

- DONOTWEAROPENTOEDSHOES,
- DONOTOPERATEUNITBAREFOOTED.

Hot Humid Weather

Heavy protective clothing can increase operator fatigue which may lead to heat stroke. Schedule heavy work for early morning or late afternoon hours when temperatures are cooler.

Vibration and Cold

It is believed that a condition called Raynaud's Phenomenon, which affects the fingers of certain individuals, may be brought about by exposure to vibration and cold. Exposure to vibration and cold may cause tingling and burning sensations, followed by loss of color and numbness in the fingers. The following precautions are strongly recommended, because the minimum exposure which might trigger the ailment is unknown.

- Keep your body warm, especially the head, neck, feet, ankles, hands, and wrists.
- Maintain good blood circulation by performing vigorous arm exercises during frequent work breaks, and also by not smoking.
- Limit the hours of operation. Try to fill each day with jobs where operating the trimmer or other hand-held power equipment is not required.
- If you experience discomfort, redness and swelling of the fingers followed by whitening and loss of feeling, consult your physician before further exposing yourself to cold and vibration.



Repetitive Stress Injuries

It is believed that overusing the muscles and tendons of the fingers, hands, arms, and shoulders may cause soreness, swelling, numbness, weakness, and extreme pain in those areas. Certain repetitive hand activities may put you at a high risk for developing a Repetitive Stress Injury (RSI). An extreme RSI condition is Carpal Tunnel Syndrome (CTS), which could occur when your wrist swells and squeezes a vital nerve that runs through the area. Some believe that prolonged exposure to vibration may contribute to CTS. CTS can cause severe pain for months or even years.

To reduce the risk of RSI/CTS, do the following:

- Avoid using your wrist in a bent, extended or twisted position. Instead try to maintain a straight wrist position. Also, when grasping, use your whole hand, not just the thumb and index finger.
- Take periodic breaks to minimize repetition and rest your hands.
- Reduce the speed and force with which you do the repetitive movement.
- Do exercises to strengthen the hand and arm muscles.
- Immediately stop using all power equipment, and consult a doctor if you feel tingling, numbness or pain in the fingers, hands, wrists or arms. The sooner RSI/CTS is diagnosed, the more likely permanent nerve and muscle damage can be prevented.

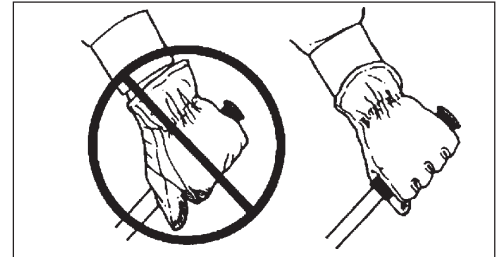

WARNING DANGER

Do not operate this product indoors or in inadequately ventilated areas. Engine exhaust contains poisonous emissions and can cause serious injury or death.

Read the Manuals

- Provide all users of this equipment with the Operator's Manual and Safety Manual for instructions on Safe Operation.

Clear the Work Area

- Spectators and fellow workers must be warned, and children and animals prevented from coming nearer than 15 m (50 ft.) while the unit is in use.

Keep a Firm Grip

- Hold the front and rear handles with both hands, with thumbs and fingers encircling the handles.

Keep a Solid Stance

- Maintain footing and balance at all times. Do not stand on slippery, uneven or unstable surfaces. Do not work in odd positions or on ladders. Do not over reach.

Avoid Hot Surfaces

- Keep exhaust area clear of flammable debris. Avoid contact during and immediately after operation.

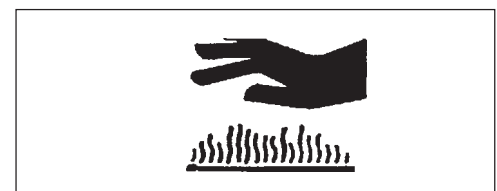

EQUIPMENT

WARNING DANGER

Use only ECHO approved attachments for Pro Attachment Series™ models. Serious injury may result from the use of a non-approved attachment combination. Read and comply with all safety instructions listed in this manual and attachment manual.

NOTE

ECHO, INC. will not be responsible for the failure of cutting devices, attachments, or accessories which have not been tested and approved by ECHO for use with this Pro Attachment Series™.

- Check unit for loose/missing nuts, bolts and screws. Tighten and/or replace as needed.
- Inspect fuel lines, tank and area around carburetor for fuel leaks. DO NOT operate unit if leaks are found.
- Inspect guards for damage and ensure that they are securely in place. Replace if guard is damaged or missing.
- Check that the attachment is firmly attached and in safe operating condition.

EMISSION CONTROL

EPA Phase 2

The emission control system for these engines are EM/TWC (Engine Modification and Catalyst).

IMPORTANT ENGINE INFORMATION

ENGINE FAMILY: 5EHXS.0234KA DISPLACEMENT: 22.8 cc
EMISSION COMPLIANCE PERIOD: 300 Hours
THIS ENGINE MEETS U.S. EPA PH2 AND 2005 - 2006
CALIFORNIA EMISSION REGULATIONS FOR SORES. REFER
TO OWNER'S MANUAL FOR MAINTENANCE SPECIFICATIONS
AND ADJUSTMENTS.

An Emission Control Label is located on the engine. (This is an EXAMPLE ONLY, information on label varies by engine



KIORITZ CORP. 

FAMILY).

PRODUCT EMISSION DURABILITY

The 300 hour emission durability compliance period is the time span selected by the manufacturer certifying the engine emissions output meets applicable emissions regulations, provided that approved maintenance procedures are followed as listed in the Maintenance Section of this manual.

DESCRIPTION

Locate these safety decals on your unit. Make sure the decals are legible and that you understand and follow the instructions on them. If a decal cannot be read, a new one can be ordered from your ECHO dealer. See PARTS ORDERING instructions for specific information.

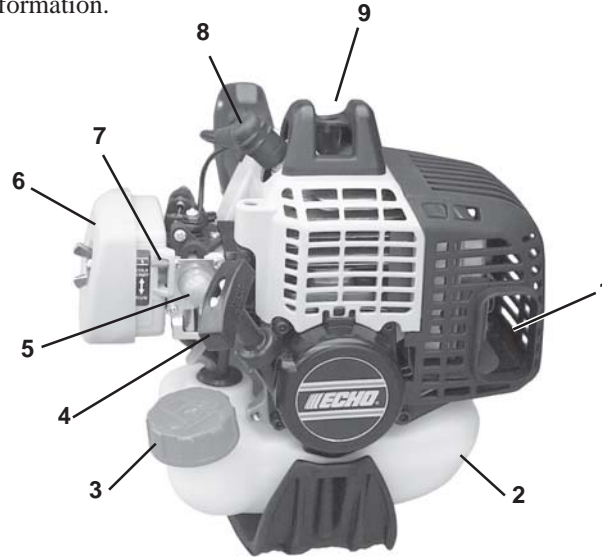

Hot Decal (near muffler)
P/N 89016006361

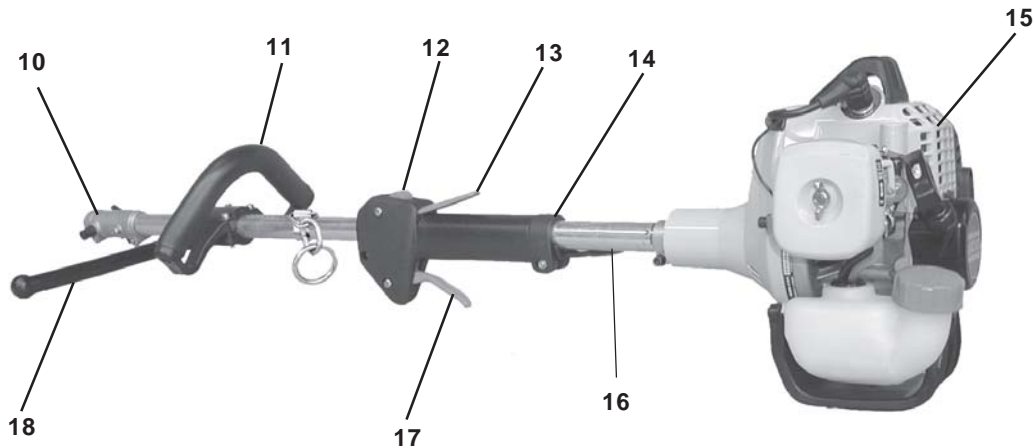

Shaft Decal
Spanish Decal

P/N 89022809560

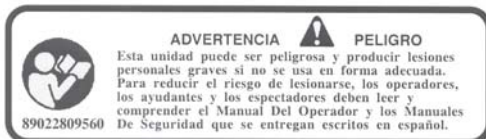

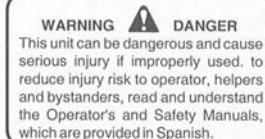

English Translation



P/N X505001930



1. **MUFFLER, SPARK ARRESTOR** - The muffler controls the exhaust noise while the spark arrestor prevents hot, glowing particles of carbon from leaving the muffler where they could possibly start a fire.
2. **FUEL TANK** - Contains fuel and fuel filter.
3. **FUEL TANK CAP** - Covers and seals fuel tank opening.
4. **RECOIL STARTER HANDLE** - Pull handle slowly until recoil starter engages, then quickly and firmly. When engine starts, return handle slowly. **DO NOT** let handle snap back or damage to unit will occur.
5. **PURGE BULB** - Pumping purge bulb before starting engine draws fresh fuel from the fuel tank, purging air from the carburetor. Pump purge bulb until fuel is visible and flows freely in the clear fuel tank return line. Pump purge bulb an additional 4 or 5 times.
6. **AIR CLEANER** - Contains replaceable filter element.
7. **CHOKE** - The choke control lever is located on the top of the air cleaner case. Move choke lever to **COLD START**  position to close choke for cold starting. Move choke lever to the **RUN**  position to open choke.
8. **SPARK PLUG** - Provides spark to ignite fuel mixture.
9. **TOP GUARD** - Protects arm from the hot engine.
10. **DRIVE SHAFT COUPLER** - Includes Locator Pin and Clamping Knob.
11. **FRONT HANDLE** - The Front Handle is assembled to the Upper Drive Shaft assembly and must be positioned for proper cutting attitude and operator comfort.
12. **STOP SWITCH** - "SLIDE SWITCH" mounted on top of the Throttle Trigger Housing. Move switch **FORWARD** to **RUN**, **BACK** to **STOP**.
13. **THROTTLE TRIGGER LOCKOUT** - This lever must be held during starting. Operation of the throttle trigger is prevented unless throttle trigger lockout lever is engaged.
14. **GRIP** - Rear (right hand) handle.
15. **POWER HEAD** - Includes the Engine, Clutch, Fuel System, Ignition System and Recoil Starter.
16. **UPPER DRIVE SHAFT ASSEMBLY** - Includes the Rear (Right Hand) Handle Assembly, Front (Left Hand) Handle Assembly, Flexible Drive Cable, Drive Shaft Assembly Coupler, Harness Ring, and Power Head.
17. **THROTTLE TRIGGER** - Spring loaded to return to idle when released. During acceleration, press trigger gradually for best operating technique.
18. **BARRIER BAR** - Helps keep the cutting attachment away from the operator's legs and feet by limiting rearward movement of the unit if kick out occurs. Not for use as a handle. May be used with all Echo-approved attachments unless instructed otherwise in the attachment Operator's Manual.

CONTENTS

The ECHO product you purchased has been factory pre-assembled for your convenience. Due to packaging restrictions, other assembly may be necessary.

After opening the carton, check for damage. Immediately notify your retailer or ECHO Dealer of damaged or missing parts. Use the contents list to check for missing parts.

- 1 - Power Head w / Upper Drive Shaft Assembly
- 1 - Plastic Bag (co-pack)
 - 1, Barrier Bar
 - 1, Operator's Manual
 - 1, Warranty Registration Card
 - 1, ECHO Emissions and Warranty Statement
 - 1, Safety Glasses
 - 1, Echo Power Blend™ 2-stroke oil sample

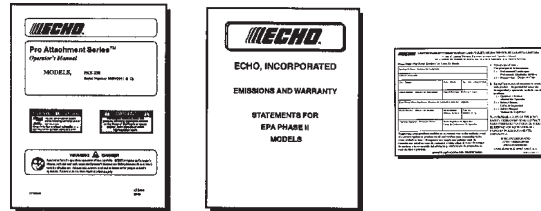

ASSEMBLY

ATTACHMENT SHAFT ASSEMBLY

Tools Required: None

Parts Required: PAS Attachment Assembly

1. Set Power Head/Shaft Assembly on a level surface.
2. Pull locator pin (A) out, and turn counter-clockwise 1/4 turn to lock-out position.
3. Remove vinyl cap from attachment drive shaft.
4. Remove cardboard spacer, if necessary.
5. Carefully fit attachment drive shaft assembly into coupler (B) making sure that the inner lower drive shaft engages into the square upper drive shaft socket.
6. Rotate locator pin (A) 1/4 turn clockwise to engage lower shaft hole. Insure locator pin is fully engaged by twisting lower drive shaft. Locator pin should snap flush in coupler. Full engagement will prevent further shaft rotation.
7. Secure lower shaft assembly to coupler by tightening clamping knob (C).

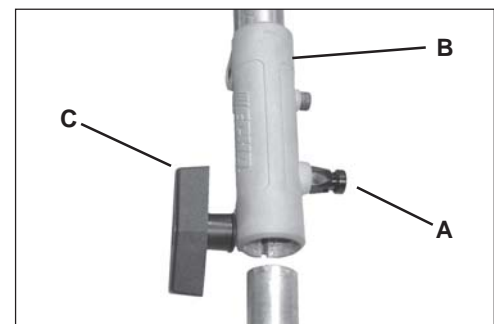
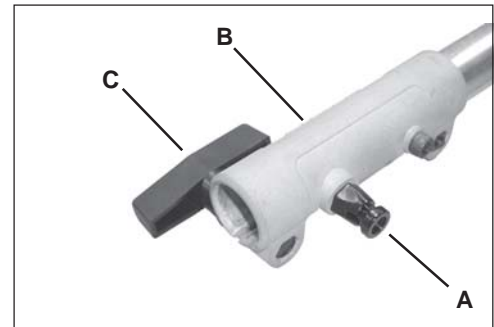

FRONT HANDLE ADJUSTMENT/BARRIER BAR ASSEMBLY

Tools Required: Screwdriver.

Parts Required: Barrier Bar

Handle Adjustment

NOTE

Label shows minimum spacing for front handle location.

1. Stand in a comfortable operating position with attachment assembled, and position front handle for comfortable operation. Tighten handle screws.

Barrier Bar Assembly

NOTE

The barrier bar may be used with all attachments unless instructed otherwise in the attachment Operator's Manual.

1. Unscrew bottom bracket of handle, and replace with Barrier Bar as shown. Adjust handle and secure as described above.



OPERATION

NOTICE: Use of unmixed, improperly mixed, or fuel older than 90 days, (stale fuel), may cause hard starting, poor performance, or severe engine damage and void the product warranty. Read and follow instructions in the Storage section of this manual.

FUEL

Fuel Requirements

Gasoline - Use 89 Octane [R+M/2] (mid grade or higher) gasoline known to be good quality. Gasoline may contain up to 15% MTBE (methyl tertiary-butyl ether). Gasohol containing methyl (wood) alcohol is **NOT** approved.

Two Stroke Oil - A two-stroke engine oil meeting ISO-L-EGD (ISO/CD 13738) and J.A.S.O. FC Standards must be used. Echo brand premium Power Blend™ Universal 2-Stroke Oil meets these standards. Engine problems due to inadequate lubrication caused by failure to use an ISO-L-EGD and J.A.S.O. FC certified oil, such as Echo premium Power Blend™, will void the two-stroke engine warranty. (Emission related parts only are covered for two years, regardless of two-stroke oil used, per the statement listed in the Emission Defect Warranty Explanation.)

IMPORTANT

Echo premium Power Blend™ Universal 2-Stroke Oil may be mixed at 50:1 ratio for application in all Echo engines sold in the past regardless of ratio specified in those manuals.

Handling Fuel

WARNING DANGER

Fuel is VERY flammable. Use extreme care when mixing, storing or handling or serious personal injury may result.

- Use an approved fuel container.
- DO NOT smoke near fuel.
- DO NOT allow flames or sparks near fuel.
- Fuel tanks/cans may be under pressure. Always loosen fuel caps slowly allowing pressure to equalize.
- NEVER refuel a unit when the engine is HOT or RUNNING!
- DO NOT fill fuel tanks indoors. ALWAYS fill fuel tanks outdoors over bare ground.
- DO NOT overfill fuel tank. Wipe up spills immediately.
- Securely tighten fuel tank cap and close fuel container after refueling.
- Inspect for fuel leakage. If fuel leakage is found, do not start or operate unit until leakage is repaired.
- Move at least 3m (10 ft.) from refueling location before starting the engine.

Fuel to Oil Mix - 50:1 Ratio

U.S.		METRIC	
GAS	OIL	GAS	OIL
Gallons	Fl. oz.	Liter	cc.
1	2.6	4	80
2	5.2	8	160
5	13	20	400

Mixing Instructions

1. Fill an approved fuel container with half of the required amount of gasoline.
2. Add the proper amount of 2-stroke oil to gasoline.
3. Close container and shake to mix oil with gasoline.
4. Add remaining gasoline, close fuel container, and remix.

IMPORTANT

Spilled fuel is a leading cause of hydrocarbon emissions. Some states may require the use of automatic fuel shut-off containers to reduce fuel spillage.

After use

- DO NOT store a unit with fuel in its tank. Leaks can occur. Return unused fuel to an approved fuel storage container.

Storage - Fuel storage laws vary by locality. Contact your local government for the laws affecting your area. As a precaution, store fuel in an approved, airtight container. Store in a well-ventilated, unoccupied building, away from sparks and flames.

IMPORTANT

Stored fuel ages. Do not mix more fuel than you expect to use in thirty (30) days, ninety (90) days when a fuel stabilizer is added.

IMPORTANT

Stored two-stroke fuel may separate. ALWAYS shake fuel container thoroughly before each use.

STARTING COLD ENGINE

WARNING DANGER

The attachment will operate immediately when the engine starts and could result in loss of control and possible serious injury. Keep movable parts of the attachment off the ground and away from objects that could become entangled or thrown.

1. *Stop Switch*

Move stop switch button (A) forward, away from the STOP position.

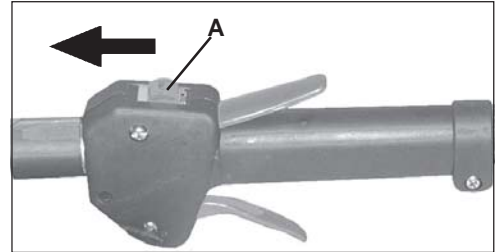

2. *Choke Lever*

Move choke lever (B) to Cold Start () Position.

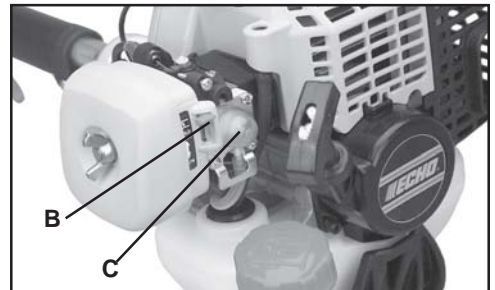

3. *Purge Bulb*

Pump purge bulb (C) until fuel is visible and flows freely in the clear fuel tank return line. Pump bulb an additional 4 or 5 times.

4. *Recoil Starter*

Lay the unit on a flat area and keep movable attachment parts clear of all obstacles. Firmly grasp right hand grip and throttle trigger lockout with left hand and fully depress throttle trigger to wide open position. Rapidly pull recoil starter handle/rope (D) until engine fires (or maximum five [5] pulls).

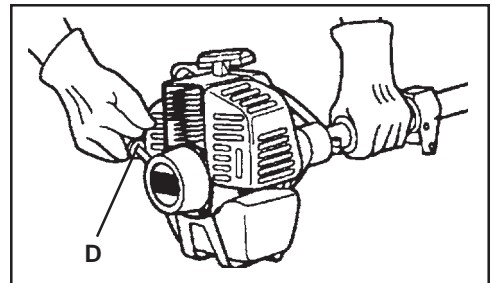

5. *Choke*

After engine fires (or 5 pulls), move choke lever back to Run () position. Hold throttle trigger and throttle trigger lockout fully depressed, and pull recoil starter handle/rope until engine starts and runs. Release throttle trigger, and allow unit to warm up at idle for several minutes.

NOTE

If engine does not start with choke in "Run" position after 5 pulls, repeat instructions 2 - 5.

6. *Throttle Trigger*

After engine warm-up, gradually depress throttle trigger to increase engine RPM to operating speed.

STARTING WARM ENGINE

The starting procedure is the same as Cold Start except DO NOT close the choke, and do not depress throttle trigger to wide open position.

WARNING DANGER

The attachment should not move at idle, otherwise serious personal injury may result.

NOTE

If attachment moves, readjust carburetor according to "Carburetor Adjustment" instructions in this manual or see your ECHO Dealer.

1. *Stop Switch*
Move stop switch button/lever (A) away from the STOP position.
2. *Purge Bulb*
Pump purge bulb (C) until fuel is visible and flows freely in the clear fuel tank return line. Pump bulb an additional 4 or 5 times.
3. *Recoil Starter*
Lay the unit on a flat area and keep movable attachment parts clear of all obstacles. Rapidly pull recoil starter handle/rope (D) until engine fires.

NOTE

If engine does not start after 5 pulls, use Cold Start Procedure.

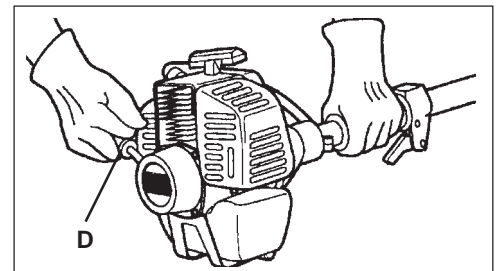
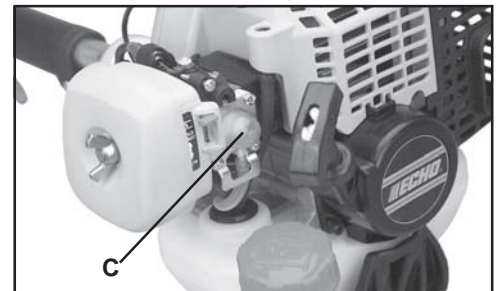
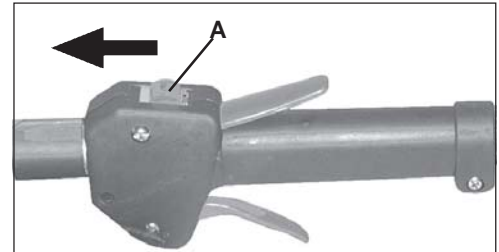

STOPPING ENGINE

1. *Throttle*
Release throttle and allow engine to return to idle before shutting off engine.
2. *Stop Switch*
Move stop switch button/lever (A) to STOP position.

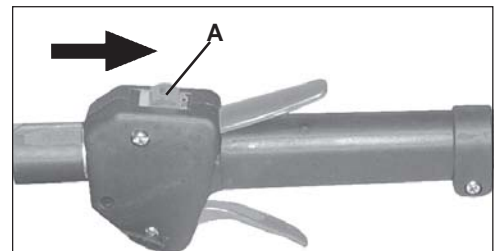

WARNING DANGER

If engine does not stop when stop switch is moved to STOP position, close choke - COLD START position - to stall engine. Have your ECHO dealer repair stop switch before using unit again.

MAINTENANCE

Your ECHO unit is designed to provide many hours of trouble-free service. Regular scheduled maintenance will help your unit achieve that goal. If you are unsure or are not equipped with the necessary tools, you may want to take your unit to an ECHO Service Dealer for maintenance. To help you decide whether you want to DO-IT-YOURSELF or have the ECHO Dealer do it, each maintenance task has been graded. If a task is not listed, see your ECHO Dealer for repairs.

SKILL LEVELS

- Level 1** = Easy to do. Most required tools come with unit.
- Level 2** = Moderate difficulty. Some specialized tools may be required.
- Level 3** = Experience required. Specialized tools are required. ECHO recommends that the unit be returned to your ECHO dealer for service.

ECHO offers **REPOWER™** Maintenance Kits and Parts to make your maintenance job easier. Below each task heading are listed the various part numbers required for that task. See your ECHO dealer for these parts.

MAINTENANCE INTERVALS

COMPONENT/ SYSTEM	MAINTENANCE PROCEDURE	REQ'D SKILL LEVEL	DAILY OR BEFORE USE	EVERY REFUEL	3 MONTHS OR 90 HOURS	6 MONTHS OR 270 HOURS	YEARLY 600 HOURS
Recommended Echo Dealer Maintenance Procedures							
Cylinder Exhaust Port	Inspect/Clean/Decarbon	3			I / C		
Do-It-Yourself Maintenance Procedures							
Air Filter	Inspect/Clean/Replace	1	I / C		R*		
Choke	Inspect/Clean	2	I / C				
Fuel Filter	Inspect/Replace	1			I		I / R *
Fuel System, leaks	Inspect/Replace	1	I *	I	I		
Cooling System	Inspect/Clean	2	I / C				
Muffler Spark Arrestor	Inspect/Replace	2			I / R *		
Drive Shaft	Grease	2			I (I)		
Recoil Starter Rope	Inspect/Clean	1	I / C *				
Spark Plug	Inspect/Clean	2			I / C	R *	
Screws/Nuts/Bolts	Inspect/Tighten/Replace	1	I / R *				

MAINTENANCE PROCEDURE LETTER CODES: I = INSPECT, R = REPLACE, C = CLEAN

IMPORTANT NOTE - Time intervals shown are maximum. Actual use and your experience will determine the frequency of required maintenance.

MAINTENANCE PROCEDURE NOTES:

(1) Apply ECHO® LUBE™ every 25 hours of use.

* All recommendations to replace are based on the finding of damage or wear during inspection..

AIR FILTER

Level 1.

Tools required: 25 or 50 mm (1 or 2 in.) medium bristle cleaning brush

Parts required: 90008 REPOWER™ Air and Fuel Filter Kit

1. Close choke (Cold Start Position ). This prevents dirt from entering the carburetor throat when the air filter is removed. Brush accumulated dirt from the air filter area.
2. Remove the air filter cover. Lightly brush debris from filter. If filter is fuel soaked, deformed, or very dirty, replace it.
3. If filter can be reused, be certain it:
 - fits tightly in the air filter cavity.
 - is installed with the original side out.



FUEL FILTER

Level 1.

Tools required: 200-250 mm (8-10 in.) length of wire with one end bent into a hook, Clean rag, funnel, an approved fuel container,

Parts required: 90008 REPOWER™ Air and Fuel Filter Kit

WARNING  **DANGER**
Fuel is **VERY** flammable. Use extreme care when mixing, storing or handling, otherwise serious personal injury may result.

1. Use a clean rag to remove loose dirt from around fuel cap and empty fuel tank.
2. Use the “fuel line hook” to pull the fuel line and filter from the tank.
3. Remove the filter from the line and install the new filter.



SPARK PLUG

Level 2.

Tools required: T-Wrench, Feeler gauge, Soft metal brush.

Parts Required: REPOWER™ Tune-Up Kit P/N 90074

IMPORTANT

Use only NGK BPM-8Y spark plug (BPMR-8Y in Canada) otherwise severe engine damage may occur.

1. Remove spark plug and check for fouling, worn and rounded center electrode.
2. Clean the plug or replace with a new one. DO NOT sand blast to clean. Remaining sand will damage engine.
3. Adjust spark plug gap by bending outer electrode.
4. Tighten spark plug to 150-170 kg/cm (130-150 in. lb.).

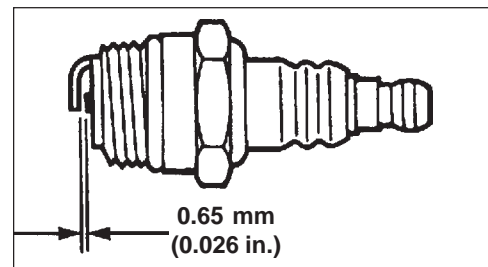
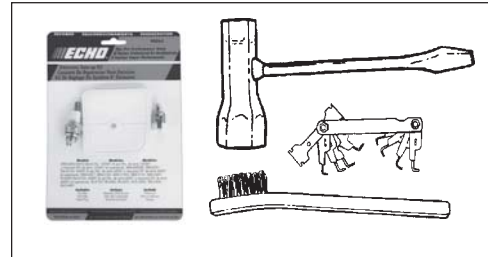

COOLING SYSTEM

Level 2.

Tools required: 25 or 50 mm (1 or 2 in.) medium bristle cleaning brush, Cross-Head Screwdriver, 4 mm Hex Wrench

Parts Required: None if you are careful.

IMPORTANT

To maintain proper engine operating temperatures, cooling air must pass freely through the cylinder fin area. This flow of air carries combustion heat away from the engine.

Overheating and engine seizure can occur when:

- Air intakes are blocked, preventing cooling air from reaching the cylinder.
- Dust and grass build up on the outside of the cylinder. This build up insulates the engine and prevents the heat from leaving.

Removal of cooling passage blockages or cleaning of cooling fins is considered "Normal Maintenance". Any failure attributed to lack of maintenance is not warranted.

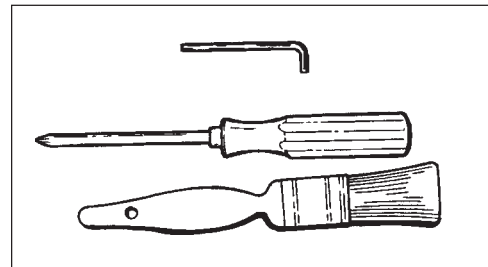

1. Remove spark plug lead.
2. Remove two (2) muffler cover screws and muffler cover (A).
3. Remove screw and arm rest (B).
4. Remove engine cover (C).

IMPORTANT

DO NOT use a metal scraper to remove dirt from the cylinder fins.

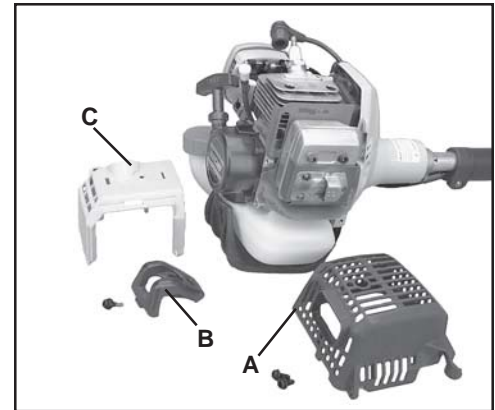

5. Use brush to remove dirt from the cylinder fins.
6. Remove grass and leaves from the grid between the recoil starter and fuel tank.
7. Assemble components in reverse order.

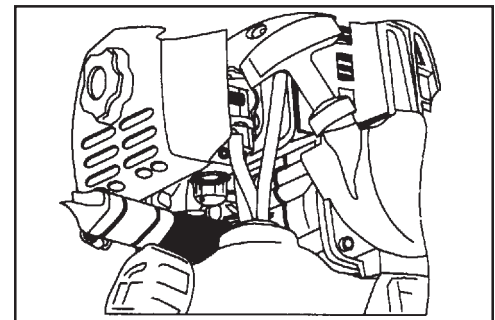

EXHAUST SYSTEM

Spark Arrestor Screen

Level 2.

Tools required: Cross-Head Screwdriver, Soft metal brush, 4 mm Hex Wrench.

Parts Required: Screen, Gasket

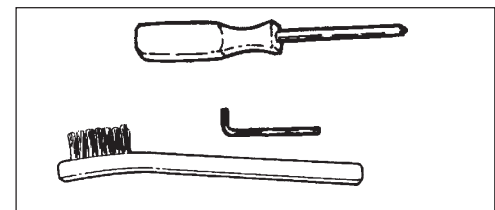

1. Remove muffler cover.
2. Place piston at Top Dead Center (TDC) to prevent carbon/dirt from entering cylinder.
3. Remove spark arrestor screen cover (A), muffler gasket (B), and screen (C) from muffler body.
4. Clean carbon deposits from muffler components.

NOTE

When cleaning carbon deposits, be careful not to damage the catalytic element inside muffler.

5. Replace screen if it is cracked, plugged or has holes burned through.
6. Assemble components in reverse order.

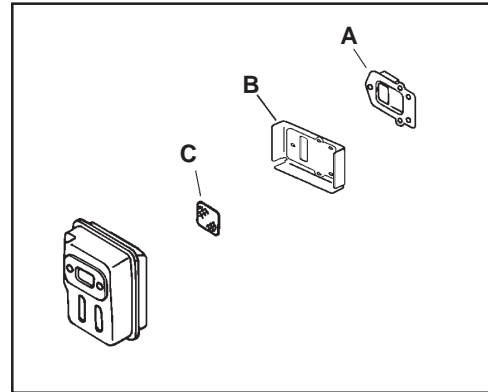

Cylinder Exhaust Port

Level 3.

IMPORTANT

The cylinder exhaust port must be inspected and cleaned of excess carbon every 3 months or 90 hours of operation in order to maintain this engine within the emissions durability period. ECHO strongly recommends that you return your unit to your ECHO dealer for this important maintenance service.

CARBURETOR ADJUSTMENT

Engine Break-In

New engines must be operated a minimum duration of two tanks of fuel break-in before carburetor adjustments can be made. During the break-in period your engine performance will increase and exhaust emissions will stabilize. Idle speed can be adjusted as required.

High Altitude Adjustment

High altitude adjustment is not required for proper operation of this engine.

Level 2.

Tools required: Screwdriver, Tachometer (ECHO/P/N99051130017).

Parts required: None.

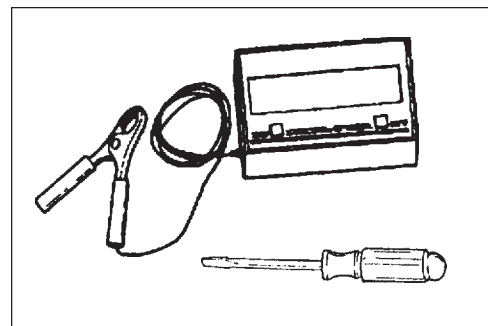

NOTE

Every unit is run at the factory and the carburetor is set in compliance with emission regulations. This carburetor does not have acceleration and high speed adjustment needles.

1. Check idle speed and reset if necessary. If a tachometer is available, idle speed screw (A) should be set to the specifications found on page 22 "Specifications" of this manual. Turn idle screw (A) clockwise to increase idle speed; counter clockwise to decrease idle speed.

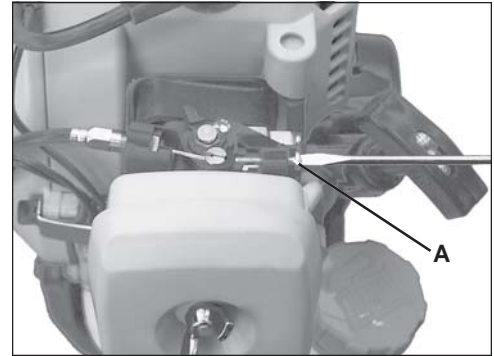

WARNING  **DANGER**

When carburetor adjustment is completed, the attachment should not rotate at idle, otherwise serious personal injury may result.

LUBRICATION

Level 1.

Tools required: 5 mm Hex Wrench, Clean Rag

Parts Required: ECHO[®] LUBE™ 8 oz. (P/N 91014) or Lithium Base Grease.



Drive Shaft Upper

IMPORTANT

The drive shaft must be lubricated with high temperature automotive grease every 25 hours of operation, otherwise drive shaft assembly overheating and failure can result.

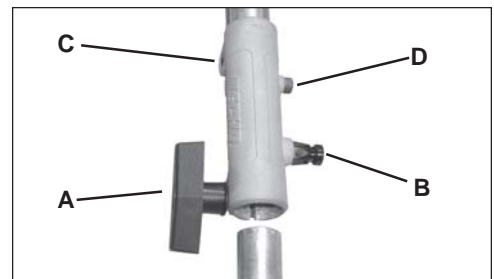

1. Loosen clamping knob (A).
2. Pull locator pin (B) and rotate 1/4 turn counter clockwise to lockout position.
3. Remove attachment.
4. Remove coupler (E) from upper drive shaft assembly by loosening clamping screw (C) and removing set screw (D).
5. Remove upper flex cable (F), wipe clean, and apply a thin coating of 1/2 oz. (15ml) of grease.
6. Install cable. Make sure that the flex cable fully engages into the clutch square drive socket.
7. Slide coupler on upper drive shaft until fully seated, and align set screw hole in coupling with hole in upper drive shaft.
8. Install and tighten set screw (D), and tighten clamping screw (C).

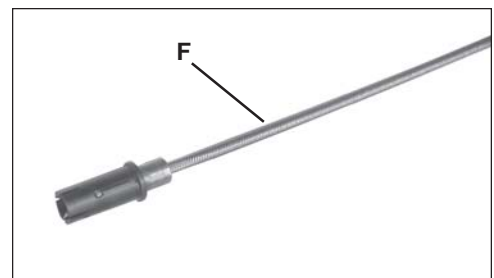
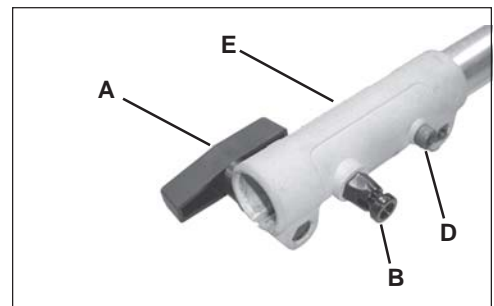

TROUBLESHOOTING

ENGINE PROBLEM TROUBLESHOOTING CHART

Problem	Check	Status	Cause	Remedy
Engine cranks - starts hard/ doesn't start	Fuel at carburetor	No fuel at carburetor	Fuel strainer clogged Fuel line clogged Carburetor	Clean or replace Clean or replace See your Echo dealer
	Fuel at cylinder	No fuel at cylinder	Carburetor	See your Echo dealer
		Muffler wet with fuel	Fuel Mixture too rich	Open choke Clean/replace air filter Adjust carburetor See your Echo dealer
	Spark at end of plug wire	No spark	Stop switch off Electrical problem Interlock switch	Turn switch to ON See your Echo dealer See your Echo dealer
	Spark at plug	No spark	Spark gap incorrect Covered with carbon Fouled with fuel Plug defective	Adjust to .65mm (0.026 in.) Clean or replace Clean or replace Replace plug
Engine runs, but dies or does not accelerate properly	Air filter	Air filter dirty	Normal wear	Clean or replace
	Fuel filter	Fuel filter dirty	Contaminants/residues in fuel	Replace
	Fuel vent	Fuel vent plugged	Contaminants/residues in fuel	Clean or replace
	Spark Plug	Plug dirty/worn	Normal wear	Clean and adjust or replace
	Carburetor	Improper adjustment	Vibration	Adjust
	Cooling System	Excessive dirt/debris	Extended operation in dirty/dusty locations	Clean
	Spark Arrestor Screen	Screen cracked, plugged, or perforated	Normal wear	Replace
Engine does not crank	N/A	N/A	Internal engine problem	See your Echo dealer

WARNING DANGER

Fuel vapors are **extremely** flammable and may cause fire and/or explosion. **Never** test for ignition spark by grounding spark plug near cylinder plug hole, otherwise serious personal injury may result.

STORAGE

Long Term Storage (over 30 days)

WARNING  **DANGER**

During operation the muffler or catalytic muffler and surrounding cover become hot. Always keep exhaust area clear of flammable debris during transportation or when storing, otherwise serious property damage or personal injury may result.

Do not store your unit for a prolonged period of time (30 days or longer) without performing protective storage maintenance which includes the following:

1. Store unit in a dry, dust free place, out of the reach of children with drive shaft housing in an upright or horizontal position to prevent grease leakage.

WARNING  **DANGER**

Do not store in enclosure where fuel fumes may accumulate or reach an open flame or spark.

2. Place the stop switch in the "OFF" position.
3. Remove accumulation of grease, oil, dirt and debris from exterior of unit.
4. Perform all periodic lubrication and services that are required.
5. Tighten all the screws and nuts.
6. **Drain** the fuel tank **completely** and pull the recoil starter handle several times to remove fuel from the carburetor.
7. Remove the spark plug and pour 7 cc (1/4 oz.) of fresh, clean, two-stroke engine oil into the cylinder through the spark plug hole.
 - A. Place a clean cloth over the spark plug hole.
 - B. Pull the recoil starter handle 2-3 times to distribute the oil inside the engine.
 - C. Observe the piston location through the spark plug hole. Pull the recoil starter handle slowly until the piston reaches the top of its travel and leave it there.
8. Install the spark plug (do not connect ignition cable).

SPECIFICATIONS

MODEL -----	PAS-230
Unit Length -----	1025 mm (40.4 in.)
Width -----	250 mm (9.84 in.)
Height -----	250 mm (9.84 in.)
Weight (dry) -----	4.0 kg (8.82 lb.)
Engine Type -----	Air cooled, two-stroke, single cylinder gasoline engine
Bore -----	32.2 mm (1.27 in.)
Stroke -----	28.0 mm (1.10 in.)
Displacement -----	22.8 cc (1.39 cu. in.)
Exhaust -----	Spark Arrestor Muffler with catalyst
Carburetor -----	Zama w/purge pump
Ignition System -----	CDI (capacitor discharge ignition)
Spark Plug -----	NGK BPM-8Y Gap 0.65 mm (0.026 in.)
Fuel -----	Mixed (Gasoline and Two-stroke Oil)
Fuel/Oil Ratio -----	50:1 two-stroke air cooled engine oil
Gasoline -----	89 Octane unleaded. DO NOT use fuel containing methyl alcohol, more than 10% ethyl alcohol or 15% MTBE.
Oil -----	Power Blend™ Premium Universal 2-Stroke Oil
Fuel Tank Capacity -----	0.58 lit. (19.6 US fl. oz.)
Starter System -----	Automatic Rewind Starter
Clutch -----	Centrifugal Type
Drive Shaft -----	6.35 mm (1/4 in.) flexible shaft
Idle Speed -----	2,750 - 3,250
Wide Open Throttle Speed (W.O.T.) RPM -----	8,500 - 10,500

ECHO APPROVED OPTIONAL ATTACHMENTS

WARNING DANGER

- Use only ECHO approved attachments for Pro Attachment Series™ models. Serious injury may result from the use of non-approved attachment combinations. Read and comply with all safety instructions listed in this manual and in the attachment manual.

RECOMMENDED OPTIONAL ATTACHMENTS

• PAS Edger	Model 99944200470	• PAS Pro Sweep™	Model 99944200550
• PAS Cultivator	Model 99944200510	• PAS Pro Thatch™	Model 99944200560
• PAS Trimmer	Model 99944200540	• PAS Articulating Hedge Clipper	Model 99944200590
• PAS Hedge Clipper	Model 99944200480	• PAS Rapid Loader™	Model 99944200610
• PAS Power Pruner™	Model 99944200530	• PAS Brush Cutter	Model 99944200600
		• PAS ProPaddle	Model 99944200620

NOTE

ECHO, INC. will not be responsible for the failure of cutting devices, attachments, or accessories which have not been tested and approved by ECHO for use with this Pro Attachment Series™ unit.

NOTES

SERVICING INFORMATION

PARTS/SERIAL NUMBER

Genuine ECHO Parts and ECHO REPOWER™ Parts and Assemblies for your ECHO products are available only from an Authorized ECHO Dealer. When you do need to buy parts **always** have the Model Number and Serial Number of the unit with you. You can find these numbers on the engine housing. For future reference, write them in the space provided below.

Model No. _____ SN. _____

SERVICE

Service of this product during the warranty period must be performed by an Authorized ECHO Service Dealer. For the name and address of the Authorized ECHO Service Dealer nearest you, ask your retailer or call: 1-800-432-ECHO (3246). Dealer information is also available on our Web Site. When presenting your unit for Warranty service/repairs, proof of purchase is required.

ECHO CONSUMER PRODUCT SUPPORT

If you require assistance or have questions concerning the application, operation or maintenance of this product you may call the ECHO Consumer Product Support Department at 1-800-673-1558 from 8:30 am to 4:30 pm (Central Standard Time) Monday through Friday. Before calling, please know the model and serial number of your unit to help your Consumer Product Support Representative.

WARRANTY REGISTRATION

You may register your Echo equipment using the warranty registration card or register on-line at www.echo-usa.com. Registering provides a direct link between you and ECHO if we find it necessary to contact you.

ADDITIONAL OR REPLACEMENT MANUALS

Safety Manuals in English/Spanish or English/French are available, free of charge, from your ECHO dealer or at www.echo-usa.com.

Operator's and Parts Manuals are available by:

- Downloading free from www.echo-usa.com
- Purchasing from your Echo Dealer.
- Manuals are available by sending a written request stating the model number and serial number of your Echo unit, part number of the manual, your name and address, and mail to the address below.

Safety Videos are available from your Echo dealer. A \$5.00 shipping charge will be required for each video.



DEALER?

Call
1-800-432-ECHO
or
www.echo-usa.com

CONSUMER PRODUCT SUPPORT

1-800-673-1558
8:30 - 4:30 Mon - Fri C.S.T.



ECHO

ECHO, INCORPORATED

400 OAKWOOD ROAD
LAKE ZURICH, IL 60047

www.echo-usa.com

06001001/06999999

Free Manuals Download Website

<http://myh66.com>

<http://usermanuals.us>

<http://www.somanuals.com>

<http://www.4manuals.cc>

<http://www.manual-lib.com>

<http://www.404manual.com>

<http://www.luxmanual.com>

<http://aubethermostatmanual.com>

Golf course search by state

<http://golfingnear.com>

Email search by domain

<http://emailbydomain.com>

Auto manuals search

<http://auto.somanuals.com>

TV manuals search

<http://tv.somanuals.com>