



Shaft Hedge Clipper

Operator's Manual

MODEL:

HCA-261

Serial Number 002001001 - 02999999

WARNING  **DANGER**



The muffler or catalytic muffler and surrounding cover may become extremely hot.

Always keep clear of exhaust and muffler area, otherwise serious personal injury may occur.



WARNING 

The engine exhaust from this product contains chemicals known to the State of California to cause cancer, birth defects or other reproductive harm.



WARNING  **DANGER**

Read rules for safe operation and instructions carefully. ECHO provides an Operator's Manual and a Safety Manual. Both must be read and understood for proper and safe operation. Failure to do so could result in serious injury.



SUPPLEMENT TO OPERATOR'S MANUAL

Model HCA-260, HCA-261

Serial Number: All

*This Supplement contains important information. Please keep with your Operator's Manual.
The following section has been added:*

OPERATION

ROTATE CUTTER ASSEMBLY

Always use the unit from the right-hand side of your body – NEVER from the left side. Rotate cutter assembly 180 degrees on driveshaft in order to avoid cutting directly above your head, and to avoid contact with hot muffler.

1. Loosen gearcase clamping screw (A), hand guard clamping screw (B), and remove gearcase locating screw (C).
2. Rotate cutter assembly 180-degrees on driveshaft until locating hole in driveshaft is visible through locating hole in gearcase.
3. Install gearcase locating screw (C), and securely tighten all hardware.

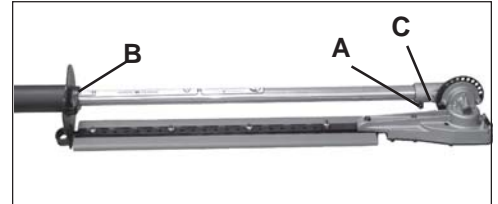

WARNING DANGER

Hedge Clipper blades are very sharp. Wear gloves to protect hands when rotating cutter assembly or serious personal injury may result.

WARNING DANGER

During operation, the complete unit, especially the drive shaft housing and gearcase may become too hot to touch. Avoid contact when rotating cutter assembly.

SUPLEMENTO DEL MANUAL DEL OPERADOR

Modelo HCA-260, HCA-261

Número de serie: Todas

*Este suplemento contiene la información importante.
Guarde por favor con el manual de su operador.
La sección siguiente se ha agregado:*

OPERACIÓN

PARA GIRAR EL CONJUNTO DE CORTADOR

Use siempre la unidad del lado derecho de su cuerpo - NO USE NUNCA la del lado izquierdo. Gire 180 grados el conjunto de cortador en el eje de impulsión para no cortar directamente por encima de la cabeza, y para no hacer contacto con el silenciador caliente.

1. Afloje el tornillo de sujeción de la caja de engranajes(A), el tornillo de sujeción del protector de la mano (B) y quite el tornillo guía de la caja de engranajes (C).
2. Gire 180 grados el conjunto de cortador en el eje de impulsión hasta que se pueda ver el agujero de guía por el agujero de guía de la caja de engranajes.
3. Instale el tornillo guía de la caja de engranajes (C) y apriete bien toda la tornillería.

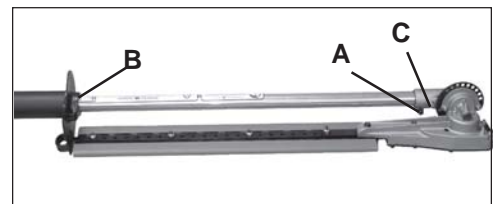

SUP22203863

99922203863
08/05

ADVERTENCIA PELIGRO

Las hojas del cortasetos están muy afiladas. Lleve guantes para protegerse las manos al girar el conjunto de cortador, ya que de lo contrario se pueden producir lesiones personales.

ADVERTENCIA PELIGRO

Durante la operación, la unidad completa, especialmente la caja del eje de impulsión y la caja de engranajes pueden calentarse demasiado al tacto. Evite el contacto al girar el conjunto de cortador:

SUPPLÉMENT AU MANUEL DE L'OPÉRATEUR Modèle: HCA-260, HCA-261 Numéro de série: Tous

*Ce supplément contient l'information importante. Veuillez le garder avec le manuel de votre opérateur.
La section suivante a été ajoutée:*

UTILISATION

ROTATION DE LA TÊTE DE COUPE

Toujours utiliser l'outil en le tenant à la droite du corps – JAMAIS à la gauche.
Tourner la tête de coupe de 180 degrés sur l'arbre moteur, pour éviter de couper directement au-dessus de soi et d'éviter le contact avec l'échappement brûlant.

1. Desserrer la vis de fixation du carter d'engrenages (A), la vis de fixation de la garde de main (B) et retirer la vis de guidage du carter d'engrenages (C).
2. Tourner la tête de coupe de 180 degrés sur l'arbre moteur, de façon à ce que le trou de l'arbre soit visible au travers de celui du carter d'engrenages.
3. Installer la vis de guidage du carter d'engrenages(C) et serrer fermement toute la boulonnerie.

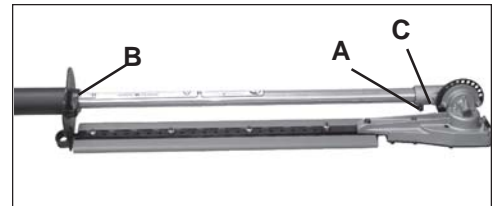

AVERTISSEMENT DANGER

Porter des gants lors de la manipulation de l'accessoire de coupe pour éviter des risques de blessures graves.

AVERTISSEMENT DANGER

Pendant le fonctionnement, l'ensemble de l'outil, en particulier le boîtier de l'arbre moteur et le carter d'engrenages peuvent devenir trop chauds pour être touchés. Éviter le contact avec ces pièces lors de la rotation du carter d'engrenages.

INTRODUCTION

Welcome to the ECHO family. This ECHO product was designed and manufactured to provide long life and on-the-job dependability. Read and understand this manual and the SAFETY MANUAL you found in the same package. You will find both easy to use and full of helpful operating tips and SAFETY messages.

WARNING DANGER

Read rules for safe operation and instructions carefully. ECHO provides an Operator's Manual and a Safety Manual. Both must be read and understood for proper and safe operation.

THE OPERATORS MANUAL

contains specifications and information for operation, starting, stopping, maintenance, storage and assembly specific to this product.

THE SAFETY MANUAL

explains possible hazards involved with the use of Hedge Clippers and what measures you should take to make their use safer.

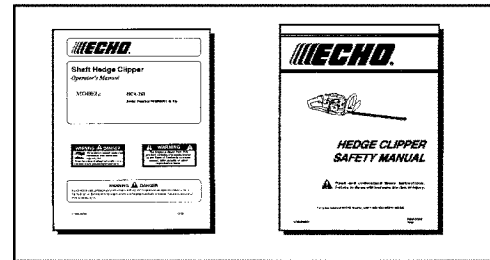

TABLE OF CONTENTS

Introduction	2	- Starting Cold Engine	19
- The Operator's Manual	2	- Starting Warm Engine	20
- The Safety manual	2	- Stopping Engine	21
Manual Safety Symbols and Important Information	3	Maintenance	21
Safety	3	- Skill Level	21
- Decals	3	- Maintenance Intervals	22
- International Symbols	4	- Air Filter	23
- Equipment	4	- Fuel Filter	23
- Fuel	5	- Spark Plug	24
- Personal Condition and Safety Equipment	6	- Cooling System Cleaning	24
- Safe Operation	7	- Exhaust System	25
- Extended Operation/Extreme Conditions	9	- Carburetor Adjustment	26
Description	10	- Lubrication	27
- Contents	10	- Sharpening Blades	29
- Emission Control	10	Troubleshooting	30
Specifications	13	Storage	31
Assembly	14 *	Servicing Information	32
- Gear Housing Assembly / Drive Shaft	14	- Parts	32
- Drive Shaft Assembly / Power Head	14	- Service	32
- Throttle Linkage and Ignition Leads	15	- ECHO Consumer Product Support	32
Pre-Operation	15	- Warranty Card	32
- Fuel	15	- Additional or Replacement Manuals	32
- Equipment Check	17	- Manual Ordering Instructions	32
- Determine Operation Area	17	*Page 14 Supplement	33
Operation	18		

Specifications, descriptions and illustrative material in this literature are as accurate as known at the time of publication, but are subject to change without notice. Illustrations may include optional equipment and accessories, and may not include all standard equipment.

MANUAL SAFETY SYMBOLS AND IMPORTANT INFORMATION

Throughout this manual and on the product itself, you will find safety alerts and helpful, information messages preceded by symbols or key words. The following is an explanation of those symbols and key words and what they mean to you.



This symbol accompanied by the words **WARNING** and **DANGER** calls attention to an act or condition that can lead to serious personal injury to operator and bystanders.



The circle with the slash symbol means whatever is shown within the circle is prohibited.

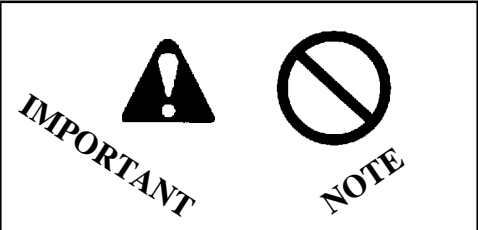

IMPORTANT

The enclosed message provides information necessary for the protection of the unit.

NOTE

This enclosed message provides tips for use, care and maintenance of the unit.

SAFETY

DECALS

Locate these safety decals on your unit. The complete unit illustration, found in the "DESCRIPTION" section, will help you locate them. Make sure the decals are legible and that you understand and follow the instructions on them. If a decal cannot be read, a new one can be ordered from your ECHO dealer. See PARTS ORDERING instructions for specific information.



P/N 890178-54331

WARNING DANGER

This unit is not designed to insulate against hazards associated with the contact of wires carrying electrical current.

To avoid possible injury/death due to electrical shock or other hazards. **DO NOT** operate unit if any wires (power, telephone, cable, etc.) are closer than 15 feet (4/5 meters) minimum distance, to any part of the unit or operator.



P/N 89016012360

WARNING DANGER

This unit can be dangerous if used improperly. • Falling objects and/or blade contact can cause serious injury to operator, helpers and bystanders. • Keep helpers and bystanders at least 50 feet (15m) clear of operating area. • To reduce injury risk, **READ AND UNDERSTAND** the operator's Manual, replacement copies are available through your ECHO dealer. • Wear Protective clothing (head, hearing and eye protection meeting ANSI standards) specified in the Operator's Manual. • **STOP** engine before making repairs or blade adjustments. • **ALWAYS** use adjustment handle when adjusting blade angle. • Keep hand away from blade.



Shaft Decal

Spanish Decal



ADVERTENCIA  PELIGRO

Esta unidad puede ser peligrosa y producir lesiones personales graves si no se usa en forma adecuada. Para reducir el riesgo de lesionarse, los operadores, los ayudantes y los espectadores deben leer y comprender el Manual Del Operador y los Manuales De Seguridad que se entregan escritos en español.











89022809560









English Translation

WARNING  DANGER

This unit can be dangerous and cause serious injury if improperly used. To reduce injury risk to operator, helpers and bystanders, read and understand the Operator's and Safety Manuals, which are provided in Spanish.

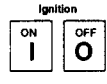
INTERNATIONAL SYMBOLS

Symbol form/shape	Symbol description/application	Symbol form/shape	Symbol description/application
	Read and understand Operator's Manual.		Fuel and oil mixture
	Wear eyes, ears and head protection		Finger Severing Hazard
	Wear slip resistant foot wear.		Wear hand protection. Use two handed.
	Hot Surface		DO NOT smoke near fuel.
	Safety/Alert		DO NOT allow flames or sparks near fuel.

Symbol form/shape	Symbol description/application	Symbol form/shape	Symbol description/application
	Avoid all power lines. This unit is not insulated against electrical current.		Do not operate closer than 15 M (50 ft.) from electrical hazards.
	Keep bystanders at least 15 meters (50 feet) away.		Emergency stop
	Engine choke control.		Ignition ON/OFF
	Primer bulb		Carburetor adjustment - High speed mixture
	Carburetor adjustment - Low speed mixture		Carburetor adjustment - Idle speed

EQUIPMENT

Before operation a complete check of the unit must be performed;

- Check unit for loose/missing nuts, bolts and screws. Tighten and/or replace as needed.
- Inspect fuel lines, tank and area around carburetor for fuel leaks. DO NOT operate unit if leaks are found.
- Check that the blade assembly is firmly attached and in safe operating condition. Dull, loose or damaged blades should not be used.



- Check that shoulder harness is adjusted for safe, comfortable operation.
- Tighten the blade angle adjustment lever before operating.

Spark Arrestor - Catalytic Muffler / Muffler

- The muffler or catalytic muffler controls the exhaust noise and emissions. The spark arrestor screen prevents hot, glowing particles of carbon from leaving the muffler. Make sure the spark arrestor screen is in good repair and properly seated in the muffler. Keep exhaust area clear of flammable debris. Avoid contact during and immediately after operation.



- Do not use shaft hedge clipper if any part is missing or damaged.
- Have repairs done only by an authorized ECHO Service Dealer.
- Do not use any attachment, accessory or replacement part unless it is recommended in this Operator's Manual.

FUEL

WARNING  DANGER

Fuel is **VERY** flammable. Use extreme care when mixing, storing or handling, otherwise serious personal injury may result.

- Use an approved fuel container.
- **DO NOT** smoke near fuel.
- **DO NOT** allow flames or sparks near fuel.
- Fuel tanks/cans may be under pressure. Always loosen fuel caps slowly allowing pressure to equalize.
- **NEVER** refuel a unit when the engine is **HOT!**
- **NEVER** refuel a unit with the engine running.
- **DO NOT** fill fuel tanks indoors. **ALWAYS** fill fuel tanks outdoors over bare ground.
- Securely tighten fuel cap after refueling.
- Inspect for fuel leakage. If fuel leakage is found, do not start or operate unit until leakage is repaired.



IMPORTANT

Spilled fuel is a leading cause of hydrocarbon emissions. Some states may require the use of automatic fuel shut-off containers to reduce fuel spillage. Contact your ECHO dealer for ordering information.



After Refueling;

- Wipe any spilled fuel from the unit.
- Move at least 3 M (10 ft.) from refueling location before starting.

After Use;

- DO NOT store a unit with fuel in its tank. Leaks can occur. Return unused fuel to an approved fuel storage container.

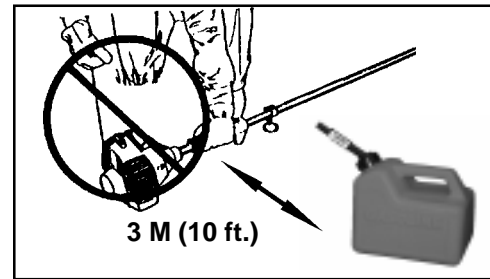

PERSONAL CONDITION AND SAFETY EQUIPMENT

WARNING DANGER

Hedge Clipper users risk injury to themselves and others if the shaft hedge clipper is used improperly and or safety precautions are not followed. Proper clothing and safety gear must be worn when operating a shaft hedge clipper.

Physical Condition

Your judgment and physical dexterity may not be good:

- if you are tired or sick,
- if you are taking medication,
- if you have taken alcohol or drugs.

Operate unit only if you are physically and mentally well.

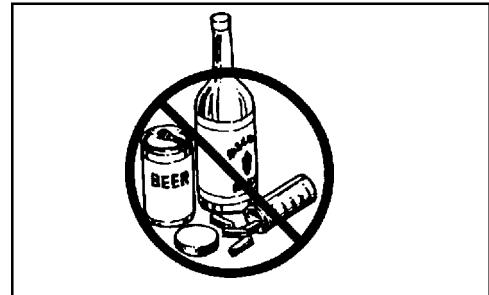

Eye Protection

Wear eye protection that meets ANSI Z87.1 or CE requirements whenever you operate the unit.

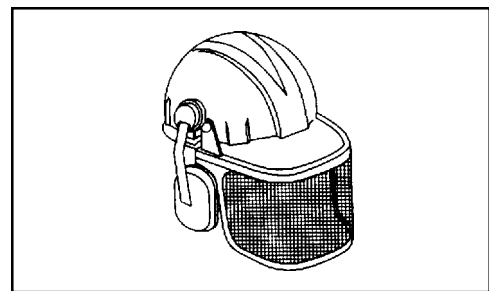

Face and Head Protection

When trimming overhead, wear head protection meeting ANSI Z89.1 with a full face shield.

Hand Protection

Wear no-slip, heavy duty work gloves to improve your grip on the unit handles. Gloves also reduce the transmission of machine vibration to your hands.

Hearing Protection

Wear hearing protection. ECHO recommends wearing hearing protection whenever unit is used.

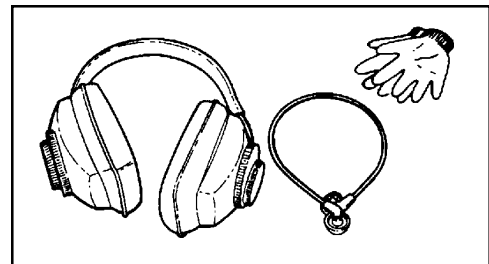

Proper Clothing

Wear snug fitting, durable clothing;

- Pants should have long legs, shirts with long sleeves.
- DO NOT WEAR SHORTS,
- DO NOT WEAR TIES, SCARVES, JEWELRY.

Wear sturdy work shoes with non-skid soles;

- DO NOT WEAR OPEN TOED SHOES,
- DO NOT OPERATE UNIT BAREFOOTED.

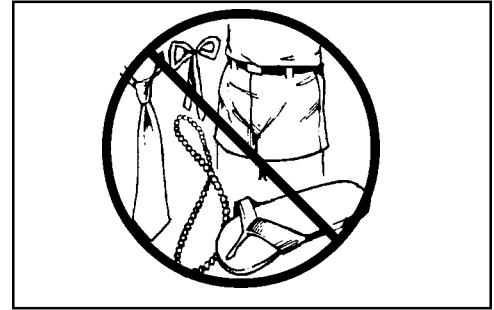

Hot Humid Weather

Heavy protective clothing can increase operator fatigue which may lead to heat stroke. Schedule heavy work for early morning or late afternoon hours when temperatures are cooler.

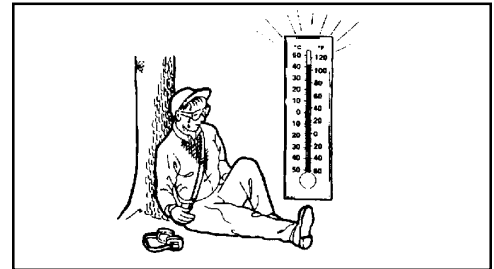

SAFE OPERATION

Determine Operation Area

- Provide all operators of this equipment with the Operator's Manuals and instructions for safe operation.
- Review the area to be trimmed. Look for hazards that could contribute to unsafe conditions. DO NOT operate unit if any wires (power, telephone, cable, etc.) are closer than 4.5 M (15 ft.) to any part of the operator or unit.
- Spectators and fellow workers must be warned, and children and animals prevented from coming nearer than 15 M (50 ft.) while the Hedge Clipper is in use.

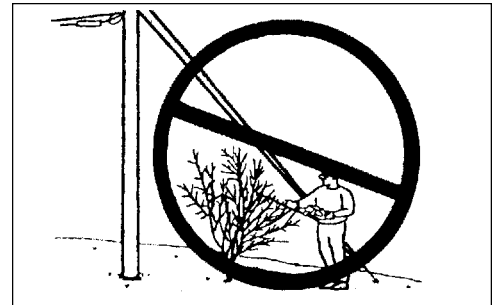

Operation

WARNING DANGER

Do not operate this product indoors or in inadequately ventilated areas. Engine exhaust contains poisonous emissions and can cause serious injury or death.

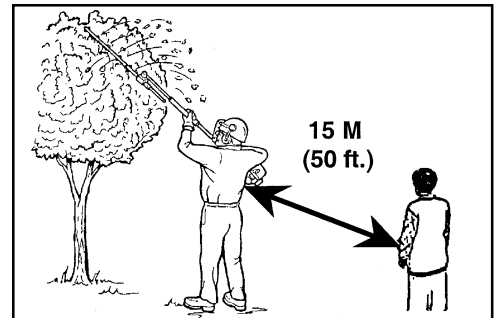

Use Proper Clothing & Equipment

- Before starting the unit, equip yourself and any other person working within the 15 M (50 ft.) Safety Zone with the required Protective Equipment and clothing.

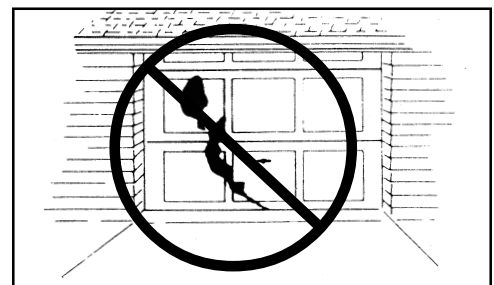

Avoid Hot Surfaces

- During operation, the muffler or catalytic muffler and surrounding cover may become extremely hot. Avoid contact during and immediately after operation. Always keep exhaust area clear of flammable debris. Allow the engine and muffler to completely cool before performing any maintenance activity.

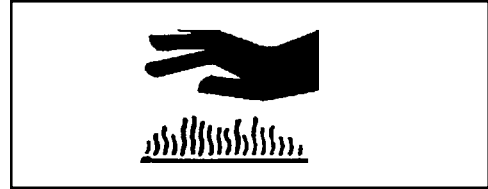

Keep A Firm Grip

- Hold the front and rear handles with both hands with thumbs and fingers tightly encircling the handles



Keep A Solid Stance

- Maintain footing and balance at all times. Do not stand on slippery, uneven or unstable surfaces. Do not work in odd positions or on ladders. Do not over reach.
- Never adjust blade angle of HCA while standing.
- Only adjust cutting angle with HCA resting flat on the ground, with the switch in the "STOP" position.

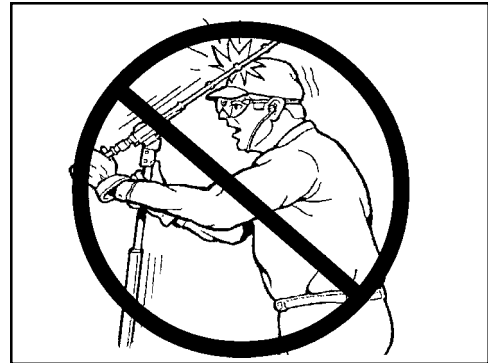

- Adjust cutting angle by moving locking lever (A) up. Depress blade indexing lever (B) and change blade angle with rear cutter assembly handle. Release indexing lever into notch. Move locking lever down to completely engage internal gears.

IMPORTANT

Lever (A) does not secure gearbox angle setting. Moving lever in the down position reduces internal play in the gear box. Do not over tighten nut (C) to insure gear box angle setting tightness because damage to internal gears will occur. If the lever is loose or very tight adjust nut (C) for snug 90° movement.

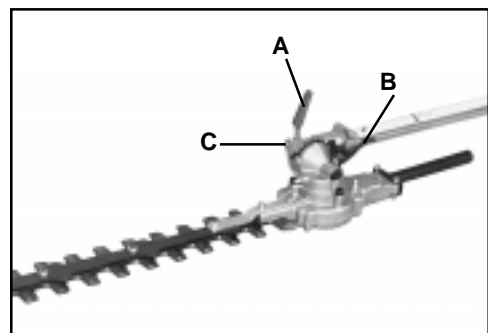

EXTENDED OPERATION/EXTREME CONDITIONS

Vibration and Cold

It is believed that a condition called Raynaud's Phenomenon, which affects the fingers of certain individuals may be brought about by exposure to vibration and cold. Exposure to vibration and cold may cause tingling and burning sensations followed by loss of color and numbness in the fingers. The following precautions are strongly recommended because the minimum exposure which might trigger the ailment is unknown.

- Keep your body warm, especially the head, neck, feet, ankles, hands and wrists.
- Maintain good blood circulation by performing vigorous arm exercises during frequent work breaks and also by not smoking.
- Limit the hours of operation. Try to fill each day with jobs where operating the trimmer or other hand-held power equipment is not required.
- If you experience discomfort, redness and swelling of the fingers followed by whitening and loss of feeling, consult your physician before further exposing yourself to cold and vibration.

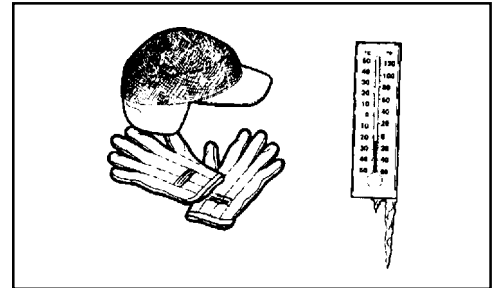

Repetitive Stress Injuries

It is believed that overusing the muscles and tendons of the fingers, hands, arms and shoulders may cause soreness, swelling, numbness, weakness and extreme pain in those areas. Certain repetitive hand activities may put you at a high risk for developing a Repetitive Stress Injury (RSI). An extreme RSI condition is Carpal Tunnel Syndrome (CTS), which could occur when your wrist swells and squeezes a vital nerve that runs through the area. Some believe that prolonged exposure to vibration may contribute to CTS. CTS can cause severe pain for months or even years.

To reduce the risk of RSI/CTS, do the following:

- Avoid using your wrist in a bent, extended or twisted position. Instead try to maintain a straight wrist position. Also, when grasping, use your whole hand, not just the thumb and index finger.
- Take periodic breaks to minimize repetition and rest your hands.
- Reduce the speed and force with which you do the repetitive movement.
- Do exercises to strengthen the hand and arm muscles.
- Immediately stop using all power equipment and consult a doctor if you feel tingling, numbness or pain in the fingers, hands, wrists or arms. The sooner RSI/CTS is diagnosed, the more likely permanent nerve and muscle damage can be prevented.

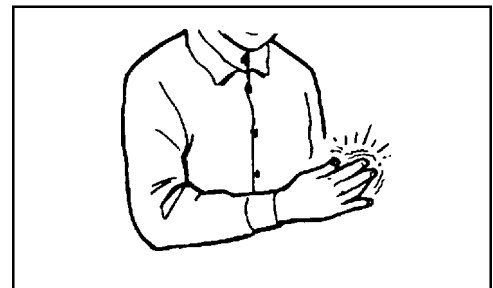
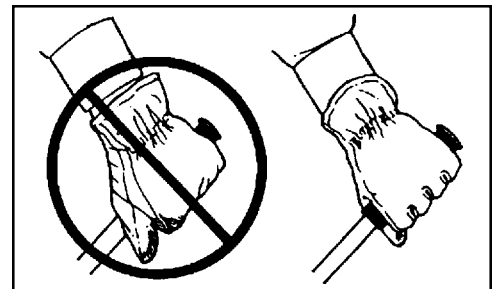

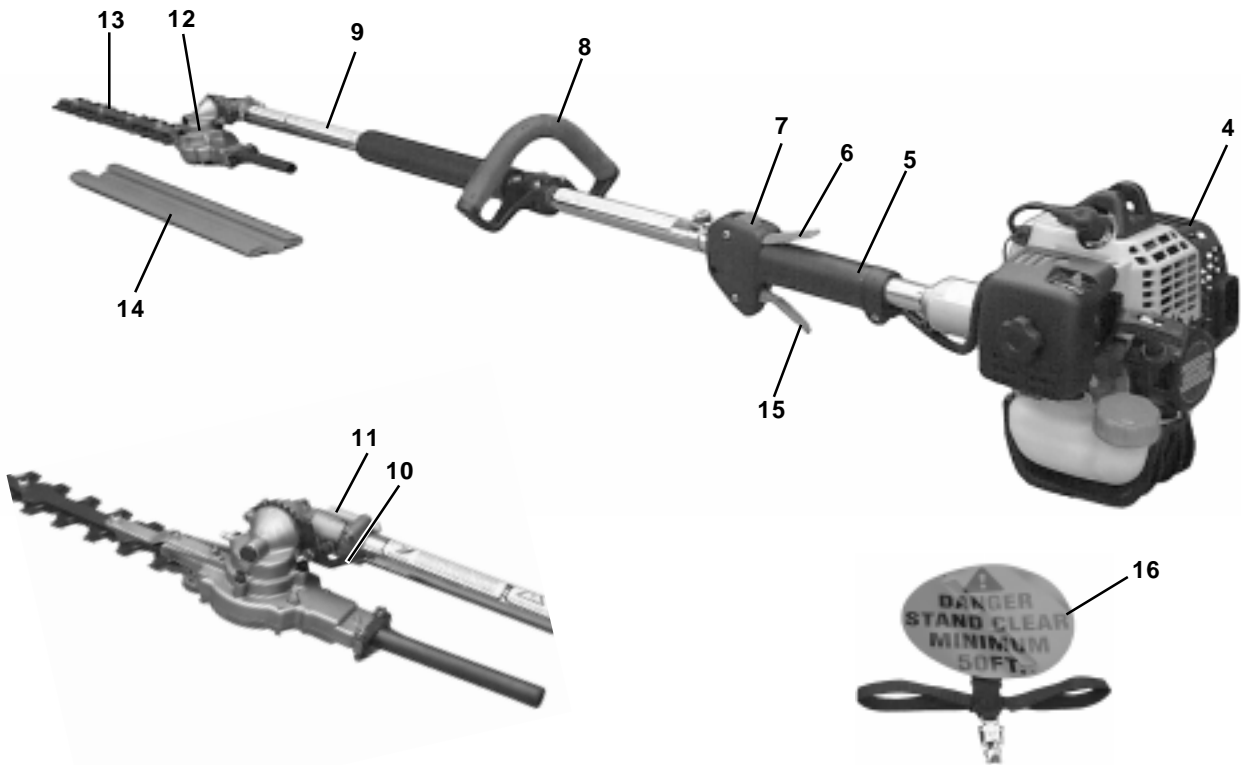
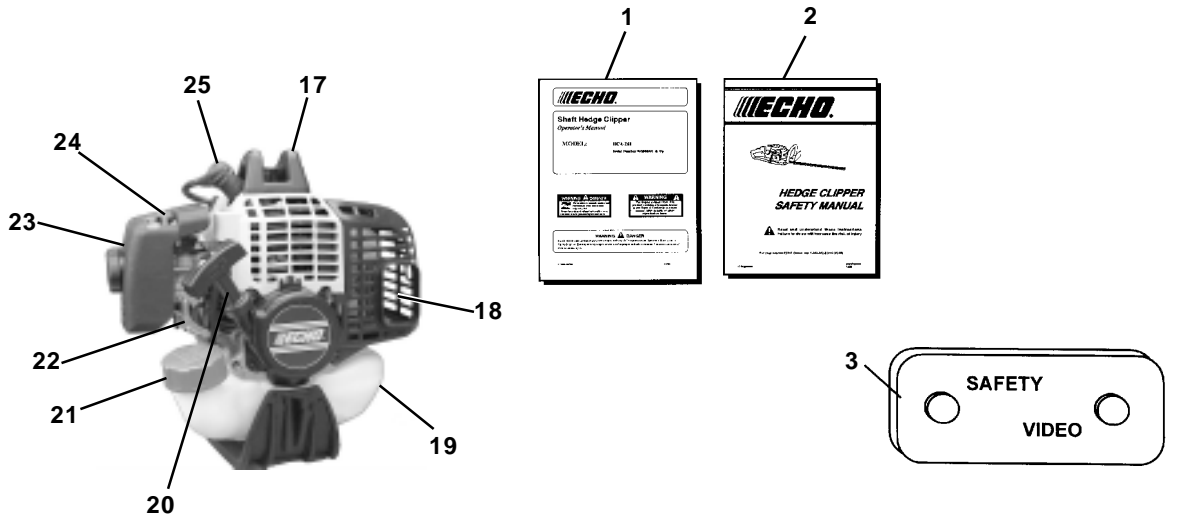

1. **OPERATORS MANUAL** - Read and understand this manual before operation. Keep manual in a safe location for future reference, i.e., operation, maintenance, storage and specifications.
2. **SAFETY MANUAL** - Read and understand this manual before operation. Keep manual in a safe location as a reference for safe operating techniques.
3. **HEDGE CLIPPER SAFETY VIDEO** - P/N 99922202800 (Not included with unit and English version only) is available for your review and purchase at a cost of \$5.00 from ECHO, INC. or any authorized ECHO dealer. The video overviews safety precautions and proper operating techniques provided in detail in the Safety Manual, and is supplemental to the Safety Manual. Read and understand the Safety Manual for complete information on safe operation.
4. **POWER HEAD** - Factory Assembled. Includes the Engine, Clutch, Fuel System, Ignition System and Starter.
5. **GRIP, RIGHT HAND, REAR** - Cushioned grip for Right Hand.
6. **IDLE START INTERLOCK** - This lever must be held during starting and idle operation when throttle trigger is disengaged, otherwise engine will stop. The engine does not stop when trigger interlock lever is released and throttle trigger is engaged during throttle operation. Operation of the throttle trigger is prevented unless interlock lever is engaged.
7. **"STOP SWITCH"** mounted on top of the Throttle Trigger Housing. Move switch FORWARD to RUN, BACK to STOP.
8. **FRONT LEFT HAND LOOP HANDLE** - Adjustable, rubber grip loop handle for proper cutting attitude and operator comfort.
9. **DRIVE SHAFT ASSEMBLY** - Contains the Flexible Drive Cable.
10. **BLADE ANGLE INDEXING LEVER** - Spring loaded lever that engages with a notch every 15 degrees, from the straight (in line with drive shaft) position to right angle with the drive shaft.
11. **BLADE ANGLE LOCKING LEVER** - The lever does not secure gear box angle setting. This lever MUST be placed in the engaged (tight) position to remove internal gear play before operating the hedge clipper.
12. **GEAR HOUSING ASSEMBLY** - Gear housing assembly cutting angle is adjustable through a 90° arc.
13. **BLADES** - Double reciprocating blades mounted to a blade support bar. Double sided blades, are capable of cutting on either side of the blade.
14. **BLADE COVER** - Used to cover blade during transport and storage. Remove blade cover before using unit.
15. **THROTTLE TRIGGER** - Spring loaded to return to idle when released. During acceleration, depress gradually for best operating technique.
16. **SHOULDER HARNESS** - An adjustable strap that suspends the unit from the operator.
17. **ARM REST** - Provides arm rest during operation and protects arm from the hot engine.
18. **SPARK ARRESTOR - CATALYTIC MUFFLER/MUFFLER** - The muffler or catalytic muffler controls exhaust noise and emission. The spark arrestor screen prevents hot, glowing particles of carbon from leaving the muffler. Keep exhaust area clear of flammable debris.
19. **FUEL TANK** - Contains fuel and fuel filter.
20. **RECOIL STARTER HANDLE** - Pull handle slowly until starter engages, then quickly and firmly. **DO NOT** pull rope all the way out or allow the handle to snap back, damage to the starter will occur.
21. **FUEL TANK CAP** - Covers and seals fuel tank opening.
22. **PRIMER BULB** - Pumping primer bulb before starting engine draws fresh fuel from the fuel tank priming the carburetor for starting. Pump primer bulb until fuel is visible and flows freely in the clear fuel tank return line. Pump bulb an additional 4 or 5 times.
23. **AIR CLEANER** - Contains replaceable filter element.
24. **CHOKE CONTROL** - The choke control lever is located on the top of air cleaner housing. Move the lever to "COLD START" to close choke for cold starting. Move lever to "RUN" to open choke.
25. **SPARK PLUG** - Provides spark to ignite fuel mixture.

SPECIFICATIONS

MODEL	
Length	20
Width	25
Height	25
Weight (dry) *	6
Engine Type	Air cooled, two-strok
Bore	34
Stroke	28
Displacement	25.
Exhaust System	Spark Arr
Carburetor	Walbro Diaphra
Ignition System	Flywheel Magneto, (
Spark Plug	
Fuel	Mixed (Gas
Fuel/Oil Ratio	50:1 ECHO High Perform
Gasoline	89 Octane unleaded. DO more than 10%

ASSEMBLY

GEAR HOUSING ASSEMBLY / DRIVE SHAFT

Tools Required: 8mm x 10mm Open End Wrench

Parts Required: Power Head/Drive Shaft Assembly and Gear Housing Assembly.

NOTE

Hedge Clipper Blades are very sharp. Wear gloves to protect hands.

1. Slide the Gear Housing Assembly on the Drive Shaft. Be certain the Flex Drive Shaft engages the hole in Driver Gear.
2. Align the locating screw (A) with the locating hole (B) in the Drive Shaft Housing, tighten screw (A) and clamping screws (C).

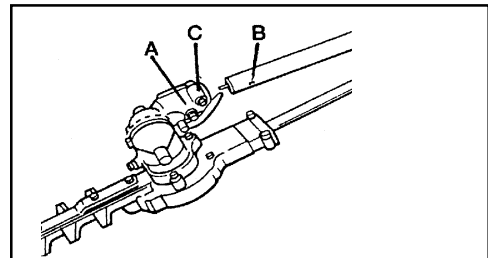

DRIVE SHAFT ASSEMBLY / POWER HEAD

Tools Required: 4mm Hex Wrench

Parts Required: Power Head, Drive Shaft Assembly

1. Loosen, the bolt (A) at engine drive shaft clamp.
2. Carefully fit drive shaft assembly to engine making sure that inner drive shaft engages into clutch mount.

NOTE

Lower gear housing cutter head assembly must be in line with the engine.

3. Turn drive shaft housing so that center line of housing is midway between the two arrows on shaft.
4. Tighten bolt (A).

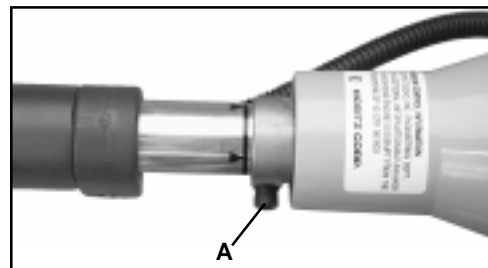
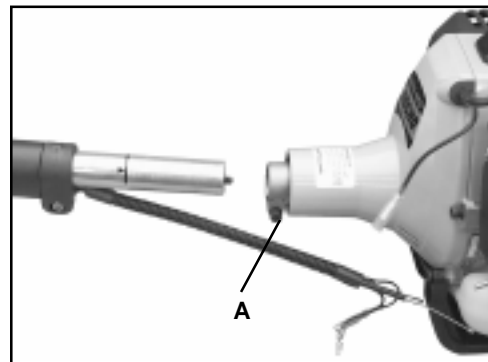

THROTTLE LINKAGE AND IGNITION LEADS

1. Close choke and remove air filter cover.
2. Loosen nut (A) and place threaded end of throttle linkage in bracket slot. Finger tighten nut (A).
3. Place inner cable in slot of carburetor swivel (B) and tighten nut (A).
4. Check throttle for freedom of movement and that wide open throttle / low idle extremes are adjusted properly. If adjustment cannot be achieved with adjusting nuts, consult with your Echo Dealer for correct adjustment procedure.
5. Connect ignition stop leads (C) and (D).
6. Bundle and secure ignition leads against engine housing with clip (E).
7. Install air filter and cover.

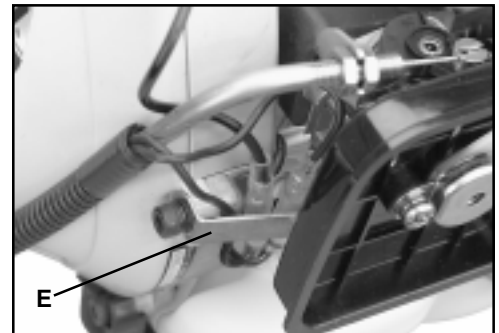
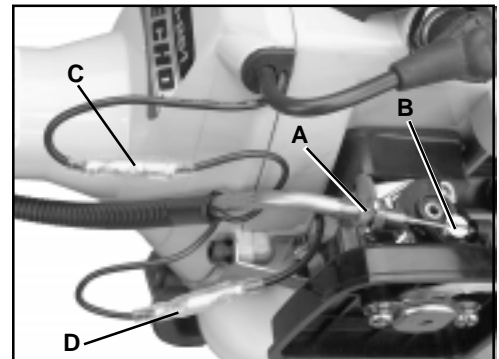

PRE-OPERATION FUEL

Fuel Requirements

Gasoline - Use 89 Octane $\left[\frac{R+M}{2} \right]$ (mid grade or higher) gasoline or gasohol known to be good quality. Gasohol may contain up to 10% Ethyl (grain) alcohol or 15% MTBE (methyl tertiary-butyl ether). Gasohol containing methyl (wood) alcohol is **NOT** approved.

Two Stroke Oil - A two-stroke engine oil meeting ISO-L-EGD (ISO/CD 13738) and JASO FC standards, must be used. Echo brand Premium 50:1 oil meets these standards. Engine problems due to inadequate lubrication caused by failure to use an ISO-L-EGD and JASO FC certified oil, such as Echo Premium 50:1 Two-stroke Oil, will void the two-stroke engine warranty. (Emission related parts only are covered for two years, regardless of two-stroke oil used, per the statement listed in the California Emission Defect Warranty Explanation.)

Mixing - Follow directions on the oil container.

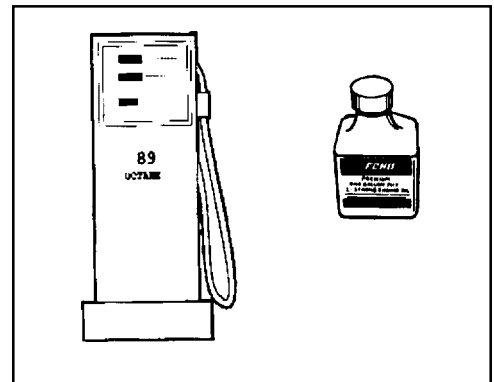

Handling Fuel

WARNING DANGER

Fuel is **VERY** flammable. Use extreme care when mixing, storing or handling, or serious personal injury may result.

- Use an approved fuel container.
- DO NOT smoke near fuel.
- DO NOT allow flames or sparks near fuel.
- Fuel tanks/cans may be under pressure. Always loosen fuel caps slowly allowing pressure to equalize.
- NEVER refuel a unit when the engine is HOT!
- NEVER refuel a unit with the engine running.
- DO NOT fill fuel tanks indoors. ALWAYS fill fuel tanks outdoors over bare ground.
- Securely tighten fuel cap after refueling.
- Inspect for fuel leakage. If fuel leakage is found, do not start or operate unit until leakage is repaired.

IMPORTANT

Spilled fuel is a leading cause of hydrocarbon emissions. Some states may require the use of automatic fuel shut-off containers to reduce fuel spillage. Contact your ECHO dealer for ordering information.

After refueling;

- Wipe any spilled fuel from the unit.
- Move at least 3 M (10 ft.) from refueling location before starting the engine.

After use;

- DO NOT store a unit with fuel in its tank. Leaks can occur. Return unused fuel to an approved fuel storage container.

Storage -

Fuel storage laws vary by locality. Contact your local government for the laws affecting your area. As a precaution, store fuel in an approved, air tight container. Store in a well ventilated, unoccupied building, away from sparks and flames. Do not store fuel longer than 30 days.

IMPORTANT

Stored fuel ages. Do not mix more fuel than you expect to use in thirty (30) days, ninety (90) days when a fuel stabilizer is added.

IMPORTANT

Stored two-stroke fuel may separate. ALWAYS shake fuel container thoroughly before each use.

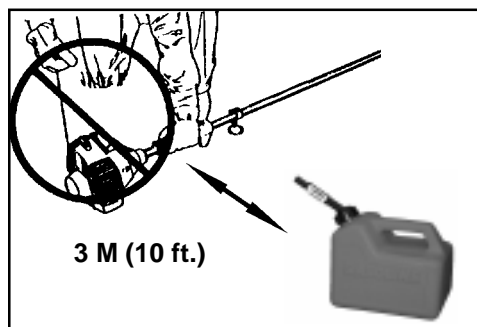

S	M	T	W	T	F	S
1	2	3	4	5	6	7
8	9	10	11	12	13	14
15	16	17	18	19	20	21
22	23	24	25	26	27	28
29	30	31				

EQUIPMENT CHECK

Before operation a complete check of the unit must be performed;

- Check unit for loose/missing nuts, bolts and screws. Tighten and/or replace as needed.
- Inspect fuel lines, tank and area around carburetor for fuel leaks. DO NOT operate unit if leaks are found.
- Check that the blade assembly is firmly attached and in safe operating condition. Dull, loose or damaged blades should not be used.
- Tighten the Blade angle adjustment lever before operating.
- Check that shoulder harness is adjusted for safe, comfortable operation.



DETERMINE OPERATION AREA

- Review the area to be trimmed. Look for hazards that could contribute to unsafe conditions. DO NOT operate unit if any wires (power, telephone, cable, etc.) are closer than 4.5 M (15 ft.) to any part of the operator or unit.
- Spectators and fellow workers must be warned, and children and animals prevented from coming nearer than 15 M (50 ft.) while the trimmer is in use.

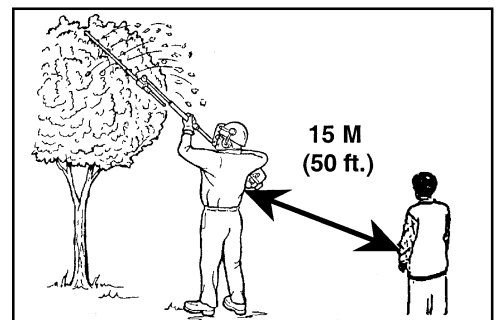
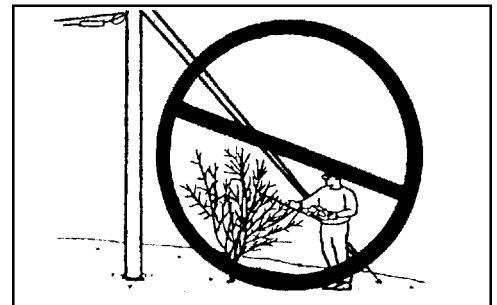

OPERATION

WARNING DANGER

Do not operate this product indoors or in inadequately ventilated areas. Engine exhaust contains poisonous emissions which can cause serious injury or death.

- Provide all operators of this equipment with the Operator's Manual and instructions for safe operation.
- Before starting the unit, equip yourself and any other person working within the 15 M (50 ft.) Safety Zone with the required Protective Equipment and clothing.
- Check that shoulder harness is adjusted for safe, comfortable operation.
- During operation, the muffler or catalytic muffler and surrounding cover may become extremely hot. Avoid contact during and immediately after operation. Always keep exhaust area clear of flammable debris. Allow the engine and muffler to completely cool before performing any maintenance activity.
- Never adjust blade angle while standing.
- Only adjust cutting angle with HCA resting flat on the ground, with the switch in the "STOP" position.
- Adjust cutting angle by moving locking lever (A) up. Depress blade indexing lever (B) and change blade angle with rear cutter assembly handle. Release indexing lever into notch. Move locking lever down to completely engage internal gears.

IMPORTANT

Locking lever (A) does not secure gear housing angle setting. Moving lever in the down position reduces internal play in the gear housing. Do not over tighten nut (C) to insure gear housing angle setting tightness because damage to internal gears will occur. If the lever is loose or very tight, adjust nut (C) for snug 90° movement.

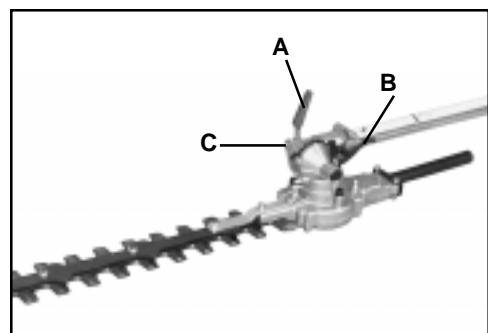
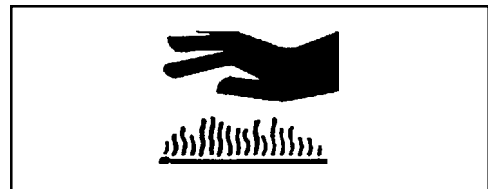
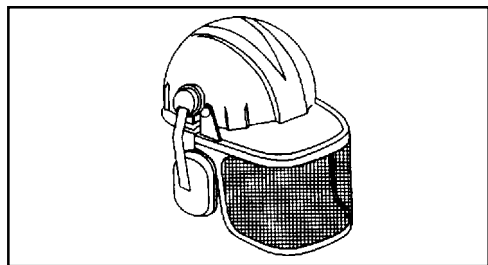
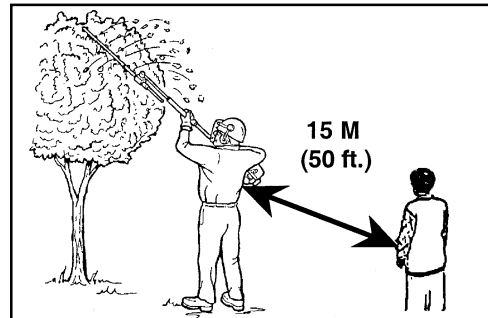

STARTING COLD ENGINE

WARNING DANGER

The blades should not move at idle. If blades move, readjust carburetor according to "Carburetor Adjustment" instructions in this manual or see your ECHO Dealer, otherwise serious personal injury may result.

1. *Stop Switch - Start/Run.*
Move stop switch button (A) forward away from the STOP position.

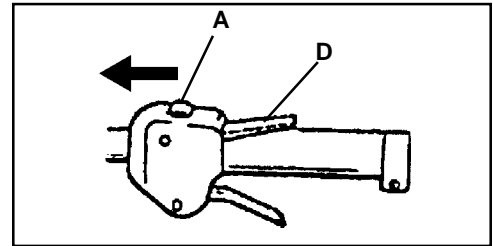

2. *Close Choke - Cold Start.*
Move choke lever (B) to Cold Start Position.

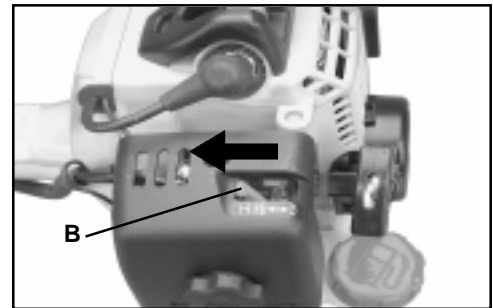

3. *Primer - Pump Bulb.*
Pump primer bulb (C) until fuel is visible and flows freely in the "Clear" fuel return line. Pump bulb an addition 4 or 5 times.

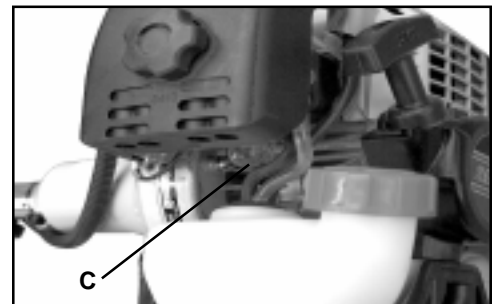

4. *Start - Pull Rope.*
Lay the hedge clipper on a flat clear area. Firmly grip the rear handle, depress and hold the "Idle Start Interlock Lever" (D). Pull the recoil starter handle (E) until engine fires.

NOTE

"Idle Start Interlock Lever" must be held tight against the grip or engine will stop at idle.

5. *Open Choke - Run.*
Move the choke lever to the OPEN - RUN position. Restart engine if necessary and allow to warm up running at idle for several minutes.

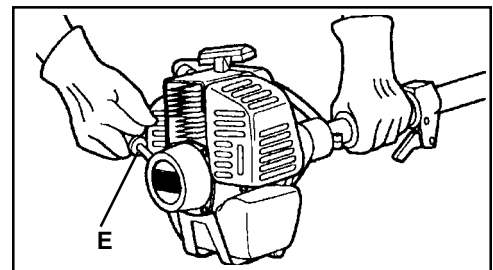

STARTING WARM ENGINE

The starting procedure is the same as Cold Start except DO NOT close the choke.

NOTE

If engine does not start after 5 pulls, use Cold Start Procedure.

WARNING DANGER

When engine starts, the cutting attachment may move even with the throttle trigger in idle (released) position.

1. *Stop Switch - Start/Run.* Move stop switch button (A) away from the STOP position.
2. *Primer - Pump Bulb.* Pump primer bulb (C) until fuel is visible and flows freely in the "Clear" fuel return line. Pump bulb an addition 4 or 5 times.
3. *Start - Pull Rope.* Lay the hedge clipper on a flat clear area. Firmly grip the rear handle, depress and hold the "Idle Start Interlock Lever" (D). Pull the recoil starter handle (E) until engine fires.

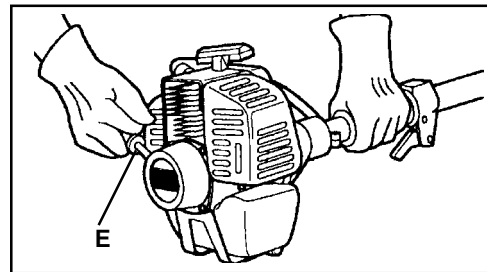
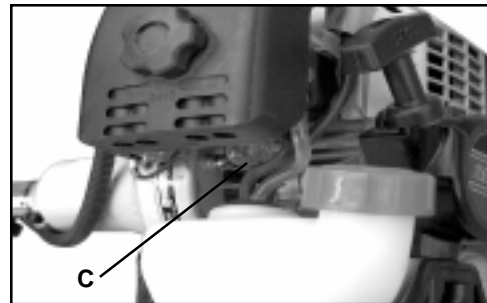
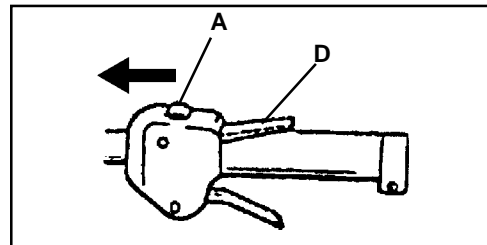

STOPPING ENGINE

1. *Release Throttle.* Allow engine to idle down and blades stop moving with throttle trigger disengaged.
2. *Release "Idle Start Interlock Lever" (D) -* Move "Stop Switch" to STOP position.

WARNING DANGER

The engine does not stop when idle start interlock lever is released and throttle trigger is engaged. Release throttle trigger and allow engine to idle down and blades stop moving before releasing idle start interlock lever, otherwise serious personal injury may result.

WARNING DANGER

If engine does not stop during step 2, close choke - COLD START position - to stall engine. Have your ECHO dealer repair stop switch before using hedge clipper again or serious personal injury may result.

NOTE

Refer to the Hedge Clipper Safety Manual for proper and safe hedge clipping operation.

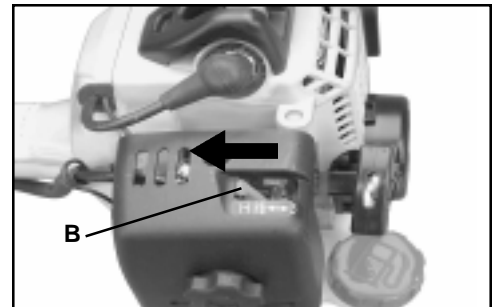
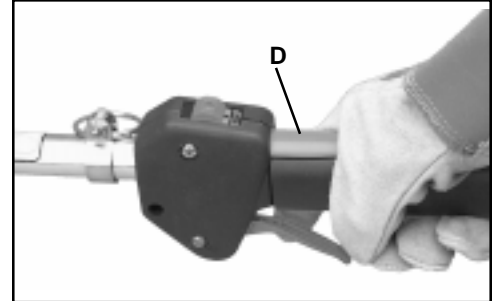

MAINTENANCE

Your ECHO product is designed to provide many hours of trouble free service. Regular scheduled maintenance will help achieve that goal. If you are unsure or are not equipped with the necessary tools, you may want to take your unit to an ECHO Service Dealer for maintenance. To help you decide whether you want to DO-IT-YOURSELF or have the ECHO Dealer do it, each maintenance task has been graded. If the task is not listed, see your ECHO Dealer for repairs.

SKILL LEVEL

- Level 1**= Easy to do. Most required tools come with unit.
- Level 2**= Moderate difficulty. Some specialized tools may be required.
- Level 3**= Experience required. Specialized tools are required. ECHO recommends that the unit be returned to your ECHO dealer for service

ECHO offers **REPOWER™** Maintenance Kits and Parts to make your maintenance job easier. Just below each task heading are listed the various part numbers required for that task. See your ECHO dealer for these parts.

MAINTENANCE INTERVALS

Component/System	Maintenance Procedure	Daily or Before Use
Air Filter	Clean / Replace	I / C
Fuel Strainer	Clean/Replace	
Fuel Line	Inspect/Replace	I
Carburetor	Inspect/Rebuild/ Replace	
Choke System	Inspect/Clean/ Replace	I / C
Cooling System	Inspect/Clean	I / C
Muffler Spark Arrestor	Inspect/Clean	
Cylinder Exhaust Port	Inspect/Clean/Decarbon	
Drive Shaft (Flex Cable Models)	Grease	
Gear Housing	Grease	
Recoil Starter Rope	Inspect/Clean	I

AIR FILTER

Level 1.

Tools required: 25 or 50 mm (1 or 2 in.) medium bristle paint brush.

Parts required: 90030 REPOWER™ Air & Fuel Filter Kit..

1. Close choke (Cold Start Position). This prevents dirt from entering the carburetor throat when the air filter is removed. Brush accumulated dirt from the air cleaner area.
2. Remove the air cleaner cover. Clean and inspect the element for damage. If element is fuel soaked and very dirty, replace.
3. If element can be cleaned and reused, be certain it:
 - still fits the cavity in the air cleaner cover.
 - is installed with the original side out.

NOTE

Carburetor adjustment may be needed after air filter cleaning or replacement. See Carburetor Adjustment Section.

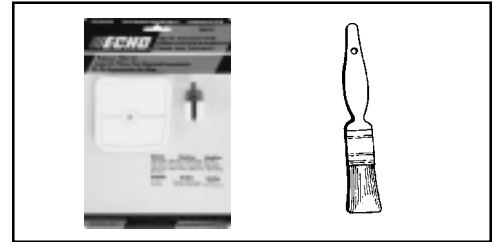

FUEL FILTER

Level 1.

Tools required: Fuel line hook, 203-254 mm (8 - 10 in.) length of wire with one end bent into a hook. Clean rag, funnel, and an approved fuel container.

Parts required: 90030 REPOWER™ Air & Fuel Filter Kit.

WARNING DANGER

Fuel is **VERY** flammable. Use extreme care when mixing, storing or handling.

1. Use a clean rag to remove loose dirt from around fuel cap and empty fuel tank.
2. Use the "fuel line hook" to pull the fuel line and filter from the tank.
3. Remove the filter from the line and install the new filter.

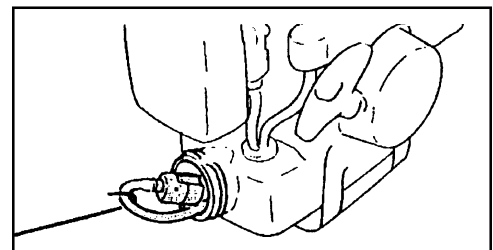
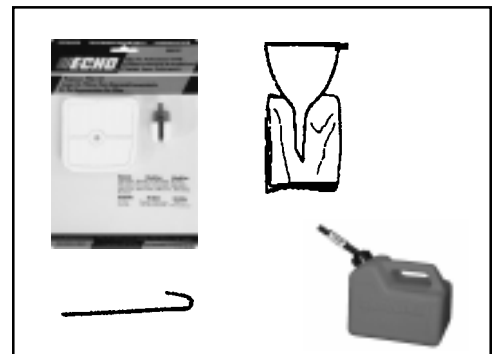

WARNING DANGER

Catalytic mufflers operate at extremely high temperatures. Muffler area must be kept clean. Do not perform maintenance on engine or muffler until engine and muffler are completely cool, otherwise serious personal injury may occur.

SPARK PLUG

Level 2.

Tools Required: Srench (combination socket wrench and screw driver supplied with unit) Feeler gauge, preferably a wire gauge. Soft Metal Brush.

Parts Required: 90065 REPOWER™ Tune-Up Kit

1. Remove spark plug and check for fouling, worn and rounded center electrode.
2. Clean the plug or replace with a new one. DO NOT sand blast to clean. Remaining sand will damage engine.
3. Adjust spark plug gap by bending outer electrode.
4. Tighten spark plug to 145-155 kg/cm (125-135 in. lb.).

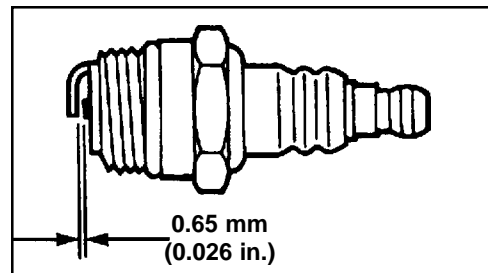
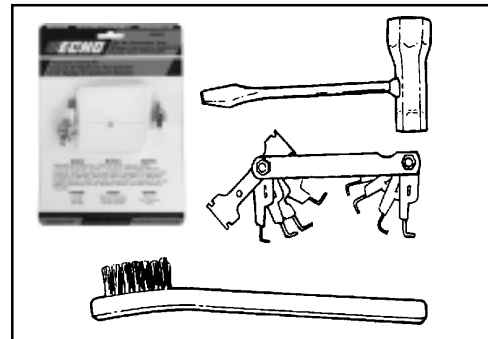

COOLING SYSTEMS CLEANING

Level 2.

Tools required: Cross Head Screwdriver, 4 mm Hex Wrench, Cleaning Brush, 25 or 50 mm (1 or 2 in.) medium bristle paint brush.

Parts Required: None if you are careful.

IMPORTANT

To maintain proper engine operating temperatures, cooling air must pass freely through the cylinder fin area. This flow of air carries combustion heat away from the engine.

Overheating and engine seizure can occur when:

- Air intakes are blocked, preventing cooling air from reaching the cylinder.
- Dust and grass build up on the outside of the cylinder. This build up insulates the engine and prevents the heat from leaving.

Removal of cooling passage blockages or cleaning of cooling fins is considered "Normal Maintenance". Any failure attributed to lack of maintenance is not warranted.

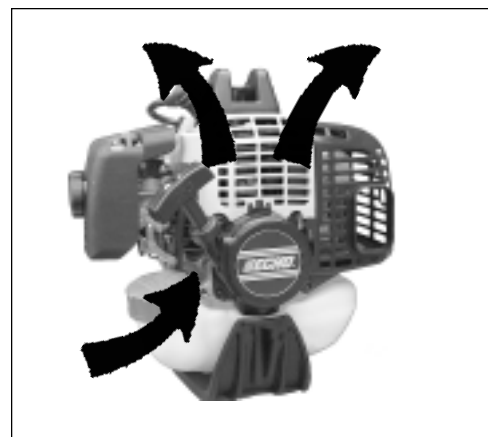
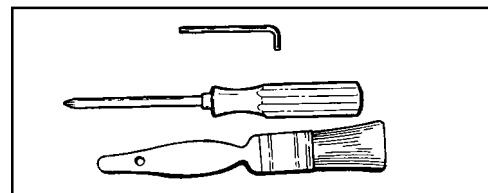

1. Remove spark plug lead.
2. Remove two (2) muffler cover screws and muffler cover (A).
3. Remove screw and arm rest (B).
4. Remove cylinder cover (C).

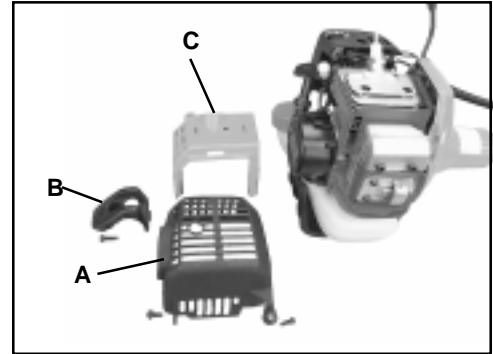

IMPORTANT

DO NOT use a metal scraper to remove dirt from the cylinder fins.

5. Use brush to remove dirt from the cylinder fins.
6. Remove grass and leaves from the grid between the recoil starter and fuel tank.

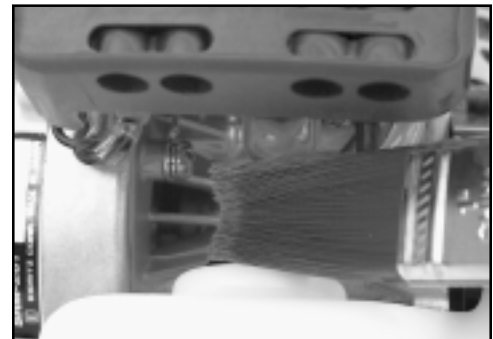

EXHAUST SYSTEM

Spark Arrester Screen

Level 2.

Tools Required: Cross Head Screwdriver, 4mm Hex Wrench, Soft Metal Brush

Parts Required: Spark Arrester Screen P/N 14586251030.

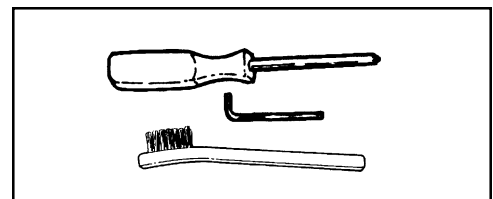

1. Remove two (2) muffler cover screws and muffler cover (A).
2. Place piston at Top Dead Center (TDC) to prevent carbon/dirt from entering cylinder.
3. Remove spark arrestor screen cover (B), gasket (C), gasket (D) and screen (E) from muffler body.
4. Clean carbon deposits from screen and muffler components.

NOTE

When cleaning carbon deposit, be careful not to damage the catalytic body.

5. Replace screen if it is cracked, plugged or has holes burned through.
6. Assemble components in reverse order.

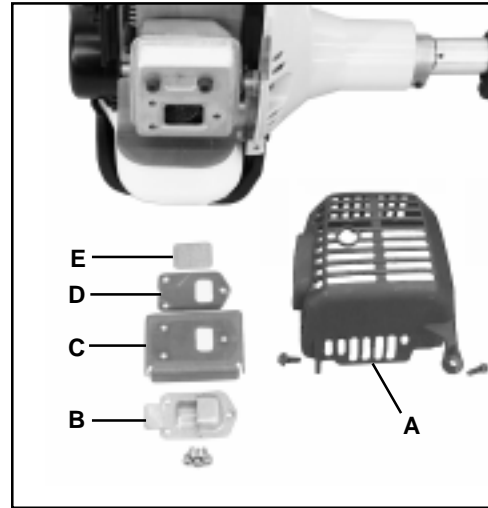

Cylinder Exhaust Port

Level 3.

IMPORTANT

The cylinder exhaust port must be inspected and cleaned of excess carbon every 3 months or 90 hours of operation in order to maintain this engine within the emissions durability period. ECHO strongly recommends that you return your unit to your ECHO dealer for this important maintenance service.

CARBURETOR ADJUSTMENT

Engine Break-In

New engines must be operated a minimum duration of two tanks of fuel break-in before carburetor adjustments can be made. During the break-in period your engine performance will increase and exhaust emissions will stabilize. Idle speed can be adjusted as required.

High Altitude Adjustment

High altitude adjustment is not required for proper operation of this engine.



Level 2.

Tools required: Screwdriver, Tachometer (ECHO P/N 99051130017).

Parts required: None.

NOTE

Every unit is run at the factory and the carburetor is set in compliance with California Emission Regulations. This carburetor does not have acceleration and high speed adjustment needles.

1. Check idle speed and reset if necessary. If a tachometer is available, idle speed screw (A) should be set to the specifications found on page 13 "Specifications" of this manual. Turn idle screw (A) clockwise to increase idle speed; counter clockwise to decrease idle speed.

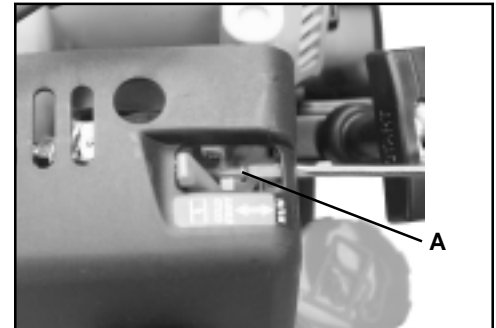
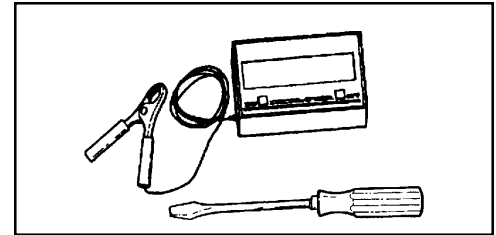

WARNING DANGER

When carburetor adjustment is completed, the blades should not move at idle, otherwise serious personal injury may result.

LUBRICATION

Blades

Level 1.

Tools Required: Clean Rag, Brush, Oil Can, (2) 10 mm wrenches.

Parts Required: 20W Engine Oil (lubrication), 50-50 mixture of kerosene and 20W oil (cleaning).

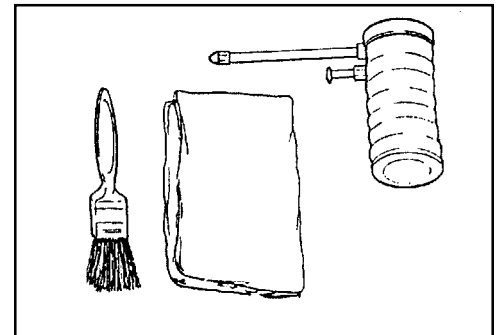

WARNING DANGER

Always disconnect spark plug wire before servicing cutting attachment. Blades are very sharp. Wear gloves to protect hands, otherwise serious personal injury may result.

1. Brush loose debris from blade and coat both sides of blade with the 50-50 cleaning mixture.
2. Allow cleaning mixture to soften the remaining gummy residue then wipe it from the blade.
3. Apply clean oil to the entire length of the blade. Be certain the blade bolts are lubricated.

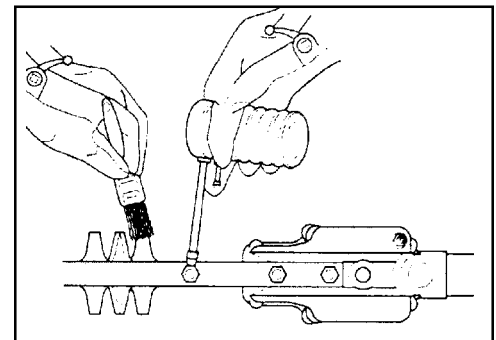

4. Wipe excess oil from the blade before putting the unit back in service.
5. Check blade tightness. Tighten blade bolts (A) until snug with 10 mm wrench. Loosen bolts 1/2 turn. Hold bolts (A) from turning and tighten locknuts (B) with other 10 mm wrench.

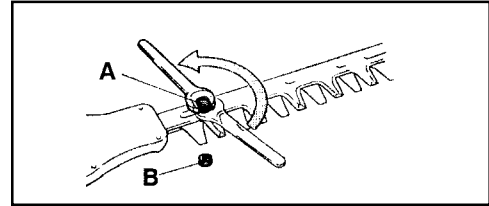

Gear Housing Assembly

Level 2

Tools required: Grease Gun with Echo Lube™ 14 oz. cartridge P/N 91015 or Lithium Grease, Rag.

Parts required: Lithium Based Grease.

1. Clean dirt from grease fittings.
2. Carefully pump grease in each fitting. **DO NOT** force grease. Too much pressure will force grease past seals and cause damage. Apply 1-2 pumps of grease every 15-25 hours of operation.

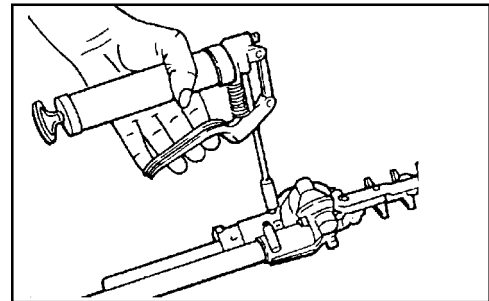

Drive Shaft Assembly

Level 1

NOTE

Hedge Clipper drive shaft should be greased every 25 hours of operation.

Tools required: 8MM Open End Wrench, Screwdriver, Clean Rag, Small Brush.

Parts required: Echo Lube™ 14 oz. cartridge P/N 91015 or Lithium Based Grease.

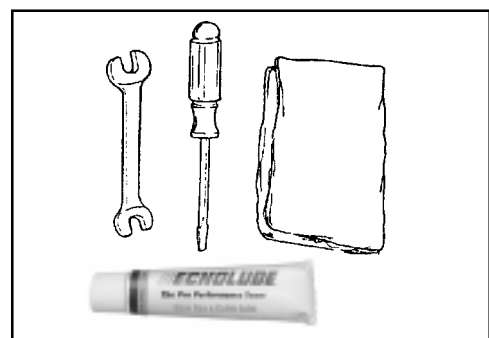

WARNING DANGER

Blades are very sharp. Wear gloves to protect hands, otherwise serious personal injury may result.

1. Loosen gear housing locating screw (A) and mounting screws (C). Remove the gear housing assembly from the drive shaft housing.

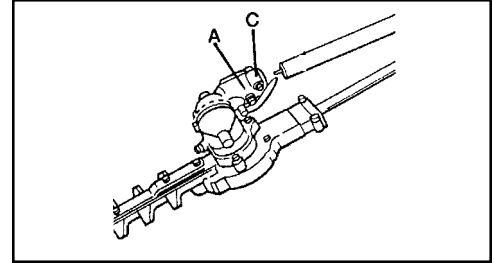

2. Pull the drive shaft (B) from the housing, wipe clean and re-coat with a thin coating [1/2 oz. (15 ml)] of grease.
3. Slide the flexible shaft back in the drive housing being careful not to get dirt on the flex shaft.
4. Install the gear housing assembly.

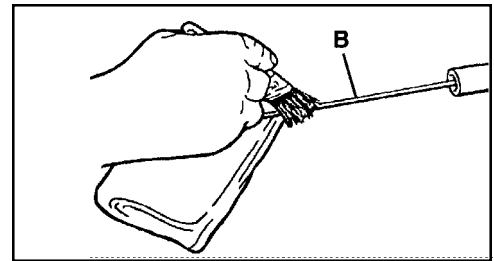

SHARPENING BLADES

Level 2.

Tools required: Flat file, Small Screwdriver

Parts required: None

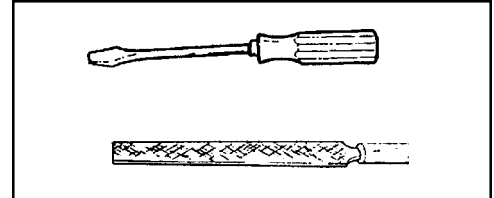

WARNING **DANGER**

Always disconnect spark plug wire before servicing cutting attachment. Blades are very sharp. Wear gloves to protect hands, otherwise serious personal injury may result.

1. Use screwdriver to separate upper and lower cutters equal distance apart.
2. File each edge carefully. Follow the original shape of the blade.

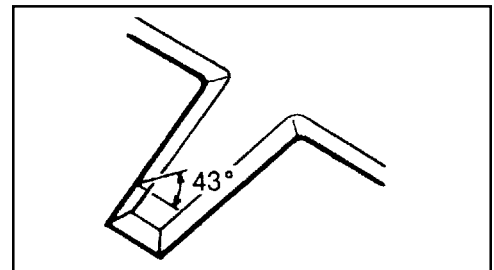

IMPORTANT

If a power grinder is used **DO NOT** allow blade to over heat.

3. Lubricate blades. See "Blade Lubrication Instructions", page 27 this section.

TROUBLESHOOTING

Problem			Cause
Engine -- starts hard			
Engine -- does not start			
Engine Cranks	Fuel at carburetor	No fuel at carburetor	Fuel strain Fuel line cl Carburetor
	Fuel at cylinder	No fuel at cylinder	Carburetor
		Muffler wet with fuel	Fuel Mixtur
	Spark at end of plug wire	No spark at end of plug wire	Stop switcl Electrical p Interlock sv
	Spark at plug	No spark at plug	Spark gap Covered w Fouled witt Spark plug
Engine does not crank		Internal eng	

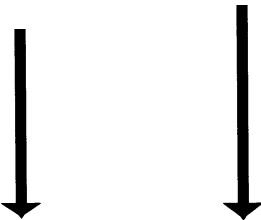

WARNING DANGER

Fuel vapors are **extremely** flammable and may cause fire and/or explosion. **Never** test for ignition spark near an open spark plug opening, otherwise serious personal injury may result.

STORAGE

WARNING  **DANGER**

During operation the muffler or catalytic muffler and surrounding cover become hot. Always keep exhaust area clear of flammable debris during transportation or when storing, otherwise serious property damage or personal injury may result.

Long Term Storage (over 30 days)

Do not store your unit for a prolonged period of time (30 days or longer) without performing protective storage maintenance which includes the following:

1. Store unit in a dry, dust free place, out of the reach of children.

WARNING  **DANGER**

Do not store in enclosure where fuel fumes may accumulate or reach an open flame or spark or serious personal injury may result.

2. Place the stop switch (A) in the "OFF" position.
3. Remove accumulation of grease, oil, dirt and debris from exterior of unit.
4. Perform all periodic lubrication and services that are required.
5. Tighten all the screws and nuts.
6. **Drain** the fuel tank **completely** and pull the recoil starter handle several times to remove fuel from the carburetor.
7. Remove the spark plug and pour 7 cc (1/4 oz.; 1/2 tablespoon) of fresh, clean, two-stroke engine oil into the cylinder through the spark plug hole.
 - A. Place a clean cloth over the spark plug hole.
 - B. Pull the recoil starter handle 2-3 times to distribute the oil inside the engine.
 - C. Observe the piston location through the spark plug hole. Pull the recoil handle slowly until the piston reaches the top of its travel and leave it there.
8. Install the spark plug (do not connect spark plug cable).
9. Install blade cover on blades.

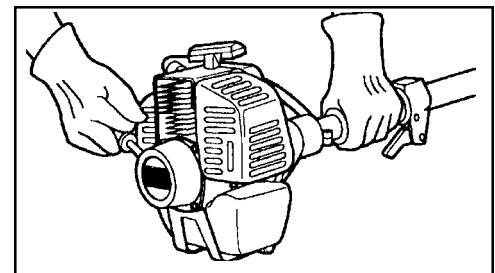
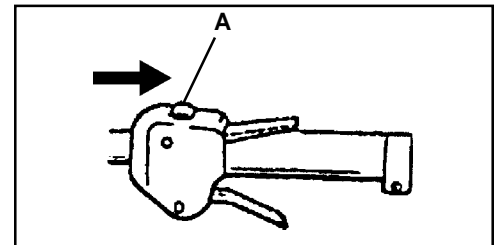

SERVICING INFORMATION

PARTS

Genuine ECHO Parts and ECHO REPOWER™ Parts and Assemblies for your ECHO products are available only from an Authorized ECHO Dealer. When you do need to buy parts **always** have the Model Number and Serial Number of the unit with you. You can find these numbers on the engine housing. For future reference, write them in the space provided below.

Model No. _____ SN. _____

SERVICE

Service of this product during the warranty period must be performed by an Authorized ECHO Service Dealer. For the name and address of the Authorized ECHO Service Dealer nearest you, ask your retailer or call: 1-800-432-ECHO (3246). When presenting your unit for Warranty service/repairs, proof of purchase is required.

ECHO CONSUMER PRODUCT SUPPORT

If you require assistance or have questions concerning the application, operation or maintenance of this product you may call the ECHO Consumer Product Support Department at 1-800-673-1558 from 8:00 am to 5:00 pm (Central Standard Time) Monday through Friday. Before calling, please know the model and serial number of your unit to help your Consumer Product Support Representative.

WARRANTY CARD

This card is our means of registering all original owners of ECHO equipment. The card plus proof of purchase provides you the assurance that authorized warranty work will be done. It also provides a direct link between you and ECHO if we find it necessary to contact you.

ADDITIONAL OR REPLACEMENT MANUALS

Safety Manuals P/N 89857020060 are available, free of charge, from your ECHO dealer or by contacting Echo Incorporated, 400 Oakwood Road, Lake Zurich, IL 60047.

Operator's and Parts Manuals are available for purchase from your ECHO dealer or directly from ECHO. [See ordering instructions below.]

Safety Video is available from you dealer. A \$5.00 shipping charge will be required.

ORDERING INSTRUCTIONS

To obtain a Parts Catalog or Operator's Manual send a check or money order for \$2.00 per Parts Catalog or \$1.50 per Operator's Manual made payable to ECHO, INCORPORATED. State on a sheet of paper the model number and serial number of the ECHO unit you have, part number of the manual (if known), your name and address and mail to address above.

Available Parts Catalog

HCA-261 S/N 001001 & Up Part Number 99922203176

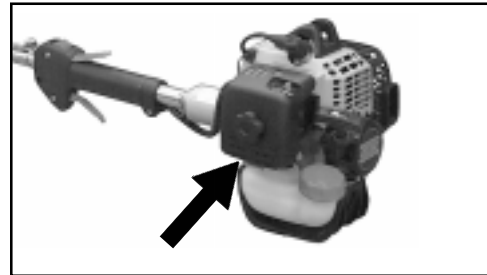

DEALER?

Call

1-800-432-ECHO

**CONSUMER PRODUCT
SUPPORT**

1-800-673-1558

8 - 5 Mon - Fri C.S.T.

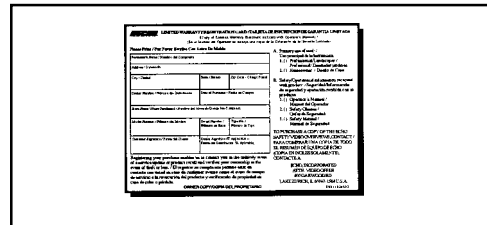

ECHO, Incorporated

400 Oakwood Road

Lake Zurich, IL 60047

Technical Publications Orders

ECHO®

ECHO, INCORPORATED

400 OAKWOOD ROAD

LAKE ZURICH, IL 60047 U.S.A.



SUPPLEMENT TO OPERATOR'S MANUAL
PART NUMBER 89861112351 (X7502248801)
FOR MODEL: HCA-2400
PART NUMBER X750000680 (X7502092700)
FOR MODEL: HCA-260
PART NUMBER X750001220 (X7502094700)
FOR MODEL: HCA-261

SUPLEMENTO DEL MANUAL DEL OPERADOR
NÚMERO DE PIEZA 89861112351 (X7502248801)
PARA LOS MODELO: HCA-2400
NÚMERO DE PIEZA X750000680 (X7502092700)
PARA LOS MODELO: HCA-260
NÚMERO DE PIEZA X750001220 (X7502094700)
PARA LOS MODELO: HCA-261

SUPPLÉMENT AU MANUEL DE L'OPÉRATEUR
RÉFÉRENCE 89862512362 (X7502247702)
POUR MODÈLE : HCA-2400

ASSEMBLY FRONT (LOOP) HANDLE INSTALLATION

IMPORTANT

Always store and transport shaft hedge clippers in a stable, horizontal position. Support gear case and cutting blades to prevent excessive flexing which may cause damage to the cutting attachment. Always install blade cover when transporting or storing unit.

Tools Required: Screwdriver

Parts Required: Front (Loop) Handle Assembly

1. Install front handle on drive shaft, do not tighten screws yet.
2. Position front handle for comfortable operation and secure screws.



MONTAJE

INSTALACION DE LA EMPUÑADURA DELANTERA

IMPORTANTE

Guarde y transporte siempre los cortasetos de eje en una posición horizontal estable. Soporte la caja de engranajes y las hojas de corte para impedir una flexión excesiva que puede causar daños en el accesorio de corte. Instale siempre la tapa de la hoja al transportar o guardar la unidad.

Herramientas necesarias: destornillador.

Piezas necesarias: conjunto de empuñadura delantera

1. Coloque la empuñadura delantera en el eje de impulsión, NO apriete aún los tornillos.
2. Coloque la empuñadura delantera para una operación cómoda y sujete los tornillos.

MONTAGE

INSTALLATION DE LA POIGNÉE AVANT

IMPORTANT

Toujours remiser les taille-haies à arbre dans une position stable, à l'horizontale. Soutenir le carter d'engrenages et les lames de coupe de manière à éviter un fléchissement excessif qui pourrait endommager d'accessoire. Toujours installer le protection de lame avant le transport ou le remisage.

Outils nécessaires : Tournevis

Pièces nécessaires : Poignée avant

1. Mettre la poignée avant sur une position confortable et serrer les vis.

SUPP22203392

**99922203392
07/01**

Free Manuals Download Website

<http://myh66.com>

<http://usermanuals.us>

<http://www.somanuals.com>

<http://www.4manuals.cc>

<http://www.manual-lib.com>

<http://www.404manual.com>

<http://www.luxmanual.com>

<http://aubethermostatmanual.com>

Golf course search by state

<http://golfingnear.com>

Email search by domain

<http://emailbydomain.com>

Auto manuals search

<http://auto.somanuals.com>

TV manuals search

<http://tv.somanuals.com>