

# **ECHO**®

# **Backpack Sprayer**

**Use and Care  
Manual**



**Model MS-40BP  
4.0G/15.1L**

**⚠ WARNING!**

**Carefully Read These Instructions Before Use**

011289 R0211

## **WARNING!**

**IMPROPER USE OR FAILURE TO FOLLOW INSTRUCTIONS CAN RESULT IN PRODUCT FAILURE OR INJURIES. FOR SAFE USE OF THIS PRODUCT YOU MUST READ AND FOLLOW ALL INSTRUCTIONS BEFORE USING.**

**WARNING:** Handling the brass parts of this product will expose you to lead, a chemical known to the State of California to cause birth defects and other reproductive harm.

***Wash hands after handling.***

## **CAUTION**

### **RULES FOR SAFE OPERATION**

**Before assembling and operating your sprayer, read all instructions thoroughly. When working with equipment under pressure, safety precautions must always be carefully observed, including the following:**

- **NEVER spray flammable materials or pressure and gas producing chemicals.**
- **ALWAYS read chemical label before filling sprayer as some chemicals may be hazardous when used with this sprayer.**
- **ALWAYS wear goggles, gloves, a long-sleeve shirt, long pants, and full foot protection when spraying. Work in a ventilated area or outdoors.**
- **PRE-USE CHECK:** Before each use check tightness of hose nut to be sure hose is securely attached to the shut-off assembly. Insure hose is securely attached to the tank by tightening hose clamp if necessary. Insure that all nozzle and wand connections are tight. Insure the large pump clamp is tight. Insure the 2 bolts used to attach the pump lever to the pump shaft are tight.
- **DO NOT** leave a pressurized sprayer in the hot sun or anywhere near a heat source. Heat can produce pressure to build up causing sprayer to ignite or explode resulting in injury or death.
- **NEVER** pressurize sprayer by any means other than the original pump. Over pressurizing can cause sprayer to explode resulting in injury or death.
- **DO NOT** attempt to modify or repair this product except with original manufacturer's parts.

**NOTE: The tank and hose may have residual water in it due to quality testing performed on the sprayer.**

## APPLICATIONS & USE FOR YOUR SPRAYER

Avoid using a sprayer for general cleaning purposes if plant protection or herbicide chemicals have already been used in the sprayer. If a sprayer has been used for plant protection or as an herbicide, clean the sprayer completely (see cleaning section) before using.

**Plant Food:** Use different spray patterns for optimum foliage feeding or for fungicide and pesticide application.

**Herbicides:** Reduce weeds and unwanted plants but avoid using the same sprayer for plant feeding or protection without thoroughly cleaning (see cleaning section) the sprayer first.

**General Household Use:** Apply detergents, vinegar, cleaning solutions, warm water (do not exceed 120°F/49°C) or nontoxic household cleaning chemicals for carpets, floors, walls, glass, counter tops and ceilings. DO NOT use sprayer that has been used with herbicides, pesticides or other toxic chemicals for household applications.

**General Outdoor Use:** Use the sprayer for cleaning windows or with a detergent for general purpose cleaning. Other applications include wood preservatives, waxes, water proofing, and diluted household bleach (max. 1 part household bleach to 9 parts water solution).

## SPRAYER COMPONENTS & USE INFORMATION

### NOZZLE ASSEMBLY

#### Figure 1-2

Unscrew the nozzle cap (1) from the nozzle body (3) with retaining nut (2) fastened tightly to the elbow (5). Unscrew the retaining nut (2). Push the nozzle body (3) with the nozzle gasket (4) out of the retaining nut (2). To reinstall the nozzle, reverse the above instructions.

#### Figure 3

Unscrew the retaining nut from the elbow and push the fan nozzle tip and gasket out of the retaining nut. To reinstall the nozzle, reverse the above instructions.

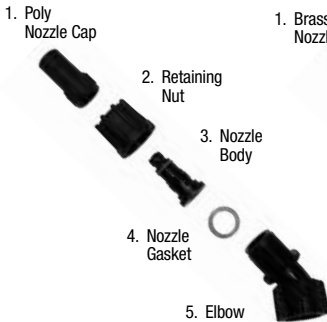

Figure 1

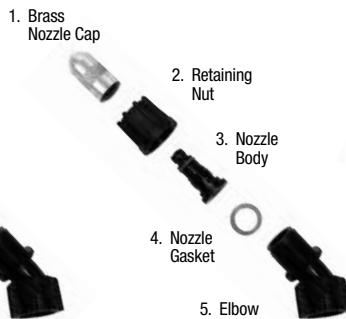

Figure 2



Figure 3

### WAND ASSEMBLY

1. Make sure the o-ring is installed on the end of the wand.  
Insert the wand into shut-off valve.
2. Turn and tighten the retaining nut clock-wise onto the shut-off valve.



## SPRAYER COMPONENTS & USE INFORMATION, Continued

### INSTALLING THE PUMP HANDLE

The pump handle can be mounted on either side of the pump shaft (A). To install the pump handle place the handle (C) over the shaft (A) aligning the pump handle hole and shaft hole. Push the straight side of the cotter pin (B) through the aligned hole as shown in figure 1 thru 3. There are holes in the pump handle to allow for either left (fig.4) or right (fig.5) hand mounting.

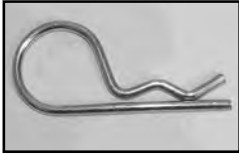
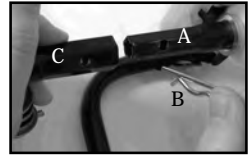

Figure 1  
Cotter Pin



Figure 2  
Line up holes



Figure 3  
Slide pin through holes.



Figure 4  
Left Hand



Figure 5  
Right Hand



### STOWAWAY PUMP HANDLE

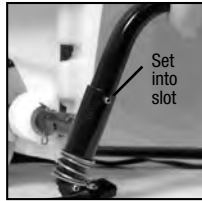
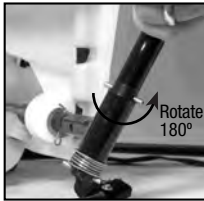
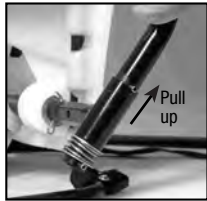

### INSTALLING THE SHOULDER STRAP

The top of the shoulder straps are attached to the tank. Attach the lower end of the straps by clipping the strap hooks to the metal frame between where the frame exits the tank and curves around.

NOTE: If your straps become contaminated with dirt or chemicals, wash with mild soap and water and let dry overnight. If this does not remove the contamination, replace with new straps.



### WAND CLIP

The wand can be attached to the pump handle using the wand clip.



## SPRAYER COMPONENTS & USE INFORMATION, Continued

### 4 STAGE FILTERING SYSTEM

This backpack sprayer is equipped with a 4 stage filtering system (see figure 1). Stage 1 is a filter basket incorporated into the tank opening where fluid is added. Stage 2 and 3 filters are located at the inlet of the pressure cylinder. Stage 2 is a removable In-Tank filter. Stage 3 is a removable filter cartridge integrated into the pressure cylinder. Stage 4 is a removable filter incorporated into the shut-off assembly. Periodic cleaning of these filters is recommended to insure consistent fluid flow through the sprayer. This will also reduce sprayer component wear.

Stage 3 filter cartridge cleaning requires removal of the entire pressure cylinder assembly (see section "disassembling and repairing the pressure cylinder"). Once the pressure cylinder is removed the stage 3 filter can be removed for cleaning (see figure 3). Periodic cleaning of the stage 2 filter is highly recommended and will reduce the need to perform this disassembly. It is best to have no or minimal fluid in the tank before removing and reinstalling the stage 2 In-Tank filter. The In-Tank filter needs to be oriented in a specific way when inserted into the pressure cylinder base (see figure 2).

The stage 4 filter is a removable filter incorporated into the inlet side of the shut-off valve (see section "disassembling and repairing the shut-off valve"). Make sure pressure is released before detaching the hose from the shut-off. It is best to have no or minimal fluid in the pressure cylinder before removing and reinstalling the stage 4 shut-off filter as fluid can leak from the hose.

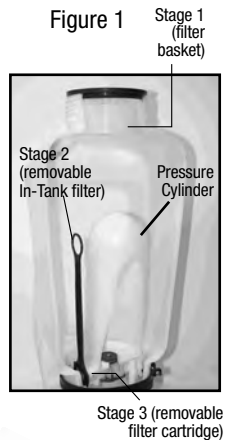
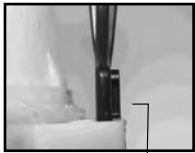

Figure 2 Stage 2 (removable In-Tank filter)



Guide edge facing away from pressure cylinder



Guide edge on pressure cylinder

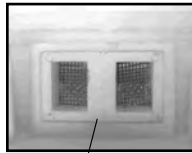

Filter cartridge in pressure cylinder base

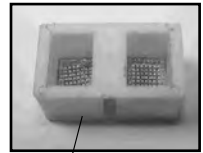

Filter cartridge removed

Figure 3 Stage 3 (removable filter cartridge)

### FILLING THE SPRAYER

Make sure the filter basket is in place to keep debris from entering the tank.

Determine the amount of mixture needed for your application. Add the proper amount of water to the tank. Add the proper amount of chemical to the tank (check the chemical label for proper ratio of chemical). Stir mixture in tank with a clean utensil (like a paint stirrer). The tank will hold the 4-gallon (15.1L) capacity plus the chemical.

It is not necessary to completely fill the sprayer tank with each use. You can fill the tank with only the amount needed for each application.

Always follow the manufacturer's instructions included on their product label.

## SPRAYER COMPONENTS & USE INFORMATION, Continued

### HELPFUL SPRAYING INFORMATION

Use RAPID pump strokes to prime the pump. You will know the pressure chamber is filling with liquid when you feel firm resistance from the pump. The air in the pressure chamber is compressed from repeated strokes. By pressing the hand lever on the shut-off, the valve opens. For safety lock-off feature (no-spraying), pull up on handle and move red locking mechanism into lock-off position as shown in fig. 1. To disengage, push down on handle and return red locking mechanism to neutral position as in fig. 3. For lock-on feature (continuous spraying), push down on handle and move red locking mechanism into lock-on position as shown in fig. 2. To disengage, push down on handle and return red locking mechanism to neutral position as shown in fig. 3.

If the shut-off fails, place wand into tank until pressure is completely exhausted.

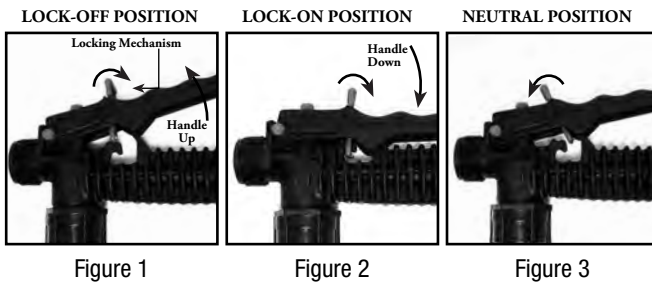

For easy pump action use the END of the pump handle. The amount of liquid delivered during spraying depends on the rate of pump stroke. The fan nozzle tip is rated at .4 gpm at 40psi. This is the nominal operating pressure of the sprayer.

**Note:** If you experience a rapid drop in pressure, drain the sprayer completely and pump the handle with an empty tank. The pressure chamber will fill with the required volume of air to repressurize. Perform this procedure from time to time as routine maintenance.

### POWDER-BASED CHEMICALS

Powder-based chemicals (powder mixed with liquids to make the spraying agent) are usually abrasive and can cause wear. When you use a powder-based chemical in your sprayer, make sure it is thoroughly dissolved in the liquid solution. Thoroughly clean and flush the sprayer with water to extend the life of the sprayers parts.

### CLEANING

- 1) Always empty the sprayer and clean the tank thoroughly after each use.
- 2) Pump the sprayer handle until all of the contents and air exit through the nozzle (minimum of 30 strokes).
- 3) Fill tank half way with water and pump the water out as explained in step 2 (repeat several times as necessary).

### Other Cleaning Hints:

- Improper spray distribution usually means the nozzle is clogged, remove the nozzle and clean it.
- Soap can be added to the water to clean the tank.
- Do not use strong cleaning agents or abrasives.
- If you use a chemical agent to clean the tank follow the manufacturer's recommendations for the disposal of the waste water.
- Follow the chemical manufacturers instructions for clean up.

## STORING / MAINTAINING YOUR SPRAYER

- The sprayer should be stored out of direct sunlight in a cool dry space.
- Before freezing weather make sure to drain all liquid in the tank, pump, pressure cylinder, hose, shut-off valve, wand and nozzle, to avoid liquid expansion and cracking in the sprayer components (See "Cleaning" section). Lock the shut-off valve in the "open" position.
- When service is required call your nearest dealer and always insist on original manufactured replacement parts.
- Inspect the hose, wand, pump, tank and shut-off valve for wear, damage or leaks on a regular basis and repair defects promptly.

## TROUBLE SHOOTING YOUR SPRAYER

Symptom	Possible Reason	Correction
Difficulty actuating the pump handle and/or pump handle moves itself back up.	Upper valve plate sticks	Clean or replace valve plate
	Piston cylinder outlet passage clogged	Clean piston cylinder outlet passage
Little or no resistance during repeated pumping – no pressure.	Damaged/worn/dirty/upper valve plate	Clean or Replace Valve Plate
	Damaged /worn upper o-ring on piston cylinder	Replace O-ring
	Piston Collar or piston cylinder assembly is worn	Replace Collar or Piston cylinder assembly
Too much resistance after just a few pumping strokes but pressure only lasts briefly.	Not enough air cushion in the pressure chamber	Release pressure in pressure chamber Remove the hose & drain pressure chamber. Reconnect the hose.
	Upper valve plate damaged/worn/dirty	Clean or replace upper valve plate
Upward pumping action is more difficult and/or pump handle moves itself backdown.	Vent hole is clogged	Clear the vent hole in cap
	Lower valve plate sticks	Clean or replace the valve plate
	Clogged intake filter	Clean the In-Tank filter and/or removable cartridge filter
	Piston cylinder intake clogged	Clean piston cylinder intake
Leaks at Piston Cylinder	Damaged/worn/Dirty Collar	Clean or Replace Piston Collar
	Damaged Piston Cylinder	Replace Piston Cylinder
	Damaged Piston	Replace Piston
Shut-off leaks	Connections loose	Tighten connection
	Worn or damaged shut-off	Rebuild or replace the shut-off valve
Wand assembly leaks	Connections loose	Tighten connection
	Damaged or worn o-ring/gasket	Replace o-ring/gasket
Nozzle assembly leaks	Connections loose	Tighten connection
	Damaged or worn o-ring/gasket	Replace o-ring/gasket
Leak between pump assembly and tank	Pump clamp loose	Tighten clamp
	O-ring worn or damaged	Replace pressure chamber oring
Hose leaking at tank outlet	Hose clamp loose	Tighten clamp
Hose leaking at shut-off	Connection loose	Tighten retaining nut
	Damaged or worn o-ring/gasket	Replace o-ring/gasket

## DISASSEMBLING AND REPAIRING THE PISTON PUMP

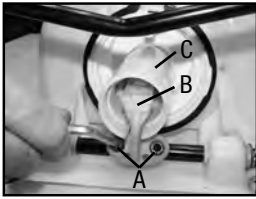

Figure 1

1) Remove the cotter pin and pump handle. With the pump facing towards you, lay the unit on its back (Figure 1). Loosen the hose clamp and remove the sprayer hose. Caution: There could be residual liquid in the hose and pressure cylinder. Remove the nut and bolt from the protective cap and remove the cap (ref: figure 9). Rotate the pump shaft in order to reach two lever bolts (A). Using an allen wrench, remove the lever bolts. Pull the piston assembly (B) out of the piston cylinder (C).



Figure 2

2) Remove the piston cylinder assembly by turning the piston cylinder counter-clockwise when viewing the sprayer from the bottom. Caution: The piston cylinder may have sharp edges.



Figure 3

3) Check for vertical scratches on the inside of the piston cylinder and the piston. If one or both are scratched, replace them.



Figure 4

4) To replace the collar, push it off of the crown of the piston with your thumb. You will see form fitted slots to install the new collar on to the piston crown.

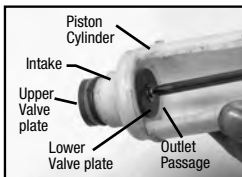

Figure 5

5) There are 2 valve plates on the piston cylinder, one on the inside of the cylinder and one on the outside top. The valve plates are held in place with a screw and washer and can be removed and replaced using a Phillipshead screw driver. The 2 o-rings can be removed and replaced as well. Insure that the o-rings are positioned in the o-ring grooves in the piston cylinder.

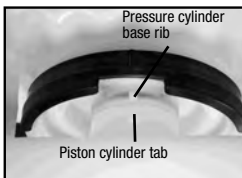

Figure 6

6) Grease the 2 O-rings on the piston cylinder (do not get any grease on the valve plate) and screw the piston assembly into the pressure cylinder base. Screw the piston cylinder clockwise until tight and the bottom O-ring is no longer visible. When properly placed, the tab on the piston cylinder will line up with the rib on the pressure cylinder base.





Figure 7

7) Apply Petroleum jelly to the inside of the piston cylinder wall and on the collar, and reinstall the piston assembly into the piston cylinder.



Figure 8

8) Insert the piston at an angle with the leading edge of the collar placed over the slot in the piston cylinder. Bolt the piston assembly to the pump shaft using the lever bolts.



Figure 9

9) Replace the protective dust cap. Tighten the nut and bolt. Reinstall the pump handle. Replace the hose and firmly secure the hose clamp in place.

## DISASSEMBLING AND REPAIRING THE PUMP ASSEMBLY

**Only remove the pump assembly if the cartridge filter is clogged or the sprayer is leaking between the pressure chamber o-ring and tank.**

1. Release the pressure from the sprayer and remove all liquid from both the pressure chamber and tank.
2. Remove hose.
3. Remove the In-tank filter from the pressure cylinder (located inside the tank - fig. 1).
4. Remove 2 bolts attaching the pivot lever to the pump shaft and remove piston assembly (fig. 2a & 2b).
5. Remove the large clamp holding the pressure chamber and tank together (fig 1).
6. Rock the pressure chamber back and forth and push down to free it from the tank (fig 1).
7. Once freed the entire pump assembly can be removed by maneuvering it through the base frame (fig 3a & 3b).

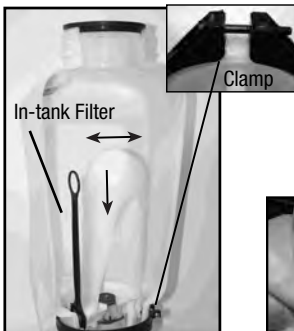

Figure 1



Figure 2a



Figure 2b



Figure 3a

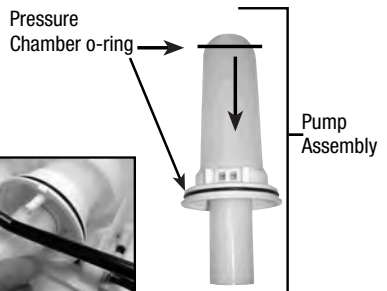

Figure 3b

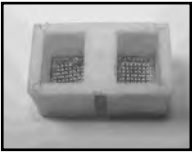

Figure 4

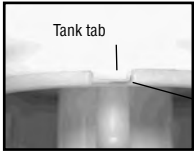

Figure 5

8. At this point the filter cartridge in the pressure chamber base can be removed with pliers and cleaned (fig 4).
9. The pressure chamber o-ring can also be replaced. DO NOT stretch the o-ring over the bottom flange. Assemble the o-ring over the top of the chamber. Apply petroleum jelly to the o-ring before reinstalling pump assembly into the tank (fig. 3b).
10. Reassemble backwards from step 7 thru 2, performing each step in reverse. Note: there is a notch/tab combination in the pump assembly/tank to be used for alignment (fig. 5).

## DISASSEMBLING AND REPAIRING THE SHUT OFF VALVE



Figure 1

- 1) Assembled shut-off valve (Figure 1).



A

Figure 2

- 2) Remove the retaining pin (A) (Figure 2) place the notched end of the retaining pin on a hard surface and push down. Remove the retaining pin and slide the handle off the valve stem.

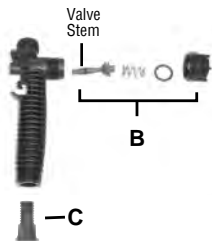
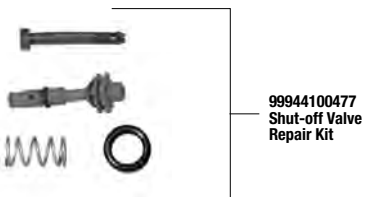
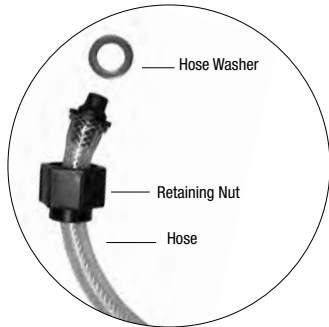
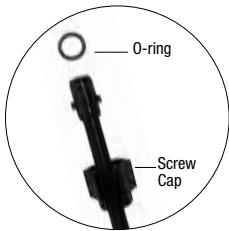
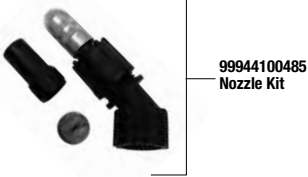

Figure 3

- 3) Remove the retaining nut (o-ring attached), spring, and valve stem (B) (Figure 3). Replace worn parts. Lubricate the O-rings and reassemble by reversing the steps above. Place the handle groove in the slotted area of the valve stem and make sure the locking clip is positioned in the neutral position (see "Helpful Spraying Information" section). Insert the retaining pin. Push down on the handle a few times to distribute the lubricant evenly. Check filter (C) in end of shut-off valve for debris. Remove filter and flush with water to clean out.

# REPLACEMENT PARTS ORDER INFORMATION

## NOZZLE ASSEMBLY



# REPLACEMENT PARTS ORDER INFORMATION

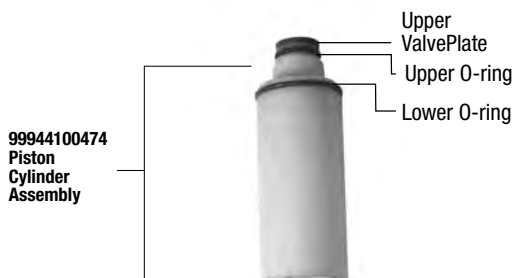

99944100471  
Piston Pump Repair Kit

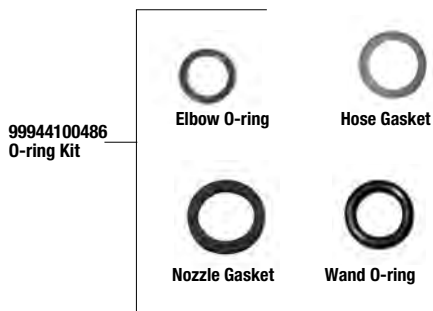
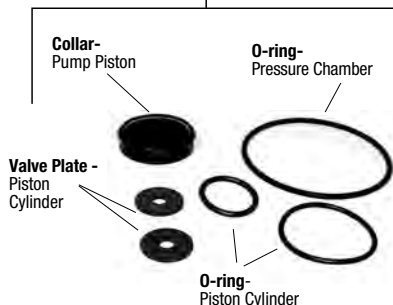

99944100473  
Filter Basket &  
Cap



99944100488  
Wand Clips



ECHO, INCORPORATED  
400 Oakwood Road, Lake Zurich, IL 60047  
www.echo-usa.com

**ECHO LIMITED WARRANTY STATEMENT FOR  
SPRAYERS SOLD IN USA AND CANADA BEGINNING 01/01/2010**

**ECHO'S RESPONSIBILITY**

ECHO Incorporated's Limited Warranty, provides to the original end user purchaser that this ECHO product is free from defects in material and workmanship. Under normal use and maintenance from date of purchase, ECHO agrees to repair or replace at ECHO's discretion, any defective product free of charge at any authorized ECHO servicing dealer within listed below application time periods, limitations and exclusions. **THIS LIMITED WARRANTY IS ONLY APPLICABLE TO ECHO PRODUCTS SOLD BY AUTHORIZED ECHO DEALERS. IT IS EXTENDED TO THE ORIGINAL END USER PURCHASER ONLY, AND IS NOT TRANSFERABLE TO SUBSEQUENT OWNERS.** Repair parts and accessories replaced under this warranty are warranted only for the balance of the original unit or accessory warranty period. Any damage caused by improper use, modifications, installation or maintenance is not covered by this warranty. All parts or products replaced under warranty become the property of ECHO, Inc. For a list of Authorized ECHO Dealers refer to WWW.ECHO-USA.COM or call **1-800-432-Echo**.

**OWNER'S RESPONSIBILITY**

To ensure trouble free warranty coverage it is important that you register your Echo equipment on-line at WWW.ECHO-USA.COM or by filling out the warranty registration card supplied with your unit. Registering your product confirms your warranty coverage and provides a direct link if we find it necessary to contact you. The owner shall demonstrate reasonable care and use, and follow preventative maintenance and storage Instructions, as prescribed in the Use & Care Manual. Should a product difficulty occur, you must, at your expense, deliver or ship your ECHO unit to an authorized ECHO servicing dealer for warranty repairs (within the applicable warranty period), and arrange for pick-up or return of your unit after the repairs have been made. For your nearest authorized ECHO servicing dealer, call ECHO's Dealer Referral Center, at 1-800-432-ECHO or you can locate an ECHO servicing dealer at WWW.ECHO-USA.COM. Should you require assistance or have questions concerning ECHO's Warranty Statement, you can contact our Consumer Product Support Department at 1-800-432-ECHO or contact us through the web at WWW.ECHO-USA.COM.

**PRODUCT WARRANTY PERIOD**

**RESIDENTIAL APPLICATION**

• **5 YEAR WARRANTY** - All units for residential, or non-income producing use will be covered by this limited warranty for five (5) years from date of purchase.

**EXCEPTIONS:**

- Damage caused by:  
Failure to follow Use & Care Manual
- Failure to follow all chemical manufacturers' instructions included on their label or elsewhere
- Failure to follow Storing/Maintaining Your Sprayer section in Use & Care manual

Use of powder based chemicals with or in a piston pump sprayer

Wear items including but not limited to: seals, gaskets, pistons, hoses, diaphragms, straps or any wear item. These items are covered for 90 days from date of purchase.

Any mis-use of product is not covered including but not limited to: using un-approved chemicals or parts, un-approved uses, using damaged or missing units/parts during operation, or modifying your sprayer in any manner.

**COMMERCIAL APPLICATION**

• **2 YEAR WARRANTY** - All units for commercial, institutional, agricultural, industrial, or income producing use will be covered by this limited warranty for two (2) years from the date of purchase.

**EXCEPTIONS:**

- Failure to read and follow Use & Care Manual
- Failure to follow all chemical manufacturers' instructions included on their label or elsewhere
- Failure to follow Storing/Maintaining Your Sprayer section in Use & Care Manual

Use of powder based chemicals with or in a piston pump sprayer

Wear items including but not limited to: seals, gaskets, pistons, hoses, diaphragms, straps or any wear item. These items are covered for 30 days from date of purchase.

Any mis-use of product is not covered including but not limited to: using un-approved chemicals or parts, un-approved uses, using damaged or missing units/parts during operation, or modifying your sprayer in any manner.

**RENTAL APPLICATION - 90 DAYS WARRANTY**

• Units for rental use will be covered against defects in material and workmanship for a period of 90 days from the date of purchase except for any of the above listed EXCEPTIONS.

**PURCHASED REPAIR PARTS AND ACCESSORIES**

90-day residential or non-income producing warranty except for any one of the above listed EXCEPTIONS

• 30-day commercial, institutional, agricultural, industrial, income producing, or rental application warranty except for any one of the above listed EXCEPTIONS

**YOUR RECEIPT OF PURCHASE INCLUDING DATE, MODEL AND SERIAL NUMBER MUST BE MAINTAINED AND PRESENTED TO AN AUTHORIZED ECHO SERVICING DEALER FOR WARRANTY SERVICE. PROOF OF PURCHASE RESTS SOLELY WITH THE CUSTOMER. SOME STATES DO NOT ALLOW LIMITATIONS ON HOW LONG AN IMPLIED WARRANTY LASTS, SO THE ABOVE LIMITATIONS MAY NOT APPLY TO YOU. SOME STATES DO NOT ALLOW THE EXCLUSION OR LIMITATION OF INCIDENTAL OR CONSEQUENTIAL DAMAGES, SO YOU MAY ALSO HAVE OTHER SPECIFIC LEGAL RIGHTS WHICH VARY FROM STATE TO STATE. THIS LIMITED WARRANTY IS GIVEN BY ECHO INCORPORATED, 400 OAKWOOD RD., LAKE ZURICH, IL 60047.**

**DISCLAIMER OF IMPLIED WARRANTIES**

THIS LIMITED WARRANTY IS IN LIEU OF ALL OTHER EXPRESSED OR IMPLIED WARRANTIES, INCLUDING ANY WARRANTY OF FITNESS FOR A PARTICULAR PURPOSE OR USE AND ANY IMPLIED WARRANTY OF MERCHANTABILITY OTHERWISE APPLICABLE TO THIS PRODUCT. ECHO AND ITS AFFILIATED COMPANIES SHALL NOT BE LIABLE FOR ANY SPECIAL INCIDENTAL OR CONSEQUENTIAL DAMAGE, INCLUDING LOST PROFITS. THERE ARE NO WARRANTIES EXTENDED OTHER THAN AS PROVIDED HEREIN. THIS LIMITED WARRANTY MAY BE MODIFIED ONLY BY ECHO.

## Free Manuals Download Website

<http://myh66.com>

<http://usermanuals.us>

<http://www.somanuals.com>

<http://www.4manuals.cc>

<http://www.manual-lib.com>

<http://www.404manual.com>

<http://www.luxmanual.com>

<http://aubethermostatmanual.com>

Golf course search by state

<http://golfingnear.com>

Email search by domain

<http://emailbydomain.com>

Auto manuals search

<http://auto.somanuals.com>

TV manuals search

<http://tv.somanuals.com>