

GRASS/WEED TRIMMER BRUSHCUTTER and CLEARING SAW

SAFETY MANUAL



Read and understand these instructions.
Failure to do so will increase risk of injury.

For your nearest ECHO Dealer, call 1-800-432-ECHO (3246)

X7522270400

99922202600
06/98

GRAPHIC WARNINGS

Specifications, descriptions and illustrative material in this literature are as accurate as known at the time of publication, but are subject to change without notice. Illustrations may include optional equipment and accessories, and may not include all standard equipment.

Circle and slash symbol means whatever is shown is prohibited.

 This device accompanied by the words **WARNING** and **DANGER** calls attention to an act or a condition which can lead to serious personal injury.

RISKS

TO REDUCE RISKS

Eye Loss from Thrown Objects



Wear Eye/Leg Protection (ANSI Z87.1)

Injury to Bystanders

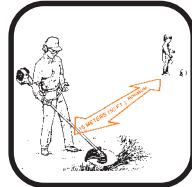

Keep People and Animals Away 15 meters (50 feet)

Injury



Read & Understand Operator's Manual and Safety Manual

Blade Contact from Kick Out (Blade Thrust)



- Read Manuals
- Proper Gear
- Keep People Away

Eye Loss from Ricochet



Wear Eye/Leg Protection (ANSI Z87.1)

Using Wrong Equipment



Blade Operation Requires:

- Blade Shield & Shoulder Harness with Bar Handle or U-Handle

Wear Proper Clothing.

CONTENTS

GRAPHIC WARNINGS	2
SAFETY PRECAUTIONS	3
DEFINITION OF TERMS	5
CURVED SHAFT MODELS — CLOCKWISE ROTATION	6
STRAIGHT SHAFT MODELS — COUNTERCLOCKWISE ROTATION	7
PROTECTIVE DEVICES	8
COMBINATION OF CUTTING HEADS, SHIELDS, HANDLES, ETC.	9
RULES FOR SAFE OPERATION	10
CUTTING WITH NYLON LINE	16
CUTTING WITH BLADES	21
ECHO ATTACHMENTS AND ACCESSORIES	24

SAFETY PRECAUTIONS

WARNING DANGER

Read the operator's manual carefully. Be familiar with the controls and the proper use of the unit. Know how to shut the unit off, and how to unhook a harnessed unit quickly.

- Do not allow a person to use this unit unless instructions are read and understood. Never allow children to operate or play with the unit.
- There is a great risk of eye loss from thrown objects. Always wear qualified eye protection in accordance with ANSI Standard Z87.1.
- Wear proper clothing to protect feet, legs, and other exposed parts of your body. Wear hearing protection devices. Also wear dust masks to filter out pollen and other irritants when deemed necessary.
- Do not wear opened-toed shoes or go barefoot or bare-legged. Do not wear loose or dangling clothing, neckties, scarfs, or jewelry which could be caught in the unit or the underbrush.
- Keep people out of the danger zone. This is a circle 15 meters in radius (about 16 paces) around the unit and operator.
- Require any persons outside the 15-meter danger zone to wear eye protection to help protect them from thrown objects.
- If necessary to cut where people or cars could be hit by thrown objects, cut at reduced (slow) throttle speed to reduce the speed of the nylon line or blade, thus reducing the velocity of thrown objects.
- Adjust the handle to a position for comfort and good balance as recommended in this manual.
- Check that the cutting line or blade of the unit is away from your feet and legs.
- Be sure the unit is assembled properly.
- The muffler side of the engine should be away from your body. This is necessary to avoid arm burns.
- The unit is designed to be used while positioned on the right side.
- Always use the appropriate harness, properly worn, when one is provided with the unit. Balance the unit as recommended by adjusting the position of the harness clamp on the shaft. If the unit is not provided with a harness, you can obtain one from your dealer to reduce fatigue from operation.
- Follow instructions in this manual when operating the unit with a blade. The blade can be made of metal or other materials such as rubber or plastic. Do not use this unit as a hammer, lever, crowbar, hatchet or ax. Do not misuse the blade or the unit. Do not raise the line or blade head above your knee height. Your unit is not a pruner, hedge trimmer or chain saw and should not be substituted for these tools.
- When operating the unit with a blade, be sure the blade is attached to the unit as designed, such as with a locknut and cotter pin. Also, be sure the blade unit has a metal debris shield, has either a metal bar handle or a U-handle, and is suspended from a shoulder harness.

SAFETY PRECAUTIONS (CONTINUED)

- A bladed unit can kickout, causing serious injury to helpers, bystanders or animals. Keep people and animals at least 15-meters (approximately 50 feet) away. Use proper procedures to keep control of the unit.
- The blade can push, pull or kickout, causing the operator to lose his balance or lose control of the unit.
- Keep blades clear of fences, wires, posts, rocks, etc. to prevent kick out and blade damage.
- Do not operate when under the influence of alcohol, medications or substances which can affect your vision, dexterity and judgment. You must be in good physical and mental health in order to operate safely.
- Do not operate where the unit could contact electrical conduits, house wiring, or any power lines.
- Handle flammable fuel with care. Use an approved type can. Do not smoke or bring sparks or flame near the fuel supplies. Use proper fueling procedures as recommended in the operator's manual.
- Never refuel while the engine is running or hot. Move at least 10 feet from the fueling spot before starting the engine.
- Do not store the unit with fuel in the tank, because a fuel leak could start a fire.
- Do not run the engine indoors or where there is poor ventilation. Engine fumes contain deadly poisonous carbon monoxide.
- Never operate the unit without the proper debris shield and other protective devices in place. Replace damaged or broken debris shields.
- Do not operate a semi-automatic feed type line head if the debris shield is not equipped with a cut-off knife.
- Never operate without good visibility and light.
- Never start the engine if the drive shaft is not in place to prevent the engine from over speeding or the clutch from flying apart.
- For starting position, lay the unit down in a clear area so the line or blade cannot contact the ground or any other obstruction.
- Hold the unit down firmly so you will not lose control during cranking. If not held down properly, the engine could pull you off balance or swing the cutting line or blade into an obstruction of your body.
- Do not crank the engine while the unit is harnessed to you or otherwise suspended above ground level.
- Always keep both hands on the control handles. Do not operate one-handed. Do not hold material you are cutting.
- Keep the unit and attachments in good working condition. Tighten fastening parts at regular intervals. Check the cutting head assembly before each use.
- After shutting down the engine, keep fingers and feet away from the cutting line or blade until all rotation stops. If the cutting head coasts for a long time instead of stopping right away, adjust the carburetor per instructions in your operator's manual, or have the adjustment made by your ECHO servicing dealer.
- Shut down immediately if the unit starts to shake or vibrate. This could be a sign of danger from a broken part or missing fasteners.
- Disconnect spark plug wire before you work on the unit or leave it unattended.
- Do not cut with dull blades which can increase the risk of kickout and breakage. Before operating unit, thoroughly inspect blades for damage and cracks. Do not use a damaged blade.
- Replace dull 80-tooth Brush Blades if you cannot have them sharpened professionally. Do not try to resharpen them yourself.
- Sharpen dull 8-tooth Grass/Weed Blades at the proper angles with a flat file. Do not file down into the gullet (bottom) are of the tooth. The gullets must be rounded, with no sharp corners or filing nicks which could be the start of stress cracks and blade failure.
- ECHO may produce new design attachments and blades from time to time. If you purchase such an item, follow the installation, operation and maintenance instructions supplied with it.
- Do not mount any ordinary circular saw blade, a lawnmower or edge/trimmer blade, or a grinding type cut-off wheel on your Grass/Weed Trimmer or Weed/Brush Cutter.
- Do not use any blade or attachment not authorized for your unit by ECHO, Inc.
- All maintenance given in the operator's manual should be performed by you or an ECHO servicing dealer. Any service or repair work for which the operator's manual does not give instructions must be done only by an authorized ECHO servicing dealer.
- The debris shield, also known as a cutting attachment shield, located at the lower rotating head, is intended to reduce the chance of thrown objects hitting the leg. Do not rely on the debris shield to protect the eyes from thrown objects. Wear eye protection goggles conforming to the ANSI Z87.1 Safety Standard (Z87 is stamped on the goggles).
- Secure hair above shoulders.
- Never use wire or wire rope in place of nylon monofilament cutting line.
- Spark arrester mufflers are standard on ECHO units to reduce the possibility of forest fires. Do not operate the unit with a loose or defective muffler. Do not remove the spark arrester screen.

GLOSSARY

ANSI Z87.1 - The established standard for eye protection devices, set forth by the American National Standards Institutes (ANSI).

BARRIER - A device, such as a bar handle, U-handle or harness, which restrains the unit's cutting attachment from moving rearward and making inadvertent contact with the operator's legs.

BLADE RETAINER - A mechanism which holds the brushcutter blade to the driving member.

BLADE THRUST - Another name for Kickout.

BOUNCE - The ricochet of a flying object from any surface, particularly from the ground, rocks or buildings.

BRUSHBLADE - A multi-tooth circular saw blade for sawing heavy brush with SRM models only.

CUTTING CIRCLE - The blade perimeter or the circle formed by a cutting line.

CUTTING HEAD - The assembly that includes the flexible cutting line or a blade. Flexible cutting line heads include:

- **BUMP-ADVANCE HEAD** - Extends the line through a bumping mechanism.
- **CENTRIFUGAL-ADVANCE HEAD** - Extends the line through speed changes.
- **MANUAL HEAD** - A flexible line suspension mechanism requiring manual adjustments of the line length.

DANGERZONE - A 15-meter (or approximately 50-foot) radius surrounding the operator of the unit. No one else but the operator should be in the Danger Zone while the unit is being used. (See Risk Zone.)

DEBRIS SHIELD - The shield just behind the cutting head. Also called a cutting attachment shield.

DEFLECTION - A glance, or bounce, or change of path of a thrown object off a hard surface.

EDGING - Trimming the grass along an edge such as a sidewalk.

FACE MASK - A mask to shield face from flying objects. Face masks alone do not provide adequate protection. Eye protection goggles meeting ANSI Standard Z87.1 must be worn underneath. (See "GOGGLES.")

FACE SHIELD - A device worn in front of the eyes and a portion of, or all of, the face to supplement protection afforded by a primary protective device. Face shields alone do not provide adequate protection. (See "GOGGLES.")

GOGGLES - A device covering eyes and sockets, flush against the face, having impact-resistant lenses. Such goggles must meet the ANSI Z87.1 Standard ("Z87" is stamped on the goggles).

GT - Grass Trimmer

GRASS TRIMMER - A grass and weed-cutting unit with a nylon line cutting head. Not to be used with a metal blade.

HARNESS - The adjustable strapping by which the unit is suspended from the operator. A **SHOULDER/WAIST HARNESS** must be worn by the operator when the unit is equipped with a blade for cutting. A **SHOULDER HARNESS** when blade-cutting with a bar handle or U-handle is acceptable. Also, it is advisable to wear a harness when using a flexible line trimmer to help reduce fatigue.

HEARING PROTECTION - Ear muff or plug-type devices worn to reduce exposure to harmful noise while permitting an operator to hear certain sounds.

HIT - When a thrown object hits someone or something and is capable of injury or penetration.

IMPACT SPEED - The speed of a striking object.

IMPACT ENERGY - The energy from a thrown object that is transferred to another object or person during impact.

HANDLES:

- **BAR HANDLE** - A straight metal handle, standard on some SRM units.
- **D-HANDLE** - A looped handle.
- **U-HANDLE** - Has the configuration of a U-shaped bicycle handle bar which reduces the working effort compared to a D-handle.

KICK OUT - When the unit dangerously propels itself out of a cut due to blade binding. The direction is opposite the blade rotation at point of contact. (See page 22.) Also called Blade Thrust.

MAXI-CUT WEED CUTTER - A 3-blade flail-type device which can be used in place of the nylon line head.

PUSH & PULL - Forces exerted by the blade. If the blade pulls, the unit will pull away from the operator. If the blade pushes, the unit pushes back towards the operator. (See page 22.)

QUICK-RELEASE MECHANISM - A mechanism controlled by the operator to quickly release the unit from the harness in case of emergency.

RICOCHET - A thrown object which glances off a surface and takes a new path.

RISK ZONE - The area beyond the 15-meter (or approximately 50-foot) radius surrounding the operator of the unit. Bystanders in the Risk Zone should wear eye protection against thrown objects. Risk diminishes with distance from the operator. (See Danger Zone).

SRM - Shoulder Rotary Mower

SHOULDER ROTARY MOWER - A flexible-line grass and weed-cutting unit which can be converted for use with a blade.

SCALPING - The very close cutting of vegetation from the earth. A trimmer is used to clear growth around trees or shrubs, or from sidewalks.

SCYTHING - An arcing motion to cut weeds by swinging the tool head from side to side.

GLOSSARY CONTINUED ON NEXT PAGE



**CLOCKWISE
HEAD ROTATION**

CURVED SHAFT MODELS



GT SERIES

GRASS/WEED
TRIMMERS

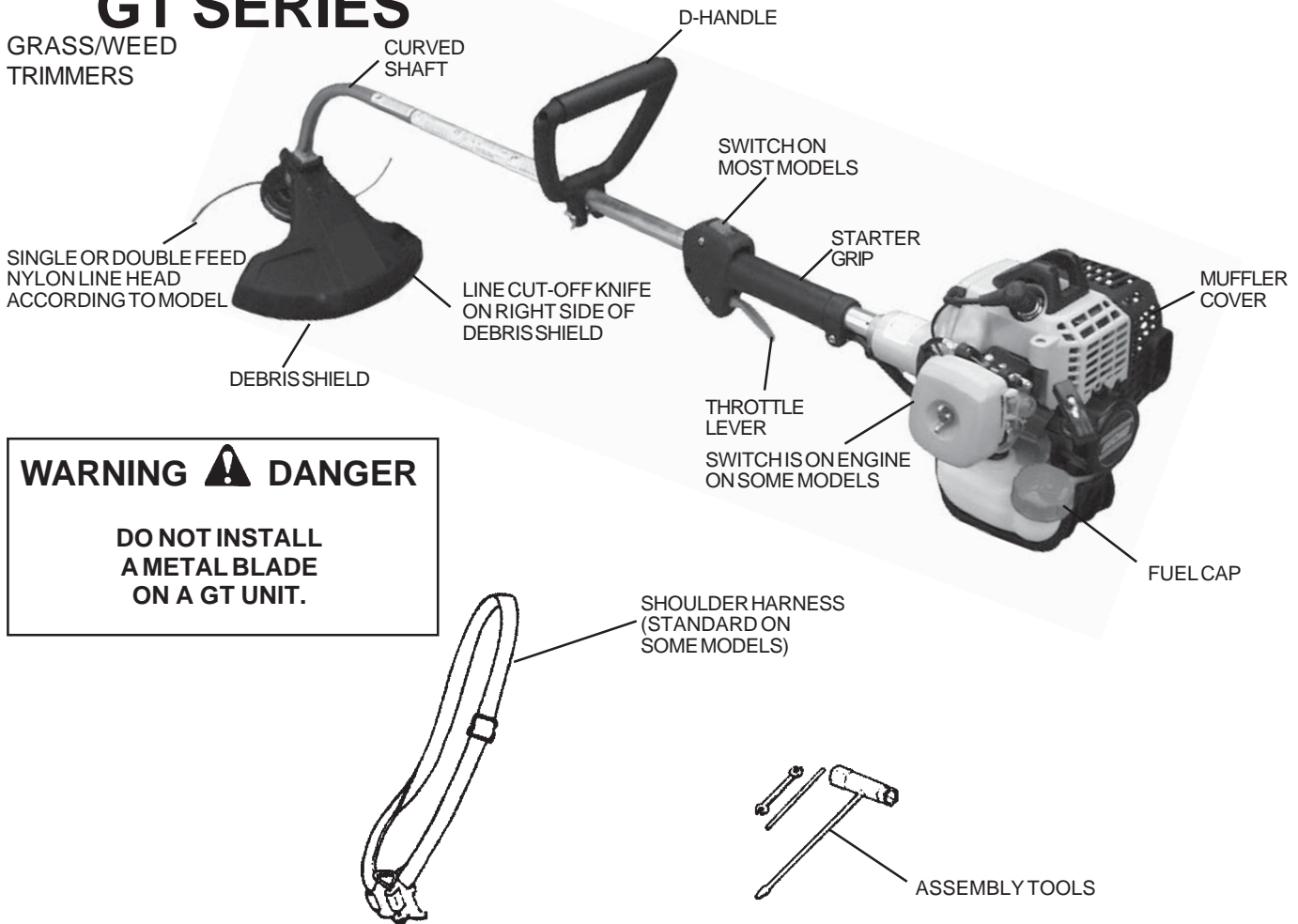

WARNING  **DANGER**

**DO NOT INSTALL
A METAL BLADE
ON A GT UNIT.**

GLOSSARY (CONTINUED)

STRESS CRACK - Structural damage resulting from misfiling of blade teeth, pinching in a cut or using the blade as a lever.

TIP SPEED - The speed of the cutting line or blade (in mph or fpm) at the perimeter of the cutting circle.

THROWN OBJECT - A projectile propelled from flexible cutting line or a blade capable of causing bodily injury to the operator or bystanders.

TRIMMER - A GT or SRM unit when fitted with a line cutting head or Maxi-Cut Weed Cutter. Metal blades are recommended only on SRM units with special conversion kits.

UNIT - Powerhead, shaft and cutting assembly.

U-HANDLE - Has the configuration of a bicycle handle bar to reduce working effort compared to a D-loop handle.

WEED/GRASS BLADE - A blade to cut heavy grass and weeds.



STRAIGHT SHAFT MODELS SRM SERIES



GRASS/WEED/BRUSH CUTTERS

SHOULDER ROTARY MOWERS CONVERTIBLE FOR METAL BLADE USE

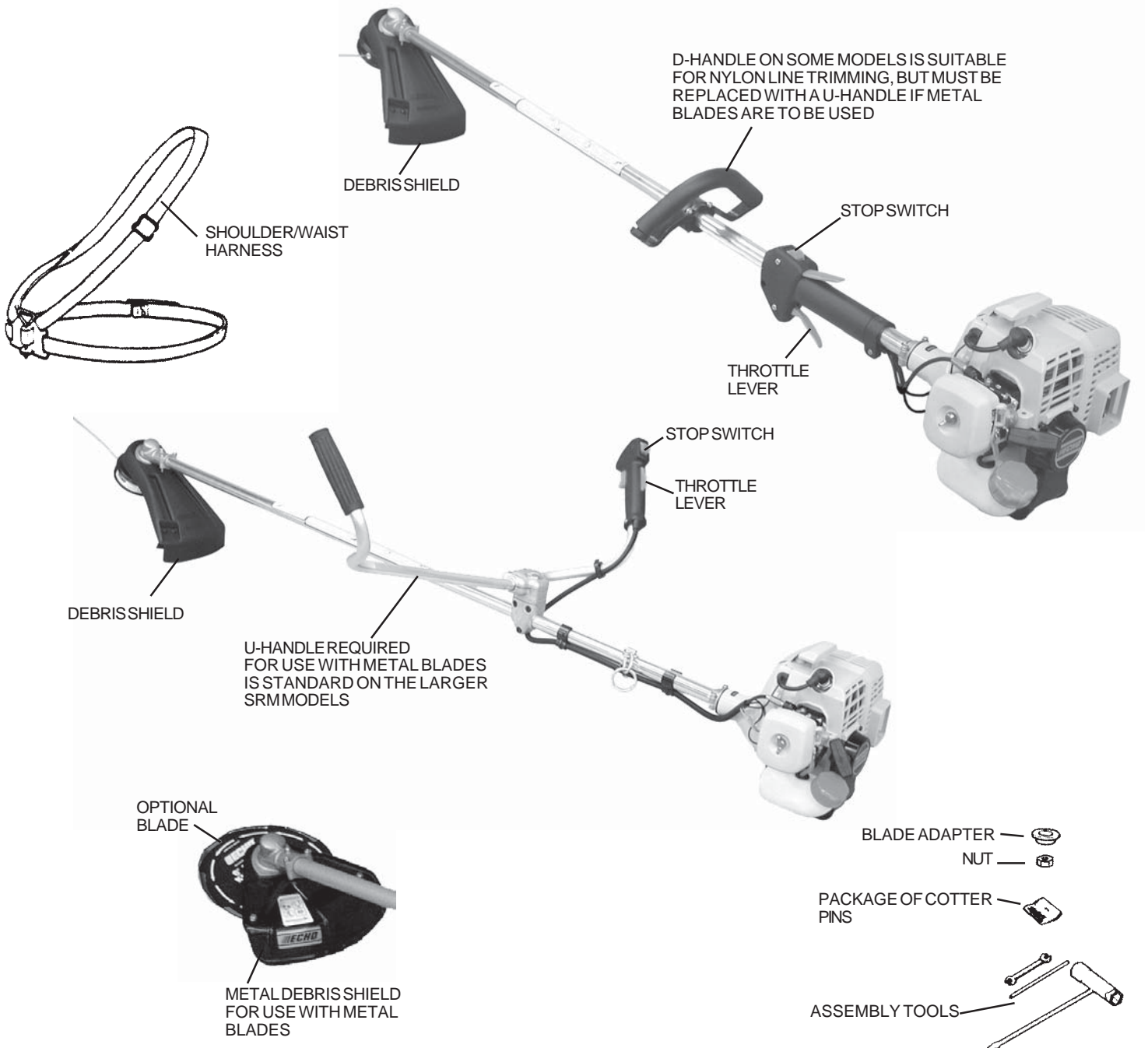

PROTECTIVE DEVICES TO BE WORN BY OPERATOR

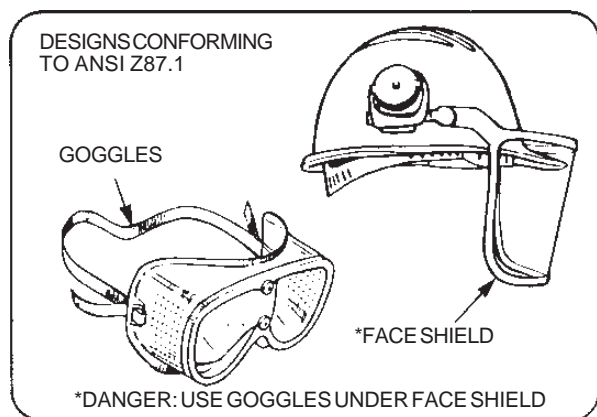

EYE AND FACE PROTECTION

At the minimum, the operator **must** wear eye approved protection, not only against objects thrown by the unit, but also because eye infections can be caused by airborne dust, seeds and pollen.

ECHO safety goggles are stamped Z87 as being in compliance with ANSI Standard Z87.1 for eye protection devices. Prescription glasses may be worn under the safety goggles. Eye protection should also be worn by persons in the risk zone which extends beyond the danger zone. (See pages 8-11.)

If operating conditions require additional face protection, flip-down face shields in conformance with ANSI Standard Z87.1 are also available. The face shields may attach to a safety "hard hat". Safety goggles must be worn underneath.

HEARING AND EAR PROTECTION

ECHO recommends wearing hearing protection at all times. If not followed, hearing loss can occur after frequent and lengthy exposure to engine noise. You should reduce the risk of hearing damage by wearing with "headset" type protectors or approved ear plugs. "Head sets" may also prevent ricocheted objects from entering the ears.

PROTECTIVE CLOTHING

Choose pants, shirts and jackets that fit trimly and have no strings, frills or dangling straps which could catch on the unit or the underbrush. Do not wear ties, loose clothing or jewelry. Keep clothing buttoned or zipped up and shirt tails tucked in.

The wearing of gloves offers some protection against contact with skin irritants such as poison ivy. Soft leather work gloves may also improve your grip.

FOOT AND LEG PROTECTION

Long pants and sturdy shoes with non-slip soles are generally acceptable protection against objects thrown by a nylon line trimmer. For heavy brush cutting with metal blades, logger's pants or leg chaps with protective inserts and adequate protective boots are an added consideration.

ADDITIONAL PROTECTION

Hay fever (rhinitis) sufferers may purchase disposable masks at hardware or medical supply stores to help reduce the intake of allergenic particles.

COMBINATIONS OF CUTTING HEADS, SHIELDS, HANDLES, ETC...

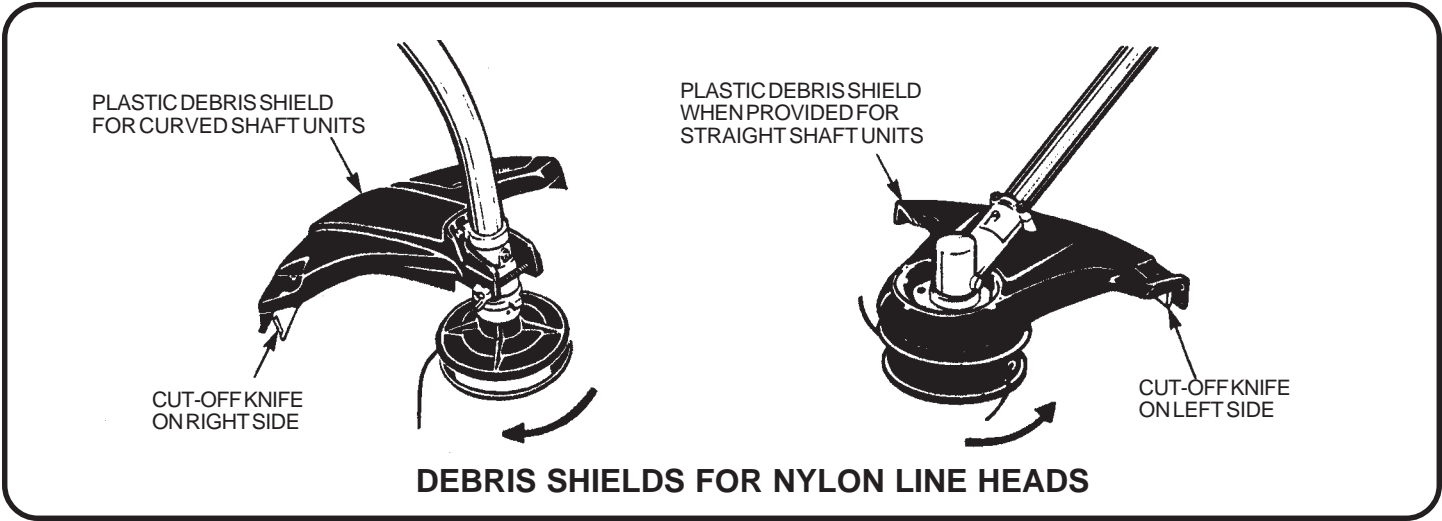

BASIC COMPONENTS AVAILABLE FOR METAL BLADE USE

REVIEW THE OPERATOR'S MANUAL FOR PROPER PROCEDURE WHEN CONVERTING FROM NYLON LINE HEAD TO BLADE APPLICATION

1. IF UNIT HAS A PLASTIC DEBRIS SHIELD, REPLACE WITH METAL BLADE SHIELD. SEE OPERATOR'S MANUAL.

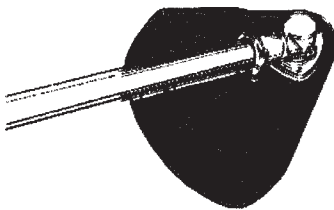

2. IF UNIT HAS A D-HANDLE, REPLACE WITH A BAR OR U-HANDLE

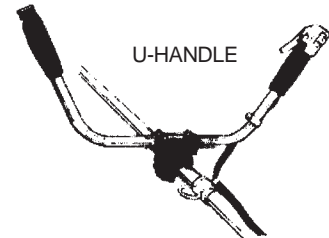
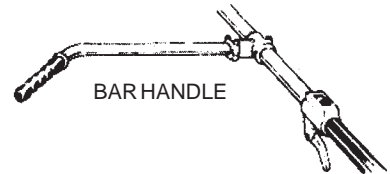

3. SELECT AND INSTALL THE BLADE OF YOUR CHOICE.*

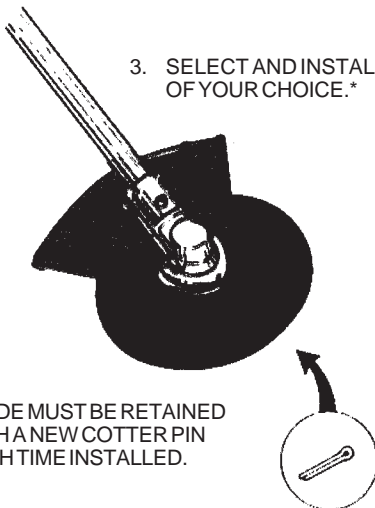

BLADE MUST BE RETAINED WITH A NEW COTTER PIN EACH TIME INSTALLED.



4. INSTALL THE SHOULDER/WAIST HARNESS.

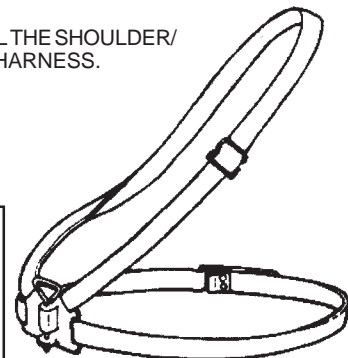

* CHECK DEALER FOR NEW CUTTING BLADES OR HARNESSES WHICH MAY BE INTRODUCED FROM TIME TO TIME

WARNING  **DANGER**

DO NOT INSTALL A METAL BLADE ON A GT UNIT.

RULES FOR SAFE OPERATION

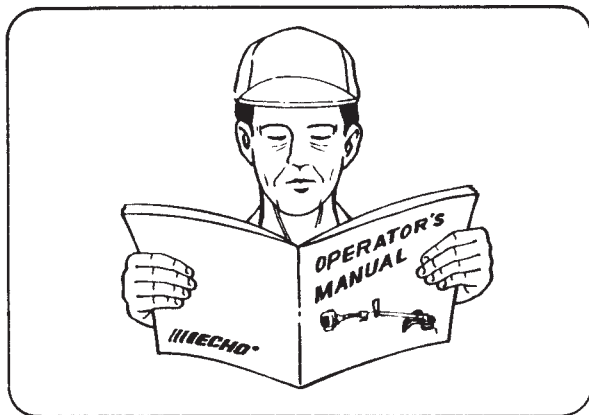

TRAINING

WARNING DANGER

All model trimmers and brushcutters can throw small gravel, stone, glass, metal or plastic objects as well as the material being cut. Read these "Rules for Safe Operation" with care. Follow instructions in this safety manual and in your operator's manual.

Read the operator's manual carefully. Be thoroughly familiar with the controls and proper use of the unit. Know how to stop the unit and shut off the engine. Know how to unhook a harnessed unit quickly.

Never allow anyone to use the unit without proper instruction. Be sure the operator wears the foot, leg, eye, face and hearing protection recommended on page 8 and has read the operator's manual and this safety manual.

Always wear approved eye protection from thrown objects when operating. The eye protection devices available from ECHO are stamped "Z87" and are in accordance with ANSI Standard Z87.1. Do not rely on any face shield to protect your eyes. Do not rely on the debris shield on the unit to protect your eyes from ricocheting or thrown objects.

Keep the area clear of bystanders, children and pets.

Never allow children to operate or play with the unit.

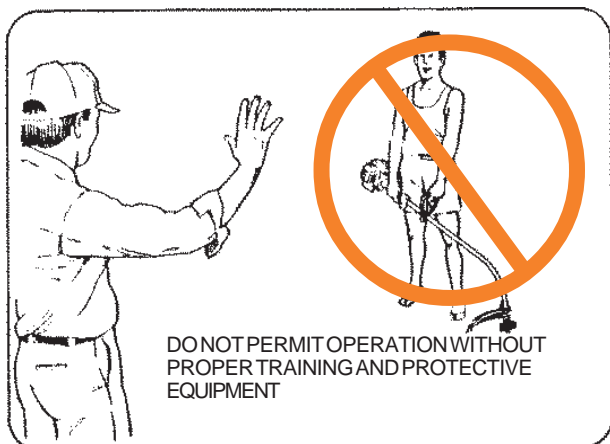

WEAR EYE/EAR PROTECTION

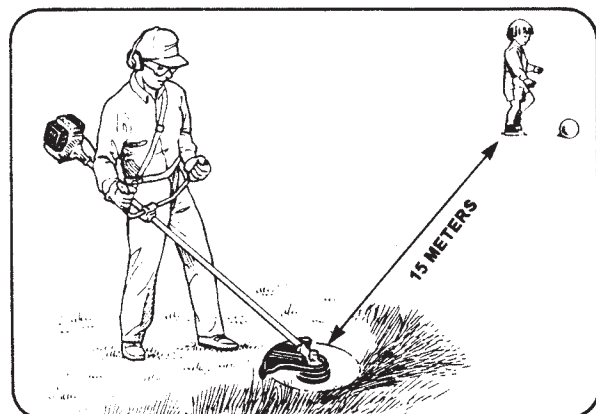

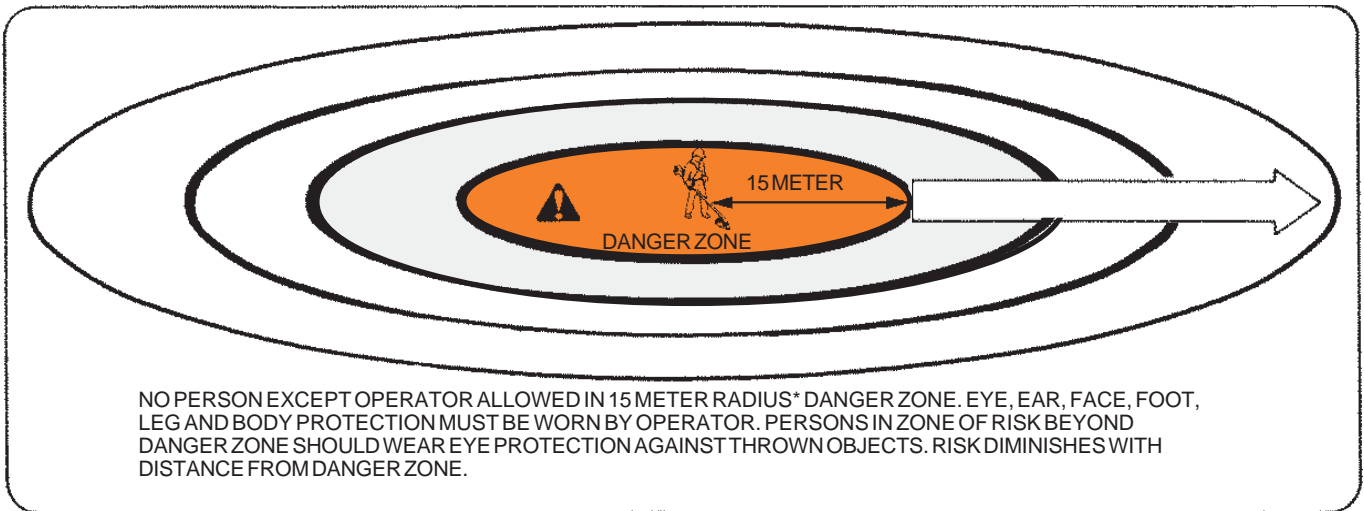

Do not allow anyone to enter the operating DANGER ZONE with you. The danger zone is an area 15 meters in radius (about 16 paces) or 50 feet.

Insist that persons in the RISK ZONE beyond the danger zone wear eye protection from thrown objects. If the unit must be used where there are unprotected people, operate at a low throttle speed to reduce the risk of thrown objects.

WARNING  DANGER

Beyond the 15-meter (50-foot) DANGER ZONE, there still may be risk of eye injury from thrown objects. The risk diminishes with distance. But eye protection should be considered for everyone in the zone of risk.

PREPARATION

WARNING  DANGER

In addition to head, eye, face and ear protection from thrown objects, wear protective clothes and sturdy shoes to protect your feet and improve footing on slippery surfaces. Do not wear ties, jewelry, or loose, dangling clothing which could be caught in the unit. Do not wear open-toed footwear, or go barefoot or bare legged. In certain situations you must assess whether total face and head protection may be required.

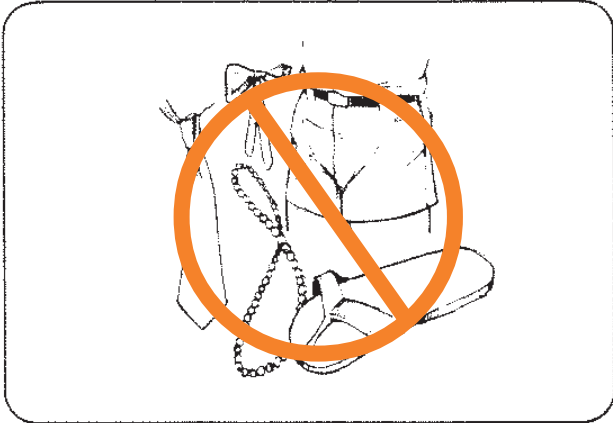

When coupling the shaft to the powerhead, be sure the muffler side of the engine is to the right when the debris shield is in level position.

Install the handle in position for optimum comfort and good control of the tool. See the operator's manual for handle installation.

* This DANGER ZONE has been increased from a 10 to 15 meter radius to include the cutting of small trees that may fall on other adjacent operators performing the same work.

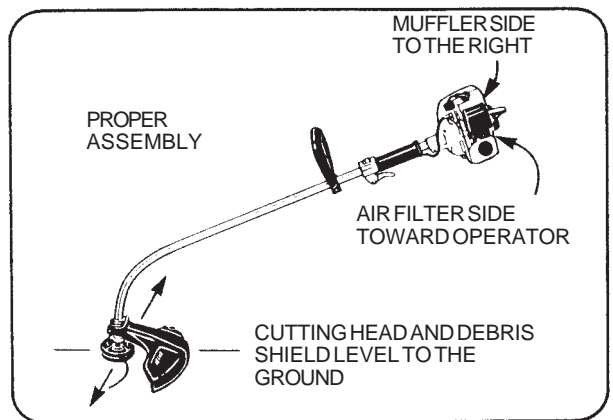

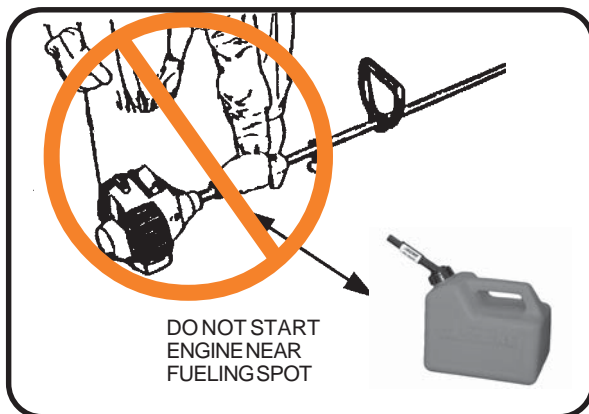
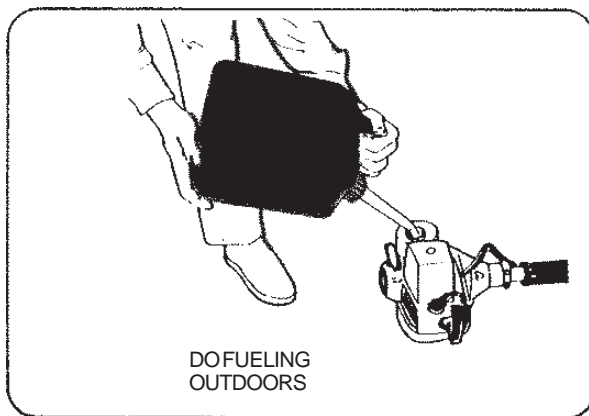
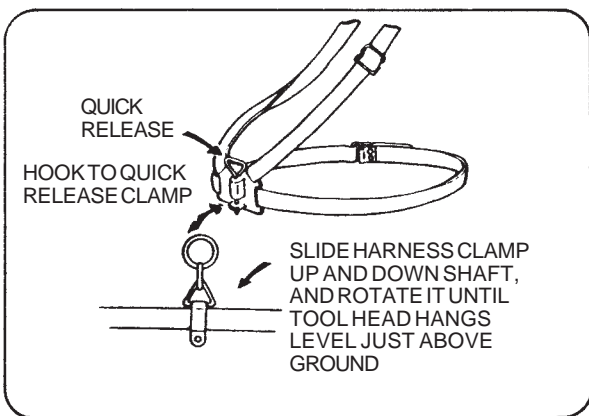
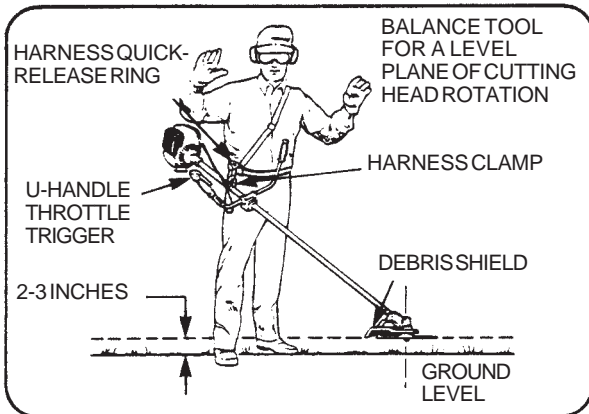

SEE THE OPERATOR'S MANUAL FOR PROPER HANDLE INSTALLATION.

Use a shoulder harness when provided or when recommended in this manual. Adjust both harness and the harness clamp on the unit so the unit hangs with the cutting head a few inches above ground level. The cutting head and debris shield should be level in all directions. Harness the unit on the right side as shown.

- Slide harness clamp up and down the shaft to find the right balance. Rotate the clamp to level the cutting head and debris shield. Lock in position. If the harness clamp is a free-spinning type, the unit may tend to roll over sideways; however, you should still level the head and shield on the front-to-rear axis.
- Balancing and leveling, as above, may require relocation of the clamp and readjustment of the harness straps. Also, each type of cutting head and debris shield mounted on the unit may require balancing.

NOTE

A person's size can affect the balancing adjustment. Also, the balancing procedure may not work with some ECHO units on some persons. If the procedure does not work for you, please ask your ECHO servicing dealer for assistance.

WARNING DANGER

Echo trimmers and brushcutters are designed to fit a wide variety of body sizes, but may not be adjustable for extremely tall persons. Do not use the unit if your feet can reach the blade when the unit is attached to the harness.

Handle fuel with care. It is highly flammable.

- Use an appropriate type fuel container.
- Do not smoke or bring flame or sparks near fuel supplies.
- The fuel tank may be under pressure. Always loosen the fuel cap and wait for pressure to be equalized before removing the cap.
- Fill the fuel tank outdoors over bare ground and install the fuel cap securely. Do not pour fuel indoors.
- Wipe any spilled fuel off the unit. Then move at least 10 feet from the fueling spot before starting the engine.
- Never refuel while the engine is still hot, or fuel a running engine.
- Do not store the unit with fuel in its tank, because a fuel leak could start a fire.

You should be in good mental and physical health. Do not operate if you are under the influence of alcohol or any medication or substance which could affect your vision, dexterity or judgment.

Inspect the area before using the unit. Remove objects which the unit could throw or become entangled with. Remember where there are obstructions to be avoided. It is good practice to remove any debris (wire, rocks, wood, cans, glass, etc.) after cutting an area. Later, when the area grows back, you will have reduced the accumulation of hidden debris which the unit could throw.

Inspect the unit before using it. Perform only maintenance or adjustments for which the operator's manual gives instructions. Do not try to repair the unit without proper instructions. The unit should be serviced only by trained ECHO dealer servicemen with the proper tools. Be sure that:

- a) Engine does not leak fuel.
- b) Fasteners are tight, and none are missing.
- c) Muffler complies with local fire codes and noise ordinances and is in good condition. (Spark arresters may be required.)
- d) The unit has the proper equipment—shields, handles, harness, etc.—for the line or blade head to be used.
- e) If a blade (made of metal or other materials such as rubber or plastic) is used on the unit, be sure the blade is attached to the unit as designed, such as with a cotter pin and nut. Do not cut with dull, cracked or damaged metal blades.

WARNING  **DANGER**

Never start the engine if the drive shaft is not in place to prevent the engine from overspeeding or the clutch from flying apart.

GENERAL OPERATION

Do not run the engine indoors, or where there is poor ventilation. Engine fumes contain deadly poisonous carbon monoxide.

Wear the recommended foot, leg, head, eye and hearing protection at all times during operation. Also, assess the job to be done, and whether other types of protection may be necessary. (See page 8.)

Before starting, check that the cut-off knife is properly located in the debris shield, and the line does not extend far beyond the knife.

Never operate the unit without the proper shields and other protective devices. (See page 9.)

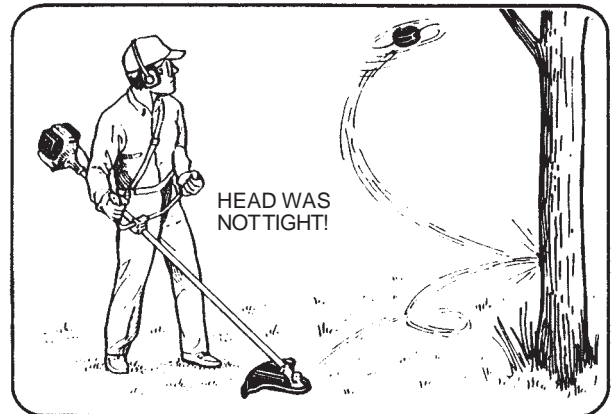
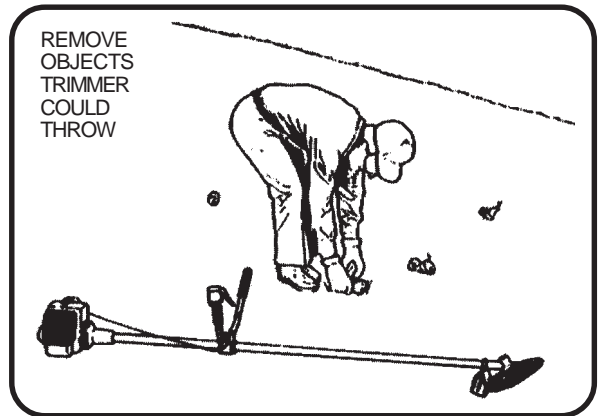

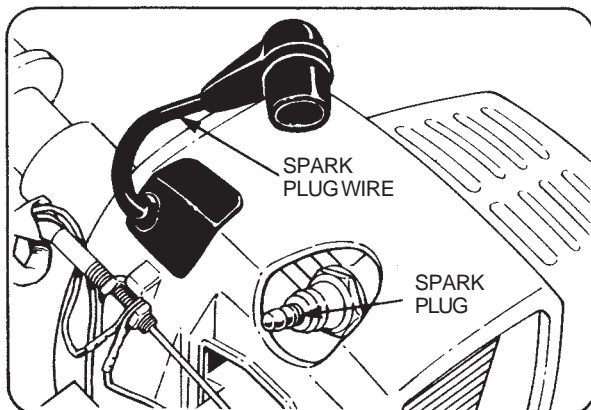
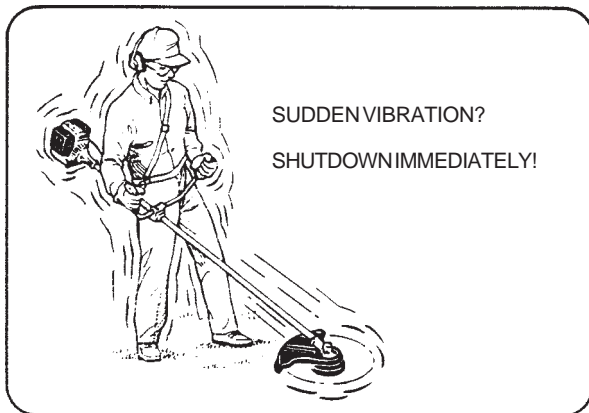
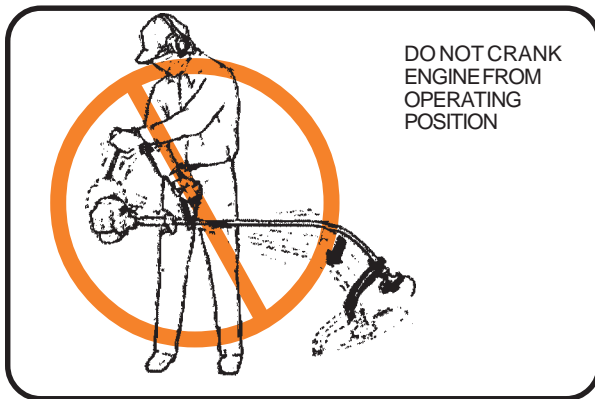
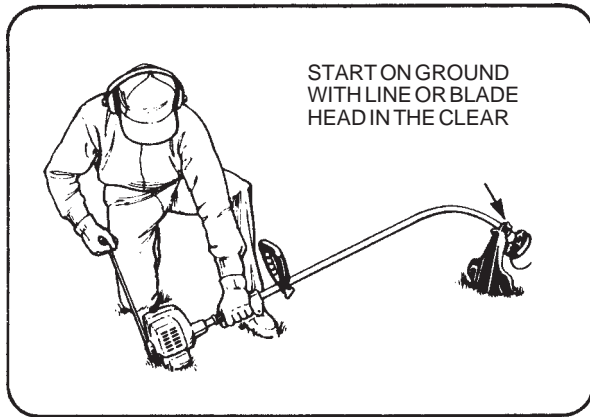

Never operate the tool without good visibility and light.

Lay the unit down on a clear area and set the controls for starting. While cranking the unit, use one hand to pull the starter handle and the other hand to stabilize the unit. To be sure the cutting line or blade cannot contact the ground or any obstruction, rest the unit on the debris shield (see illustration at left).

Hold the unit firmly down so you will not lose control during cranking. Do not crank the unit in the air, or from a harness. The unit could swing into your leg or an obstruction if you lose control.

Do not raise the cutting head above knee height. If raised higher, the cutting head will be more directly in line with your face. Thrown objects may cut your face and eyes.

Keep the unit and attachments in good working condition. Tighten loose fastening parts and replace any missing fasteners before using the unit. Check the cutting head assembly before each use.

Shut down immediately if the unit starts to shake or vibrate. A sudden vibration is a sign there may be danger or trouble, such as a broken flywheel, clutch or cutting blade, or loose parts. Do not use the unit until the trouble has been properly diagnosed and corrected.

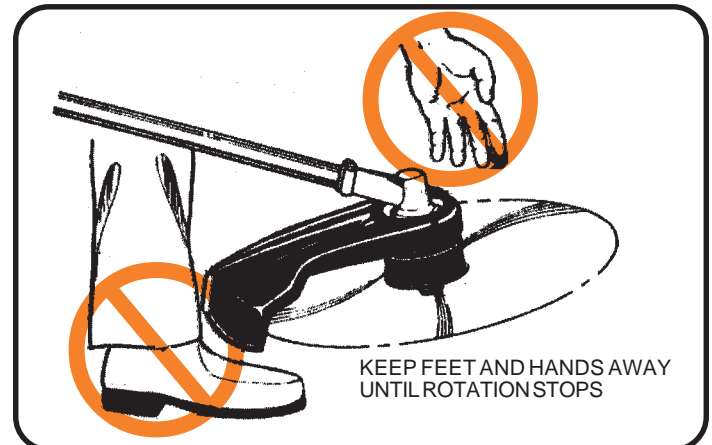

After shutting down the engine, wait until all rotation of the unit stops before going near the cutting head. If the cutting head rotates after the engine returns to idle, a carburetor adjustment may be needed. You can follow your operator's manual to make adjustment yourself, or have the carburetor adjusted by your ECHO servicing dealer.

All maintenance and adjustments given in the operator's manual should be performed by you or your ECHO servicing dealer on a timely basis. ALL required service or repair must be done only by the ECHO servicing dealer.

Always disconnect the wire from the spark plug to make the engine unstartable before you work on the unit or leave it unattended.

WARNING DANGER

Use only ECHO cutting attachments on your unit. Do not mount a metal blade on any unit of the GT series. Do not mount an ordinary circular saw blade, lawnmower blade, edge/trimmer blade, or grinding type cut off wheel on your ECHO Weed/Grass Trimmer or Weed/Brush Cutter.

- Always use both hands on the handles. Do not operate one-handed.
- Always hold the unit with the fingers and thumbs encircling the handles.
- Keep bystanders out of the Danger Zone (a 15-meter radius surrounding the operator).
- For transport in a vehicle, tie the unit down, and either remove or shield metal blades from contact with any surface.

RAYNAUD'S SYNDROME—Some operators may develop a condition known as Raynaud's Syndrome affecting the hands or arms. It is believed that the condition, brought by exposure to cold and/or vibration, may result in tingling and burning and then by loss of color or numbness in fingers. Even if you ECHO model has anti-vibration mounts, we recommend your taking the following precautions because the minimum exposure which might trigger the ailment is unknown.

- Keep your body warm, especially the head and neck, hands and wrists, and feet and ankles.
- Avoid awkward, unnatural, stressful grips on the unit without losing control. Avoid hard, stiff "death grips" while the unit is vibrating.
- Maintain good blood circulation. Avoid smoking. Exercise vigorously during frequent work breaks. Also limit the amount of time you spend using this or any other hand-held vibrating tool.
- If you experience discomfort, redness and swelling of the fingers followed by whitening and loss of feeling, consult your physician before exposing yourself further to vibration and cold.

REPETITIVE STRESS INJURIES (RSI)—It is believed that overusing the muscles and tendons of the fingers, hands, arms and shoulders may cause soreness, swelling, numbness, weakness and extreme pain to the areas just mentioned. Certain repetitive hand activities may put you at a high risk for developing Repetitive Stress Injury (RSI). An extreme RSI condition is Carpal Tunnel Syndrome (CTS), which can occur when your wrist swells and squeezes a vital nerve that runs through the area. Some believe prolonged exposure to vibration may contribute to CTS. CTS can cause severe pain for months or even years. To reduce the risk of RSI or CTS, do the following:

- Avoid using your wrist in a bent, extended or twisted position. Instead, try to maintain a straight wrist position. Also, when grasping, use your whole hand, not just the thumb and index finger.

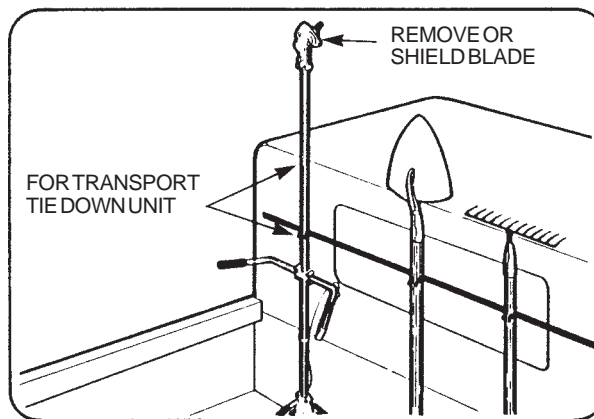
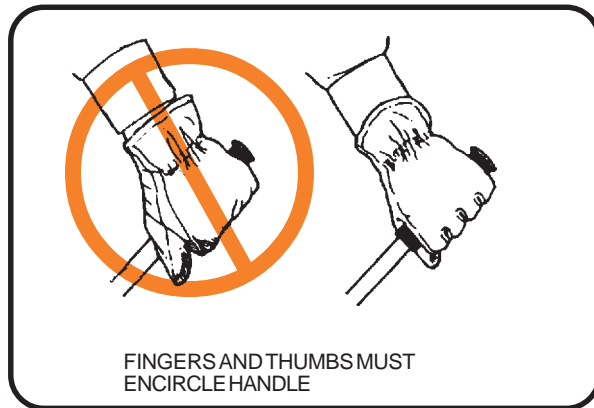

- Take periodic breaks to minimize repetition and rest your hands.
- Reduce the speed and force in which you do the repetitive movement.
- Do exercises to strengthen the hand and arm muscles.
- Wear a shoulder harness to reduce stress on our hands and arms.
- See a doctor if you feel tingling, numbness or pain in the fingers, hands, wrists or arms. The sooner RSI or CTS is diagnosed, the more likely permanent nerve and muscle damage can be prevented.



CUTTING WITH NYLON LINE

WARNING DANGER

One of the intended purposes of the debris shield is to reduce the risk of the operator's legs from being struck by thrown objects. The debris shield, however, should NOT be relied upon to provide protection for the eyes from thrown objects. Always wear approved eye protection goggles. The debris shield is also intended to assist the operator when starting the unit on the ground (the unit is rested on the debris shield, thus helping to keep the cutting line or blade in the clear). The debris shield can also help the operator determine the reach of the cutting line during operation as well as provide a limited barrier between the operator's feet and the cutting attachment.

NOTE

There are two columns of pictures for each column of procedures in this part of the manual. One column shows curved-shaft units, the other column is for straight-shaft units. Disregard the column which does not apply to your unit. Study the pictures which apply to your unit.

WARNING DANGER

Some units have a plastic debris shield. The plastic shield has a razor-sharp knife which trims the line whenever it becomes too long. If your unit has a debris shield with a cut-off knife, do not cut yourself when handling the line head and shield. Do not operate if the cut-off knife is missing.

CURVED SHAFT UNITS

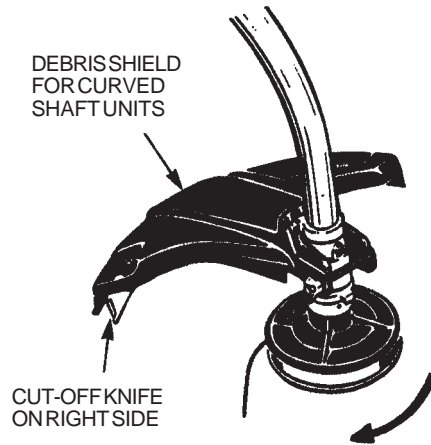

If your unit has a curved shaft, line head rotation is clockwise. The knife will be on the right side of the debris shield.

DEBRIS

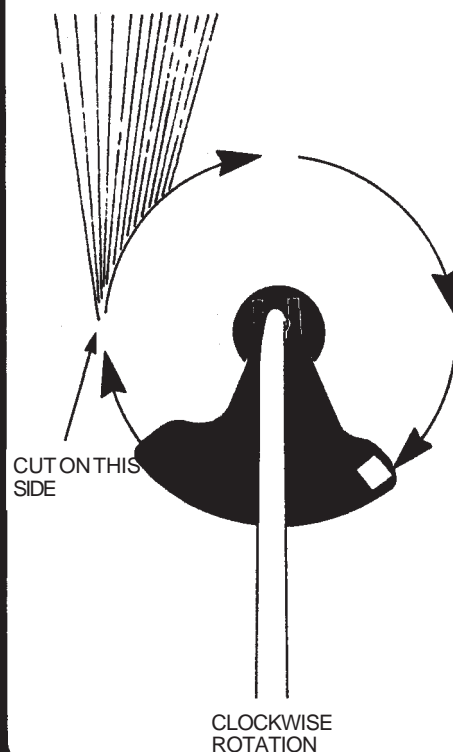

STRAIGHT SHAFT UNITS

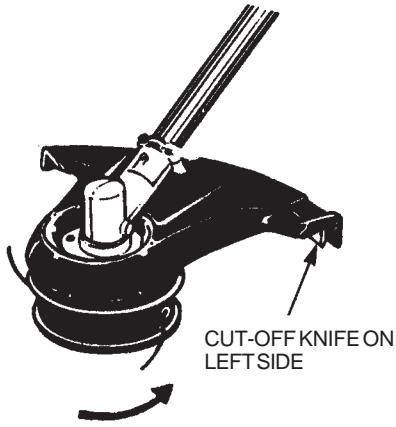

If your unit has a straight shaft, line head rotation is counterclockwise. The knife will be on the left side of the debris shield.

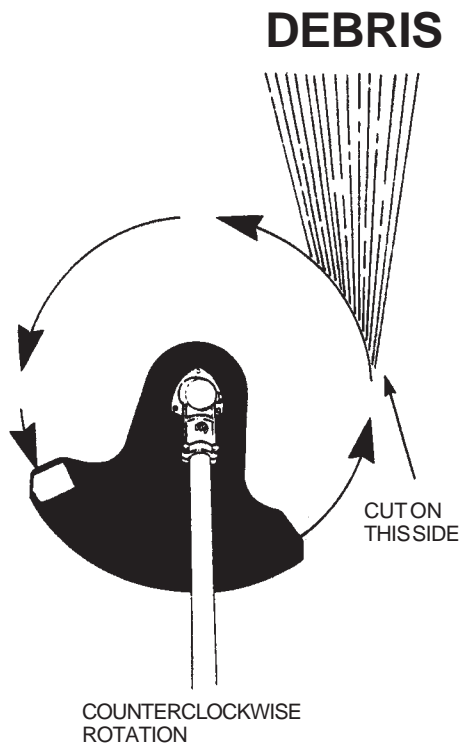

The proper debris shield must be in place on the unit when nylon cutting line is used.

- Units with Echomatic™ semi-automatic line head must have a debris shield with cut-off knife.
- Units with manual feed line head or blade head require a debris shield. Consult your operator's manual for the proper debris shield.

WARNING DANGER

The cutting line can flap around if too much line is exposed. Always reinstall the plastic debris shield and cut-off knife when converting the unit for use with a semi-automatic feed type line head. A metal shield does not trim line.

For nearly all cutting, it is good to tilt the line head so that contact is made on the part of the **line circle** where the line is moving **away** from you and the debris shield. (See appropriate picture.) This results in the debris being thrown **away** from you.

Tilting the head to the wrong side will shoot the debris toward you. If the line head is held flat to the ground so that cutting occurs on the whole line circle, debris will be thrown at you, drag will slow the engine, and you will use up a lot of line.

WARNING DANGER

Use only ECHO quality nylon monofilament line of the diameter given in your operator's manual. Never use wire or wire-reinforced line in place of nylon trimmer line. Load your nylon line cutting head only with nylon trimmer line of the proper diameter.

WARNING DANGER

Use extreme caution when operating over bare spots and gravel, because the line can throw small rock particles at high speeds. Debris shields on the unit cannot stop objects which bounce or ricochet off hard surfaces.

The basic cutting actions pictured are: **Trimming, scything, scalping and lawn edging.** These actions are as follows

TRIMMING: This is feeding the trimmer carefully into the material you wish to cut. Tilt the head slightly to direct debris away from you. If cutting up to a barrier such as a fence, wall or tree, approach from an angle where any debris ricocheting off the barrier will fly away from you. Move the line head slowly until the grass is cut right up to the barrier, but do not jam (overfeed) the line into the barrier. If trimming up to wire mesh or chain link fencing, be careful to feed **only up to the wire.** If you go too far, the line will snap off around the wire.

Trimming can be done to cut through weed stems one at a time. Place the trimmer line head near the bottom of the weed—never high up, which could cause the weed to chatter and catch the line. Rather than cut the weed right through, just use the very end of the line to wear through the stem slowly.

SCYTHING: This is the cutting or mowing of large grassy areas by sweeping or swinging the trimmer in a level arc. Use a smooth, easy motion. Do not try to hack or chop down the grass. The unit can be hand-held for scything. Scything is also very comfortable to do with the unit on a shoulder harness. Tilt the line head to direct the debris away from you on the scything stroke. Then return without cutting grass for another stroke. If you are well protected and do not care whether some debris is thrown in your direction, you may scythe in both directions.

SCALPING and EDGING: Both of these are done with the line head tilted at a steep angle. **Scalping** is removing top growth, leaving the earth bare. **Edging** is trimming the grass back where it has spread over a sidewalk or driveway. During both edging and scalping, hold the unit at a steep angle and in a position where the debris, and any dislodged dirt and stone, will not come back towards you even if it ricochets off the hard surface. Although the pictures show how to edge and scalp, every operator must find for himself the angles which suit his body size and cutting situation.

WARNING  **DANGER**

Do not use a blade for edging or scalping.

CURVED SHAFT UNITS

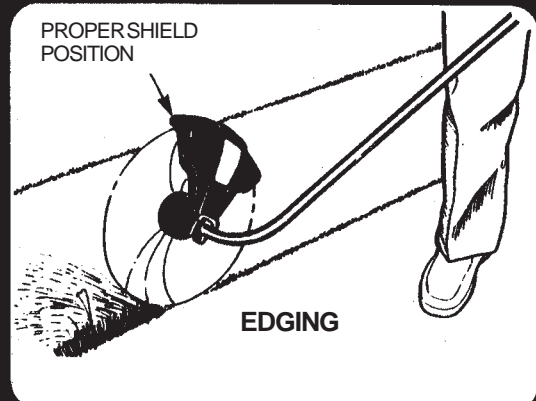
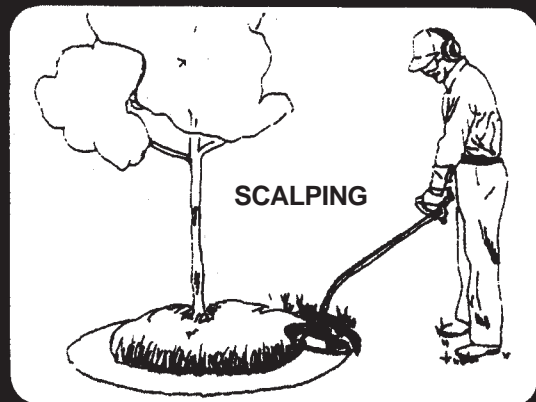
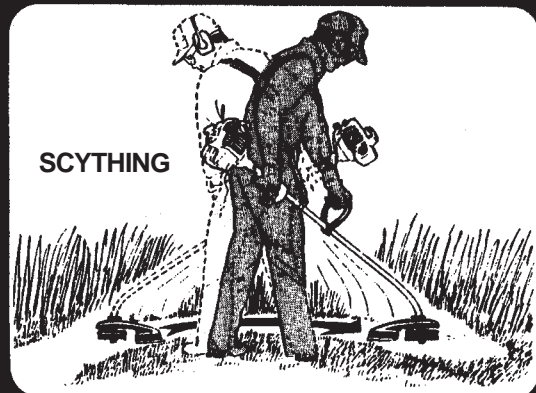
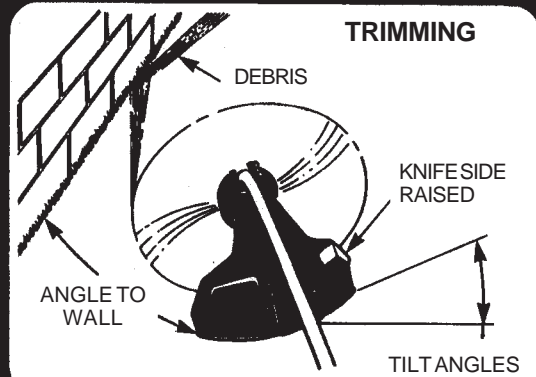

STRAIGHT SHAFT UNITS

TRIMMING

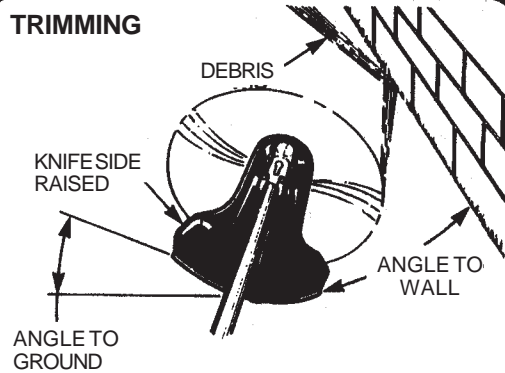

SCYTHING

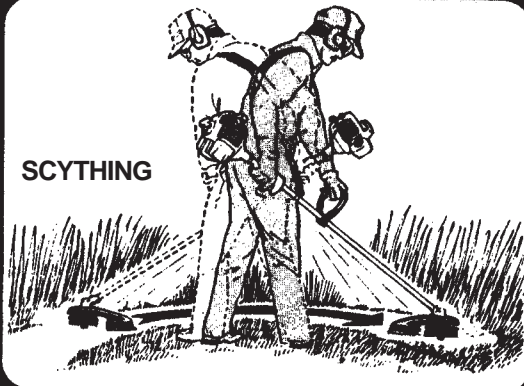

SCALPING



EDGING

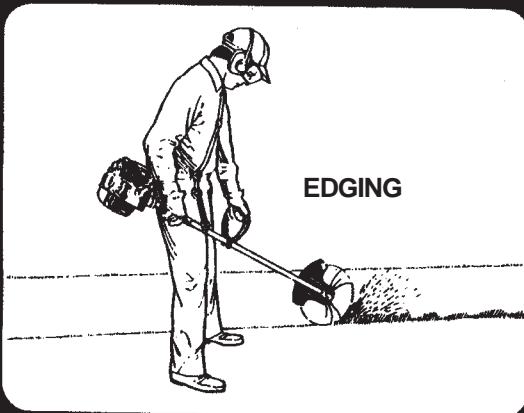

WARNING DANGER

Always check that there is a safe distance between the cutting device and your feet. Be sure to keep the cutting device away from your body during operation.

WEAREYE/EAR PROTECTION



NOTE

When scalping under the trees, do not cut into the soil where the surface roots could be injured, or feed the line into the bark of the tree.

WARNING DANGER

Do not use a blade for edging or scalping.

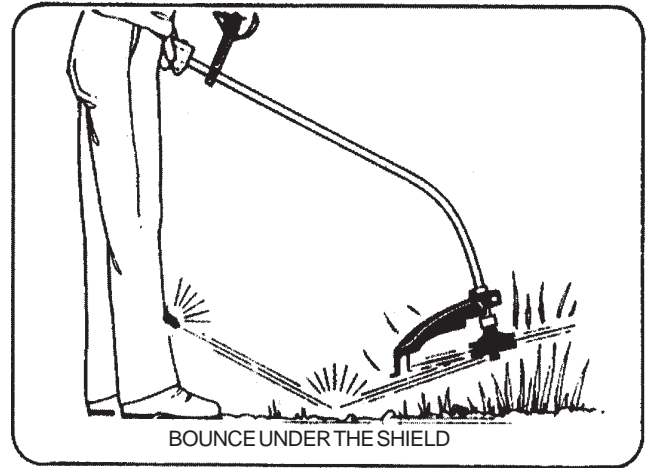
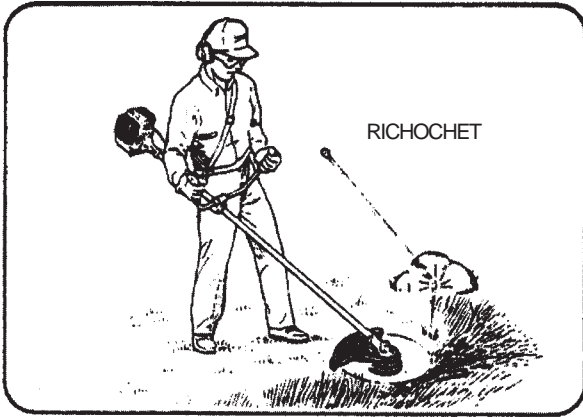

Always wear proper eye protection against thrown objects. Objects can bounce up at you from the ground under the debris shield, or ricochet off any nearby hard surface.

Do not trim at high blade or line speeds near roadways when there is traffic, or in places where there are pedestrians. If you must trim where people are in the zone of risk (see page 11) use a much lower or reduced blade or line speed, by using a partial trigger setting.

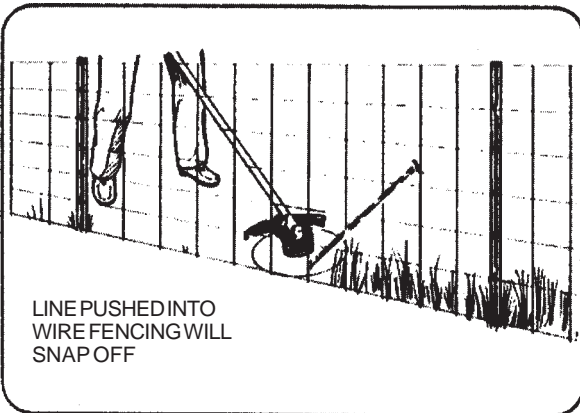

Do not push the line into tough weeds, trees, or wire fences. Pushing the line into chicken wire, chain link fencing or thick brush can result in snapped-off line ends being hurled back at the operator. The proper way is to cut right up to a barrier, such as any of those mentioned, but never run the line into or through the obstruction. Do not cut closely to obstruction or barrier.

Avoid trimmer line contact with broken wire fencing. Pieces of wire broken off by the trimmer can be hurled at high speeds.

WARNING  DANGER

Do not trim in any area where there are broken strands of fencing wire. Remove the broken pieces of wire, or give the area wide berth. Wear proper safety protection. Do not cut where you cannot see what the cutting device is cutting.

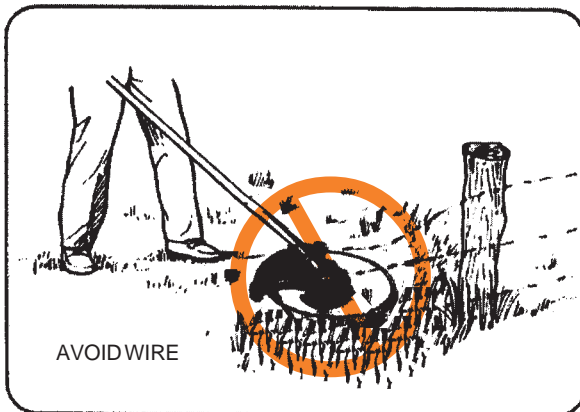

CUTTING WITH BLADES

WARNING DANGER

- Do not install a metal blade on GT series trimmer models, or any model which lacks a hole for the blade-securing cotter pin on the cutting head shaft.
- When using an SRM model with metal blades, replace the trimmer debris shield with the metal blade debris shield. (See operator's manual.) A brace is used on some models to support the shield.
- Also, use the unit with either a bar handle or a U-handle, a metal debris shield, a shoulder harness, and blade collar plus a nut and cotter pin. If your unit has a D-handle, convert to a U-handle.

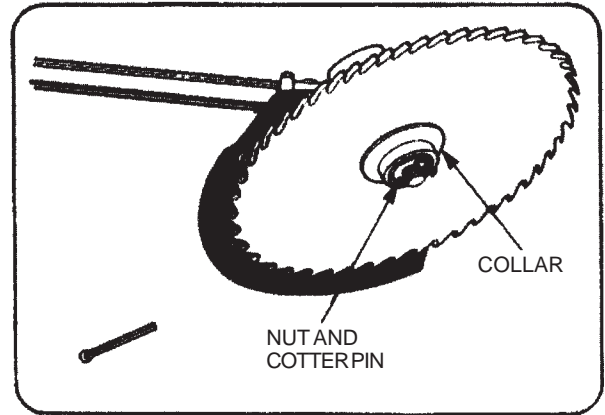

Install the blade properly with the teeth pointing in the direction your blade head rotates. Refer to the operator's manual for proper blade installation and tooth direction. Be sure to use a new cotter pin every time a blade is installed.

NOTE

A Maxi-Cut Weed Cutter may be installed on most ECHO GT or SRM series units in place of a line head assembly. A special interference-threaded lock nut is needed to secure it on GT series units with a curved shaft. Straight shaft units use a nut and cotter pin. The Maxi-Cut Weed Cutter can be used with either a plastic line debris shield or a metal blade debris shield. Installation instructions are on the Maxi-Cut package and in the operator's manual.

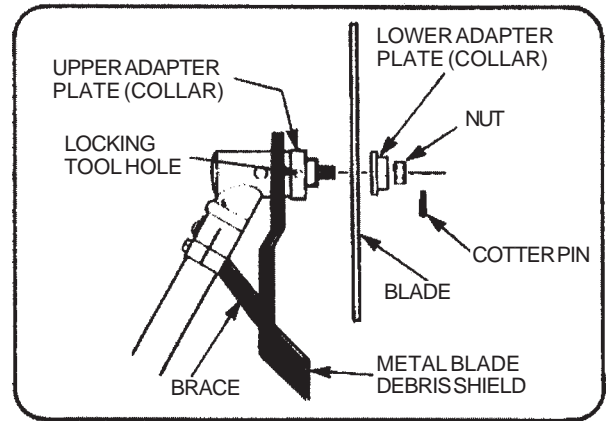

WARNING DANGER

If a kickout occurs with a blade unit, the operator's legs or bystanders can be severely injured. Always wear the required harness for the unit and be sure it is properly worn and secured.

WARNING DANGER

A metal blade SRM unit must have the items shown on page 9. These include either a bar handle or U-handle, a metal debris shield, a shoulder harness and a blade-retaining nut and cotter pin. These items are obtainable from your ECHO dealer who sold you your unit.

Adjust the shoulder harness to your body, and balance the assembled unit from the harness as instructed on page 12. Inspect the blades before use. The teeth must be sharp and there must be no cracks in the steel. Dull blades increase the risk of blade kick out reactions. Small cracks may grow to where a piece of the blade may fly off during operation.

WARNING DANGER

- Do not cut with dull, cracked or damaged metal blade.
- Before cutting growth, inspect for obstructions such as boulders, metal stakes or strands of wire from broken fences. If an obstruction cannot be removed, mark its location so that you can avoid it with the blade. Rocks and metal will dull or damage a blade. Wires can catch on the blade head and flap around or be thrown into the air.

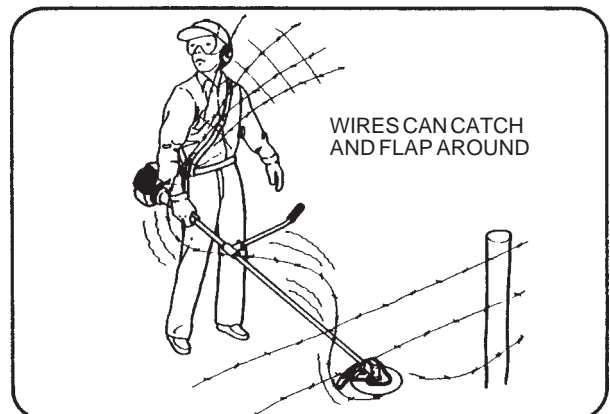

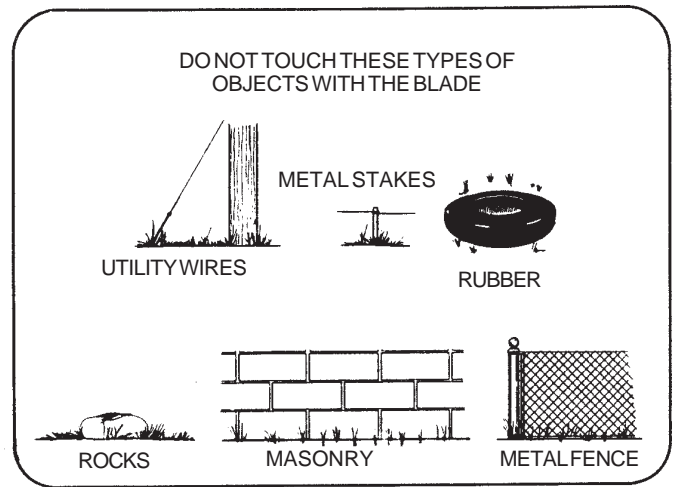
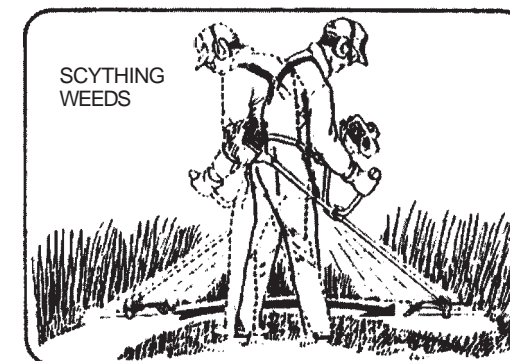
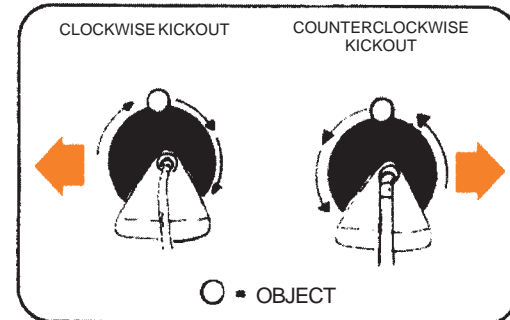
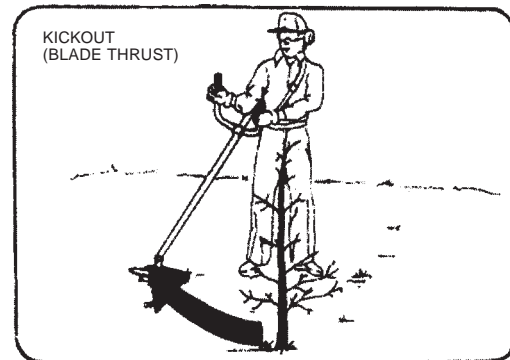
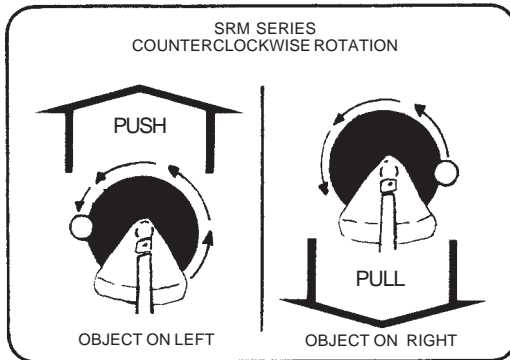
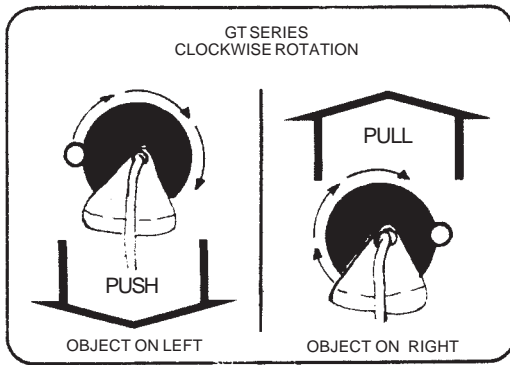

WARNING ⚠ DANGER

Be sure you understand the reaction forces of push and pull, and kickout (also called blade thrust), described in this manual, and how these forces may affect your balance in the operation of a bladed unit.

REACTION FORCES

PUSH. The operator feels the unit push toward him when he tries to saw with the blade on the side where the teeth are moving away from him. If he cannot hold the blade in the cut, a **kickout** may occur when the blade is pushed out to where the teeth at the outside furthest point from the operator are cutting. The blade will “kick out” sideways.

KICKOUT. This blade-thrust reaction may occur when the moving blade at the front of the blade circle contacts strong brush or trees. The force that occurs pushes the entire unit and blade violently away in an arc. Kickout is a danger to a bystander and also a jolting force to the operator.

PULL. The opposite of **push**. When the part of the blade where the teeth are moving toward the operator is used for cutting, the reaction is a **pull** away from the operator. Although this pull type of cutting may cause sawdust to be thrown back at the operator, it is recommended for **sawing** of heavy brush because the cutting is smoother and more stable than when the unit pushes.

NOTE

The direction of the kickout will depend on what unit model you are using. A curved-shaft GT model employs a clockwise rotation of its cutting head and will kickout to the left of the operator. The straight-shaft SRM employs a counter-clockwise rotation of its cutting head and will kickout to the right of the operator.

USING WEED BLADES

SCYTHING WEEDS. This is cutting by swinging the blade in a level arc. It can quickly clear areas of field grass and weeds. Scything should not be used to cut large, tough weeds or woody growths.

NOTE

Do not use a weed blade to cut brush or trees which exceed a diameter of 1/2 to 3/4 inches.

Scything can be done in both directions, or just in one way which results in the debris being thrown away from you. That is using the side of the blade that it is rotating away from you. Tilt down the blade slightly on this same side. You will be hit by some debris if you scythe in both directions.

SAWING. This must be done when weeds are too thick and strong for scything. Cut only with the side of the blade that is moving away from you.

If kickout keeps happening, the blade may be dull, or the material so thick and hard that you should use a Brush Blade instead of the Weed Blade.

USING BRUSH BLADES

WARNING DANGER

Brush Blades must be sharp. Dull blades require replacement or professional resharpening. Do not try to sharpen Brush Blades yourself.

There are two ways to cut with a Brush Blade: **scything** and **sawing**. The way you should choose depends on the hardness and size of the brush or trees to be cut down. Only very small, thin brush should be scythed. Never hack at brush or trees.

NOTE THAT OUR RECOMMENDATION FOR CUTTING WITH BRUSH BLADES IS THE OPPOSITE OF THAT DESCRIBED FOR WEED BLADES.

Growth up to 3-inches in diameter, which is too thick for scything, may be cut by **sawing**. Sawing requires judgment on your part whether to cut on the side where the blade **pulls** away from you but throws back the debris, or on the side where the debris is thrown away from you but the reaction is a **push** which could become a **kickout** (blade thrust).

Always cut on the side of the tree which will cause the tree to fall away from the unit. A **kickout** or **bind** may result if the tree falls toward the unit and pinches the blade.

Do not force the blade to cut. Do not change the angle of cut after cutting into the wood. Avoid using any pressure or leverage which could cause the blade to bind or crack.

SHUT OFF ENGINE IMMEDIATELY if the blade binds fast in a cut. Hold up the unit to keep side pressure off the blade. Reach forward and push the tree to free the blade.

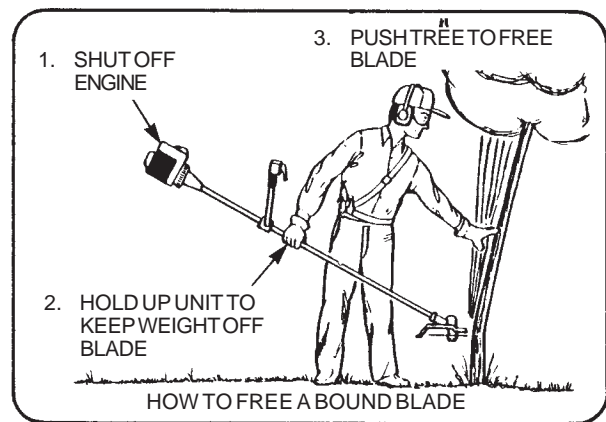
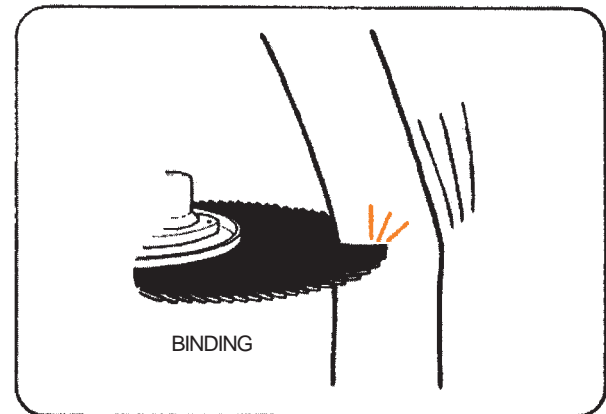
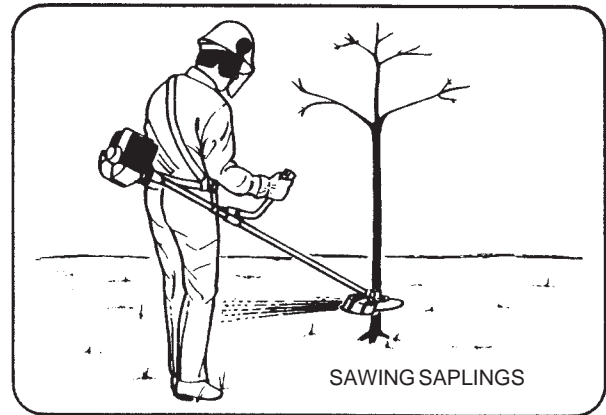

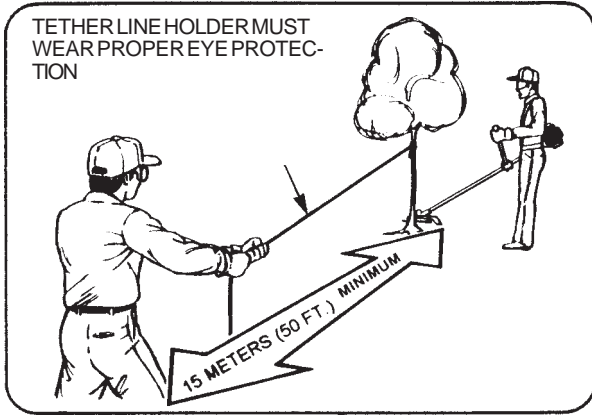

If a tether line is used to insure that a tree falls away from the blade, the line holder must wear proper eye protection and attire, and be no closer to the tool that 15 meters (50 feet).

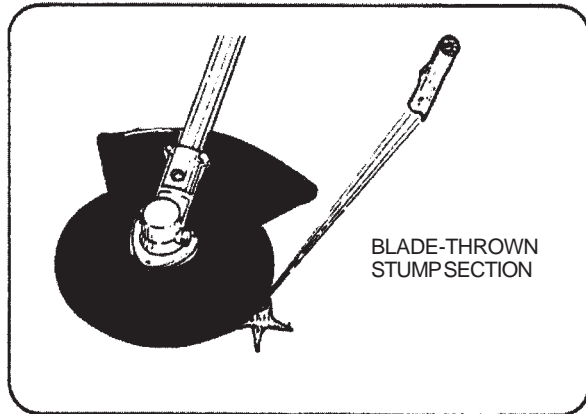

Be very careful when recutting cleared areas. If the blade can not cut clear through a short stump, it may tear it off and hurl it back at high speeds.

ECHO ATTACHMENTS & ACCESSORIES

ECHOMATIC™ NYLON CUTTING LINE HEADS

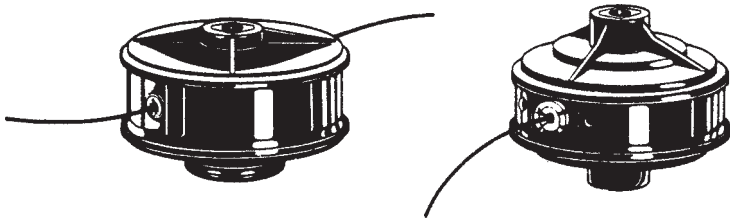

DUAL & SINGLE LINE SEMI-AUTOMATIC FEED LINE HEADS

Echomatic™ nylon line heads are standard on most ECHO GT or SRM series units. The line feeding action of the Echomatic™ head is called **semi-automatic** because the operator has to activate the head by tapping it on the ground. A plastic debris shield with cut-off knife must be used with a semi-automatic feed line head.

Manual feed nylon heads are standard on some units, and optional for all units. They require the use of appropriate debris shield as identified in the operator's manual for the specific units.



ECHOREPLACEMENT NYLON MONOFILAMENT TRIMMER LINE

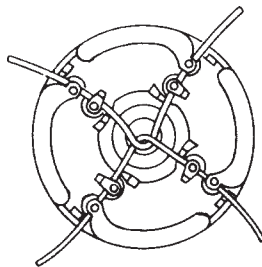

4-STRING MANUAL FEED LINE HEAD

If replacement of the cutting head assembly is ever necessary, install the assembly recommended in your operator's manual or unit parts list.

WARNING  **DANGER**

All heads must be used with a plastic debris shield.

ECHO FLEXIBLE WEED/GRASS BLADE FOR SRM UNITS ONLY

This three-bladed device, with a 10-inch radius, is made of flexible plastic on a rigid hub. Use in place of a nylon line head on ECHO SRM series units only. Not for heavy weeds or brush.

WARNING DANGER

A blade made of materials such as plastic or rubber can be equally as dangerous as a metal blade. Take every precaution possible when cutting with a blade no matter what material it is made of.

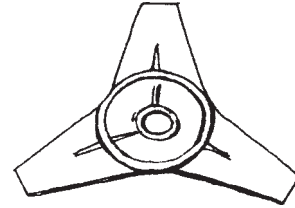

ECHO MAXI-CUT™ WEED CUTTER FOR GT AND SRM UNITS

The cutting circle is always at full diameter with this three-bladed, flail action cutter. Can be used on any ECHO GT or SRM series units for weed and grass cutting. Follow instructions in the operator's manual for proper assembly. Not for cutting brush. Sets of nylon replacement blades are available.

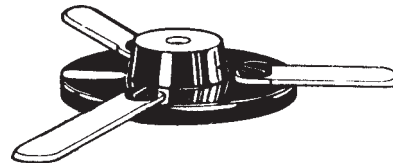

WARNING DANGER

MAXI-CUT must be used with a plastic debris shield.

ECHO METAL WEED/GRASS BLADE FOR SRM UNITS ONLY

The 8-inch diameter 8-tooth ECHO Weed/Grass Blade makes short work of field grass, garden debris and weeds. Handles thick, tough weeds. Must not be used to cut brush and heavy woody growth. Needs to be in sharp condition for good results.

WARNING DANGER

Pieces from a cracked metal blade can fly off during operation. Inspect metal blades for cracks before each use. Discard cracked blades no matter how small the crack. Cracked blades can be the result of misuse or improper sharpening.

The blade teeth can be sharpened to a 30-degree edge angle with a flat file. Use care not to file down into the rounded gullet area of the tooth or nick the gullet with the file. Nicked or sharp-cornered gullets can result in tiny stress cracks which keep lengthening until the blade breaks.

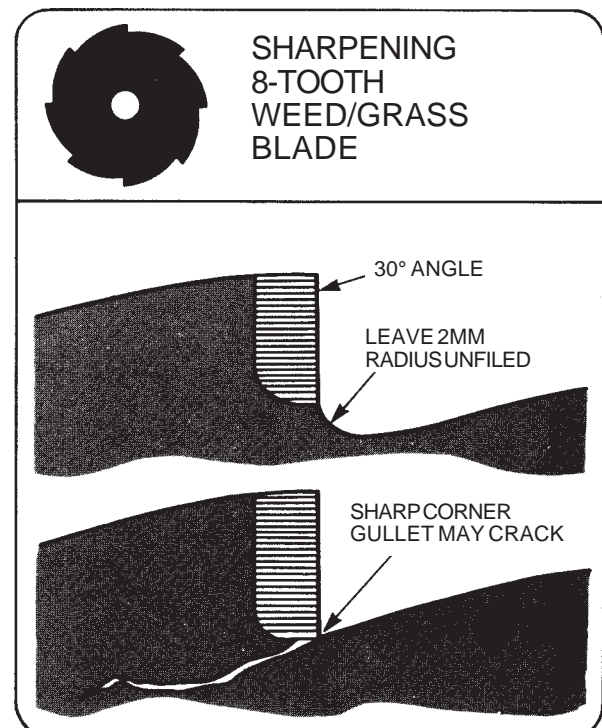

ECHO BRUSH BLADES FOR SRM UNITS ONLY

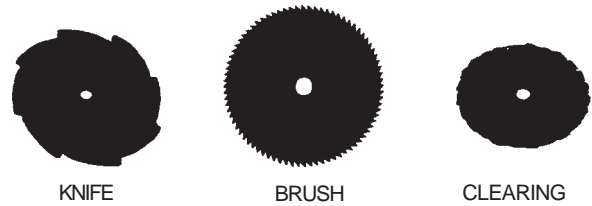
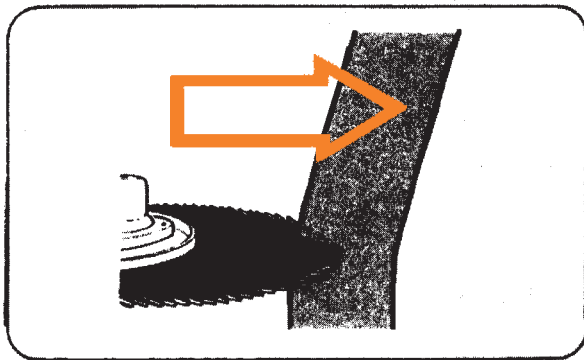
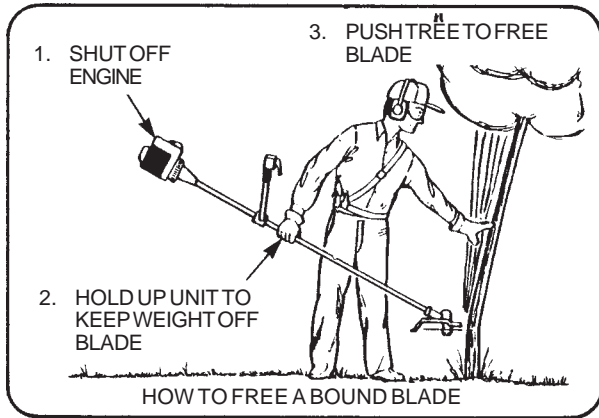

ECHO BLADES

There are three types of ECHO Blades: knife, brush and clearing blades. The ECHO products catalog lists the blade sizes available. These blades must be in sharp condition for both safety and good results. Have dull blades sharpened professionally or have them replaced.

Follow the instructions on page 23 for cutting with a brush blade.

WARNING DANGER

Never cut brush with a dull blade. Dullness increases the chance the blade may kick out of a cut.

If a sapling or shrub binds the blade, do not use the blade as a lever to free the bind, because this will cause blade failure. Instead, shut off the engine and push the sapling or shrub to free the blade. Do not use a cracked or damaged blade.

ECHO CULTIVATOR ATTACHMENTS FOR STRAIGHT SHAFT SRM UNITS

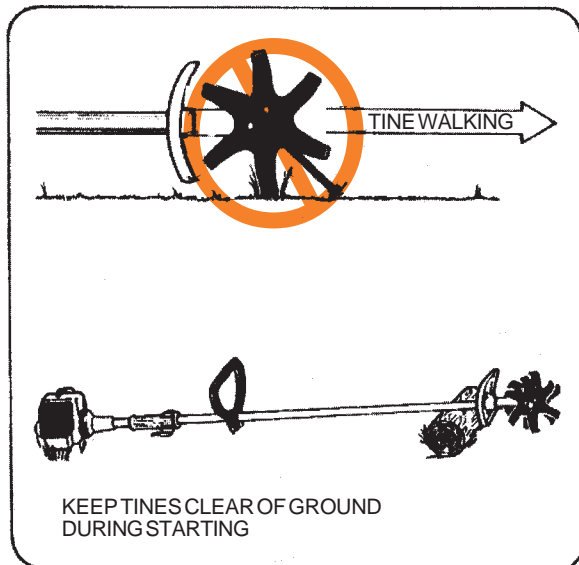

These attachments are designed to cultivate soft soil for weeding, preparing seed beds, mulching crop residues, preparing for germination in small fields, etc.

Read and follow instructions in your ECHO Weed/Grass Trimmer & Brushcutter Safety Manual for general operation of the unit. Consult the Cultivator Attachment Operator's Manual for assembly, safe operation and maintenance of the cultivator attachment. In addition, follow these precautions for safe and proper use:

Avoid **tine-walking** during starting. Tine-walking is the forward pull resulting when the rotating tines contact the ground or other obstruction. Start the engine at idle throttle and keep the tines in the clear during cranking. If the throttle must be advanced for starting, use some means of preventing possible contact of the tines with any object.

Guard against **kicking**. Obstructions in or on the soil can cause the tines to kick forward or upward. The tines can also kick back toward the operator if allowed to contact obstructions above them.

- a) Wear non-slip gloves and use the proper grip on the handles to keep control of the unit.
- b) Avoid contact with obstructions at or below ground level.
- c) Keep the tines at ground level. Do not raise the head where tine contact with wires, branches, etc. could cause you to lose control.

Maintain a balanced stance, and keep the cultivator head well away from your feet.

Always shut off the engine before clearing debris from the tines and hubs. Dry-clean the attachment after use.

Do not immerse the cultivator head in water or mud or wash it down, because moisture will harm the internal parts.

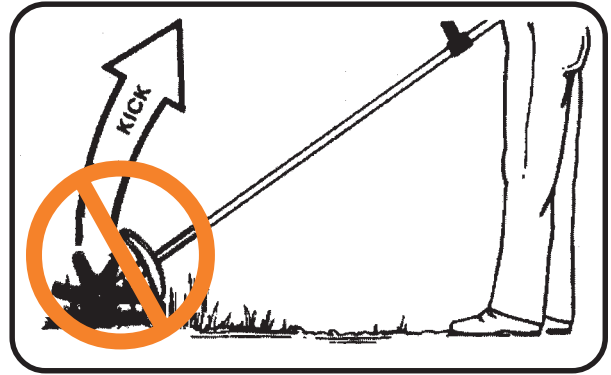

ECHO UNDERWATER CUTTING ATTACHMENTS FOR STRAIGHT SHAFT SRM UNITS

These reciprocating blade type attachments are for “straight shaft” SRM units only. They have waterproof heads designed for underwater weed cutting. The blade angle is suitable for low-level cutting.

Follow instructions in this safety manual for general operation of the SRM unit.

Follow instructions in the ECHO Underwater Cutting Attachment Operator’s Manual for assembly, operation, lubrication and maintenance of the attachment.

HERE ARE SOME SPECIAL PRECAUTIONS FOR THE SAFE USE OF THE UNDERWATER CUTTING ATTACHMENT.

Wear approved type (Z87) goggles to protect your eyes.

Operate the unit with a harness.

Keep the blade head clear of your body. Do not draw the blade head close to your feet.

Always shut off the engine before cleaning materials from the blade teeth.

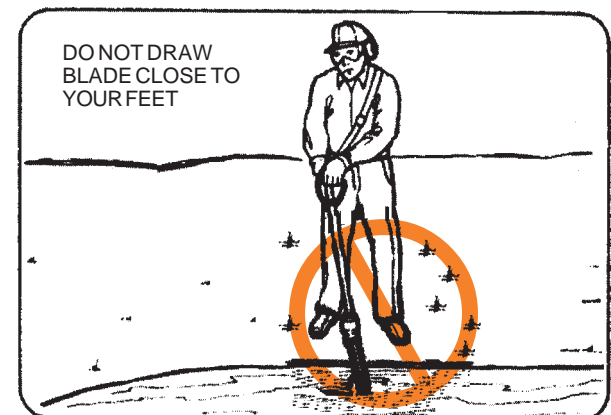
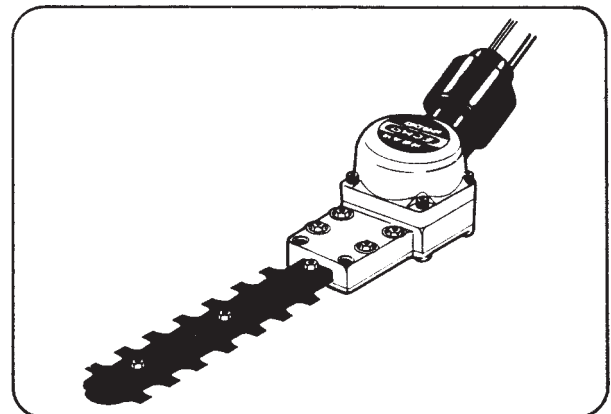



**ECHO INCORPORATED
400 OAKWOOD ROAD
LAKE ZURICH, IL 60047
www.echo-usa.com**

PRINTED IN U.S.A

Free Manuals Download Website

<http://myh66.com>

<http://usermanuals.us>

<http://www.somanuals.com>

<http://www.4manuals.cc>

<http://www.manual-lib.com>

<http://www.404manual.com>

<http://www.luxmanual.com>

<http://aubethermostatmanual.com>

Golf course search by state

<http://golfingnear.com>

Email search by domain

<http://emailbydomain.com>

Auto manuals search

<http://auto.somanuals.com>

TV manuals search

<http://tv.somanuals.com>