

OPERATOR'S MANUAL

ECHO WEED & GRASS TRIMMER GT-140B GT-160 GT-200A

CAUTION

Read Rules for safe Operation
and Instructions Carefully



898 561-0963 1

INTRODUCTION

The ECHO Weed and Grass Trimmers, models GT-140B, GT-160 and GT-200A, are light-weight, high performance and gasoline powered units which are designed for weed and grass trimming in areas which are difficult, and laborious, to control by any other means.

The model GT-140B is fitted with a 13.8cc engine, GT-160 is fitted with a 16.0 cc engine and The model GT-200A is fitted with a 21.2cc engine.

The models GT-160 and GT-200A are fitted with a semi-automatic nylon cord cutter head.

This manual provides the information necessary for assembly, adjustment, operation and maintenance of your unit. A spare parts listing is also provided, and parts are readily available by following the instructions as detailed on the back page of this manual.

SAFETY INSTRUCTIONS

1. Do Not operate the unit when you are fatigued.
2. Do Not operate if other people or animals are in the work area.
3. Do Not operate the unit without the shield correctly in position.
4. Do Not operate in a confined area. Carbon monoxide exhaust gas is highly poisonous.
5. Do Not operate the unit while you are smoking.
6. Always wear eye protection goggles when operating the unit.
7. Always hold the unit firmly with both hands and with fingers and thumbs encircling the handles.
8. Always obey local ordinances regulating the use of internal combustion engines in your area.
9. Always use the cutting attachments as approved and supplied by ECHO Inc. for your unit.
10. Always remain alert when operating the unit to avoid possible injury to yourself and other people.

WARNING-DANGER

1. Do Not smoke while handling gasoline.
2. Do Not refuel a hot engine. Wait until it cools.
3. Do Not overfill the tank. Spilled fuel must be wiped up.
4. Always stop the engine when refueling.
5. Always remove the fuel cap slowly in order to relieve any pressure build up in the tank.
6. Always restart the engine at least 10 feet away from the refueling point.
7. Always store gasoline in an approved container.

CONTENTS

	Page
Safety Instructions	1
Technical Data	2
Nomenclature of Parts	3
Assembling	3
Nylon Cord Cutter Head	5
● Installation	5
● Adjustment	5
● Replacement	6
Operation	7
Maintenance and Care	10
Trorage Shooting	12
Storage After Use	13
Parts Catalogue	14

TECHNICAL DATA

		GT-140 B	GT-160	GT-200 A
Dimension	LxWxH	cm (in.)	147x17x37 (57.9x6.7x14.6) 147x19x37 (57.9x7.5x14.6)	
Weight		kg (lbs)	4.8 (10.6) : w/o cutter head 5.0 (11.0) : w/o cutter head	
Engine	Type		Air cooled two stroke single cylinder	
	Displacement	cc (cu.in.)	13.8 (0.84)	16.0 (0.97)
	Max. revolution	rpm	6500	7000
	Carburetor		Walbro diaphragm type WA	
	Ignition		Flywheel magneto: Contact breaker point system	
	Spark plug		NGK BM6A	
	Starter		Recoil starter	
	Clutch		Automatic centrifugal clutch	
Fuel	Mixing ratio		Mixture of regular gasoline and air cooled two stroke engine oil. (20:1 Ratio or 32:1 Ratio with special oil approved by ECHO)	
	Tank capacity	litre (FL.OZ.US)	0.25 (8.5)	0.5 (16.9)
Drive shaft ass'y	Cutter (Nylon cord cutter head)		Manual	Semi-automatic
			Cutting swath 14 in.	Cutting swath 16 in.
	Bearing		Two Ball Bearings	
	Rotation		Clockwise	
	Lubrication		Shell Delpena or good quality lithium based grease	
	Drive shaft		Flexible high tensile steel	
	Shield		Plastic shield mounted on the bearing housing (with replaceable cut-off knife)	

Technical data subject change without notice.

NOMENCLATURE OF PARTS

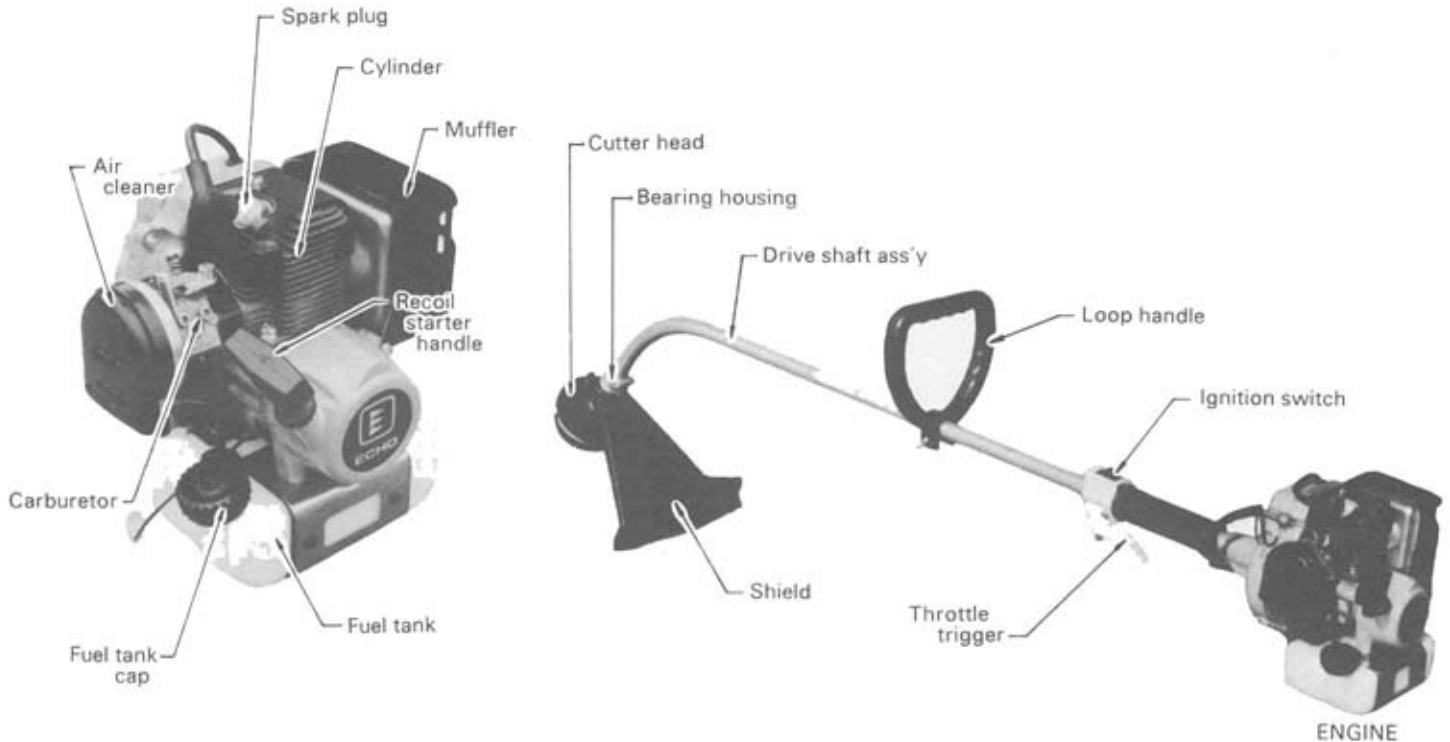

ASSEMBLING

DRIVE SHAFT

- Stand engine upright on a level floor.
- Loosen bolt at drive shaft end of the engine.
- Fit drive shaft assembly ensuring that the drive shaft is correctly engaged.
- The line on drive shaft housing must be in contact with the engine.
- Rotate drive shaft housing until gear housing is in line with the engine.
- Tighten bolt to fasten drive shaft ass'y.

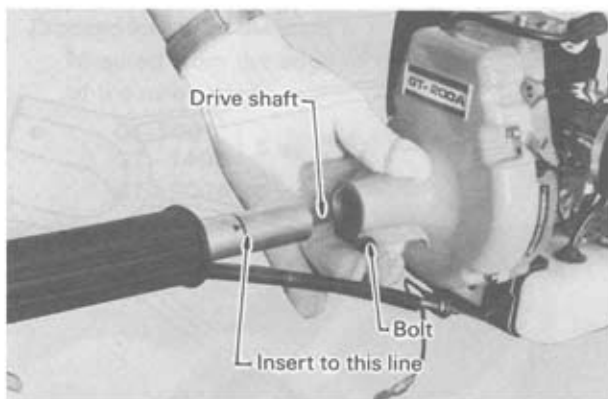

THROTTLE CABLE

As the engine is delivered with throttle cable (engine side) separated, assemble the cable to carburetor as follows.

- Remove nut (A) and one washer from throttle cable.
- Fit the terminal of the ignition switch wire (ground lead) on the cable adjuster before following steps.
- Insert throttle cable through the hole of fancover as shown.
- Replace nut (A) finger tight, and attach the inner cable to swivel on throttle lever ensuring that the nipple fits into socket provided on one side of slot.
- Tighten nut (A) to secure in this position.
- Check that throttle operates freely and returns to idle position.
- Do not loosen nut (B) unnecessarily, since it has been located properly at the factory.

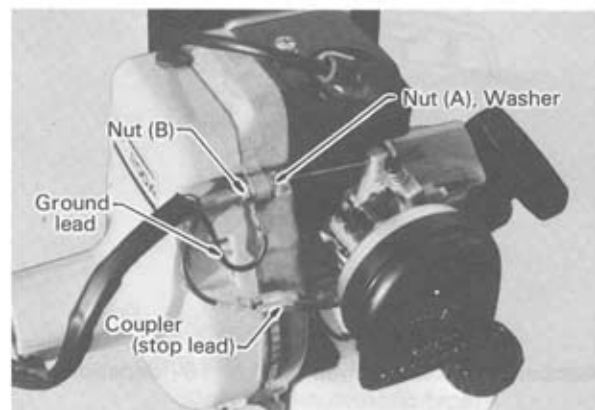

- Connect WIRE from ignition switch to coupler on engine.

LOOP HANDLE

- Remove the wing nut and bolt from the loop handle.
 - Push the handle over the drive shaft approximately 6-8 inches from the grip.
 - Adjust location of the handle to a convenient operating position.
- Secure in position with the bolt and wing nut.

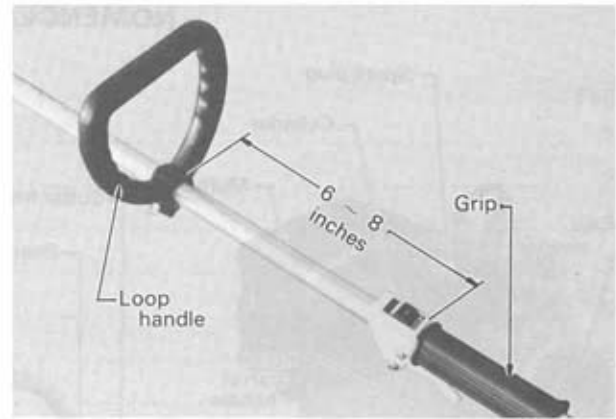

SHIELD (with cut-off knife)

- Remove the wing nut and bolt from the shield.
- Install the shield on the bearing housing as shown.
- Fit the bolt and tighten the wing nut by hand.

(NOTE) LOCATION of THE CUT-OFF KNIFE should be altered depending on the model as illustrated. (Remove both nuts and cut-off knife and set it as required.)

- The knife will normally cut the nylon cord to the required length.

(CAUTION)

DO NOT operate trimmer without shield in correct position.

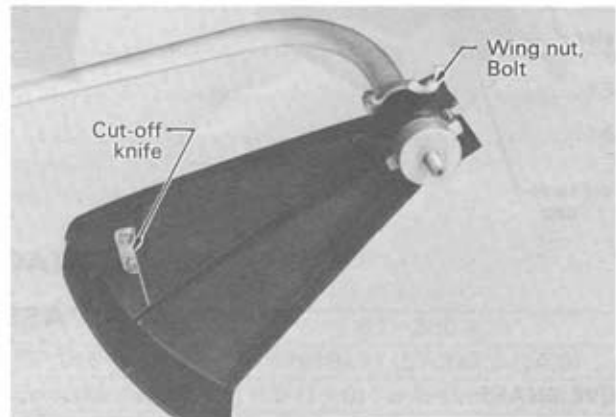

LOCATION OF THE CUT-OFF KNIFE

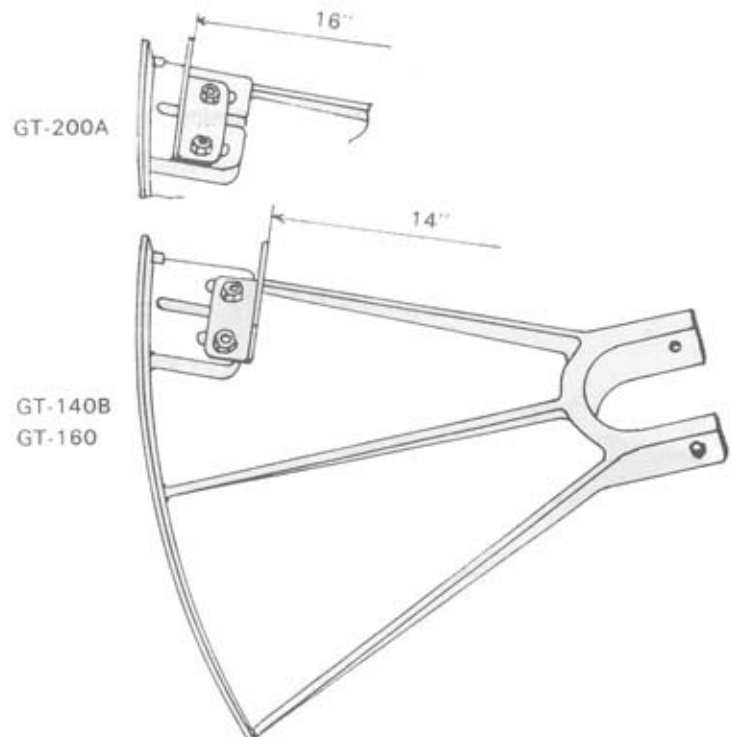

* Numbers in the illustration (14" or 16" depending on model) indicate normal operating width (swath).

NYLON CORD CUTTER HEAD (Semi-automatic)

INSTALLATION

Install the nylon cord cutter head to the shaft as follows.

- Rotate the drive shaft until the holes in the fixing plate and bearing housing are aligned.
- Insert locking tool into the hole.
- Screw the cutter head on the drive shaft. (Rotate the head CLOCK-WISE to tighten.)
- Remove locking tool.

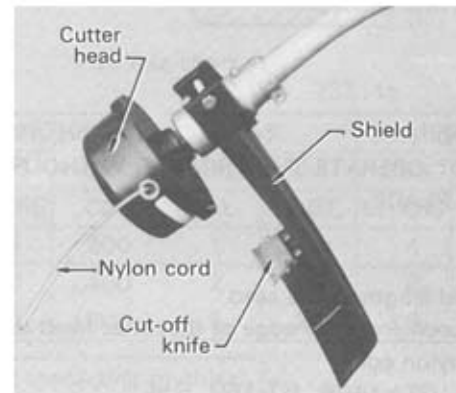
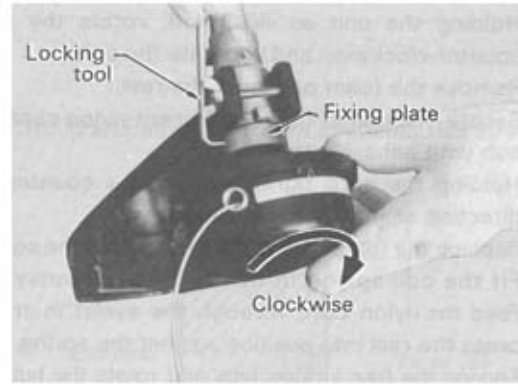

ADJUSTMENT

In service, the cord will fray at the end and eventually become too short for satisfactory use.

Semi-automatic cutter head feeds replacement cord without stopping the engine.

- TO ADJUST the length of the cord, simply tap the head firmly on the ground at normal operating speed.
- One inch of cord will feed each time the head is operated.
- Location of the cut-off knife (Attached on the shield) should be altered depending on the models.
- For location of the cut-off knife, refer to installation of the shield, page 4.

Exposed length of the cord

: Measured from the edge of the cutter head to the tip of the nylon cord.

GT-160 } 5 in.
GT-140B }
GT-200A } 6 in.

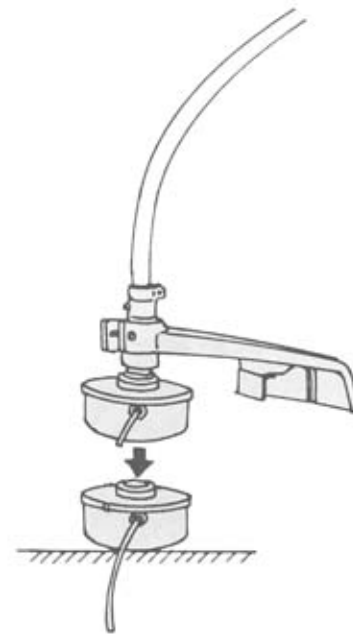
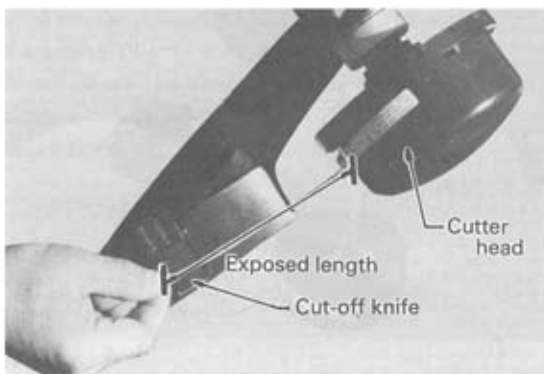

TAP THE CUTTER HEAD ON THE GROUND AT OPERATING SPEED
(Only semi-automatic type)

CAUTION: STOP THE ENGINE BEFORE HANDLING THE CUTTER HEAD.

REPLACEMENT OF THE NYLON CORD

- Remove the cotter pin. (A)
- Holding the unit as illustrated, rotate the right hand counter-clockwise and separate the unit. (B)
- Remove the foam pad from the reel. (C)
- Secure one end of the replacement nylon cord to the reel hub with adhesive tape. (D)
- Holding the cord tight, wind it in a counter-clockwise direction as indicated by the arrow. (E)
- Replace the foam pad in the reel to hold the cord in place. (E)
- Fit the coil spring in the hub if previously removed. Feed the nylon cord through the eyelet in the hub and press the reel into position against the spring.
- Engage the four locking tabs and rotate the hub clockwise, to lock in position.
- Install a new cotter pin.

(CAUTION)

- DO NOT OPERATE THE TRIMMER WITHOUT COTTER PIN IN PLACE

-
- Exposed length of the cord
: Measured from the edge of the cutter head to the tip of the nylon cord.

GT-140B, GT-160 5 in.

GT-200A 6 in.

(NOTE)

- For location of the cut-off knife, refer to installation of the shield, page 4.

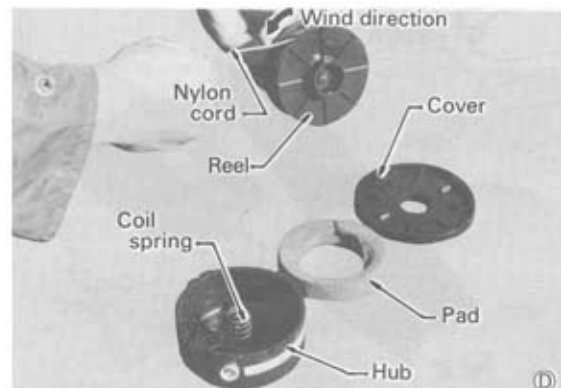
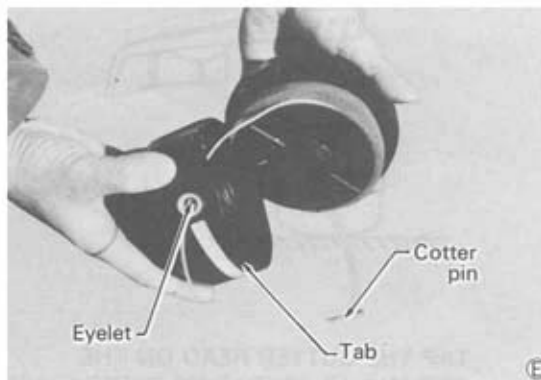
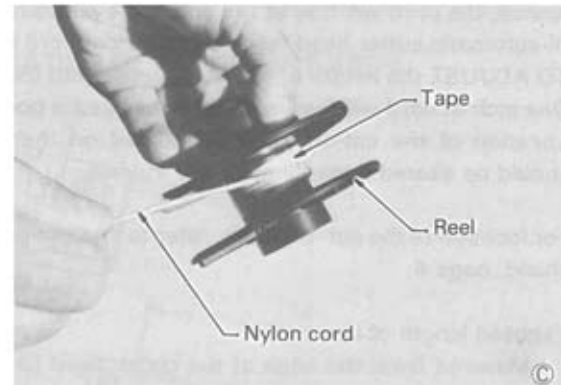
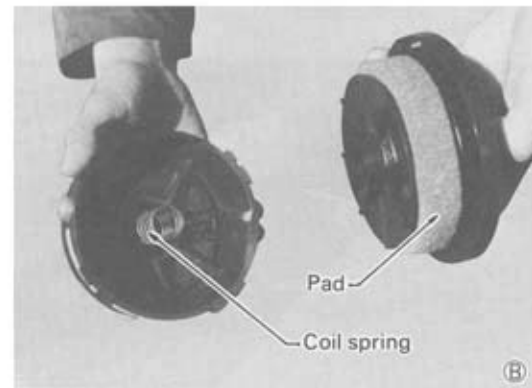
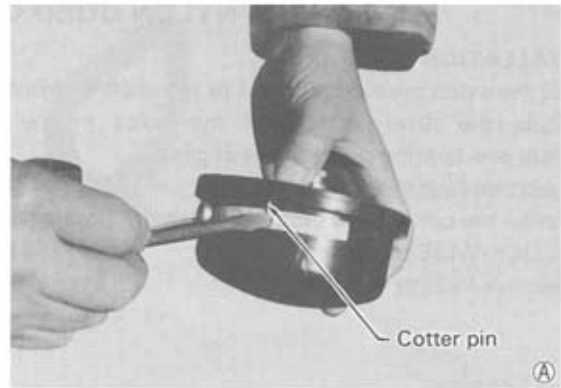

OPERATION

- Check for loose nuts, bolts and screws before using the unit every use.

FUEL

- Fuel used for this model is a mixture of regular grade gasoline and ECHO brand motor oil or an aircooled two stroke engine oil of a reputable brand name.
- Mixture ratio is
Gasoline 20 parts: Oil 1 part.
 - Fuel mixture at a rate other than 20:1 may cause malfunction of the engine.
 - Pour 1/2 of the gasoline into a safe container, add oil and mix thoroughly.
 - Now add the remainder of gasoline and mix again.
 - Do not use motor oil other than that recommended above.
 - Do not mix directly in engine fuel tank.
- After refueling, secure the fuel tank cap and wipe all spilled fuel with a dry cloth.

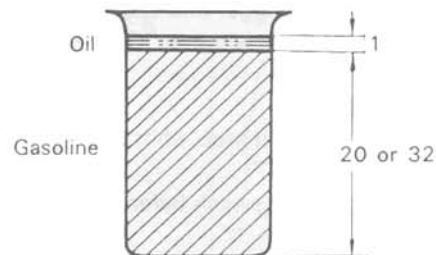

Fuel mix chart

(20 : 1)				(32 : 1)			
US		METRIC		US		METRIC	
GAS	OIL	GAS	OIL	GAL	OIL	GAS	OIL
GAL.	FL.OZ.	LITERS	CC	GAL.	FL.OZ.	LITERS	CC
1	6.4	4	200	1	4	4	125
2	12.8	8	400	2	8	8	250
5	32.0	20	1000	5	20	20	625

(NOTE)

32:1 Ratio is applicable with special oil approved by ECHO.

STARTING

Before starting the engine, make sure that the cutter head is not contacting anything. Do not allow people into the starting area.

STARTING COLD ENGINE

- Slide ignition switch to START/RUN position as shown. (FORWARD) Turn choke lever to START (Close) position.
- Squeeze throttle trigger slightly and pull starter handle several times until first firing sound. Now, turn choke lever to RUN (Open) position, and if necessary, restart the engine.
- When engine has been started, release throttle trigger and allow to warm up for a few minutes before using.
- After idling, gradually squeeze throttle trigger and cutter head will start to operate as the engine attains clutch engagement speed of 3000 RPM approximately.

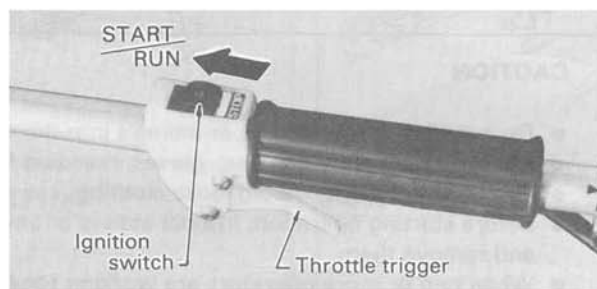

(NOTE)

Recoil starter: Use short pulls—only 1/2–2/3 of starter rope for starting.

Do not allow the starter handle to snap back against the casing.

Always hold the unit firmly.

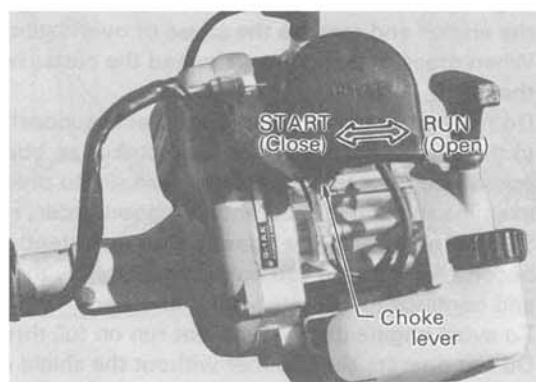

CAUTION: DO NOT RUN THE ENGINE ON FULL THROTTLE WITHOUT CUTTER HEAD TO AVOID ENGINE DAMAGE

STARTING WARM ENGINE

- When engine is warm, start it by pulling recoil starter rope with switch positioned at START/RUN. (Keep choke lever in RUN (Open) position.)
- If engine does not start in a few tries, follow same procedures as to start cold engine.

STOPPING ENGINE

- Release throttle trigger and allow to run at an idle speed.
- Slide back ignition switch to "STOP" position.

(NOTE)

When engine does not stop, shift choke lever to close position.

Check and repair stop switch before starting the engine again.

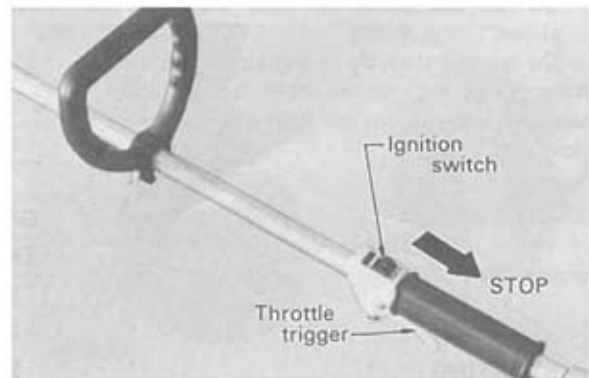

GENERAL TRIMMING INSTRUCTIONS

Prior to using your trimmer, familiarize with the safety instructions listed in the Operator's Manual, and all local regulations for the operation of your unit. These instructions and regulations are for the protection of the operator.

For all types of operations, always hold the trimmer securely with both hands, with thumbs and fingers encircling handle and grip.

CAUTION

- Do not allow either people or animals into the work area.
 - Always wear safety goggles, gloves, non-skid foot wear.
 - DRESS PROPERLY—Avoid loose clothing.
 - Before starting operation, inspect stones or any other foreign object(Can, bottle, steel wire etc.) in the area and remove them.
 - When two or more operators are working together, ensure that a safe distance is kept between them.
 - Keep both hands on the grips when power is on.
 - Engine continues running even when cutter head has stopped due to an excessive load. In such cases, stop the engine and remove the cause of overloaded before again starting the engine and resuming the job.
 - When grass or weed have clogged the cutter head affecting normal operation, first, stop the engine and remove them.
 - Do not overreach or stand on unstable support.
 - In the event, that the cutter head strikes an obstruction, or is otherwise prevented from rotating in normal operation, the centrifugal clutch will slip to prevent engine damage. In this case, stop the engine free and examine the cutter head and if in good order, resume operation.
 - Should the trimmer be operated for an extended period in high temperatures, the drive shaft housing may become very hot. If too hot to touch, allow the unit to cool down, check the lubrication as per 'Maintenance' and continue to operate irate if in order.
 - To avoid engine damage, do not run on full throttle without load.
 - Do not operate the trimmer without the shield correctly fitted.
 - Always inspect the work area and remove any foreign objects.
- READ CAREFULLY SAFETY INSTRUCTION (Page 1).

For most cutting and trimming jobs, 13 ~ 15 cm (five ~ six inches) of cord (measured from the edge of the cutting head to the tip of the cutting cord) is recommended. Remember that cutting is done with the tip of the cord.

Do not attempt to cut with the entire length of the cord. This will result in the cord snapping or fraying, thereby reducing the cutting efficiency and also will result in using more cord than necessary.

※Length of cord depends on the models. Refer to page 4 and 5.

CUTTING PROCESURES

Place the trimmer with the cutter head facing straight ahead. Always trim from the right to the left tilting the unit slightly to the right allowing the debris to be thrown away from the operator.

(CAUTION)

Letting the cutter head tilt to the left will result in debris being thrown back towards the operator. (SEE ILLUSTRATIONS A and B)

SCALPING

Scalping is the removal of all vegetation down to the ground. For this operation, tilt the cutter head about 30°. Ensure the head is tilted to the right. (SEE ILLUSTRATION C)

Scalping around trees and bushes is particularly effective, but care should be exercised not to bruise the bark of young and sensitive growth.

In flower beds, always remember that the nylon cord will cut in a complete circle to avoid cutting flowers instead of weeds.

EDGING

Tilt the cutter head to a vertical position. Allow the nylon cord to skim along the edge of the concrete. Adjust the handle bracket so that this can be done with the least amount of effort. (SEE ILLUSTRATION D)

SWEEPING

For clearing driveways, sidewalks, etc. of grass and other debris, tilt the cutter head slightly to the right, then swing from side to side. (SEE ILLUSTRATION E)

MOWING

Swing the trimmer from side to side while keeping the cutter head level. During this operation, debris may be thrown in any direction. Safety glasses or a face shield is necessary. (SEE ILLUSTRATION F)

CUTTING PROCESURES

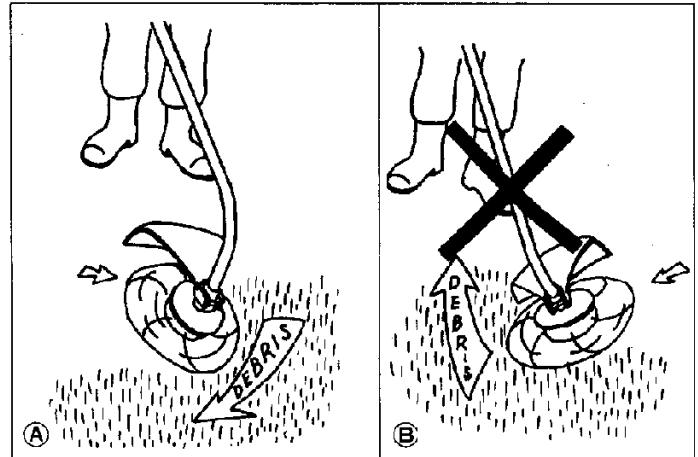

SCALPING

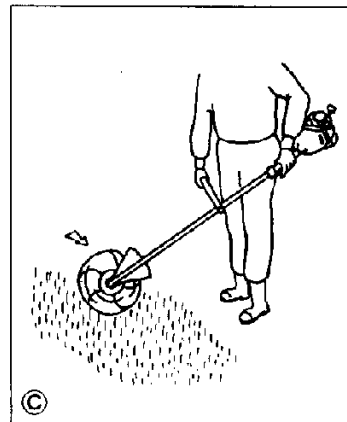

EDGING

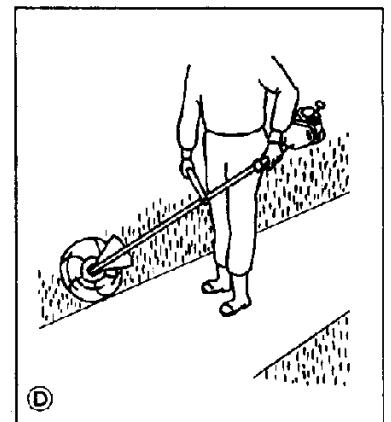

SWEEPING

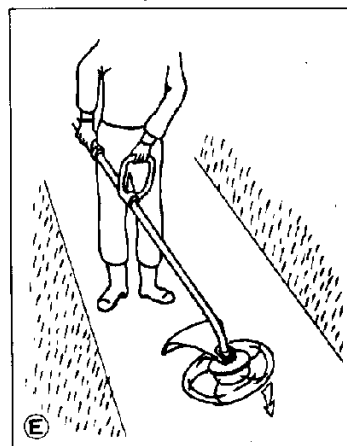

MOWING



MAINTENANCE AND CARE

=ALWAYS KEEP THE UNIT CLEAN=

AIR FILTER

- Clean every day.
 - Remove air cleaner cover with filter.
 - Brush off dust lightly or wash it in a non-inflammable solvent.
 - When you wash it in a solvent, dry it completely before putting back in place.



FUEL STRAINER

- Check periodically.
 - Do not allow dust to enter fuel tank.
 - Clogged strainer will cause difficulty in starting engine or abnormalities in engine performances.
 - Pick up fuel strainer through fuel inlet port with a piece of steel wire or the like.
 - When strainer is dirty, wash it in gasoline.

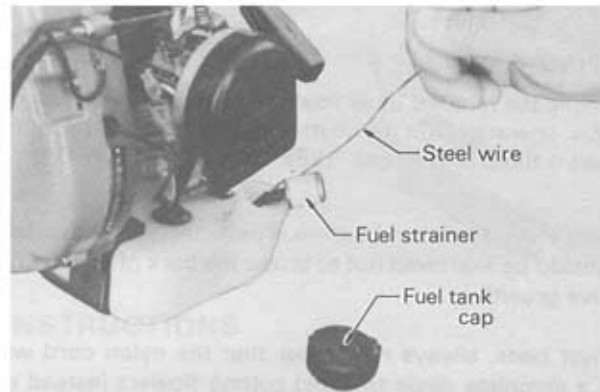

FUEL TANK CAP

- Fuel tank cap is fitted with a check valve which allows air into the tank as fuel is consumed.
- Always clean the air vent and filter of the tank cap to prevent reducing of the engine performance.

SPARK PLUG

- Check periodically.
- Standard spark gap is 0.6–0.7 mm (0.024–0.028 in.)
- Replace if either electrode is worn or if the insulator is fouled by oil or other deposits.
- TORQUE - 145–155 kg-cm (125–135 in. lb)

CAUTION
Do not over torque.



DRIVE SHAFT (Flexible shaft)

- Entire surface of the flexible shaft should be properly greased. (It has been greased at the time of shipment from the factory.)
- We recommend lubricating and reversing (rotating) the drive shaft, and grease up it as follows.
 - Loosen screw and bolt of the bearing housing and remove it.
 - Pull the flexible shaft from the drive shaft tube.
 - Wipe clean and recoat the shaft with a thin coating (15–20g) of lithium base grease such as EP-2.
 - Install the shaft in reverse procedures above.

(NOTE)

Check every 50 hours of actual use.

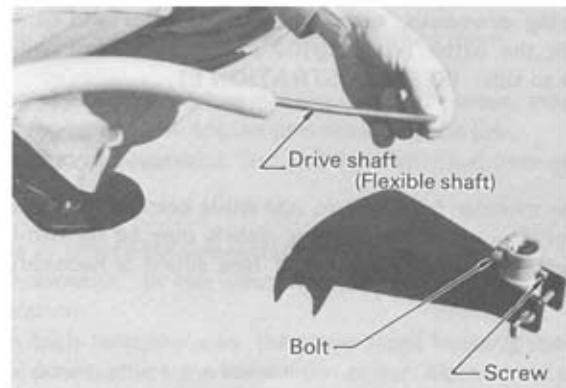

CARBURETOR

- Carburetor is set at the factory. So normally, further adjustment is unnecessary. If readjustment is required, refer to the following instructions.

CARBURETOR ADJUSTMENT

The diaphragm carburetor has three external adjustments, and to some extent, the adjustment of each will affect the other two. It will be necessary, therefore, to readjust each until satisfactory performance is achieved.

1. Idle speed adjusting screw.

This adjustment controls the throttle opening in the idle position.

2. Low (LO) speed needle screw.

The low speed needle controls the volume of fuel/oil mixture at low engine speed. It also controls the supplementary fuel required to obtain smooth progression from idling to high speed.

3. High (HI) speed needle screw.

The high speed needle controls the volume of fuel/oil mixture at full throttle opening.

Turn both 'HI' and 'LO' needles clockwise until fully closed.

Do not use excessive force

Unscrew the 'LO' needle one complete turn.

Turn the idle speed adjustment screw clockwise until the throttle is slightly open.

Start the engine and run for a few minutes on high idle until the engine is warm. Allow the engine to idle, and if necessary, readjust the idle speed screw to keep the engine from stalling.

'LO' SPEED ADJUSTMENT

Turn the 'LO' needle clockwise slowly and note the position at which the engine speed is reduced. Now turn the 'LO' needle counterclockwise and again note the position when speed is reduced. Set the needle in the midway position. Finally, adjust the engine idling speed by turning the idle speed screw in a clockwise direction until the clutch just begins to engage. This indicates a speed of 3000–3400 RPM. Now reduce engine speed by turning the screw counterclockwise one half turn.

MUFFLER AND EXHAUST PORT

- Clean as necessary.
- Carbon deposit in cylinder exhaust port and muffler will reduce engine output.
 - Muffler can be removed by taking off muffler cover.
 - Be careful not to scratch cylinder or piston when cleaning cylinder exhaust port.
 - Clean the spark arrester screen too.

CYLINDER FINS

- Check periodically.
- Clogged fins will result in poor engine cooling.
- Remove dirt and dust from between fins to let cooling air pass easily.

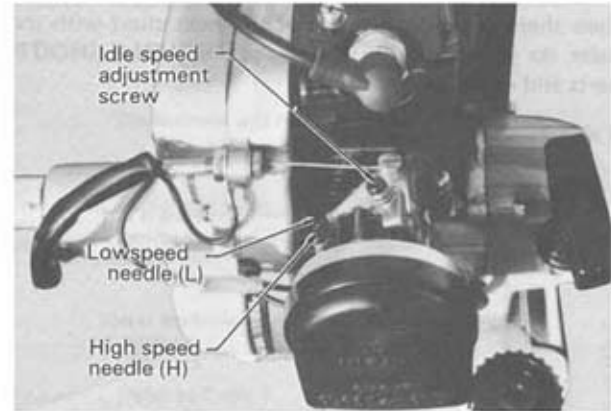

'HI' SPEED ADJUSTMENT

Engine must be at normal operating temperature.

Turn the 'HI' needle counterclockwise 1-1/4 turns.

Run the engine at full throttle and turn the 'HI' needle slowly clockwise until the engine runs smoothly without "four stroking" on no load.

Turn the needle open again (counterclockwise) 1/8 turn to obtain optimum fuel for full power under load conditions.

CAUTION

DO NOT RUN THE ENGINE ON FULL THROTTLE LONGER THAN 5-6 SECONDS TO AVOID DAMAGE TO ENGINE.

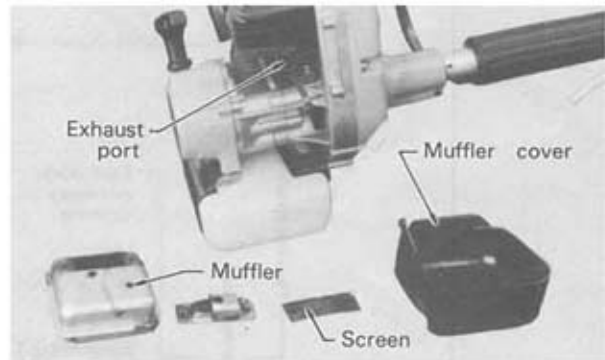

TROUBLE SHOOTING

Poor performance of the engine and/or trimming mechanism can normally be prevented by carefully following the above instructions.

Poor performances can easily be corrected even by a beginner.

When the engine does not function properly check the following three (3) positions first.

- Is engine compression adequate?
- Is fuel system in good condition and is enough fuel being supplied?
- Is electrical system in good condition and is spark plug operating normally?

When there is serious trouble of the next chart with the unit, do not try to repair it yourself but have your distributor or dealer do it for you. For detailed **TROUBLE SHOOTING** refer to tables 1 and 2. Locate the problem on the following charts and repair as necessary.

Table 1

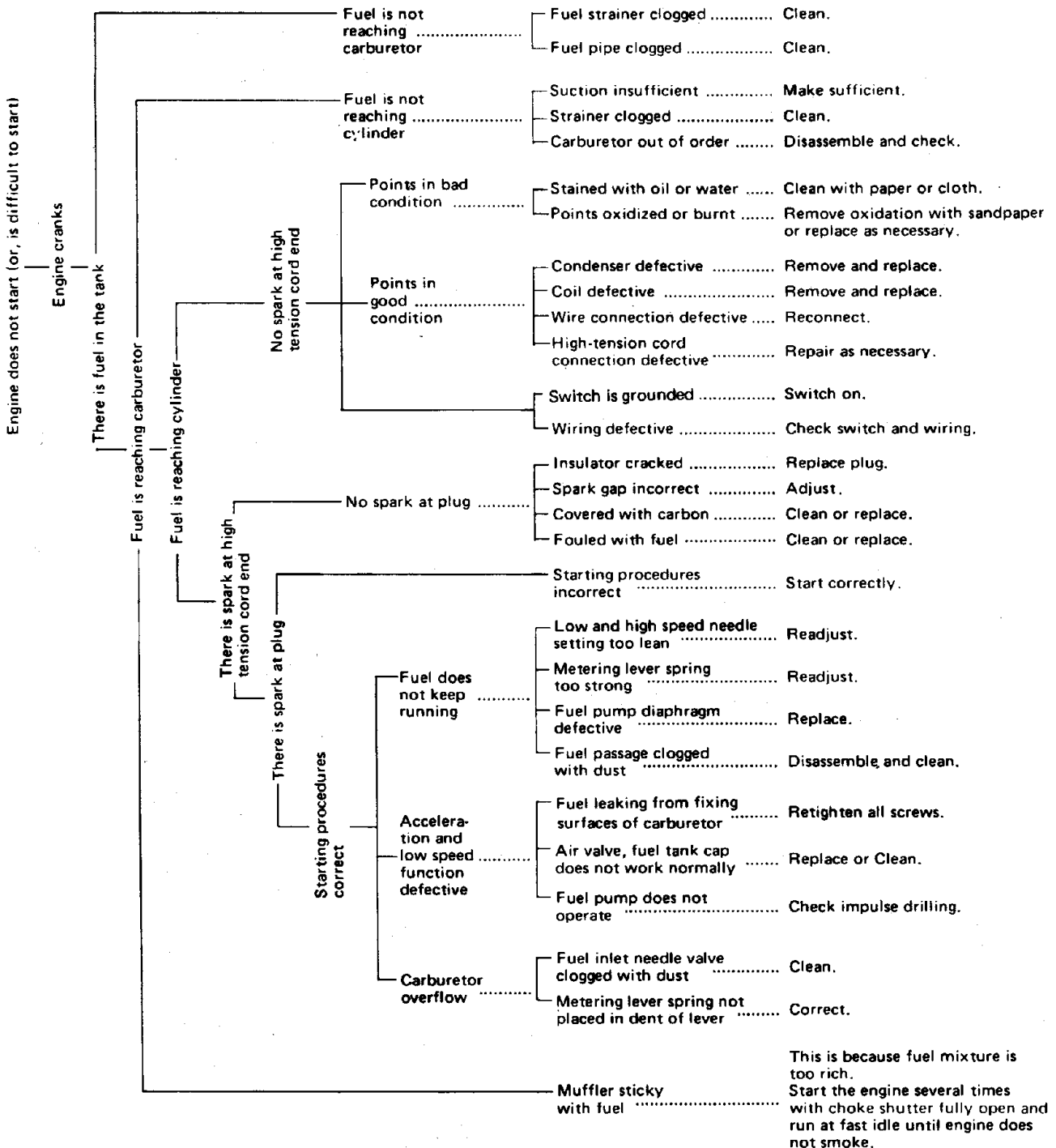
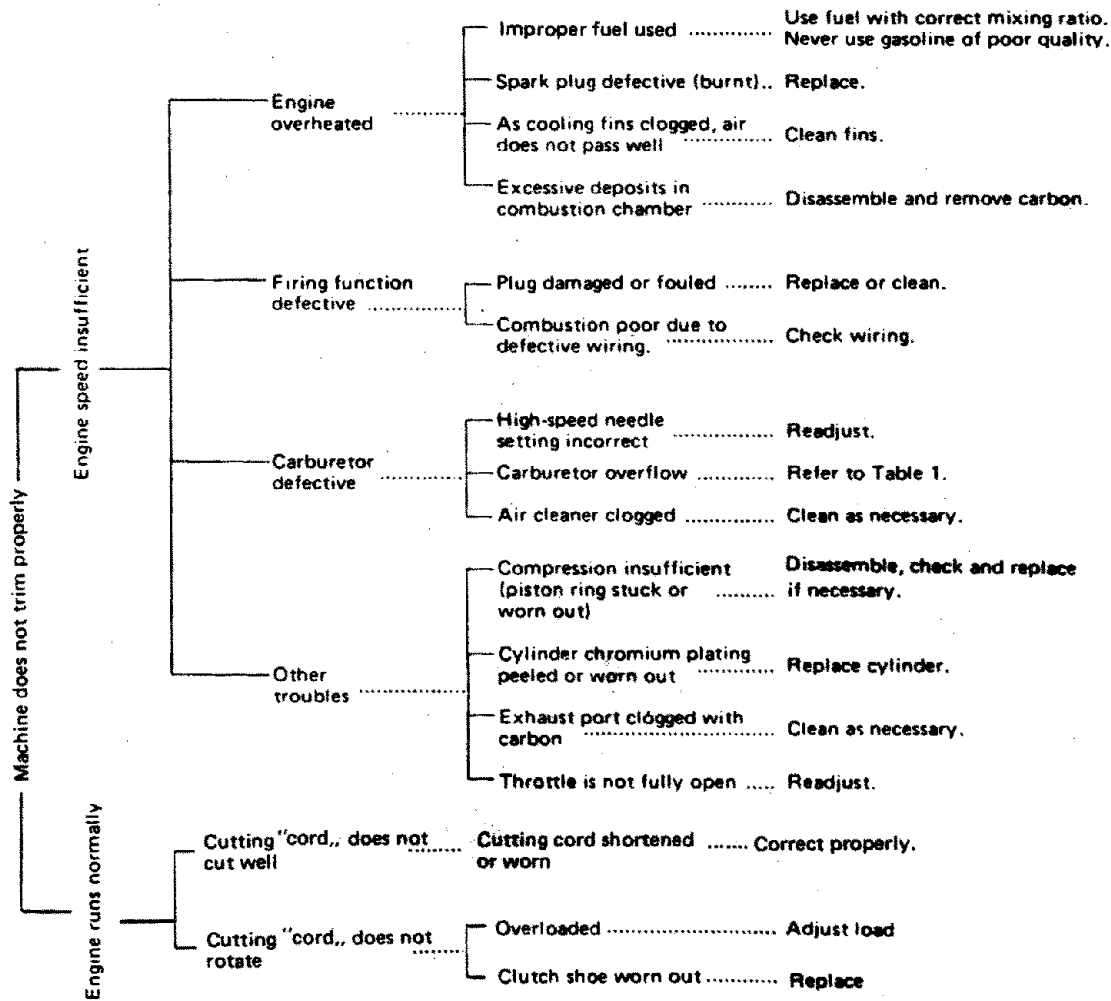

Table 2



STORAGE AFTER USE

- Inspect and adjust every part of the unit.
 - Completely clean every part, and repair, if necessary.
 - Apply thin coating of oil on metal parts to prevent rust.
 - Remove the cutter head, apply sufficient oil coating and wrap up in plastic.
- Drain fuel tank, pull starter handle slowly a few times to drain fuel from carburetor.
- Pour a small amount of clean motor oil into spark plug hole, pull starter handle and then crank the engine until TOP DEAD CENTER.
- Store in a dry area, free from dust.

Free Manuals Download Website

<http://myh66.com>

<http://usermanuals.us>

<http://www.somanuals.com>

<http://www.4manuals.cc>

<http://www.manual-lib.com>

<http://www.404manual.com>

<http://www.luxmanual.com>

<http://aubethermostatmanual.com>

Golf course search by state

<http://golfingnear.com>

Email search by domain

<http://emailbydomain.com>

Auto manuals search

<http://auto.somanuals.com>

TV manuals search

<http://tv.somanuals.com>