



Grass Trimmer/Brush Cutter

Operator's Manual

MODELS, Type 1E

SRM - 2100SB

Serial Number 0508702 - 0533423

SRM - 2400SB

Serial Number 0504696 - 0563000



WARNING



The engine exhaust from this product contains chemicals known to the State of California to cause cancer, birth defects or other reproductive harm.

WARNING DANGER

Read rules for safe operation and instructions carefully. ECHO provides an Operator's Manual and a Safety Manual. Both must be read and understood for proper and safe operation.

INTRODUCTION

Welcome to the ECHO family. This ECHO product was designed and manufactured to provide long life and on-the-job-dependability. Read and understand this manual and the SAFETY MANUAL you found in the same package. You will find both easy to use and full of helpful operating tips and SAFETY messages.

WARNING DANGER

Read rules for safe operation and instructions carefully. ECHO provides an Operator's Manual and a Safety Manual. Both must be read and understood for proper and safe operation.

THE OPERATOR'S MANUAL —

contains specifications and information for operation, starting, stopping, maintenance, storage and assembly specific to this product.

THE SAFETY MANUAL —

explains possible hazards involved with the use of Grass Trimmers and Brush Cutters and what measures you should take to insure safe operation.

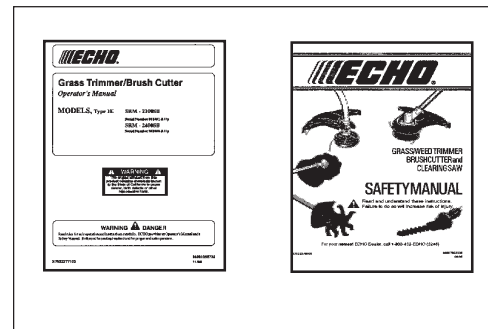



TABLE OF CONTENTS

Introduction	2	Operation	21
- The Operator's Manual	2	- Starting Cold Engine	21
- The Safety manual	2	- Starting Warm Engine	22
Manual Safety Symbols & Important Information	3	- Stopping Engine	23
Safety	3	Maintenance	23
- General Description	3	- Skill Levels	23
- Decals	4	- Maintenance Intervals	24
- International Symbols	5	- Air Filter	25
- Equipment	5	- Fuel Filter	25
- Fuel	6	- Spark Plug	26
- Personal Condition & Safety Equipment	6	- Cooling System Cleaning	26
- Safe Operation	8	- Exhaust System	27
- Extended Operation/Extreme Conditions	9	- Carburetor Adjustment SRM-2100SB	28
Description	10	- Carburetor Adjustment SRM-2400SB	29
- Contents	10	- Lubrication	29
- Blade Terms & Definitions	10	- Nylon Line Replacement	31
- Emission Control	11	- Sharpening Metal Blades	32
Specifications	13	Troubleshooting	33
Assembly	14	Storage	34
- ECHO Approved Optional Equipment	14	Servicing Information	36
- Power Head Shaft / Lower Shaft Assembly	15	- Parts	36
- Plastic Shield Installation	15	- Service	36
- Nylon Head Installation	16	- ECHO Consumer Product Support	36
- Front Handle Installation	16	- Warranty Card	36
Pre-Operation	17	- Additional or Replacement Manuals	36
- Operation with Blades	17	- Manual Ordering Instructions	36
- Fuel	19		
- Equipment Check	20		
- Determine Operation Area	20		

Specifications, descriptions and illustrative material in this literature are as accurate as known at the time of publication, but are subject to change without notice. Illustrations may include optional equipment and accessories, and may not include all standard equipment.

MANUAL SAFETY SYMBOLS AND IMPORTANT INFORMATION

Throughout this manual and on the product itself, you will find safety alerts and helpful, information messages preceded by symbols or key words. The following is an explanation of those symbols and key words and what they mean to you.

 This symbol accompanied by the words **WARNING** and **DANGER** calls attention to an act or condition that can lead to serious personal injury to operator and bystanders.

 The circle with the slash symbol means whatever is shown within the circle is prohibited.

 **IMPORTANT**  **NOTE**

IMPORTANT The enclosed message provides information necessary for the protection of the unit.

NOTE This enclosed message provides tips for use, care and maintenance of the unit.

SAFETY

GENERAL DESCRIPTION

IMPORTANT
See Description and Specification sections for full description and illustration of model variation in power head, handle type, harness and debris shield/cutter head.

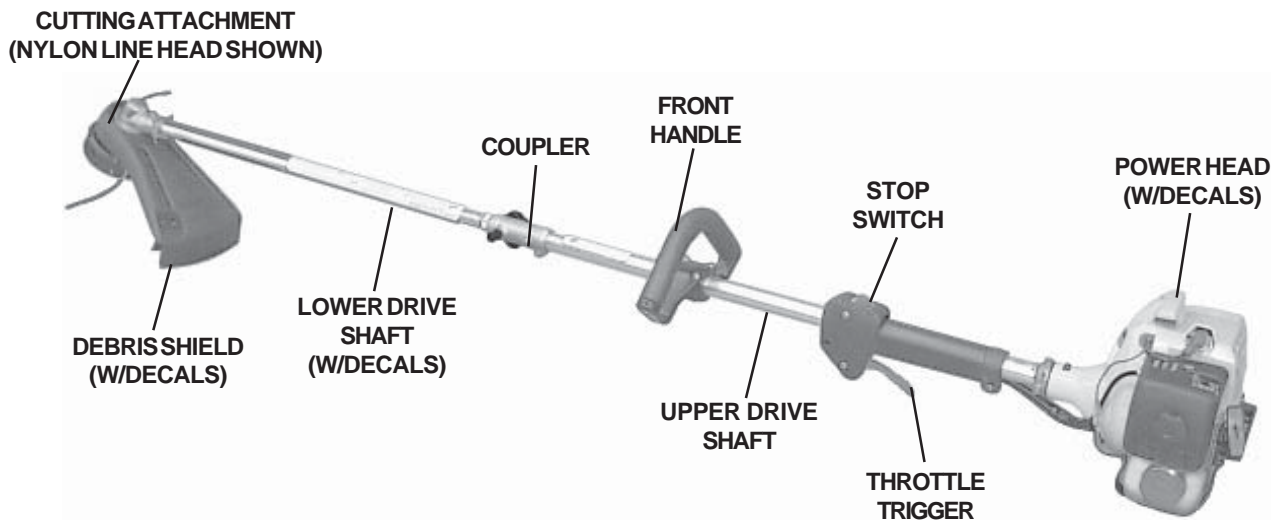

DECALS

Locate these safety decals on your unit. The complete unit illustration, found in the "DESCRIPTION" section, will help you locate them. Make sure the decals are legible and that you understand and follow the instructions on them. If a decal cannot be read, a new one can be ordered from your ECHO dealer. See PARTS ORDERING instructions for specific information.

Shaft Decal



- This unit can be dangerous and cause serious injury if improperly used. To reduce injury risk to operator, helpers and bystanders, read and understand the Operator's and Safety manuals.
- Blindness can occur from objects that are thrown or ricocheted even with shield in place. Operators, helpers and bystanders must wear ANSI Z87.1 approved eye protection.
- Always wear hearing protection when operating unit.
- Prevent accidental contact with unit and any cutting attachment. Maintain a 15M (50 ft.) radius, **DANGER ZONE** surrounding the operator. **ONLY** the operator, dressed in proper protective clothing should be in the **DANGER ZONE**.
- Beware of **KICKOUT (blade thrust)** when using blades. Special precautions are necessary for blade operation, see your Operator's and Safety Manuals. **ONLY** install ECHO approved blades on Brush Cutters (SRM) models equipped with proper blade shield, U-handles, harness, blade collar, nut and cotter pin.
- Blade/Cutting attachment does not stop immediately after releasing throttle. Keep hands and feet clear of blade/cutting attachment unless engine is shut off and cutting attachment is not moving.
- **INSPECT BLADES BEFORE USE.**
- **DO NOT USE DAMAGED, CRACKED, BENT, DULL OR IMPROPERLY SHARPENED BLADES.**
- Do not remove shields, modify the unit or install attachments or parts not approved by ECHO. Approved attachment information and replacement Operator's and Safety Manuals are available from your ECHO dealer or by writing: **ECHO, INCORPORATED, 400 OAKWOOD RD., LAKE ZURICH, IL 60047.**

DEBRIS SHIELD DECAL

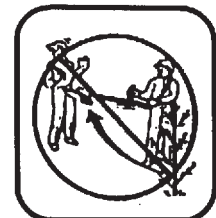
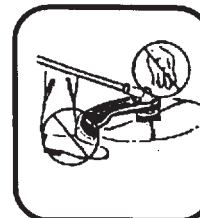
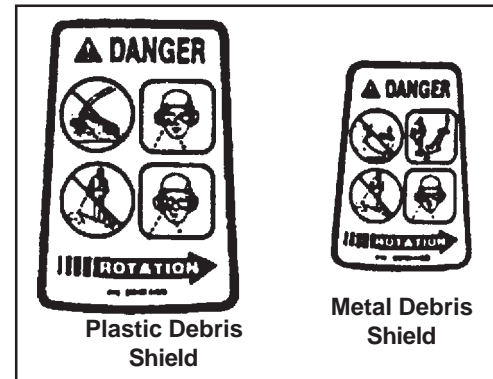

INTERNATIONAL SYMBOLS

Symbol form/shape	Symbol description/application	Symbol form/shape	Symbol description/application
	Read and understand Operator's Manual.		Fuel and oil mixture
	Wear eyes, ears and head protection		Finger Severing
	Hot Surface		Wear hand protection. Use two handed.
	Safety/Alert		DO NOT smoke near fuel.

Symbol form/shape	Symbol description/application	Symbol form/shape	Symbol description/application
	DO NOT allow flames or sparks near fuel.		Wear slip resistant foot wear.
	Emergency stop		Ignition ON/OFF
	Engine choke control.		Primer bulb
	Carburetor adjustment - High speed mixture		Carburetor adjustment - Low speed mixture
	Carburetor adjustment - Idle speed		

EQUIPMENT

Before operation a complete check of the unit must be performed;

- Check unit for loose/missing nuts, bolts and screws. Tighten and/or replace as needed.
- Inspect fuel lines, tank and area around carburetor for fuel leaks. DO NOT operate unit if leaks are found.
- Inspect shield for damage and ensure that the cut-off knife is securely in place. Replace if either is damaged or missing.
- Check that the cutting attachment is firmly attached and in safe operating condition.
- Check that front handle and shoulder strap/or shoulder/waist harness are adjusted for safe, comfortable operation. See Assembly Section for proper adjustment.



FUEL

WARNING DANGER

Fuel is **VERY** flammable. Use extreme care when mixing, storing or handling or serious personal injury may result.

- Use an approved fuel container.
- DO NOT smoke near fuel.
- DO NOT allow flames or sparks near fuel.
- Fuel tanks/cans may be under pressure. Always loosen fuel caps slowly allowing pressure to equalize.
- NEVER refuel a unit when the engine is HOT!
- NEVER refuel a unit with the engine running.
- DO NOT fill fuel tanks indoors. ALWAYS fill fuel tanks outdoors over bare ground.
- Securely tighten fuel cap after refueling.
- Inspect for fuel leakage. If fuel leakage is found, do not start or operate unit until leakage is repaired.

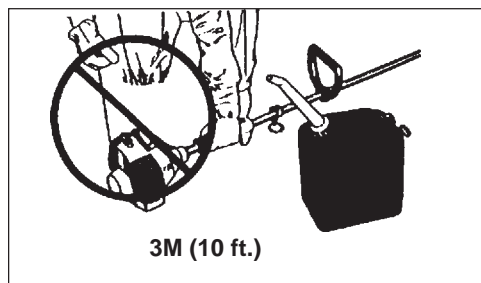

After Refueling;

- Wipe any spilled fuel from the unit.
- Move at least 3 M (10 ft.) from refueling location before starting.

After Use;

- DO NOT store a unit with fuel in its tank. Leaks can occur. Return unused fuel to an approved fuel storage container.

PERSONAL CONDITION & SAFETY EQUIPMENT

WARNING DANGER

Trimmer/Brush Cutter users risk injury to themselves and others if the trimmer/brush cutter is used improperly and or safety precautions are not followed. Proper clothing and safety gear must be worn when operating a trimmer.

Physical Condition --

Your judgment and physical dexterity may not be good:

- if you are tired or sick,
- if you are taking medication,
- if you have taken alcohol or drugs.

Operate unit only if you are physically and mentally well.



Eye Protection --

Wear eye protection that meets ANSI Z87.1 or CE requirements whenever you operate the trimmer.

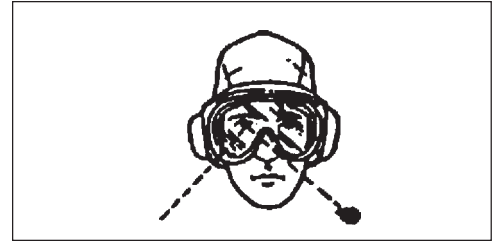

Hand Protection --

Wear no-slip, heavy duty work gloves to improve your grip on the Brush Cutter handles. Gloves also reduce the transmission of machine vibration to your hands.

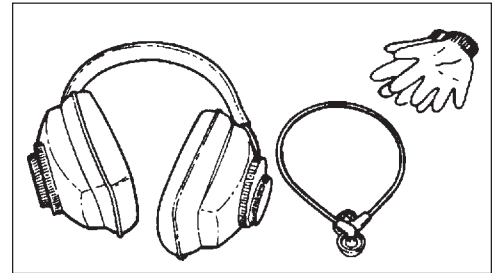

Hearing Protection --

ECHO recommends wearing hearing protection whenever unit is used.



Proper Clothing --

Wear snug fitting, durable clothing;

- Pants should have long legs, shirts with long sleeves.
- DONOT WEAR SHORTS,
- DONOT WEAR TIES, SCARVES, JEWELRY.

Wear sturdy work shoes with non-skid soles;

- DONOT WEAR OPEN TOED SHOES,
- DONOT OPERATE UNIT BAREFOOTED.

Hot Humid Weather --

Heavy protective clothing can increase operator fatigue which may lead to heat stroke. Schedule heavy work for early morning or late afternoon hours when temperatures are cooler.

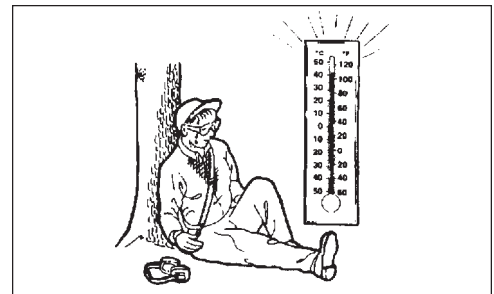

SAFE OPERATION

Determine Operation Area

- Provide all operators of this equipment with the operator's manual and instructions for safe operation.
- Review the area to be trimmed. Look for hazards that could contribute to unsafe conditions.
- Spectators and fellow workers must be warned, and children and animals prevented from coming nearer than 15M (50 ft.) while the trimmer is in use.

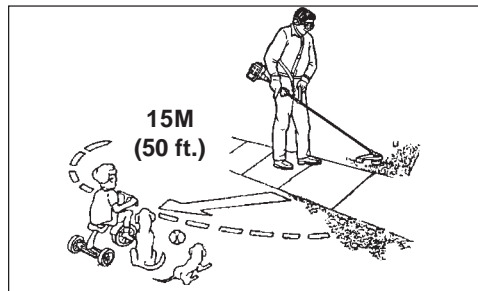

Operation

Use Proper Clothing & Equipment

- Before starting the unit, equip yourself and any other person working within the 15M (50 ft.) Safety Zone with the required Protective Equipment and clothing.

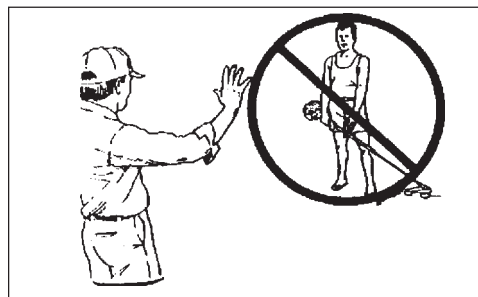

Avoid Hot Surfaces

- During operation, the complete unit, especially the drive shaft housing and the bearing housing may become very hot, too hot to touch. Avoid contact during and immediately after operation.

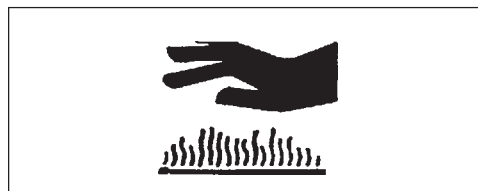

Keep A Firm Grip

- Hold the front and rear handles with both hands with thumbs and fingers encircling the handles.



Keep A Solid Stance

- Maintain footing and balance at all times. Do not stand on slippery, uneven or unstable surfaces. Do not work in odd positions or on ladders. Do not over reach.

EXTENDED OPERATION/EXTREME CONDITIONS

Vibration and Cold --

It is believed that a condition called Raynaud's Phenomenon, which affects the fingers of certain individuals may be brought about by exposure to vibration and cold. Exposure to vibration and cold may cause tingling and burning sensations followed by loss of color and numbness in the fingers. The following precautions are strongly recommended because the minimum exposure which might trigger the ailment is unknown.

- Keep your body warm, especially the head, neck, feet, ankles, hands and wrists.
- Maintain good blood circulation by performing vigorous arm exercises during frequent work breaks and also by not smoking.
- Limit the hours of operation. Try to fill each day with jobs where operating the trimmer or other hand-held power equipment is not required.
- If you experience discomfort, redness and swelling of the fingers followed by whitening and loss of feeling, consult your physician before further exposing yourself to cold and vibration.

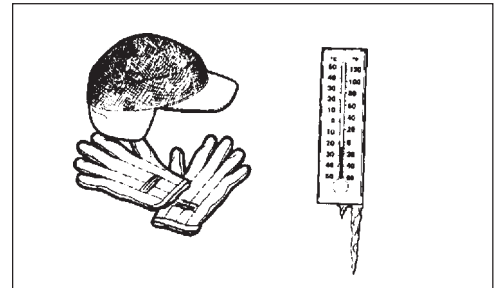

Repetitive Stress Injuries --

It is believed that overusing the muscles and tendons of the fingers, hands, arms and shoulders may cause soreness, swelling, numbness, weakness and extreme pain in those areas. Certain repetitive hand activities may put you at a high risk for developing a Repetitive Stress Injury (RSI). An extreme RSI condition is Carpal Tunnel Syndrome (CTS), which could occur when your wrist swells and squeezes a vital nerve that runs through the area. Some believe that prolonged exposure to vibration may contribute to CTS. CTS can cause severe pain for months or even years. To reduce the risk of RSI/CTS, do the following:

- Avoid using your wrist in a bent, extended or twisted position. Instead try to maintain a straight wrist position. Also, when grasping, use your whole hand, not just the thumb and index finger.
- Take periodic breaks to minimize repetition and rest your hands.
- Reduce the speed and force with which you do the repetitive movement.
- Do exercises to strengthen the hand and arm muscles.
- Immediately stop using all power equipment and consult a doctor if you feel tingling, numbness or pain in the fingers, hands, wrists or arms. The sooner RSI/CTS is diagnosed, the more likely permanent nerve and muscle damage can be prevented.

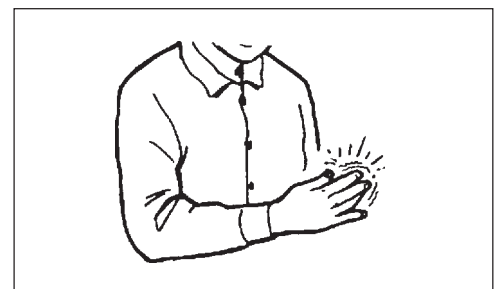
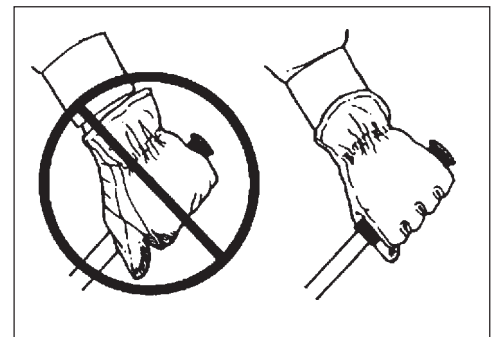

DESCRIPTION

The ECHO product you purchased has been factory pre-assembled for your convenience. Due to packaging restrictions, shield installation and other assembly may be necessary.

After opening the carton, check for damage. Immediately notify your retailer or ECHO Dealer of damaged or missing parts. Use the contents list to check for missing parts.

CONTENTS

<i>Contents List</i>		
Items	MODELS	
	SRM-2100SB	SRM-2400SB
1 - Power Head w/Upper Drive Shaft Assembly	√	√
1 - Lower Drive Shaft Assembly	√	√
1 - Plastic Bag (co-pack)	√	√
- 1, Operator's Manual	√	√
- 1, Safety Manual	√	√
- 1, Warranty Registration Card	√	√
- 1, Limited Warranty Statement	√	√
- 1, Plastic shield	√	√
- 1, Tool Bag	√	√
--1, 8 mm x 10 mm wrench	√	√
--1, screw	√	√
--1, locking tool	√	√
- 1, Nylon Trimmer Head	√	√
- 1, Safety Glasses	√	√
- 1, 2-Stroke Oil Sample, 2.6 oz.	√	√
- 1, Front Handle (L.H.) Assembly	√	√
-- 1, Plastic Bag	√	√
---1, shield plate	√	√
--- 3, 5 mm x 15 mm screws (shield mounting)	√	√

BLADE TERMS & DEFINITIONS

Blade Convertible

Models (SRM-2100SB, SRM-2400SB) can be converted to utilize blades. Plastic/nylon blades require a, "Blade Conversion Kit", which includes a shoulder harness, and steel shield with necessary attaching hardware. Steel/metal blades also require the, "Blade Conversion Kit", plus a "U-Handle Kit" or a Combo Kit.

EMISSION CONTROL

Type 1E Models

The emission control system for this engine is EM (Engine Modification).

Emission Control Label located on Engine (EXAMPLE ONLY, information on label varies by FAMILY).

IMPORTANT ENGINE INFORMATION
 ENGINE FAMILY: YEHXS.0254CB
 DISPLACEMENT: 25.4 cc
 THIS ENGINE MEETS U.S. EPA PH1 EMISSION REGULATIONS FOR SMALL NON ROAD ENGINES.
 REFER TO OWNER'S MANUAL FOR MAINTENANCE SPECIFICATIONS AND ADJUSTMENTS.

E **KOHATZ CORP.** **###**

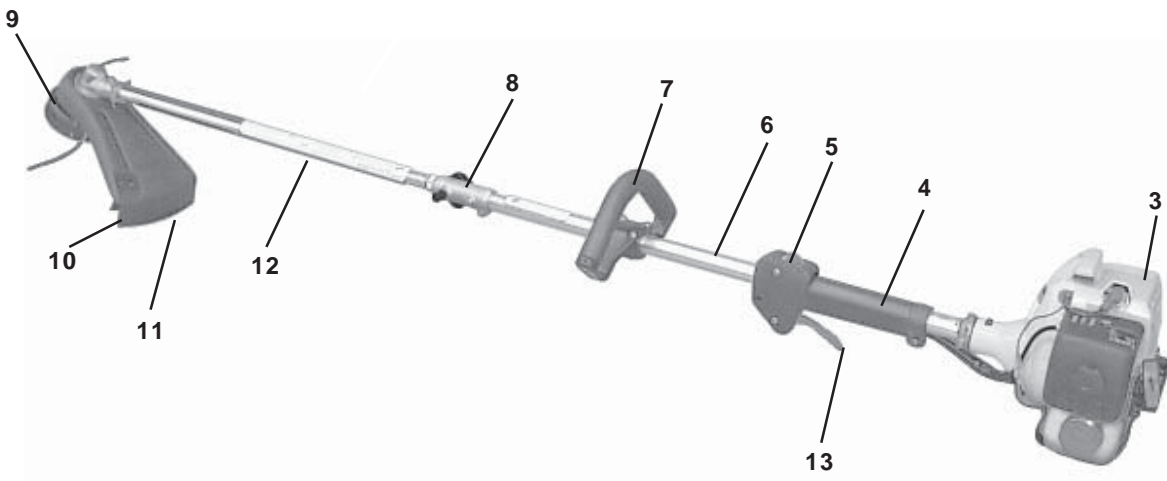
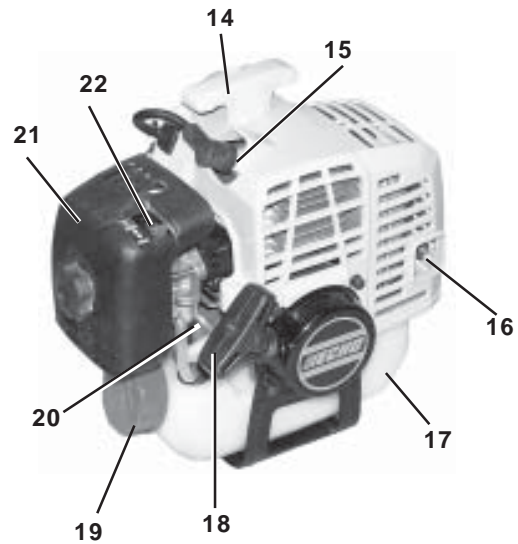
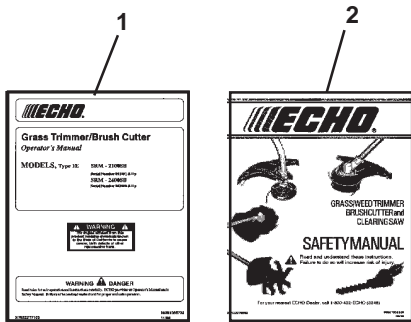

1. **OPERATOR'S MANUAL** - Included in plastic bag (co-pack). Read before operation and keep in a safe place for future reference, i.e., operation, maintenance, storage and specifications.
2. **SAFETY MANUAL** - Included in plastic bag (co-pack). Read before operation to learn proper, safe operating techniques. Keep in a safe place for future reference.
3. **POWER HEAD** - Includes the Engine, Clutch, Fuel System, Ignition System and Recoil Starter.
4. **GRIP** - Rear (right hand) handle.
5. **STOP SWITCH** - "SLIDE SWITCH" mounted on top of the Throttle Trigger Housing. Move switch FORWARD to RUN, BACK to STOP.
6. **UPPER DRIVE SHAFT ASSEMBLY** - Includes the Rear (Right Hand) Grip Assembly, Front (Left Hand) Handle Assembly, Upper Flexible Drive Cable, Drive Shaft Assembly Coupler and Power Head.
7. **FRONT HANDLE** - The front (loop) handle must be assembled to the Upper Drive Shaft Assembly (some models) and must be positioned for proper cutting attitude and operator comfort.
8. **DRIVE SHAFT COUPLER** - Includes Locator Pin and Clamping Knob.
9. **NYLON CUTTING ATTACHMENT** - Contains replaceable nylon trimming line that advances when the trimmer head is tapped against the ground while the head is turning at normal operating speed.
10. **CUT-OFF KNIFE** - Automatically trims line to the correct length: 5" after head is tapped on the ground. If trimmer is operated without a cut-off knife the line will become too long, the engine will overheat and engine damage may occur.
11. **PLASTIC DEBRIS SHIELD ASSEMBLY** - Included in plastic bag (co-pack). **MUST** be installed on unit before use, see Assembly Instructions. Shield assembly includes the Cut-Off Knife and Safety Decal. Mounts on the Gear Housing Assembly just above the cutting attachment. Helps protect the operator by deflecting debris produced during the trimming operation. This shield must be replaced with the steel shield for blade use.
12. **LOWER DRIVE SHAFT ASSEMBLY** - Includes the Debris Shield Assembly, Gear Housing Assembly, Lower Flexible Drive Cable, Nylon Cutting Attachment and Safety Decal.
13. **THROTTLE TRIGGER** - Spring loaded to return to idle when released. During acceleration, press trigger gradually for best operating technique.
14. **ARM REST** - Provides arm rest during operation and protects arm from the hot engine.
15. **SPARK PLUG** - Provides spark to ignite fuel mixture.
16. **MUFFLER/SPARK ARRESTOR** - The muffler controls the exhaust noise while the spark arrestor prevents hot, glowing particles of carbon from leaving the muffler where they could possibly start a fire.
17. **FUEL TANK** - Contains fuel and fuel filter.
18. **RECOIL STARTER HANDLE** - Pull recoil starter handle slowly until starter engages, then quickly and firmly. When engine starts, return handle slowly. **DO NOT** let handle snap back or damage to unit will occur.
19. **FUEL TANK CAP** - Covers and seals fuel tank opening.
20. **PRIMER BULB** - Pumping primer bulb before starting engine draws fresh fuel from the fuel tank priming the carburetor for starting. Pump the bulb 10 times until fuel is visible in clear fuel return line.
21. **AIR CLEANER** - Contains replaceable filter element.
22. **CHOKE** - The choke control lever is located on the top of the air filter case. Move lever to "COLD START" to close choke for cold starting. Move lever to the "RUN" position to open choke.
23. **SAFETY VIDEO** - (Not included with unit) P/N 99922202540 English version only is available at a cost of \$5.00 from ECHO, INC. or any authorized ECHO dealer. The video overviews safety precautions and proper operating techniques and is supplemental to the Safety Manual. Read and understand the Safety Manual for complete information on safe operation.

SPECIFICATIONS

MODEL	SRM-2100SB	SRM-2400SB
Shaft Length	1500 mm (59 in.)	
Unit Width	330 mm (13.0 in.)	
Unit Height	300 mm (11.8 in.)	360 mm (12.4 in.)
Weight (dry) w/cutting attachment	5.4 kg (11.9 lb.)	5.6 kg (12.4 lb.)
Engine Type	Air cooled, two-stroke, single cylinder gasoline engine	
Bore	32.2 mm (1.27 in.)	34.0 mm (1.34 in.)
Stroke	26.0 mm (1.04 in.)	
Displacement	21.2 cc (1.29 cu. in.)	23.6 cc (1.44 cu. in.)
Exhaust System	Spark Arrestor Muffler	
Carburetor	Zama Diaphragm model C1U w/purge	Walbro Diaphragm model WYJ w/purge
Ignition System	CDI (capacitor discharge ignition)	
Spark Plug	NGK BPM-7A Gap 0.65 mm (0.026 in.)	NGK BPM-7Y Gap 0.65 mm (0.026 in.)
Fuel	Mixed (Gasoline and Two-stroke Oil)	
Fuel/Oil Ratio	50:1 ECHO High Performance, two-stroke air cooled engine oil	
Gasoline	89 Octane unleaded. DO NOT use fuel containing methyl alcohol, more than 10% ethyl alcohol or 15% MTBE.	
Oil	50:1 ECHO High Performance, two-stroke air cooled engine oil	
Fuel Tank Capacity	0.4 lit. (14.0 US fl. oz.)	
Starter System	Automatic Recoil Starter	
Clutch	Centrifugal Type	
Drive Shaft (upper & lower)	1/4 in. Flex Shaft	
Rotating Direction	Counter clockwise viewed from top	
Cutting Attachment	Nylon line head (2-line) with .095 in. Cross Fire™ line capacity 13 m (40 ft.)	
Handles*	Front - Loop, Rear - Grip, when operating with standard line head	
Shoulder Harness	Optional	
Idle Speed (RPM)	2700 - 3300	
Wide Open Throttle Speed (**RPM)	8300 - 9500	

* Install and use U-Handle when operating any model with blade.

**The RPM range shown applies for all attachments. Refer to your attachment Operator's Manual "Specifications" section for proper RPM specifications.

ASSEMBLY

ECHO APPROVED OPTIONAL ATTACHMENTS

WARNING  **DANGER**

Use only ECHO approved attachments for these models. Serious injury may result from the use of non approved attachment combinations. Read and comply with all safety instructions listed in this manual and attachment manual.

ECHO, INC. will not be responsible for the failure of cutting devices, attachments or accessories which have not been tested and approved by ECHO for use with these units.

Model	SRM-2100SB	SRM-2400SB
SRM Edger Attachment #99944200470	√	√
SRM Cultivator Attachment #99944200510	√	√
SRM Trimmer Attachment #99944200540	√	√
SRM Hedge Clipper Attachment #99944200480	√	√
SRM Power Pruner™ Attachment #99944200530	√	√
ProSweep™ Attachment #99944200550		√
ProThatch™ Attachment #99944200560		√

POWER HEAD SHAFT/LOWER SHAFT ASSEMBLY

Tools Required: None

Parts Required: Power Head Shaft, Lower Shaft Assembly

1. Set Power Head/Shaft Assembly on a level surface.
2. Loosen clamping knob (A).
3. Pull locator pin (B) and rotate counter clockwise 1/4 turn to lock out position.
4. Carefully fit lower drive shaft assembly into coupler (C) to decal assembly line (D), making sure that the inner lower drive shaft engages into the upper drive shaft mount.

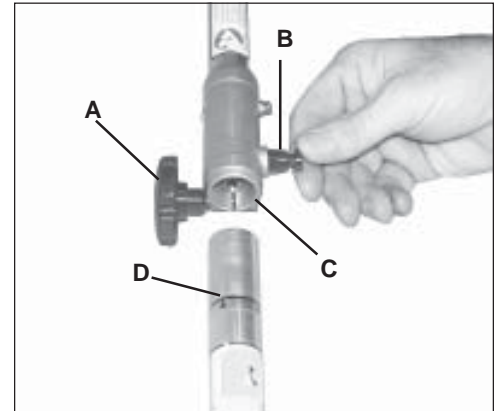

NOTE

Lower bearing housing and head assembly must be in line with the engine.

5. Rotate locator pin (B) 1/4 turn clockwise to engage lower drive shaft hole. Insure locator pin is fully engaged by gently twisting lower drive shaft. Locator pin should snap flush in coupler. Full engagement will prevent further shaft rotation.
6. Secure lower shaft assembly to coupler by tightening clamping knob (A).

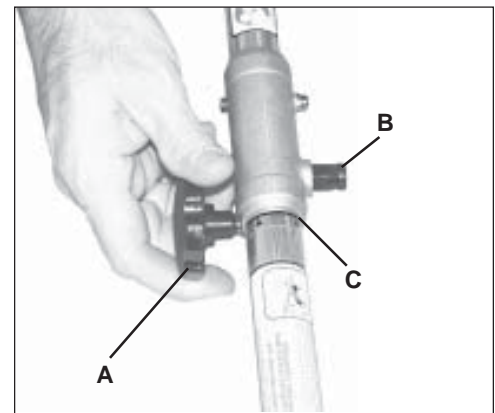

PLASTIC SHIELD INSTALLATION

(For Nylon Line Operation)

Tools Required: Screwdriver.

Parts Required: Plastic Shield, Shield Plate, three (3) 5 mm x 15 mm screws.

NOTE

The plastic shield is for use with the Nylon Line Head only. Install Metal Shield when using plastic or metal blades.

1. Snap the shield on the bottom of the bearing housing flange.
2. Place shield plate on shield, align holes and install three (3) screws.



NYLON LINE HEAD INSTALLATION

Tools Required: Head Locking Tool

Parts Required: Nylon Line Head.

1. Align locking hole in upper plate (B) with notch in edge of gear housing and insert head locking tool (A).
2. Remove plastic sleeve from P.T.O. shaft (C).
3. Be sure upper plate (B) remains on P.T.O. shaft.
4. Thread line head onto P.T.O. shaft by turning it counter clockwise until head is tight against upper plate (B).
5. Remove locking tool (B).

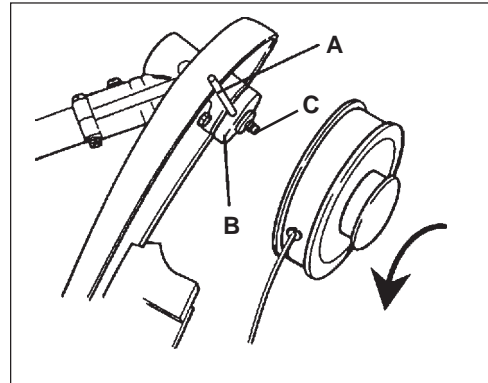

FRONT HANDLE INSTALLATION

Tools Required: Screwdriver.

Parts Required: Front Handle Assembly

1. Assemble front handle on drive shaft, DO NOT tighten screws yet.
2. Position front handle for comfortable operation and secure screws.



PRE - OPERATION

OPERATION WITH BLADES

Preparing the Trimmer/Brush Cutter for Blade Use

WARNING DANGER

Blade use **DEMANDS** specific Brush Cutter configuration. Operation without specified shield and harness can result in serious personal injury. Follow installation instructions included in optional kits.

Plastic and Nylon Blades Require "Blade Conversion Kit," P/N 99922200410 (metal shield [A] and shoulder harness [B]).



Steel/Metal Blades Require:

SRM-2100SB "Combination Blade" and "U-Handle Kit" P/N 99944200451.

SRM-2400SB "Combination Blade" and "U-Handle Kit" P/N 99944200521.



Choosing the Correct Blade

WARNING DANGER

The type of Blade used **MUST** be matched to the type and size of material cut. An improper or dull blade can cause serious personal injury. Blades **MUST** be sharp. Dull blades increase the chance of kick out and injury to yourself and bystanders.

Plastic/Nylon Blades may be used where ever the nylon line head is used. **DO NOT** use this blade for heavy weeds or brush!



8 Tooth Weed/Grass Blade P/N 69600120331 is designed for grass, garden debris and thick weeds. **DO NOT** use this blade for brush or heavy woody growth, 3/4" (19 mm) diameter or larger.

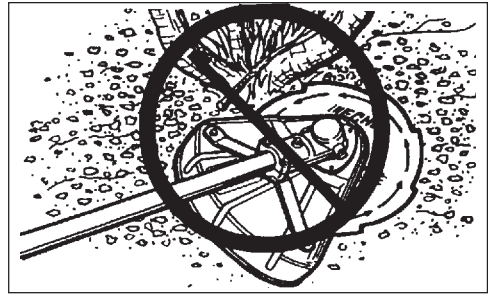

Brush/Clearing Blade P/N 69500120331 is designed for cutting brush and woody growth up to 3" (76 mm) diameter.



Use Shoulder/Waist Harness P/N 99944200200 The Shoulder/Waist Harness when used in a trimming operation with nylon line head suspends the trimmer from the operator's shoulder and reduces operator fatigue.



During blade operation, the same fatigue reduction is achieved. Safety to the operator is also enhanced by preventing blade contact with the operator's hands and feet by restricting trimmer movement.

NOTE

In case of Emergency, pull up on the Quick Release Collar to disconnect the trimmer from the harness.

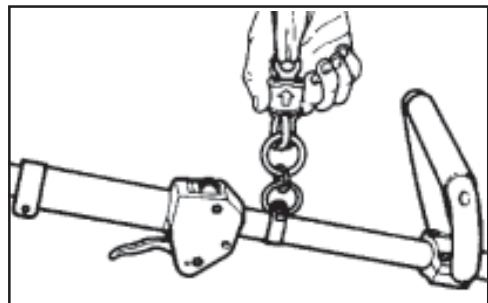

FUEL

Fuel Requirements --

Gasoline - Use 89 Octane [$\frac{R+M}{2}$] gasoline known to be good quality. Gasoline may contain up to 10% Ethanol (grain alcohol) or 15% MTBE (methyl tertiary-butyl ether). Gasoline containing methanol (wood alcohol) is NOT approved.

Two Stroke Oil - A two-stroke engine oil meeting ISO-L-EGD Standard (ISO/CD 13738), must be used. Echo brand Premium 50:1 oil meets this standard. Engine problems due to inadequate lubrication caused by failure to use an ISO-L-EGD approved oil, such as Echo Premium 50:1 Two-stroke Oil, will void the two-stroke engine warranty. (Emission related parts only are covered for two years, regardless of two-stroke oil used, per the statement listed in the EPA Phase I/California Emission Defect Warranty Explanation.)

Mixing - Follow directions on the oil container.

Handling Fuel --

WARNING DANGER

Fuel is **VERY** flammable. Use extreme care when mixing, storing or handling or serious personal injury may result.

- Use an approved fuel container.
- DO NOT smoke near fuel.
- DO NOT allow flames or sparks near fuel.
- Fuel tanks/cans may be under pressure. Always loosen fuel caps slowly allowing pressure to equalize.
- NEVER refuel a unit when the engine is HOT!
- NEVER refuel a unit with the engine running.
- DO NOT fill fuel tanks indoors. ALWAYS fill fuel tanks out doors over bare ground.
- Securely tighten fuel cap after refueling.
- Inspect for fuel leakage. If fuel leakage is found, do not start or operate unit until leakage is repaired.

After Refueling –

- Wipe any spilled fuel from the unit.
- Move at least 3M (10 ft.) from refueling location before starting.

After Use –

- DO NOT store a unit with fuel in its tank. Leaks can occur. Return unused fuel to an approved fuel storage container.

Storage –

Fuel storage laws vary by locality. Contact your local government for the laws affecting your area. As a precaution, store fuel in an approved, air tight container. Store in a well ventilated, unoccupied building, away from sparks and flames. Do not store fuel longer than 30 days.

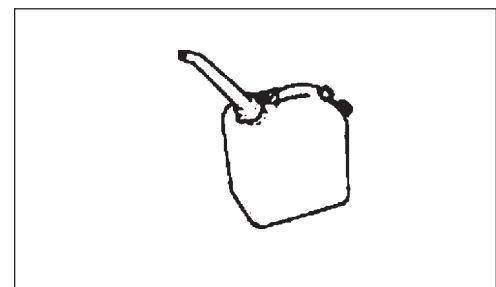
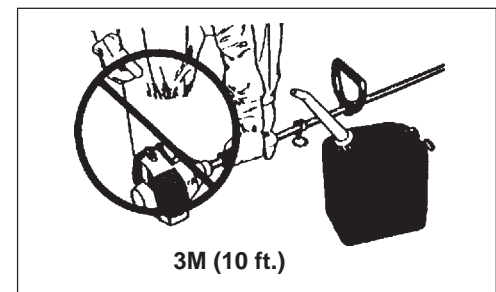
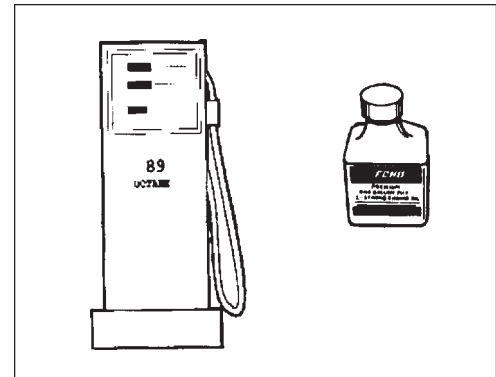

IMPORTANT

Stored fuel ages. Do not mix more fuel than you expect to use in thirty (30) days, ninety (90) days when a fuel stabilizer is added.

IMPORTANT

Stored two-stroke fuel may separate. ALWAYS shake fuel container thoroughly before each use.

S	M	T	W	T	F	S
1	2	3	4	5	6	7
8	9	10	11	12	13	14
15	16	17	18	19	20	21
22	23	24	25	26	27	28
29	30	31				

EQUIPMENT CHECK

Before operation a complete check of the unit must be performed;

- Check unit for loose/missing nuts, bolts and screws. Tighten and/or replace as needed.
- Inspect fuel lines, tank and area around carburetor for fuel leaks. DO NOT operate unit if leaks are found.
- Inspect shield for damage and ensure that the cut-off knife is securely in place. Replace if either is damaged or missing.
- Check that the cutting attachment is firmly attached and in safe operating condition.
- Check that front handle and shoulder strap or shoulder/waist harness are adjusted for safe, comfortable operation. See Assembly section for proper adjustment.



DETERMINE OPERATION AREA

- Review the area to be trimmed. Look for hazards that could contribute to unsafe conditions.
- Spectators and fellow workers must be warned, and children and animals prevented from coming nearer than 15M (50 ft.) while the trimmer is in use.

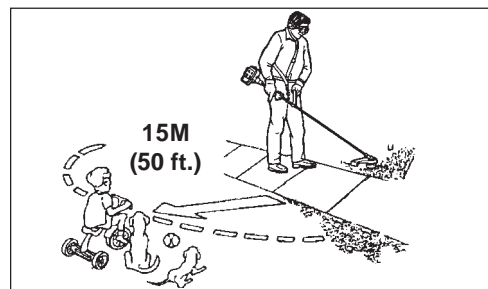

OPERATION

- Provide all operators of this equipment with the operator's manual and instructions for safe operation.
- Before starting the unit, equip yourself and any other person working within the 15M (50 ft.) Safety Zone with the required Protective Equipment and clothing.
- During operation, the complete unit, especially the drive shaft housing and the bearing housing may become very hot, too hot to touch. Avoid contact during and immediately after operation.

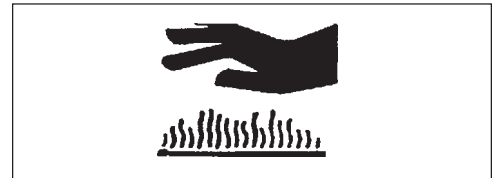
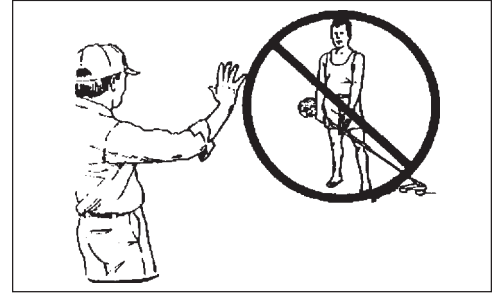

STARTING COLD ENGINE

WARNING DANGER

The cutting attachment should not rotate at idle. If attachment rotates, readjust carburetor according to "Carburetor Adjustment" instructions in this manual or see your ECHO Dealer, otherwise serious personal injury may result.

All Models

1. Stop Switch - Start/Run.
Move stop switch button (A) forward away from the STOP position.
2. Choke Lever - Cold Start.
Move choke (B) to "Cold Start" Position.
3. Primer Bulb - Prime.
Pump primer bulb (C) 10 times. Fuel will be visible and flow freely in the clear fuel tank return line.

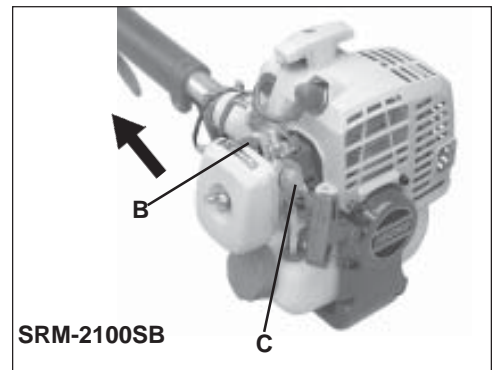
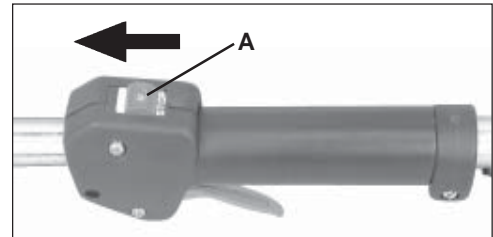

WARNING DANGER

Inspect starting area for hazards such as rocks, glass, debris etc. which could be contacted by the cutting attachment when starting. Keep helpers and bystanders at least 15 M (50 ft.) from starting area, otherwise serious personal injury may result.

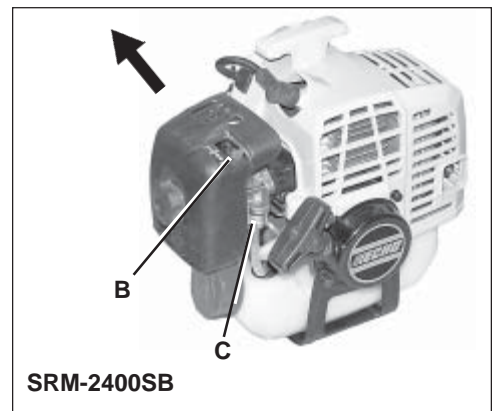

SRM-2100SB

4A. Start

Lay the trimmer on a flat clear area. Firmly grasp rear handle grip and throttle lockout with left hand and fully depress throttle trigger to wide open position. Rapidly pull recoil starter handle/rope (D) until engine fires (or maximum five [5] pulls).

5A. After engine fires (or five [5] pulls), move choke to "Run" position. Hold throttle trigger fully depressed and pull recoil starter handle/rope (D) until engine starts and runs. Release throttle trigger and allow unit to warm up at idle for several minutes.

SRM-2400SB

4B. Start - Pull Rope.

Lay the trimmer on a flat clear area and pull the recoil starter handle (D) until engine fires.

5B. Open Choke - Run.

Move the choke to the OPEN - RUN position. Restart engine if necessary and allow to warm up running at idle for several minutes.

All Models

NOTE

If engine does not start with choke in "Run" position after 5 pulls, repeat instructions 4 (A/B) and 5 (A/B).

6. After engine warm up, gradually depress throttle trigger to increase engine RPM to operating speed.

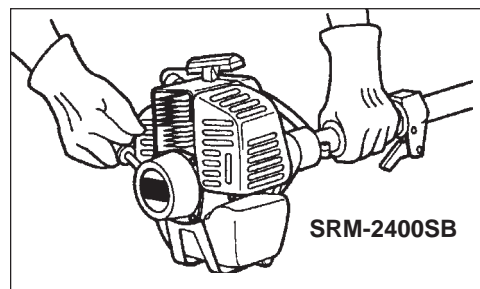
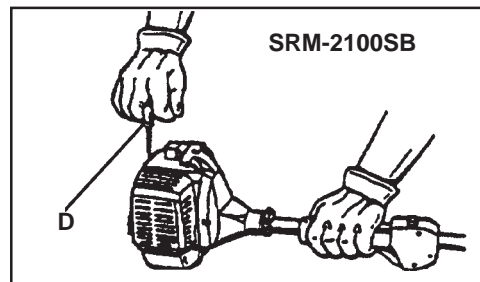

STARTING WARM ENGINE

All Models

The starting procedures is the same as Cold Start except DO NOT close the choke.

WARNING DANGER

The cutting attachment should not rotate at idle. If cutting attachment moves, readjust carburetor according to "Carburetor Adjustment" instructions in this manual or see your ECHO Dealer, otherwise serious personal injury may result.

1. Stop Switch - Start/Run. Move stop switch button (A) forward away from the STOP position.
2. Primer - Pump Bulb. Pump primer bulb (C) until fuel is visible in the "Clear" fuel return line.

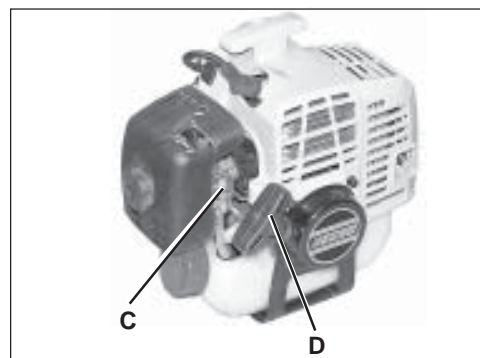
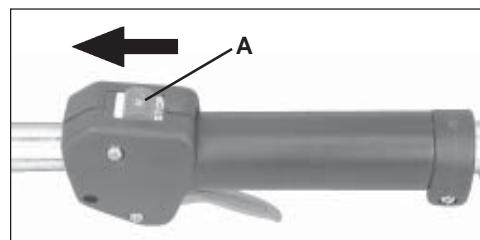

3. Start - Pull Rope. Lay the trimmer on a flat clear area and pull the recoil starter handle (D) until the engine fires.

NOTE

If engine does not start after 5 pulls, use Cold Start Procedure.

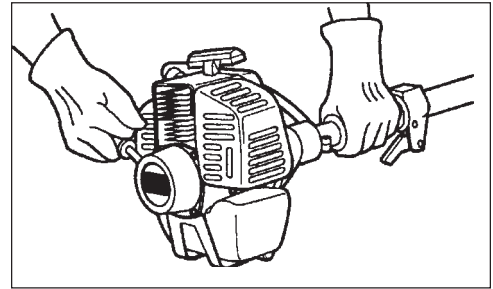

STOPPING ENGINE

1. Release Throttle. Allow engine to idle for a minute.
2. Stop Switch - Stop. Move stop switch button (A) backward to STOP position.

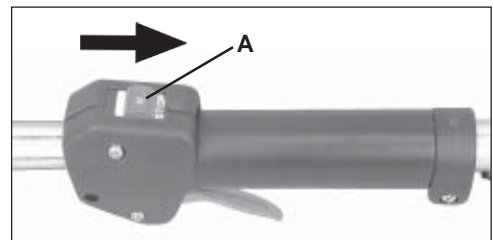

WARNING  **DANGER**

If engine does not stop when stop switch is moved to STOP position, close choke - COLD START position - to stall engine. Have your ECHO dealer repair stop switch before using trimmer again.

MAINTENANCE

Your ECHO trimmer is designed to provide many hours of trouble free service. Regular scheduled maintenance will help your trimmer achieve that goal. If you are unsure or are not equipped with the necessary tools, you may want to take your unit to an ECHO Service Dealer for maintenance. To help you decide whether you want to DO-IT-YOURSELF or have the ECHO Dealer do it, each maintenance task has been graded. If task is not listed, see your ECHO dealer for repairs.

SKILL LEVELS

- Level 1** = Easy to do. Most required tools come with unit.
- Level 2** = Moderate difficulty. Some specialized tools may be required.
- Level 3** = Experience required. Specialized tools are required.

ECHO offers **REPOWER™** Maintenance Kits and Parts to make your maintenance job easier. Below each task heading are listed the various part numbers required for that task. See your ECHO dealer for these parts.

MAINTENANCE INTERVALS

COMPONENT/ SYSTEM	MAINTENANCE PROCEDURE	REQ'D SKILL LEVEL	DAILY OR BEFORE USE	EVERY REFUEL	3 MONTHS OR 90 HOURS	6 MONTHS OR 270 HOURS	YEARLY 600 HOURS
Recommended Echo Dealer Maintenance Procedures							
Cylinder Exhaust Port	Inspect/Clean/Decarbon	3			I / C		
Do-It-Yourself Maintenance Procedures							
Air Filter	Inspect/Clean/Replace	1	I / C		R*		
Choke	Inspect/Clean	2	I / C				
Fuel Filter	Inspect/Replace	1			I		I / R *
Fuel System, leaks	Inspect/Replace	1	I *	I	I		
Cooling System	Inspect/Clean	2	I / C				
Muffler Spark Arrestor	Inspect/Replace	2			I / R *		
Drive Shaft (Flex Cable Models)	Grease	2			I (1)		
Gear Housing	Grease	2			I (2)		
Recoil Starter Rope	Inspect/Clean	1	I / C *				
Spark Plug	Inspect/Clean	2			I / C	R *	
Screws/Nuts/Bolts	Inspect/Tighten/Replace	1	I / R *				
<p>MAINTENANCE PROCEDURE LETTER CODES: I = INSPECT, R = REPLACE, C = CLEAN</p> <p>IMPORTANT NOTE - Time intervals shown are maximum. Actual use and your experience will determine the frequency of required maintenance.</p> <p>MAINTENANCE PROCEDURE NOTES:</p> <p>(1) Apply ECHO® LUBE™ every 25 hours of use.</p> <p>(2) Apply ECHO® LUBE™ every 50 hours of use.</p> <p>* All recommendations to replace are based on the finding of damage or wear during inspection..</p>							

AIR FILTER

Level 1.

Tools required: Cleaning brush, 1" or 2" medium bristle paint brush.

Parts required:

SRM-2100SB 90008 REPOWER™ AIR & FUEL FILTER KIT.
SRM-2400SB 90030 REPOWER™ AIR & FUEL FILTER KIT.

1. Close choke (Cold Start Position). This prevents dirt from entering the carburetor throat when the air filter is removed. Brush accumulated dirt from the air cleaner area.
2. Remove the air cleaner cover. Clean and inspect the element for damage. If element is fuel soaked and very dirty, replace.
 - still fits the cavity in the air cleaner cover.
 - is installed with the original side out.

NOTE

Carburetor adjustment may be needed after air filter cleaning/
replacement.

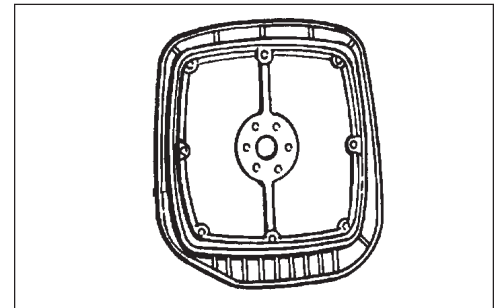
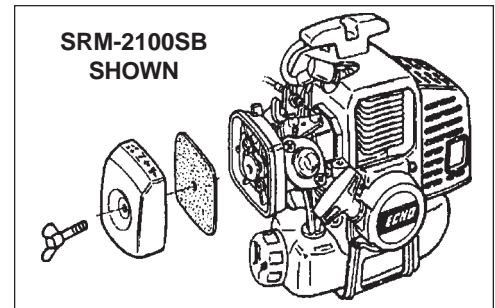
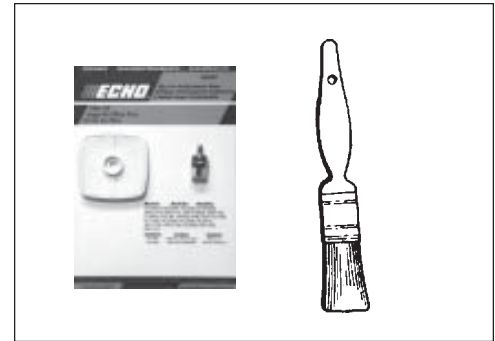

FUEL FILTER

Level 1.

Tools required: 203-254 mm (8 - 10 in.) length of wire with one end bent into a hook, Clean rag, funnel, and an approved fuel container.

Parts required:

SRM-2100SB 90008 REPOWER™ AIR & FUEL FILTER KIT.
SRM-2400SB 90030 REPOWER™ AIR & FUEL FILTER KIT.

WARNING DANGER

Fuel is **VERY** flammable. Use extreme care when mixing, storing or handling, otherwise serious personal injury may result.

1. Use a clean rag to remove loose dirt from around fuel cap and empty fuel tank.
2. Use the "fuel line hook" to pull the fuel line and filter from the tank.
3. Remove the filter from the line and install the new filter.

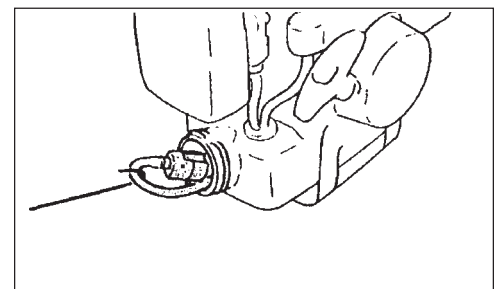
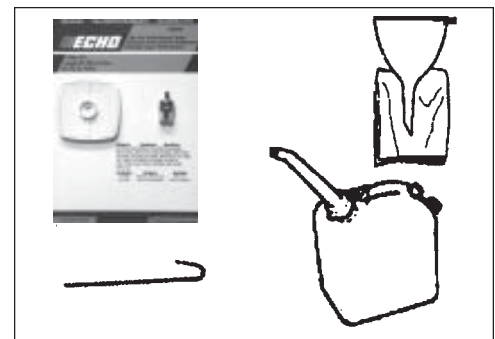

SPARK PLUG

Level 2.

Tools required: Srench (combination socket wrench and screwdriver), Feeler gauge (preferably a wire gauge), Brush.

Parts Required: Spark Plug, SRM-2100SBNGKBPM-7A
SRM-2400SBNGKBPM-7Y

1. Remove spark plug and check for fouling, worn and rounded center electrode.
2. Clean the plug or replace with a new one. DO NOT sand blast to clean. Remaining sand will damage engine.
3. Adjust spark plug gap by bending outer electrode.
4. Tighten spark plug to 145-155 kg/cm (125-135 in. lb.).

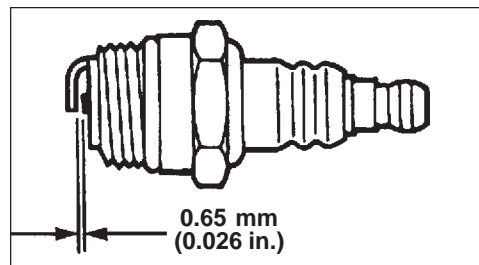
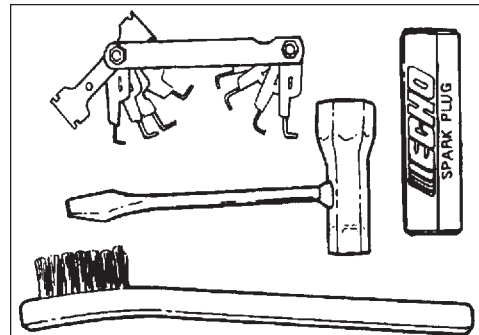

COOLING SYSTEMS CLEANING

Level 3.

Tools required: Cross Head Screwdriver, 3 mm Hex Wrench, Pointed Wood Stick, Cleaning brush (1" - 2" medium bristle paint brush).

Parts Required: None if you are careful.

IMPORTANT

To maintain proper engine operating temperatures, cooling air must pass freely through the cylinder fin area. This flow of air carries combustion heat away from the engine.

Overheating and engine seizure can occur when:

- Air intakes are blocked, preventing cooling air from reaching the cylinder.
- Dust and grass build up on the outside of the cylinder. This build up insulates the engine and prevents the heat from leaving.

Removal of cooling passage blockages or cleaning of cooling fins is considered "Normal Maintenance". Any failure attributed to lack of maintenance is not warranted.

1. Remove spark plug lead and throttle linkage end from the carburetor swivel.
2. Remove the three screws that retain the engine cover (A). Two at the top of the recoil starter, one in the arm rest. Lift the cover from the engine.

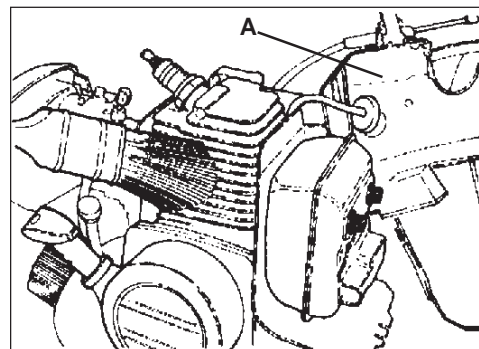
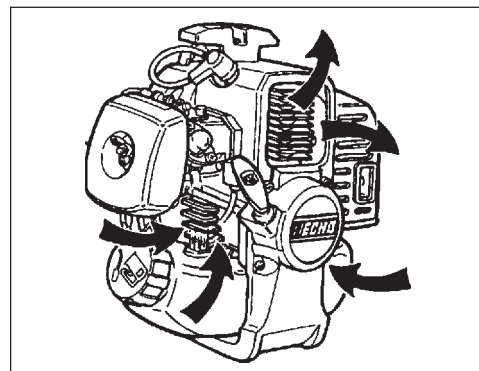
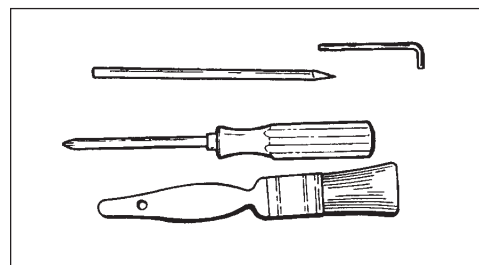

- Use the wooden stick or brush to remove dirt form cylinder fins.

IMPORTANT

Do not use a metal scraper to remove dirt from the cylinder fins.

- Remove grass and leaves from the grid between the recoil starter and fuel tank.

- Assemble components in reverse order.

NOTE

When installing the engine cover, be certain the tab of the metal deflector shield is in the slot of the engine cover.

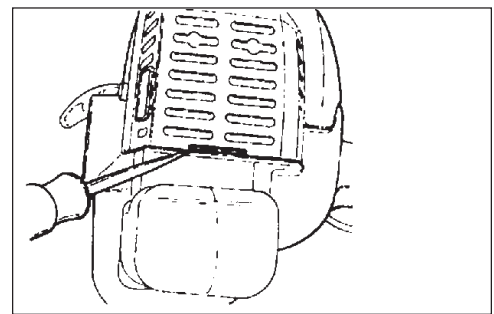
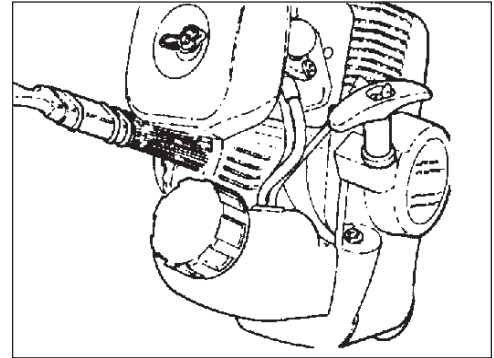

EXHAUST SYSTEM

Spark Arrestor Screen

Level 2.

Tools required: Cross Head Screwdriver, 3 mm Hex Wrench, Soft Metal Brush, Wooden Carbon Scraper.

Parts Required: Screen P/N 14586240630, Gasket Lid P/N 14586642031

- Remove engine cover (A). See “Cleaning Cooling System” pages 26 & 27 for step by step instructions.
- Place piston at Top Dead Center (TDC) to prevent carbon/dirt from entering cylinder.
- Remove spark arrestor screen cover (B), screen holder (C), gasket (D) and screen (E) from muffler body.
- Clean carbon deposits from screen and muffler components.
- Replace screen if it is cracked, plugged or has holes burned through.
- Assemble components in reverse order

NOTE

When installing the engine cover, be certain the tab of the metal deflector shield is in the slot of the engine cover.

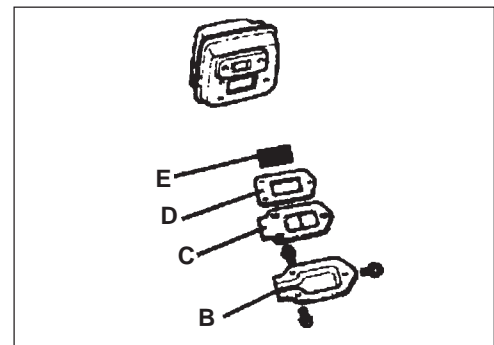
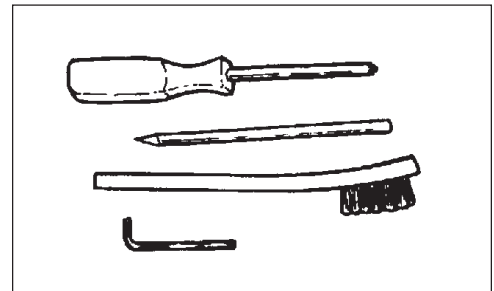

CARBURETOR ADJUSTMENT

SRM-2100SB Emission Models

Level 2.

Tools required: Screwdriver, Tachometer (ECHO P/N 99051130017)

Parts required: None.

NOTE

Every unit is run at the factory and the carburetor is set in compliance with EPA Phase 1 and California Emission Regulations. In addition, the carburetor is equipped with HI and LO needle adjustment limiters that prevent settings outside acceptable limits.

1. Before adjusting the carburetor, clean or replace the air filter and spark arrester screen.
2. Trimmer line must be extended to the cut-off knife.
3. Start engine and run for several minutes to reach operating temperature.
4. Stop engine. Turn HI speed needle (C) CCW (counter clockwise) to stop. Turn LO speed needle (B) midway between full CCW and CW (clockwise) stops.
5. Idle Speed Adjustment.
 - Start engine and turn "idle" speed adjustment screw (A) CW until the cutting attachment begins to turn, then turn the screw CCW until cutting attachment stops turning. Turn screw CCW an additional 1/4 turn.
6. Accelerate to full throttle for 2-3 seconds to clear excess fuel from engine then return to idle. Accelerate to full throttle to check for smooth transition from idle to full throttle. If engine hesitates, turn LO needle (B) CCW an additional 1/8 turn and repeat acceleration. Continue adjusting until smooth acceleration results.
7. Check HI speed RPM at W.O.T. (Wide Open Throttle). HI speed RPM should be set to specifications found on page 13 "Specifications" of this manual.
8. Check idle speed and reset if necessary. If a tachometer is available, idle speed should be set to the specification found on page 13 "Specifications" of this manual.

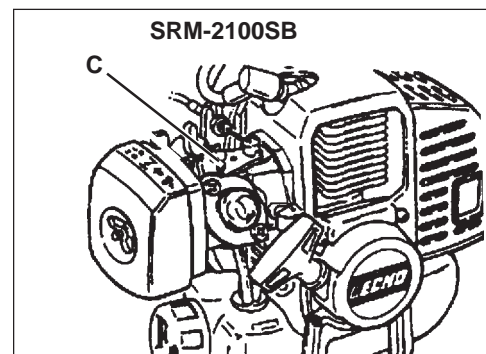
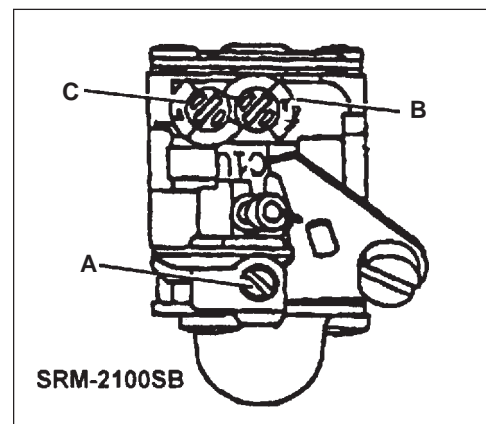
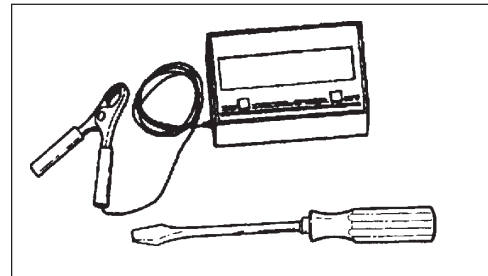

WARNING DANGER

When carburetor adjustment is completed, the cutting attachment should not turn at idle, otherwise serious personal injury may result.

CARBURETOR ADJUSTMENT

SRM-2400SB Emission Models

Level 2.

Tools required: Screwdriver, Tachometer (ECHO P/N 99051130017).

Parts required: None.

NOTE

Every unit is run at the factory and the carburetor is set in compliance with EPA Phase 1 and California Emission Regulations. This carburetor does not have acceleration and high speed adjustment needles. Do not attempt to use carburetor adjustment procedures provided in the Warranty/Emissions Booklet.

1. Check idle speed and reset if necessary. If a tachometer is available, idle speed screw (A) should be set to the specifications found on page 13 "Specifications" of this manual. Turn idle screw (A) clockwise to increase idle speed; counter clockwise to decrease idle speed.

WARNING DANGER

When carburetor adjustment is completed, the cutting attachment should not turn at idle, otherwise serious personal injury may result.

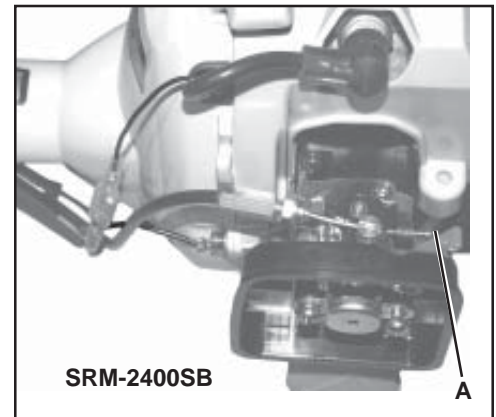
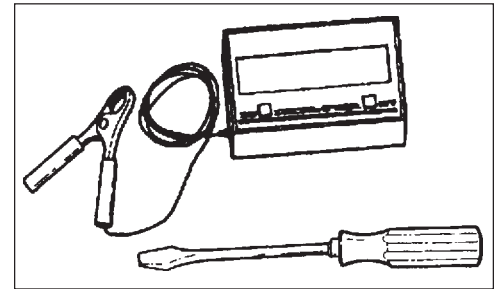

LUBRICATION

Level 1.

Tools Required: 8 mm Open End Wrench, Screwdriver, Clean Rag

Parts Required: Lithium Base Grease.

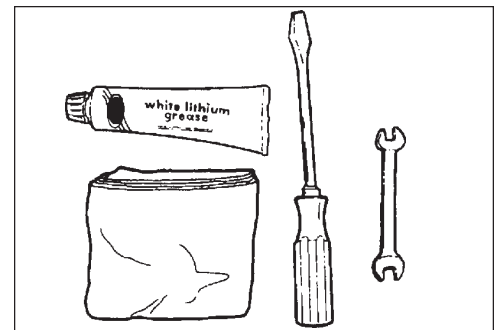

Gear Housing

1. Clean all loose debris from gear box.
2. Remove plug (A) and check level of grease.
3. Add grease if necessary, DO NOT over fill.

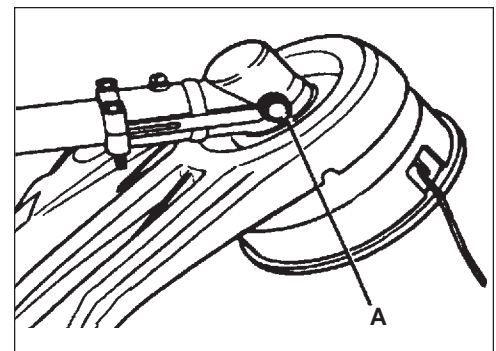

Drive Shaft (Lower)

IMPORTANT

Lower and upper drive shaft must be lubricated with high temperature automotive grease every 25 hours of operation, otherwise drive shaft assembly overheating and failure can result.

1. Loosen two clamping bolts (A) and remove locator screw (B).
2. Remove gear case assembly from lower drive shaft housing.
3. Remove lower flex drive cable, wipe clean and apply a thin coating of 1/2 oz. [15 ml] of high temperature automotive grease.
4. Install flex drive cable making sure inner lower flex cable engages into the upper drive shaft mount.

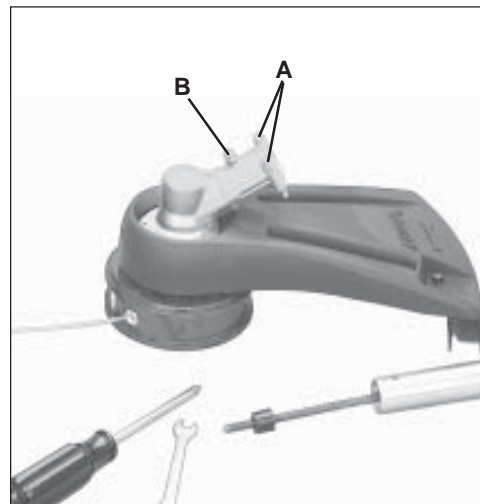

Drive Shaft (Upper)

1. Remove coupler from upper drive shaft assembly by loosening clamping screw (C) and removing set screw (D).
2. Remove upper flex drive cable, wipe clean and apply a thin coating of 15 ml (1/2 oz.) of high temperature automotive grease.
3. Install flex drive cable. Make sure that the flex cable engages into the clutch mount and also into the coupler mount.
4. Install set screw (D) and tighten clamping screw (C).
5. Align locator hole in gear case with hole in lower drive shaft housing and install gear case.

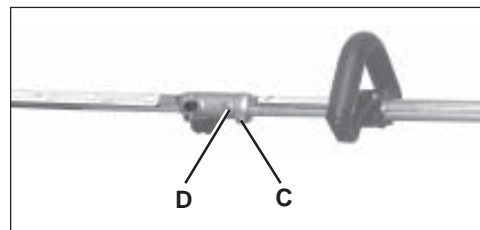

NOTE

Locator holes will not line up until lower flex drive cable is properly engaged in inner square socket of gear case.

6. Install locator screw (B) and tighten. Tighten clamping bolts (A).

NYLON LINE REPLACEMENT

Level 1.

Tools required: Head locking tool (if head is to be removed)

Parts Required: ECHO 0.095" Nylon Trimmer Line 12 m (40 ft.) long.

1. Hold drum (A) and turn spool (B) CW (clockwise) until it stops. Pull spool from drum. DO NOT push in on spool when turning.

2. Use one piece of new nylon line (C) 12 m (40 ft.) long and thread through the molded loop (D) on the spool. Pull line tight and adjust so one end is 15 cm (6 in.) longer than the other.

3. Hold the spool, opening toward you. Place index finger between the two strands and wind line, tightly and evenly, in direction of arrow marked "CC".

4. Stop when approximately 15-20 cm (6" - 8") line (C) remains and place ends of line in notches (E) in spool (B).

5. Feed ends of line through housing eyelets (F) and place spool (B) over drive (G). Align pegs (H) on drive with notches in spool and push spool into drum.

6. Pull on both lines until they come free from notches (E) in spool.

7. Hold drum (A) firmly and turn spool (B) CCW (counterclockwise) until it stops. DO NOT push in on spool when turning.

8. Pull both lines out and trim to cut-off knife length.

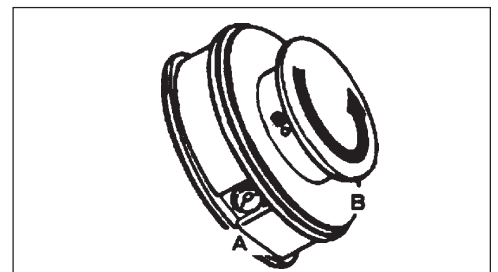
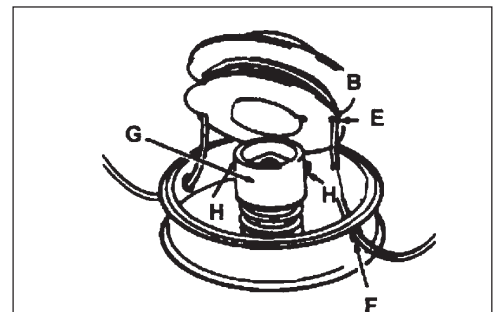
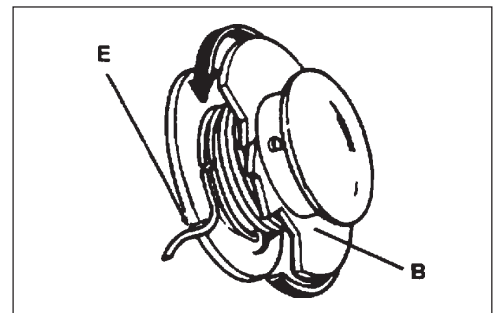
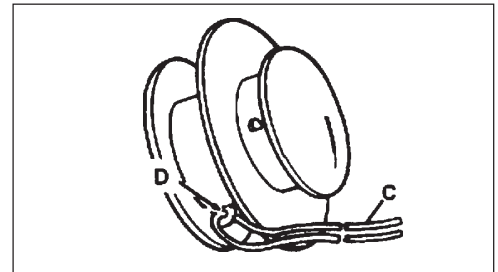
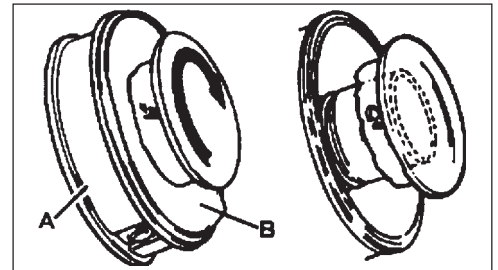
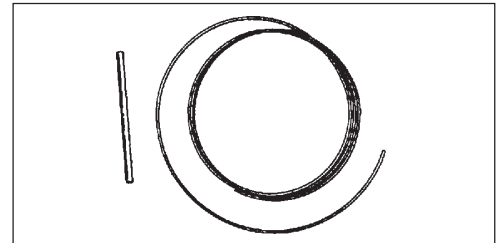

SHARPENING METAL BLADES

Three styles of metal blades are approved for use on the ECHO Brush Cutter. The 8-tooth blade can be sharpened during normal maintenance. The clearing blade and 80 tooth blade require professional service.

Before sharpening, CLOSELY inspect blade for cracks (look at the bottom of each tooth and the center mounting hole closely), missing teeth and bending. If ANY of these problems are discovered, replace the blade.

When sharpening a blade, always remove the same amount of materials from each tooth to maintain balance. A blade that is not balanced will cause unsafe handling due to vibration and can result in blade failure.

8-tooth Blade

Tool required: Flat file (preferred). Electric grinder if special care is used. Round (rat tail) file for gullet (radius).

1. File each tooth at a 30 degree angle a specific number of times, eg. 4 strokes per tooth. Work your way around the blade until all teeth are sharp.
2. DO NOT file the 'gullet' (radius) of the tooth with the flat file. The radius must remain. A sharp corner will lead to a crack and blade failure.

IMPORTANT

If an electric grinder is used, use care not to overheat teeth, do not allow tips/tooth to glow red or turn blue. DO NOT place blade in cooling water. This will change the temper of the blade and could result in blade failure.

3. After sharpening teeth, check each tooth radius for evidence of a square (sharp) corner. Use the round (rat tail) file to renew the radius.

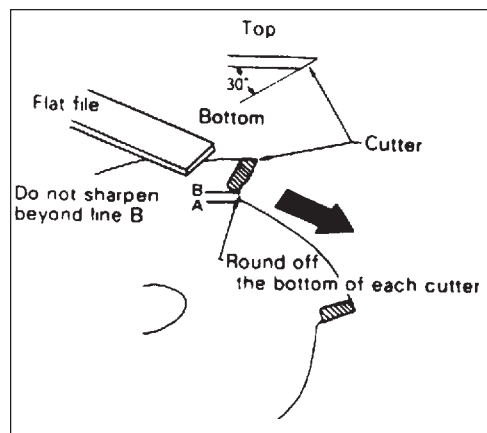
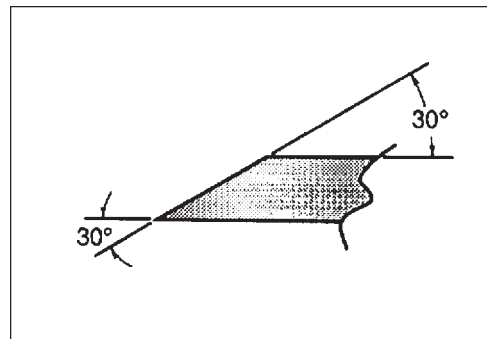
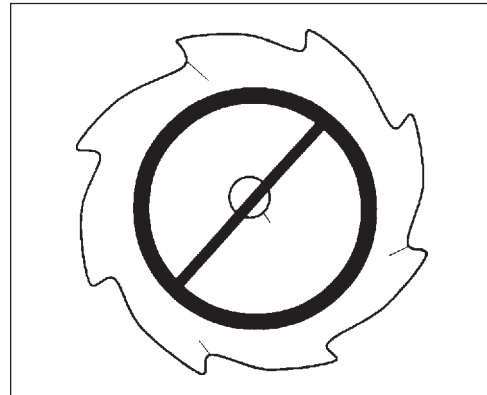

TROUBLESHOOTING

Problem				
Engine -- starts hard				
Engine -- does not start			Cause	Remedy
Engine Cranks	Fuel at carburetor	No fuel at carburetor	Fuel strainer clogged Fuel line clogged Carburetor	Clean Clean See your ECHO dealer
	Fuel at cylinder	No fuel at cylinder	Carburetor	See your ECHO dealer
		Muffler wet with fuel	Fuel Mixture is too rich	Open choke Clean/replace air filter Adjust carburetor See your ECHO dealer
	Spark at end of plug wire	No spark at end of plug wire	Stop switch off Electrical problem Interlock switch	Turn switch on See your ECHO dealer See your ECHO dealer
	Spark at plug	No spark at plug	Spark gap incorrect Covered with carbon Fouled with fuel Spark plug defective	Adjust 0.65mm (0.026in.) Clean or replace Clean or replace Replace plug
Engine does not crank			Internal engine problem	See your ECHO dealer
Engine runs	Dies or accelerates poorly		Air filter dirty Fuel filter dirty Fuel vent plugged Spark plug Carburetor Cooling system plugged Spark arrestor screen plugged	Clean or replace Replace Replace Clean and adjust/replace Adjust Clean Clean

WARNING  **DANGER**

Fuel vapors are **extremely** flammable and may cause fire and/or explosion. **Never** test for ignition spark by grounding spark plug against cylinder, otherwise serious personal injury may result.

STORAGE

Long Term Storage (over 30 days)

Do not store your unit for a prolonged period of time (30 days or longer) without performing protective storage maintenance which includes the following:

1. Store unit in a dry, dust free place, out of the reach of children.

WARNING DANGER

Do not store in enclosure where fuel fumes may accumulate or reach an open flame or spark.

2. Place the stop switch (A) in the "OFF" position.
3. Remove accumulation of grease, oil, dirt and debris from exterior of unit.
4. Perform all periodic lubrication and services that are required.
5. Tighten all the screws and nuts.
6. **Drain** the fuel tank **completely** and pull the recoil starter handle several times to remove fuel from the carburetor.
7. Remove the spark plug and pour 7 cc (1/4 oz.; 1/2 tablespoon) of fresh, clean, two-stroke engine oil into the cylinder through the spark plug hole.
 - A. Place a clean cloth over the spark plug hole.
 - B. Pull the recoil starter handle 2-3 times to distribute the oil inside the engine.
 - C. Observe the piston location through the spark plug hole. Pull the recoil starter handle slowly until the piston reaches the top of its travel and leave it there.
8. Install the spark plug (do not connect ignition cable).

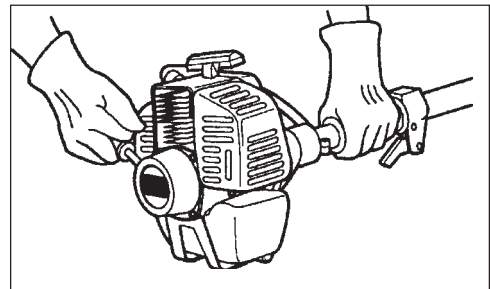
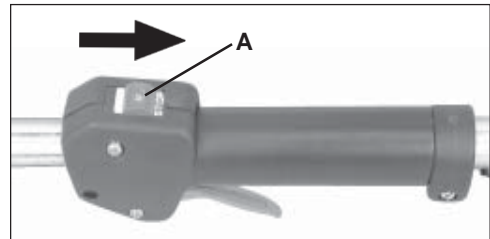

NOTES

SERVICING INFORMATION

PARTS

Genuine ECHO Parts and ECHO REPOWER™ Parts and Assemblies for your ECHO products are available only from an Authorized ECHO Dealer. When you do need to buy parts **always** have the Model Number and Serial Number of the unit with you. You can find these numbers on the engine housing. For future reference, write them in the space provided below.

Model No. _____ Type No. _____ S/N. _____

SERVICE

Service of this product during the warranty period must be performed by an Authorized ECHO Service Dealer. For the name and address of the Authorized ECHO Service Dealer nearest you, ask your retailer or call: 1-800-432-ECHO (3246). When presenting your unit for Warranty service/repairs, proof of purchase is required.

ECHO CONSUMER PRODUCT SUPPORT

If you require assistance or have questions concerning the application, operation or maintenance of this product you may call the ECHO Consumer Product Support Department at 1-800-673-1558 from 8:00 am to 5:00 pm (Central Standard Time) Monday through Friday. Before calling, please know the model and serial number of your unit to help your Consumer Product Support Representative.

WARRANTY CARD

This card is our means of registering all original owners of ECHO equipment. The card plus proof of purchase provides you the assurance that authorized warranty work will be done. It also provides a direct link between you and ECHO if we find it necessary to contact you.

ADDITIONAL OR REPLACEMENT MANUALS

Safety Manuals are available, free of charge, from your ECHO dealer or by contacting Echo Incorporated, 400 Oakwood Road, Lake Zurich, IL 60047.

Operator's and Parts Manuals are available for purchase from your ECHO dealer or directly from ECHO. [See ordering instructions below.]

MANUAL ORDERING INSTRUCTIONS

To obtain a Parts Catalog or Operator's Manual send a check or money order for \$2.00 per Parts Catalog or \$1.50 per Operator's Manual made payable to ECHO, INCORPORATED. State on a sheet of paper the model number and serial number of the ECHO unit you have, part number of the manual (if known), your name and address and mail to address above.

Available Parts Lists

SRM-2100SB TYPE 1E S/N 001001 & UP
SRM-2400SB TYPE 1E S/N 563000 & UP

PART NUMBER 99922202870
PART NUMBER 99922202871

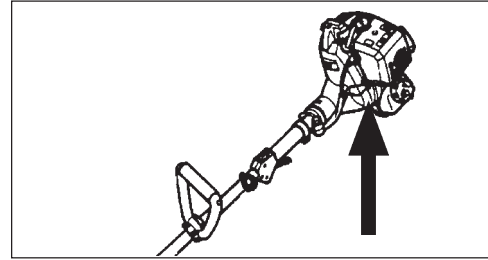

DEALER?
Call
1-800-432-ECHO

**CONSUMER PRODUCT
SUPPORT**
1-800-673-1558
8 - 5 Mon - Fri C.S.T.

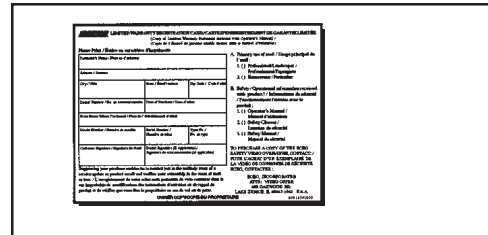

ECHO Incorporated
400 Oakwood Road
Lake Zurich, IL 60047

Technical Publications Orders

ECHO
ECHO, INCORPORATED
400 OAKWOOD ROAD
LAKE ZURICH, IL 60047

Free Manuals Download Website

<http://myh66.com>

<http://usermanuals.us>

<http://www.somanuals.com>

<http://www.4manuals.cc>

<http://www.manual-lib.com>

<http://www.404manual.com>

<http://www.luxmanual.com>

<http://aubethermostatmanual.com>

Golf course search by state

<http://golfingnear.com>

Email search by domain

<http://emailbydomain.com>

Auto manuals search

<http://auto.somanuals.com>

TV manuals search

<http://tv.somanuals.com>