

ECLIPSE®

by FUJITSU TEN

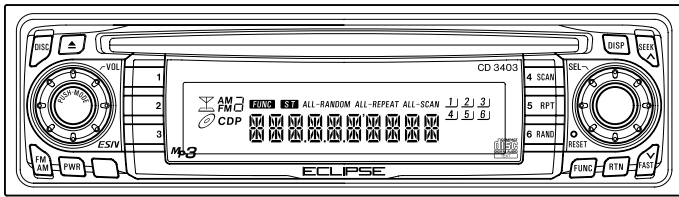

MODEL **CD3403**

ESN E3 High-Power CD Receiver with
MP3 Decoder

OWNER'S MANUAL

We appreciate your purchase of this receiver.
Please read through this manual for correct operation.
We suggest that after reading it you keep this manual
in a safe place for future reference.

For your safety in using the CD3403

Warnings and caution signs, illustrated below, are posted throughout this manual as well as on the CD3403. They show safe and correct ways to handle the product so as to prevent personal injury to you and others and avoid damage to property.

Before reading through the manual, take time to read through and learn the important information listed in this section.



Warning

This sign indicates a situation in which incorrect handling through disregard of a sign might result in death or serious personal injury.



Caution

This sign indicates a situation in which incorrect handling through disregard of a sign might result in personal injury or may result solely in damage to property.



Warning

- Do not modify this system for use other than that specified herein. Also, do not deviate from the installation procedures described herein; Eclipse will not be held liable for damages including, but not limited to serious injury, death or property damage resulting from installations that enable unintended operation.
- This unit is intended for operation in DC 12-volt, negative-grounded vehicles only. Never use it in 24-volt vehicles such as heavy trucks or diesel cars with cold-region specifications.
- Do not change CDs while driving. Doing so may result in an accident.



Warning

- Do not place the vinyl storage bag over a person. It may cause a serious accident or death by suffocation.
- Do not adjust the controls while driving the car. To adjust the controls, stop the car in a safe location.
- To prevent accidents, store batteries for the remote control out of the reach of small children. In case a child swallows a battery, consult a physician immediately.
- Do not disassemble or rebuild this product. Doing so may cause an accident, fire or electrical shock.
- When it is necessary to replace the fuse, always use a fuse of the correct rating (number of amperes). Use of fuses with higher amperage ratings may cause a fire.
- Do not operate the product in a malfunctioning condition, for instance, when the audio does not play. Doing so may result in an accident, fire or electrical shock.
- If an abnormal situation occurs, such as foreign matter entering or liquid splashing on the product, or smoke or a strange odor emitting from the unit, shut off the product immediately and consult the dealer from whom you purchased it. Continued operation may cause an accident, fire or electrical shock.
- Do not install this product in locations where it may obstruct the driver's view, or where it may endanger passengers in the vehicle. Otherwise, an accident or injury may result.
- Do not install this product in locations where it may interfere with the operation of the steering wheel, shift lever, brake pedal, etc. Otherwise, an accident or injury may result.
- When installing this product, never use existing nuts or bolts that secure parts of the fuel tank, or the steering or braking systems. Otherwise improper steering or braking or a fire may result.

 **Warning**

- To prevent a short circuit from occurring, disconnect the battery's negative terminal before installing this product. Otherwise, an electric shock or injury may result.
- When using an existing nut and/or bolt from the vehicle to ground this product, do not use any that secure parts of the steering or braking systems. Otherwise, an accident may result.
- Bundle cables and harnesses with electrical tape or wire ties to prevent them from interfering with moving parts. If they should entangle the steering wheel, shift lever or brake pedal, an accident may result.
- Never supply power to another electrical appliance by splicing or tapping into this product's power lead (wire). Otherwise, the current capacity of the wire will be exceeded, resulting in a fire or electric shock.
- Never attempt to disassemble or modify the product. Otherwise, an accident, fire or electric shock may result.
- When installing the product into a vehicle with a passenger side air bag, do not secure it to the air bag's cover or in places where it may impede air bag deployment. Otherwise, proper air bag operation may not be ensured in the event of an accident, causing injury or death.
- When making holes using a drill or similar tool, be sure to wear protective eyewear. Otherwise, an injury such as loss of eyesight may result.
- Exposed wires must be insulated with electrical tape. Otherwise, a short circuit, fire, or electric shock may result.



Caution

- Play the audio at a moderate volume level that permits you to hear sounds from outside the car. Driving without being able to hear outside sounds may result in an accident.
- Keep foreign objects out of the disc slot. They may cause fire or electrical shock. Another possibility is that discs may be damaged or become stuck.
- Do not stick your fingers or hands into the disc slot. Doing so may cause personal injury.
- This product must be operated only as on-board equipment, or it may cause electrical shock or injury.
- Do not play distorted sounds for long periods of time; the speakers may overheat and cause a fire.
- This product uses an invisible laser light. In case a problem develops, be sure to consult the dealer from whom you purchased the product. Do not disassemble or rebuild the unit; rebuilding it may expose you and others to a dangerous laser emission (which would damage eyesight) or cause an accident.
- Never use batteries other than those specified. Do not mix new and old cells. Doing so may cause a fire or personal injury due to a battery explosion or chemical leaks.
- Pay attention to the (+) and (-) polarity of the battery when installing them in the product. Incorrect installation may cause personal injury or product damage spoilage due to a battery explosion or chemical leakage.
- For best results, this product should be installed by a professional installer.
Contact the dealer whom you purchased the product for an appointment.
- When installing this product, be sure to use the supplied mounting hardware. If parts other than those supplied are used, the unit may be damaged internally, or may not be held in place securely and become dislodged.



Caution

- Avoid installing this product in places where it may get wet, such as near windows, or in places that are moist or dusty. Presence of liquid, moisture or dust inside this product can cause short circuiting, resulting in smoke or fire.
- Do not install this product in locations where it cannot be fastened securely, such as places subject to frequent vibration. Otherwise, it may become dislodged and cause an accident or injury.
- Do not block this product's vent or heat sink. If either is blocked, excessive heat build-up may occur and cause a fire.
- If this product is not connected properly, a short circuit, fire or accident may occur.
- When routing cables, use care so that they do not contact sharp metal parts such as brackets or screw tips. Otherwise, a short circuit, electric shock, fire or accident may result.
- Do not obstruct the vent on this product. If blocked, excessive heat build-up may occur and cause a fire.

Table of Contents

<i>Operating precautions</i>	10
Notes on operation	10
About compact discs	11
About cleaning a CD	13
<i>Names of controls and parts</i>	14
<i>ESN (Key CD) security operating procedure</i>	15
How to program the Key CD	15
How to cancel the Key CD	16
How to change the Key CD	17
How to resume normal operation (ESN security lock out)	17
What happens if an incorrect CD is inserted?	18
How to turn the security indicator on/off	19
How to read the Electronic Serial Number	19
<i>Basic operation</i>	20
Turning the power on and off	20
Listening to a CD	21
Listening to the tuner	22
Adjusting audio volume	22
Switching audio control modes	23
Enabling the loudness control	24
Making changes with Function Mode	25
<i>How to operate the CD player</i>	27
Listening to CDs	27
Advancing to the next track or returning to the beginning of the track being played	28
Fast Forward/Rewind	28
Playing the beginning of tracks (SCAN)	28
Repeating the same track (REPEAT)	29
Playing tracks in random order (RANDOM)	29
Ejecting the disc	30
Displaying CD TEXT	30

How to operate the MP3 player 31

About MP3	31
Listening to MP3 file	34
Advancing to the next track (file) or returning to the beginning of the track (file) being played	35
Fast Forward/Rewind	35
Skipping to the next or previous folder	35
Return to the root directory of the CD	35
Playing the beginning of files (SCAN)	36
Repeating the same file (REPEAT)	36
Playing files in random order (RANDOM)	37
Displaying title	37

How to operate the tuner 38

Tuning to a station	38
Entering stations into memory automatically (The automatic preset mode: ASM)	39
Manually setting stations into memory	40
Preset station scan	41
Switching the display	41
FM reception characteristics	42

How to use an optional Card remote control 44

Precautions in use of the remote control	44
Cleaning the remote control	44
Turning the power on/off	45
Adjusting the audio volume	45
Switching playback modes	46
How to play the tuner	46
How to play CDs	47
Replacing the battery	49

How to use an optional NOB remote control 50

Turning the power on/off	50
Adjusting the audio volume	50
Switching playback modes	51
How to play the tuner	51
How to play CDs	52
Replacing the battery	54

<i>If you have a question:</i>	56
Displayed information (for troubleshooting)	57
<i>Specifications</i>	60
<i>Before installation</i>	61
Components	61
Installation angle	62
<i>Mounting instruction</i>	63
Mounting the main unit	63
Names of lead wires and destinations	65
System	66

Operating precautions

<Your CD3403 will perform well over a long period of time through correct handling and care.>

Notes on operation

- For your safety, play only at volume levels that allow outside sounds to be heard.

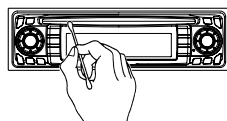
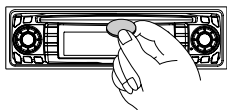

- We recommend using with this player a disc with the logo shown to the left.
- You can play music CDs (CD-R/CD-RW) on this player. Be sure to use discs that have been properly processed.

Depending on the editing equipment used, some discs may not play properly.

- Do not insert anything other than a CD into the disc slot.

Do not insert any foreign objects, such as coins or credit cards, into the disc slot. Be especially watchful of children's mischief in this regard.

- Avoid severe mechanical shock.

When the player is subjected to severe vibration while traveling over a rough surface, playback may be intermittent. When a situation like this occurs, resume playback after returning to a smoother road.

- About dew condensation.

In cold or rainy weather, just as the interior glass surface gets fogged, dew (water condensation) may also settle on the deck. When this occurs, disc playback may become intermittent or impossible. Dehumidify the air in the vehicle for a while before resuming playback.

- Cleaning the disc slot.

The disc slot tends to get dusty. Clean it occasionally to prevent accumulated dust from scratching the discs.

About compact discs

- The signal recorded on a compact disc is read by a laser beam, so nothing touches the disc surface. A scratch on the recorded surface or a badly warped disc may cause deteriorated sound quality or intermittent playback. Observe the following precautions to ensure high quality sound performance:

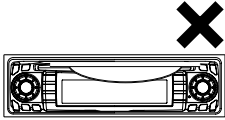

- Do not leave an ejected disc in the disc slot for very long; the disc may warp. Discs should be stored in their cases and kept away from high temperature and humidity.

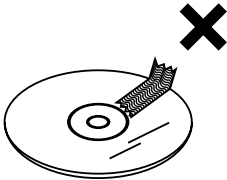

- Do not stick a piece of paper or tape on, nor write on or scratch either side of a disc.

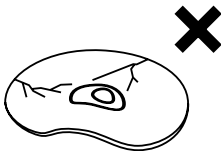

- Discs spin at a high speed inside the deck. Keep cracked or warped discs out of the player to avoid damaging it.

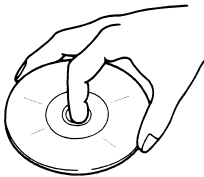

- Avoid touching the recorded surface when handling a disc; handle discs by their edges.

About brand new CDs

- You may notice that some brand new discs are rough around the center hole or outside edge. Remove the rough edges with the side of a ballpoint pen, etc. Rough edges may prevent proper loading in the deck. Flakes from the rough edges may also stick to the recorded surface and interfere with playback.

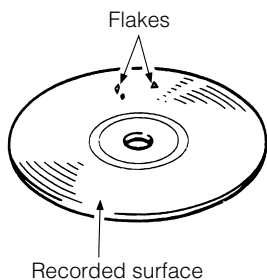
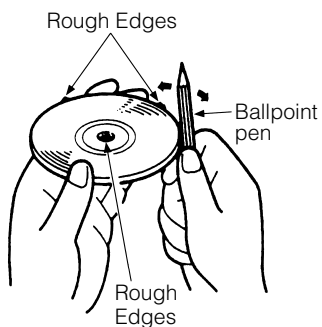
**About CD accessories**

- Do not use accessories (stabilizers, protective seals, laser lens cleaners, etc.) sold for "improving sound performance" or "protecting CDs." The changes in CD thickness or outside dimensions made by these accessories may cause problems in the player.

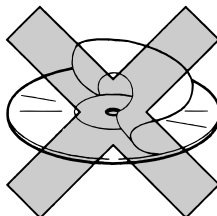

- Please be sure NOT to attach any ring-shape protector (or other accessory) to your discs. Those protectors are commercially available and said to protect disc and to improve sound quality (and antivibration effect), but they can do more harm than good in regular uses. The most common problems are Insert/Eject related problems and "No playback" problems due to the protector ring that came off in the disc mechanism.

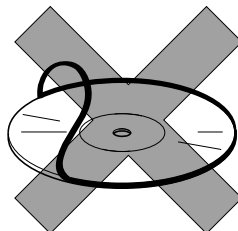

About borrowed CDs

- Do not use a CD with glue or remnants of adhesive tape or labels. They may cause the CD to get stuck inside or damage the deck.

How to remove CDs

- When removing the ejected disc, pull it straight out along the slot. Pressing downward in the process may scratch the recorded surface of the disc.

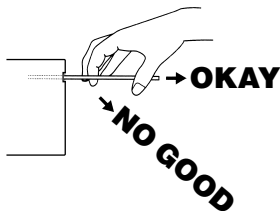
**About irregularly-shaped CDs**

- Specially-shaped CDs, like heart-shaped or octagonal CDs, cannot be played. Do not attempt to play them, even with an adapter, since they may damage the player.

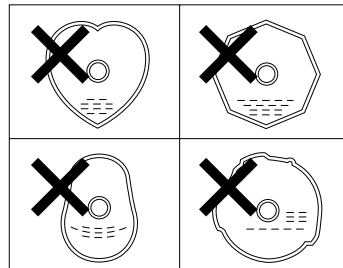
**About cleaning a CD**

- Use a commercially available compact disc cleaner to clean a CD, wiping lightly from the center to the edge.

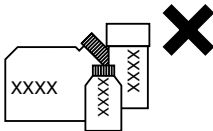

- Do not use benzine, thinner, LP record spray or other cleaners on CDs. They may damage a CD's finish.

Names of controls and parts

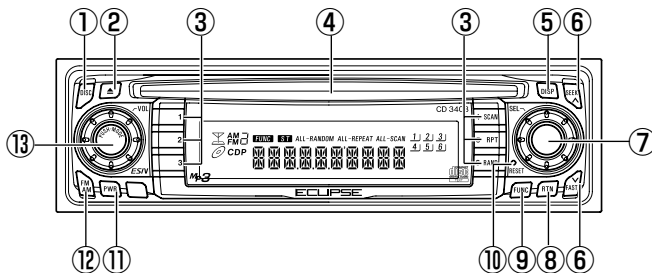

①	[DISC] button	Switches disc modes and switches.
②	[▲(EJECT)] button	Ejects compact disc.
③	Buttons [1] to [6]	Selects radio preset channels and performs disc mode functions.
④	Disc slot	Inserts compact discs.
⑤	[DISP] button	Switches screen display.
⑥	[SEEK^/FAST V] button	Automatically finds radio reception and fast forward/rewind.
⑦	[SEL] button	Selects radio stations and CD tracks.
⑧	[RTN] button	Returns to previous screen.
⑨	[FUNC] button	Turns function mode ON/OFF.
⑩	[RESET] button	Resets deck functions to default settings.
⑪	[PWR] button	Turns deck power ON/OFF.
⑫	[FM AM] button	Switches to radio mode and switches radio bands.
⑬	[AUDIO CONTROL] button	Adjusts volume and performs other functions.

ESN (Key CD) security operating procedure

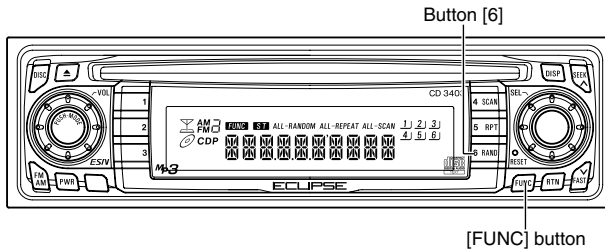

How to program the Key CD

- 1 Check that the Power is OFF.
- 2 Press and hold button [6], then the [FUNC] button, and hold both for more than one second.
A [SEC] message appears, then in two seconds it will change to [DISC].
The CD3403 is now ready to accept your Key CD in the CD slot.
- 3 Insert the CD into the slot.
A [SEC] message appears, then the Key CD is ejected.



ATTENTION

- If there is a problem with the inserted CD, an [ERR] message will appear for two seconds and the CD will be ejected. Reinsert the ejected CD.
- If a CD causes the [ERR] message to appear twice in a row, try another CD.
- The Security indicator will flash whenever the vehicle's ignition is switched off.

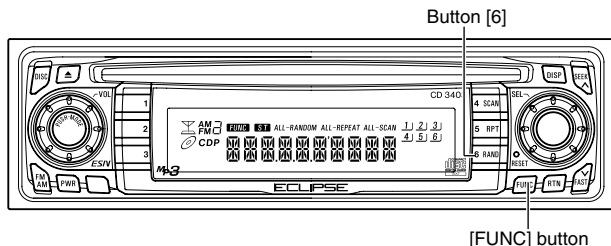

How to cancel the Key CD

- 1 Turn OFF the Power.
- 2 Press and hold button [6], then the [FUNC] button, and hold both for more than one second.

A [SEC] message appears, then in two seconds it will change to [DISC].

The CD3403 is now ready to accept your Key CD in the CD slot.

- 3 Insert your Key CD into the slot.

A [CANCEL] message appears, then the Key CD is ejected. The Key CD is cancelled.



- This process cancels the protection for the ESN deck.
- If power to the ESN deck is disconnected, then reconnected, a Key CD will not need to be inserted in order to return the unit to normal operation.
- Inserting a CD other than the Key CD will not cancel the protection. Instead, the normal CD playback mode will activate.

How to change the Key CD

- 1** First, cancel the existing Key CD.

Refer to “How to cancel the Key CD.”

- 2** Next, program a new Key CD.

Refer to “How to program the Key CD.”

How to resume normal operation (ESN security lock out)

If power is disconnected while ESN security is active (a Key CD was programmed), operation is disabled until power is restored and the unit unlocked. Follow this procedure to resume normal operation.

- 1** When the power is turned on after disconnecting the battery power, a [SEC] message will appear for two seconds. Thereafter, the message changes to [DISC] and the CD3403 is ready to accept your Key CD into the slot.

- 2** Insert your Key CD.

If the correct CD is inserted, an [OK] message will appear for two seconds and the CD will begin playing.



ATTENTION

- If an incorrect CD is inserted, an [ERR] message will appear for two seconds, after which the CD will be ejected.
- You must use the same CD used for Key CD programming; a duplicate CD may not work properly.

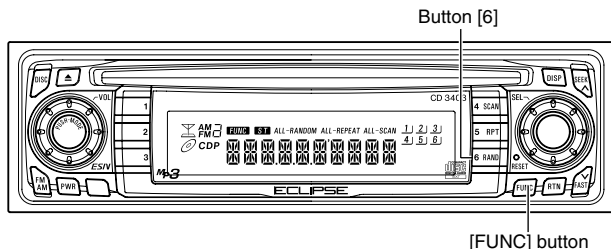

What happens if an incorrect CD is inserted?

- 1** An [ERR] message will be appear, then change to a flashing [DISC], then the CD will be ejected.
You will have five uninterrupted attempts to insert the correct CD.
- 2** After the 5th incorrect attempt, the display reads [HELP].
- 3** If [HELP] appears on the screen, press button [6], then the [FUNC] button, and hold them for five seconds.
- 4** Press the [FUNC] button.

You will have five more attempts the correct disc.



Number of errors: Numbers indicated the number of errors that occurred.

● Note ●

If after 10 tries the correct Key CD is not inserted, the display reads [CALL800]; the unit must be returned to Eclipse to be reset. In this case, please contact your Eclipse dealer for assistance or call Eclipse directly at (800) 233-2216.

Your key CD can be easily forgotten. Write the album name in a reminder note (See Page 69).

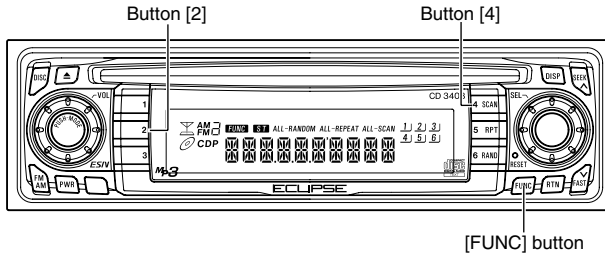

How to turn the security indicator on/off

Once ESN security is activated, the indicator flashes whenever the vehicle's ignition is turned off, warning potential thieves that the unit is protected. However, if you do not want this visible deterrent, it may be turned off.

- 1** With the power OFF, press button [2], then the [FUNC] button and hold both for more than one second.
- 2** [IND. FLASH] or [IND. -----] appears on the display.

[IND. FLASH] means the security indicator will flash when the vehicle's ignition is off, and [IND. -----] means it will not. Repeat the above steps to reactivate the flash mode.

How to read the Electronic Serial Number

- 1** Turn OFF the Power.
- 2** Press button [4], then the [FUNC] button, and hold both for more than one second.

[ESN] appears on the display, followed by an eight-digit number; this number is your electronic serial number (ESN). You may use this number to identify your Eclipse CD3403 in the event it is recovered after being stolen.

Basic operation

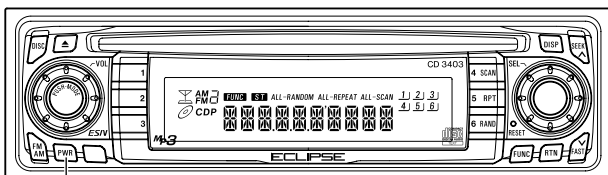

[PWR] button

This section covers basic operating procedures. For additional details, please refer to the sections on specific functions.

Turning the power on and off

Turning the power on and off.

When the power is turned on, the state used when the power was turned off such as CD and tuner playing is restored.

When the vehicle has no ACC position on the ignition switch, care is needed when turning off the deck. Follow Step 2 or Step 3 when turning off the power.

- 1** When power is OFF, press [PWR] button.
 The power will come ON.
- 2** When power is ON, press the [PWR] button for less than two seconds.
 The power will go OFF and the deck will be in Standby.
- 3** When power is ON, press the [PWR] button for more than two seconds.
 The power will go completely OFF.



If a car is not equipped with an ACC position (for example, a European car), keep the [PWR] button depressed for more than two seconds.

[DISC] button

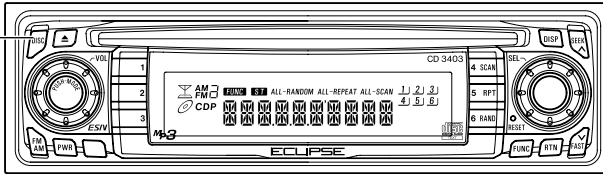

Listening to a CD

- 1 Insert a CD into the disc slot, label side up.

The CD will start playing.



When a CD is already loaded, press the [DISC] button to switch to the CD mode.

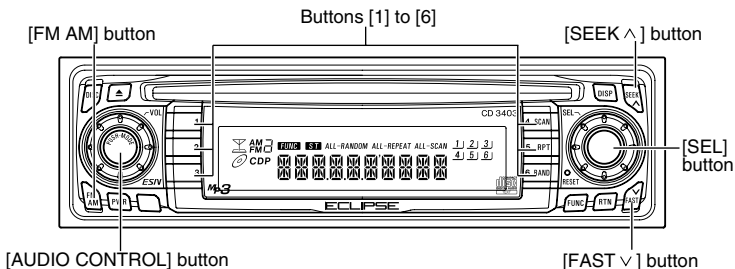

Listening to the tuner

- 1** Press the [FM AM] button.

This will turn the tuner on.
- 2** Press the [FM AM] button to switch to the desired FM or AM bands.

Radio bands will switch from FM1 → FM2 → FM3 → AM in order each time the button is pressed.
- 3** Turn the [SEL] button to the left or right to tune to a station.

Turn to the right: Turns to higher frequencies.
Turn to the left: Turns to lower frequencies.
- 4** Press the [SEEK ^ /FAST ∨] button to start the automatic station search.

[SEEK ^] button: Starts searching toward higher frequencies.
[FAST ∨] button: Starts searching toward lower frequencies



If stations have been stored in memory, pressing a button from [1] to [6] will directly select a station. (Refer to the section "Manually setting stations into memory" on page 40)

Adjusting audio volume

- 1** Turn the [AUDIO CONTROL] button to the left or right.

Turn to the right: Increases the volume.
Turn to the left: Decreases the volume.



Do not adjust the volume or other controls while driving the vehicle. Do so only while parked in a safe location.

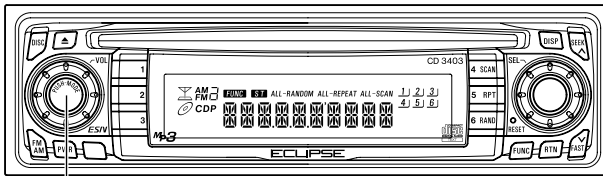

[AUDIO CONTROL] button

Switching audio control modes

Various audio control modes may be fine-tuned using this procedure.

- 1 Press the [AUDIO CONTROL] button for less than one second to select the item to be adjusted.

Modes will switch in the order shown below each time the button is pressed.

→ VOL → BASS → TREB → BAL → FAD →

VOL (VOLUME) Mode

Adjusts volume.

Turn the [AUDIO CONTROL] button to the left or right.

Turn to the right: Increases the volume.

Turn to the left: Decreases the volume.

BASS Mode

Adjusts bass level.

Turn the [AUDIO CONTROL] button to the left or right.

Turn to the right: Emphasizes low sounds.

Turn to the left: Softens low sounds.

TREB (TREBLE) Mode

Adjusts treble level.

Turn the [AUDIO CONTROL] button to the left or right.

Turn to the right: Emphasizes high sounds.

Turn to the left: Softens high sounds.

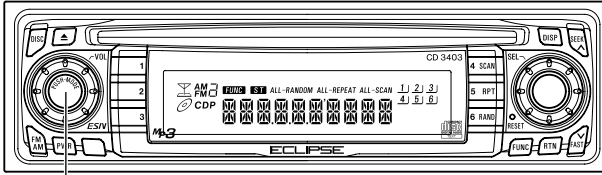

[AUDIO CONTROL] button

BAL (BALANCE) Mode

Adjusts left/right speaker balance.

Turn the [AUDIO CONTROL] button to the left or right.

Turn to the right: Emphasizes right speakers.

Turn to the left: Emphasizes left speakers.

FAD (FADER) Mode

Adjusts front/rear speaker balance.

Turn the [AUDIO CONTROL] button to the left or right.

Turn to the right: Emphasizes front speakers.

Turn to the left: Emphasizes rear speakers.

Enabling the loudness control

The loudness control may be turned on to emphasize low and high frequencies at low volume levels.

Loudness compensates for the apparent weakness of low and high frequencies at low volume by boosting the bass and treble levels.

- 1 Press and hold the [AUDIO CONTROL] button until the [LOUD ON] display appears on the screen.



To disable the loudness feature, repeat the above procedure to display the [LOUD OFF] indication.

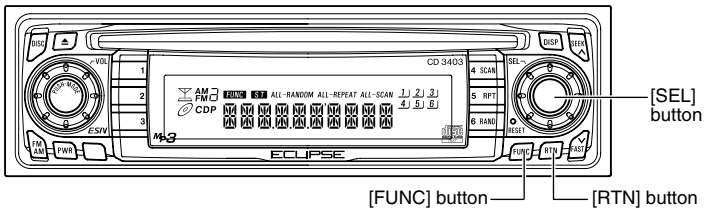

Making changes with Function Mode

A variety of settings can be changed.

- 1 Press the [FUNC] button.

The function mode is activated.

- 2 Turn [SEL] button in either direction to display setting items for selection.

Setting items will be displayed in the following order when the [SEL] button is turned to the right.

→ GUIDE TONE → CLOCK ADJ →

Disabling the guide tone feature (for button operation)

The receiver is set at the factory to emit a beep tone in response to button operation. The guide tone feature may be disabled in the following procedure:

- 1 Turn [SEL] button to select GUIDE TONE.

- 2 Press the [SEL] button.

The Guide Tone Mode will be switched ON/OFF.

- 3 Turn [SEL] button to select ON or OFF.

- 4 Press the [RTN] button.

At this time, other adjustments can also be made in Function Mode.

- 5 Press the [FUNC] button to exit Function Mode.

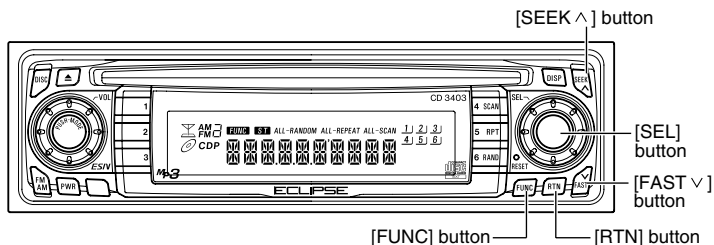

Setting the Time

This receiver uses the 12-hour display notation.

- 1 Turn [SEL] button to select CLOCK ADJ.**
- 2 Press the [SEL] button.**
The clock adjustment mode is activated.
- 3 Turn [SEL] button to display the item to be selected for adjustment.**
Hours, minutes or exact hour will be switched each time the button is turned.
- 4 Press the [SEEK ^ /FAST v] button.**
[SEEK ^] button: Turns the time forward.
[FAST v] button: Turns the time back.
To set the clock to 0 minutes, 0 seconds (an exact hour), press the [SEEK ^ /FAST v] button.
For example:
At 3:29: Pressing the [SEEK ^ /FAST v] button returns to 3:00.
At 3:30: Pressing the [SEEK ^ /FAST v] button advance to 4:00.
- 5 Press the [RTN] button.**
At this time, other adjustments can also be made in Function Mode.
- 6 Press the [FUNC] button to exit Function Mode.**

How to operate the CD player

[DISC] button

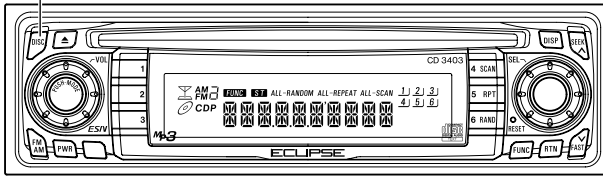

First press the [DISC] button to switch to the disc mode. It is assumed here that a CD has already been loaded into the unit.

Listening to CDs

- 1 Press the [DISC] button.

This starts CD play.



Playback may be intermittent when there is a scratch on a CD or when the recorded side is dirty.

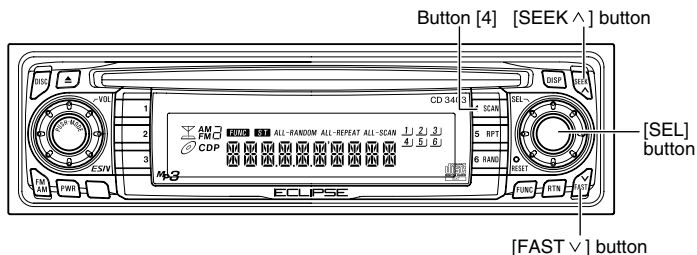

Advancing to the next track or returning to the beginning of the track being played

- 1 Turn the [SEL] button to the left or right.

Turn to the right: Advances to the next track.

Turn to the left: Returns to the beginning of the track being played. (Repeat turning for previous tracks.)

Fast Forward/Rewind

Fast forward or rewind the song currently being played.

- 1 Press and hold the [SEEK ^] or [FAST v] button.

[SEEK ^] button: Fast forward.

[FAST v] button: Rewind.

Playing the beginning of tracks (SCAN)

- 1 Press button [4].

Pressing the button causes the player to move up to the next track and play it for 10 seconds, then move up to the next track and play it for 10 seconds, and so on until the button is pressed again.



- To continue playing a desired track, press the button again to stop scanning.
- After the entire disc is scanned once, ordinary playback starts from the point where scanning started.

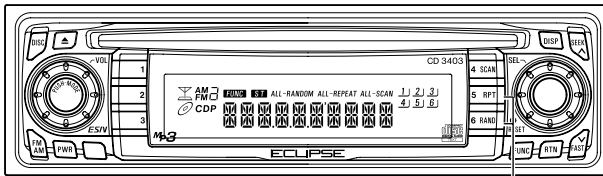

Buttons [5] and [6]

Repeating the same track (REPEAT)

- 1 Press button [5] to repeat the track being played.

To cancel, press button [5] again.

Playing tracks in random order (RANDOM)

- 1 Press button [6] to play the tracks in random order.

To cancel, press button [6] again.



ATTENTION

- Doing random playback, press button [5] to repeat the track being played. To cancel repeat play (go back to random play), press button [5] again.
During playback a particular track: The track being played is played repeatedly.
During searching: The following track is played repeatedly.
- Occasionally the same track happens to be played (selected) two or more times in a row; this is normal operation and is no sign of a problem.
- When any of the functions - "Playing the beginning of tracks," "Repeating the same track" and "Playing tracks in random order" - is selected, a message such as [SCAN], [REPEAT] or [RANDOM] appears on the display to verify the current function.

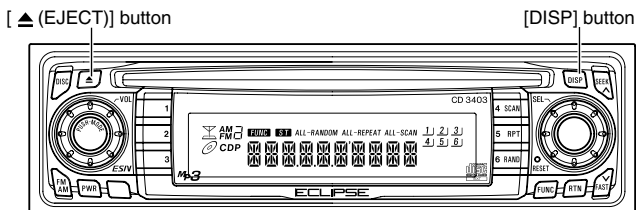

Ejecting the disc

- 1 Press the [▲ (EJECT)] button.

Disc is ejected.

Displaying CD TEXT

Only the built-in CD player supports CD TEXT. If the CD came with a logo shown below, it is recorded with a disc title and track titles. These information will be displayed during playback.



- 1 Press the [DISP] button.

Each time the button is pressed, the following will be displayed in order.

Elapsed time → Disc title/Track title* → Clock

*: The display are shows a maximum of 10 characters and then scrolls to display the remaining characters.

After the disc title is displayed, the track title will be displayed by scrolling. After the track title is scrolled the display will be fixed.

How to operate the MP3 player

About MP3



The making of MP3 files by recording from sources such as broadcasts, records, recordings, videos and live performances without permission from the copyright holder for uses other than personal enjoyment is prohibited.

What is MP3?

MP3 (MPEG Audio Layer III) is a standard format for audio compression technology. By using MP3, a file can be compressed to one-tenth the size of the original.

This deck has limitations on MP3 file standards and recorded media and formats that can be used.

Playable MP3 file standards

- Supported standards: MPEG-1 Audio Layer III
MPEG-2 Audio Layer III
MPEG-2.5 Audio Layer III
- Supported sampling frequencies: 32, 44.1, 48 (kHz)
- Supported bit rate: 8, 16, 24, 32, 40, 48, 56, 64, 80, 96, 112, 128, 160, 192, 224, 256, 288, 320 (kbps)
 - * Supports VBR.
 - * Does not support free format.
- Supported channel modes: stereo, joint stereo, dual channel, monaural

ID3 tags

MP3 files have an "ID3 Tag" that allows input of information so that data such as song title and artist can be saved.

This deck supports ID3v.1.0 and ID3v.1.1 tags.

Media

Media capable of playing MP3 includes CD-ROM, CD-R and CD-RW discs. Compared to CD-ROM media commonly used for music discs, CD-R discs are fragile in high temperature/high humidity environments and one section of the CD-R may become incapable of playback. Fingerprints or scratches on the disc may prevent playback or cause skipping during playback. Sections of a CD-R may deteriorate if left inside a vehicle for long periods of time. It is also recommended that CD-R discs be kept in a light-blocking case because the discs are vulnerable to ultra-violet light.

Format of discs

The format of discs to be used must be ISO9660 Level 1 or Level 2.

Control items for this standard are as follows:

- Maximum directory layers: 8 layers
- Maximum characters for folder names/file names: 40 (including "." and 3 letter file extension)
- Allowable characters for folder names/file names: A~Z, 0~9, _ (underscore)
- Number of files/folders possible on a single disc: 512

[Configuration example for CD supporting MP3]

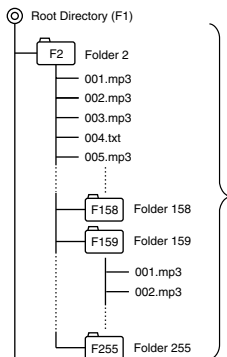

Number of files/folders possible on a single disc is 512.

Files aside from MP3 files (Example: 004.txt) also count as single files.

- Total number of folders possible on a single disc: 255
- Maximum folders this deck can recognize: 255*

*: A root directory is counted as one folder.

File names

Only files with the MP3 file extension ".mp3" can be recognized as MP3 and played. Be sure to save MP3 files with the ".mp3" file extension. The "MP" letters of the file extension will be recognized whether entered as uppercase letters or lowercase letters.



If the ".mp3" file extension is attached to a file other than an MP3 file, that file will be mistakenly recognized by the deck as an MP3 file and played, resulting in loud noise output that can damage the speakers. Be sure to avoid attaching the ".mp3" file extension to files that are not MP3 files.

Multi-sessions

Multi-sessions are supported, and playing of CD-R and CD-RW discs with annotated MP3 files is possible. However, when "Track at once" has been written, close the session or process the warning message. Standardize the format of each session without changing the format.

Playing MP3

When a disc with recorded MP3 files is inserted, the deck first checks all the files on the disc. No sound is output while the deck is checking the files on the disc. It is recommended that the disc be recorded without files other than MP3 files and without unnecessary folders in order to speed up the checking of disc files by the deck.

MP3 playing time display

It is possible that playing time will not be correct, depending on the writing condition of the MP3 file.

* It is possible that playing time will not be correct when VBR Fast Up/Down is operated.

Display order of MP3 file/folder names

Names of MP3 folders and files within the same level are displayed in the following order.

1. MP3 folders displayed first, by ascending order of numbers, letters.
2. Files displayed next, by ascending order of numbers, letters.

[DISC] button

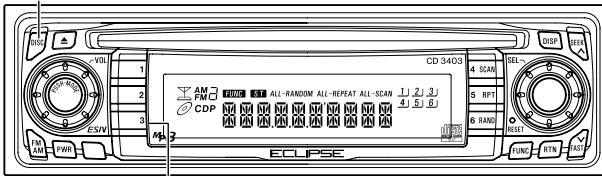

Button [3]

Listening to MP3 file

- 1 Press the [DISC] button.

This starts MP3 file play.



Playback may be intermittent when there is a scratch on a CD or when the recorded side is dirty.

● Note ●

When music data recorded in the normal way (CD-DA) is present on the same disc with MP3 music files, the normally recorded music data will be played. To listen to the MP3 music files, press button [3].

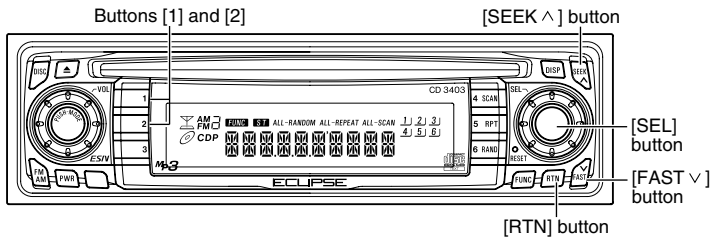

Advancing to the next track (file) or returning to the beginning of the track (file) being played

- 1 Turn the [SEL] button to the left or right.

Turn to the right: Advances to the next track (file).

Turn to the left: Returns to the beginning of the track (file) being played.

Repeat turning for previous tracks (files).

Fast Forward /Rewind

Fast forward or rewind the song currently being played.

- 1 Press and hold the [SEEK ^] or [FAST ∨] button.

[SEEK ^] button : Fast forward.

[FAST ∨] button : Rewind.

Skipping to the next or previous folder

- 1 Press button [1] or [2].

Button [1] : Selects the next folder.

Button [2] : Selects the next lower folder.

Return to the root directory of the CD

In the root directory, when a file cannot replay, the system will return to the first file that can perform a replay. (In the configuration example, the file is returning to 001.mp3. See page 32.)

- 1 Press the [RTN] button.

Buttons [4] and [5]

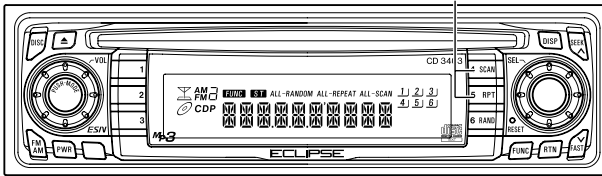

Playing the beginning of files (SCAN)

- 1 Press button [4].

Press the button briefly to play just the first 10 seconds of each song for all the files in the current folder being played. Pressing the button until [ALL SCAN] is displayed will play just the first 10 seconds of the first song in each folder.



- To continue playing a desired track, press the button again to stop scanning.
- After the entire disc is scanned once, ordinary playback starts from the point where scanning started.

Repeating the same file (REPEAT)

- 1 Press button [5].

Press the button briefly to repeat the file being played. Pressing the button until [ALL REPEAT] is displayed will repeat all the files in the current folder being played. To cancel, press button [5] again.

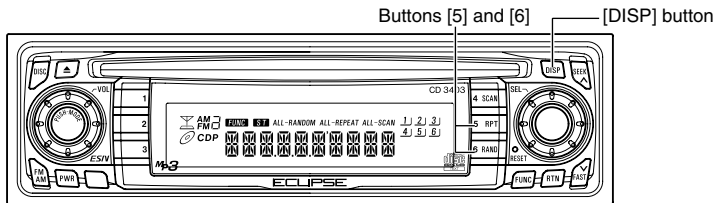

Playing files in random order (RANDOM)

1 Press button [6].

Press the button briefly to randomly play the files in the current folder being played.

Pressing the button until [ALL RANDOM] is displayed will randomly play the files in all the folders.

To cancel, press button [6] again.



ATTENTION

- Occasionally the same file happens to be played (selected) two or more times in a row; this is normal operation and is no sign of a problem.
- Doing random playback, press button [5] to repeat the file being played. To cancel repeat play (go back to random play), press button [5] again.
 - During playback a particular file: The file being played is played repeatedly.
 - During searching: The following file is played repeatedly.

Displaying title

1 Press the [DISP] button.

Each time the button is pressed the following will be displayed in order.

Elapsed Time → Folder Name/File Name* → Tag → Clock

*: The display area shows a maximum of 10 characters and then scrolls to display the remaining characters.

After the folder name is displayed, the file name will be displayed by scrolling. After the file name is scrolled, the display will be fixed.

How to operate the tuner

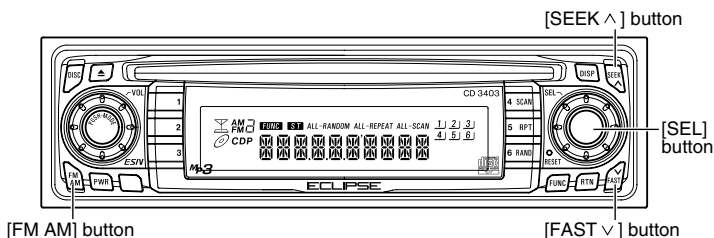

First, press the [FM AM] button to start tuner operation.

There are automatic and manual methods for setting stations in memory. The receiver will accept up to 24 stations in memory: six in AM and 18 in FM (6 each for FM1, FM2 and FM3.) (Initial setting)

Tuning to a station

- 1** Press the [FM AM] button to switch to the desired FM or AM bands.

Radio bands will switch from FM1 → FM2 → FM3 → AM in order each time the button is pressed.
- 2** Turn the [SEL] button to the left or right to tune to a station.

Turn to the right: Tunes to higher frequencies.
Turn to the left: Tunes to lower frequencies.
- 3** Press the [SEEK ^ /FAST v] button to start the automatic station search.

[SEEK ^] button: Starts searching toward higher frequencies.

[FAST v] button: Starts searching toward lower frequencies.



ATTENTION

At times, it may be difficult to maintain optimum reception because the antenna affixed to your vehicle is in motion constantly (relative to the broadcast antenna), encountering continuous variation in the received radio signals' strength. Other factors affecting reception include interference from natural obstacles, sign posts, etc.

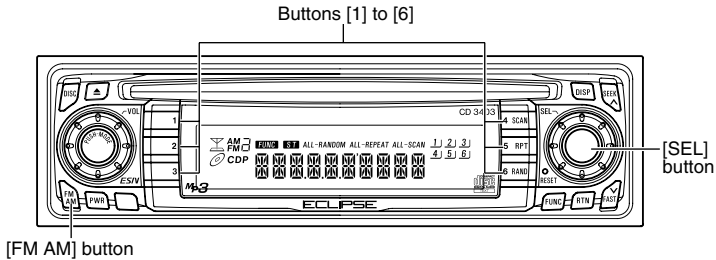

Entering stations into memory automatically (The automatic preset mode: ASM)

- 1 Press the [FM AM] button to switch to the desired FM or AM bands.

Radio bands will switch from FM1 → FM2 → FM3 → AM in order each time the button is pressed.

- 2 Press the [SEL] button for more than two seconds until a beep is heard.

The automatic preset mode starts.

The [ASM ON] indicator on the screen flashes, and stations are automatically entered in memory under buttons [1] to [6].

These buttons are called preset buttons.



- Press any numbered button to select the station whose frequency is indicated right above the button.
- When a new station is set in memory, the station previously set in memory will be deleted.
- If there are fewer than six receivable stations, the stations set in the remaining buttons will be retained.

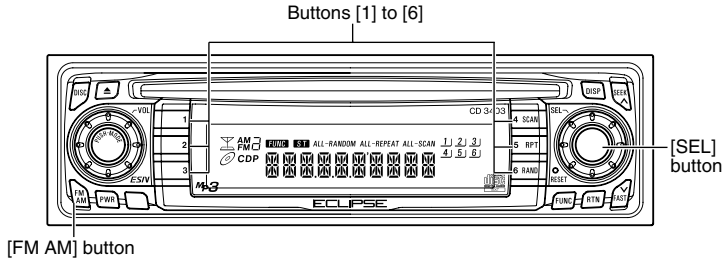

Manually setting stations into memory

This section covers the setting of stations in memory under the numbered buttons.

- 1** Press the [FM AM] button to switch between FM and AM.
- 2** Turn the [SEL] button to the right or left to tune to the station to be entered in memory.
- 3** Select any button, from [1] to [6], and press it for more than two seconds.

The tuned station is now memorized and set in the button selected. Repeat the procedure to set additional manually tuned stations in memory, in turn, for buttons [1] to [6]. These buttons are called the preset buttons.



If the vehicle's battery is disconnected (for repairs to the vehicle or for removing the receiver), all stations in memory will be lost. In such a case, set stations in memory again.

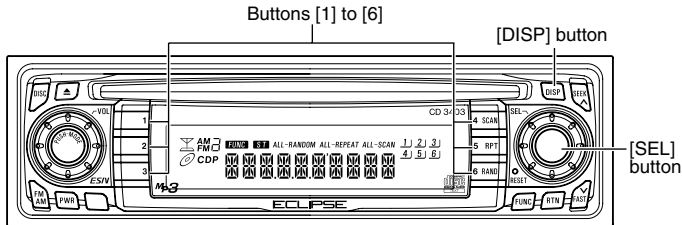

Preset station scan

This function enables reception of all the stations in the preset buttons for five seconds each.

- 1 Press the [SEL] button for less than one second.

[P SCAN] will appear at the top of the display, and stations stored under preset buttons [1] through [6] will be played for five seconds each.

- 2 To stop the preset scan mode at a desired station, press the [SEL] button again.

The receiver will stay tuned to the desired station.

Switching the display

- 1 Press the [DISP] button.

Each press of the button switches the display the clock and current frequency.

FM reception characteristics

In general, FM has much better tonal quality than AM. However, FM and FM stereo reception encounter several characteristic problems not encountered with AM. FM is more difficult to receive than AM in a moving vehicle. The following are explanatory notes on what to expect from FM reception and on how to get satisfactory performance.

FM RECEPTION DIFFERS FROM AM

A characteristic of transmitted signals is that lower frequencies travel further. FM frequencies are much higher than AM's (similar to a ray of light): they won't bend but they will reflect. Often, they will be interrupted by tall buildings, mountains, etc., taking direct and indirect paths to your vehicle's antenna. The distance at which FM stations can be received satisfactorily is usually not nearly as far as that which AM stations can be received.

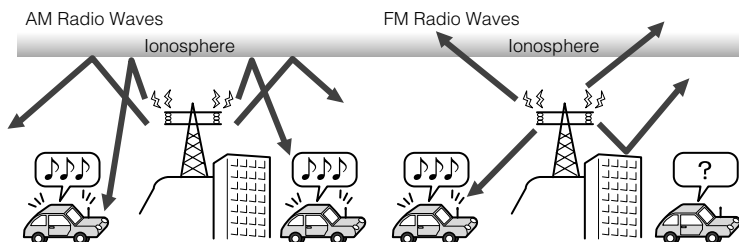

FADING OUT

In weak signal or "fringe" reception areas, FM stations may fade out completely, or fade in and out. When driving in weak signal areas, such as near hills, through valleys or tunnels, among tall buildings, etc., you may encounter unusual noise interference. **THIS IS NOT A TUNER PROBLEM.** In this case, you can only wait until you are in a better reception area, tune to a stronger station, or reduce the treble level.

RECEPTION AREA OF FM BROADCASTS

A home receiver can catch weak FM stereo signals through the use of a tall, directional or ultra-sensitive antenna. In a moving vehicle, the area for good reception is limited because of varying conditions encountered while driving, including the types and heights of broadcast antenna structures, signal strength, engine noise, etc. For best reception with manual antenna, extend the antenna mast as far as possible.

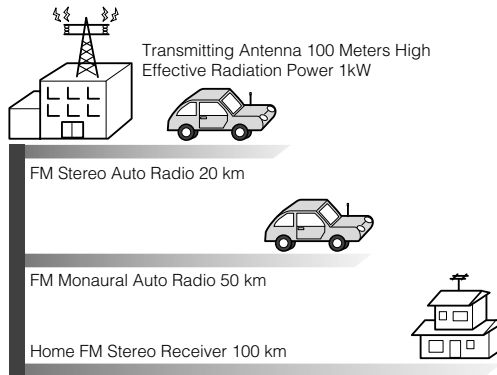

Reception quality varies depending on the power of the FM station, natural and artificial barriers, weather conditions, etc.

MULTIPATH

The reflection characteristics of FM waves cause another problem called multipath—FM wave signals reflecting off of buildings, mountains, etc. When the antenna receives direct and reflected waves at the same time, distortion of sound in the treble range often occurs, such as static or harsh-sounding voices. THIS IS NOT A TUNER PROBLEM. Only moving to another area with a clearer signal path can remedy the situation.

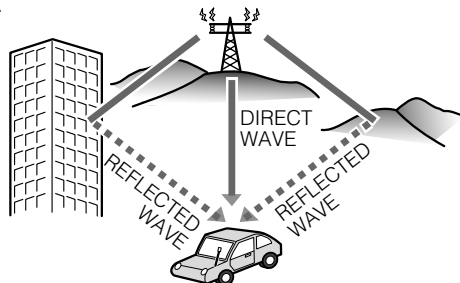

How to use an optional Card remote control

Precautions in use of the remote control

- Be careful when handling the control, especially because it is small and light. Dropping or striking it hard may damage it, wear out the battery or cause a malfunction.
- Keep the remote control free of moisture, dust and water. Do not subject it to shock.
- Do not place the remote control unit where it will get hot, such as on the dashboard or near a heater vent. Allowing the remote control unit to overheat may warp its case or cause other problems.
- Do not operate the remote control unit while driving because doing so could cause an accident.
- When using the remote control, point it directly at the remote control light receptor.
- The light receptor may not operate correctly if it is exposed to bright light such as direct sunlight.
- Be sure to press the [PWR] button on the main unit for more than two seconds to shut it down before leaving the car, or the car battery may be run down. When the main unit is shut down, the remote control will not work.
- Remove the batteries from the remote control unit whenever it is not to be used for a long time.

Cleaning the remote control

- Use a dry cloth to keep the unit clean. If the remote control unit gets extremely dirty, clean it with a cloth moistened in dilute liquid detergent. Do not use alcohol or thinner; these compounds may damage the finish.
- In no event should benzine or thinner be used. These substances will damage the case or finish.

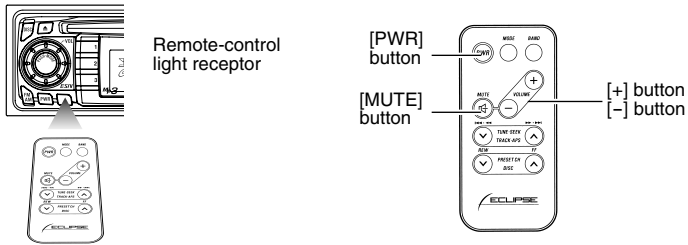

Turning the power on/off

When the power is turned on, the state used when the power was turned off such as CD and tuner playing is restored.

- 1 Press the [PWR] button.

The power turns on or off each time the button is pressed.



When the main unit is shut down, the remote control will not work.

Adjusting the audio volume

- 1 Press the [+] or [-] button.

[+] button: Increases the volume.

[-] button: Decreases the volume.

Cutting the volume instantly (muting)

Press the [MUTE] button to cut the volume or restore it instantly.

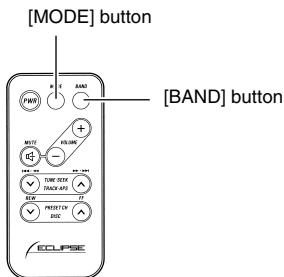

Switching playback modes

- 1 Press the [MODE] button.

Press the button to switch modes in the following sequence:

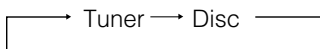

How to play the tuner

Select the tuner mode first.

Selecting the FM/AM band

- 1 Press the [BAND] button.

Each press will switch tuner modes from FM1 → FM2 → FM3 → AM.

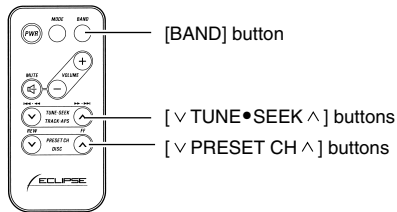

Selecting a station (manually or automatically)

A short tap of the button will allow manual station tuning. Pressing for more than one second will start automatic tuning.

1 Press the [∨ TUNE•SEEK ∧] button.

[∧] button: Tunes to higher frequency stations.

[∨] button: Tunes to lower frequency stations.

Selecting preset stations

A total of six stations may be selected (preset tuning) out of those already set in memory through the main unit. (Refer to "Manually setting stations into memory," page 40.)

1 Press the [∨ PRESET CH ∧] button.

[∧] button: Select the next higher number preset button.

[∨] button: Select the next lower number preset button.

How to play CDs

Select the disc mode first.

Switching disc mode

1 Press the [BAND] button.

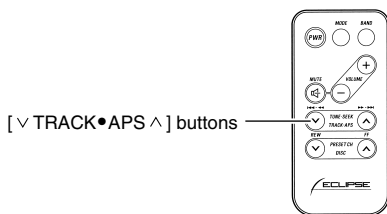

Advancing to the next track or returning to the beginning of the track being played

1 Press the [√ TRACK•APS ^] button.

[^] button: Skips to the next track.

[√] button: Returns to the beginning of the track being played. (Press repeatedly to move to previous tracks.)



Hold the [^] button down to fast forward, or the [√] button to rewind through the track being played.

Replacing the battery



To prevent accidents, store batteries out of the reach of children. If a child has swallowed one, consult a doctor immediately.

Use one CR2025 battery.

- 1** On the back of the remote control, while pressing the locking knob on the battery slot cover toward your right, pull out the battery carrier with your fingernail.

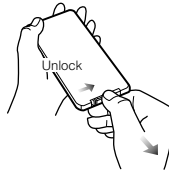

- 2** Remove the old battery, then place the new one in the carrier with the (+) mark facing up.

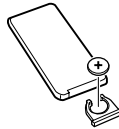

- 3** Push in the carrier until it snaps into place.

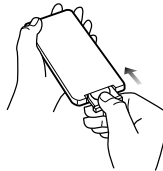

Be extremely careful not to swallow the battery.

How to use an optional NOB remote control

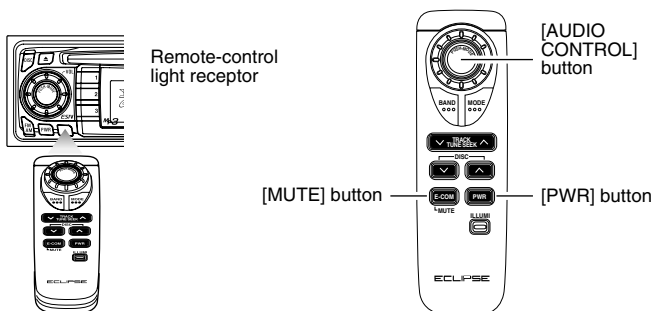

Turning the power on/off

When the power is turned on, the state used when the power was turned off such as CD and tuner playing is restored.

- 1 Press the [PWR] button.

The power turns on or off each time the button is pressed.



When the main unit is shut down, the remote control will not work.

Adjusting the audio volume

- 1 Press the [AUDIO CONTROL] button, and turn it to the left or right.

Each press of the button will switch the audio control modes.

Turn to the right: Increases the volume.

Turn to the left: Decreases the volume.

Cutting the volume instantly (muting)

Press the [MUTE] button to cut the volume or restore it instantly.

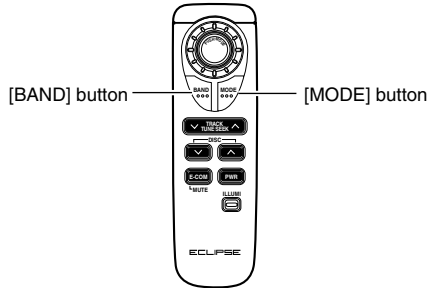

Switching playback modes

- 1 Press the [MODE] button.

Press the button to switch modes in the following sequence:

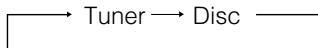

How to play the tuner

Select the tuner mode first.

Selecting the FM/AM band

- 1 Press the [BAND] button.

Each press will switch tuner modes from FM1 → FM2 → FM3 → AM.

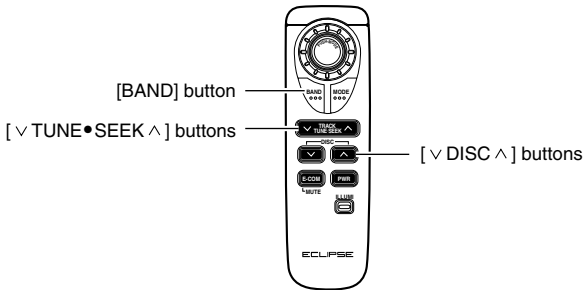

Selecting a station (manually or automatically)

A short tap of the button will allow manual station tuning. Pressing for more than one second will start automatic tuning.

1 Press the [∨ TUNE•SEEK ∧] button.

[∧] button: Tunes to higher frequency stations.

[∨] button: Tunes to lower frequency stations.

Selecting preset stations

A total of six stations may be selected (preset tuning) out of those already set in memory through the main unit. (Refer to “Manually setting stations into memory,” page 40.)

1 Press the [∨ DISC ∧] button.

[∧] button: Selects the next higher number preset button.

[∨] button: Selects the next lower number preset button.

How to play CDs

Select the disc mode first.

Switching disc mode

1 Press the [BAND] button.

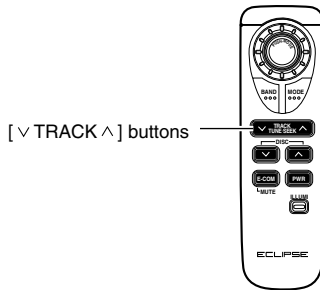

Advancing to the next track or returning to the beginning of the track being played

1 Press the [∨ TRACK ^] button.

[^] button: Skips to the next track.

[∨] button: Returns to the beginning of the track being played. (Press repeatedly to move to previous tracks.)



Hold the [^] button down to fast forward, or the [∨] button to rewind through the track being played.

Replacing the battery



To prevent accidents, store batteries out of the reach of children. If a child has swallowed one, consult a doctor immediately.

Use two AA-size batteries.

- 1** Remove the back cover of the remote control unit by gently pressing and sliding it in the direction indicated by the arrow.

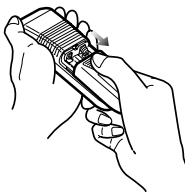

- 2** Install the two batteries provided into the compartment as illustrated inside the compartment.

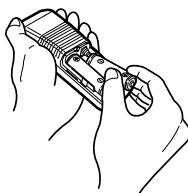

- 3** Return the back cover into place by sliding it in the direction indicated by the arrow.

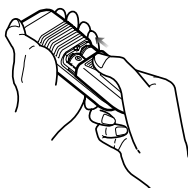



- Be extremely careful not to swallow the battery.
- The battery life is approximately one year. If the remote control unit does not operate correctly or if the button lamp gets dim, replace the batteries.
- Be sure to orient the batteries correctly so that the positive and negative poles match the diagram.
- Do not use one new battery and one old one; use two new batteries.
- Use only two of the same kind of battery.
- If any liquid is seen leaking from the batteries, remove both batteries and dispose of them properly. Thoroughly clean the battery compartment with a dry cloth. Then install new batteries.

If you have a question:

If you have a question:

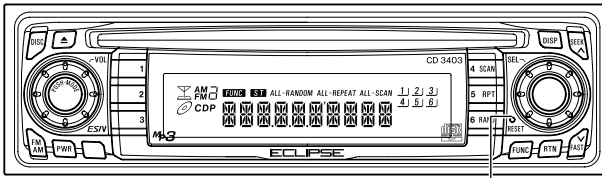

[RESET] button

First check the items mentioned below before attempting to troubleshoot problems.





Caution

If a problem occurs, for instance when the unit does not respond to any button presses, or the display doesn't work correctly, press the [RESET] button using a sharp tool.

Pressing the [RESET] button will delete all the entries from memory. The settings will return to those made at the factory prior to shipment.

Displayed information (for troubleshooting)

The information listed in the chart below is displayed to show the status of the CD player. Refer to the chart for the appropriate action.

Information Code Table	When "INFO  flashes on the indicator
	 Nos.3,5 are displayed.
Information Contents	Explanation and remedial action to take
3 DISCS ARE DIRTY OR DAMAGED	The loaded disc is dirty or upside down. Check it for proper orientation and verify it is clean.
5 CD PLAYER FAILS MECHANICALLY	<ul style="list-style-type: none"> •The CD player is inoperative for some reason. Go through the magazine removal procedure. •If a magazine fails to eject, have your dealer fix the problem.

Mode	Problem	Causes	Remedial action to take	Refer to page
Common to all	Dead or weak sound	Is the volume control up sufficiently?	Turn up the volume control.	22
		Is the fader or balance control set far to one side?	Readjust the fader and balance controls to more normal positions.	23
		Other probable causes include broken audio-signal wiring or a faulty speaker.	Have your dealer check the problem.	—
	Power does not turn on.	Are too many electrical items installed, causing a lack of power?	Have your dealer check the problem.	—
		Other probable causes include a run-down car battery, broken power or interconnection wiring.	Have your dealer check the problem.	—
	Frequencies or titles set in memory are deleted.	Has the car battery been disconnected for repair or checked out?	Reenter them into memory.	39, 40
		Are too many electrical items installed and causing lack of available power?	Have your dealer check the problem.	—
		Other probable causes include run-down car battery, broken power or interconnection wiring.	Have your dealer check the problem.	—
	No guide tone sounds.	Is the guide tone disabled?	Enable the guide tone.	25
	The remote control does not work.	Is the battery low?	Replace battery.	49, 54
		Is the battery installed in reverse polarity?	Reinstall the battery in the correct polarity.	49, 54
		Is direct sunlight hitting the remote control light receptor?	Use the remote control close to the receptor.	—
		Other probable causes include a malfunctioning remote control.	Have your dealer check the problem.	—

Mode	Problem	Causes	Remedial action to take	Refer to page
CD	The disc cannot be inserted. The disc is ejected as soon as it is inserted. Or, the disc cannot be ejected. The disc cannot be changed.	Is an extra label or seal applied to the disc?	Do not apply labels or seals to the disc.	11
		Are there rough edges, deformations or damaged areas on the disc?	Try inserting another disc. Removed any burrs. Do not use a deformed or damaged disc.	12
	Sound skips around. Sound is intermittent. Sound is bad in quality.	Is the disc damaged? (scratched, warped, etc.)	Try another disc. Do not play a damaged disc.	11
		Is the disc clean?	Clean the disc.	13
		Is the player mounted at a proper angle? Is the player mounted loosely?	Have your dealer check it out.	—
		Are you driving over a rough surface?	Avoid playback while driving over rough surfaces.	10
The disc cannot be ejected.	If unknown	Press the [DISC] button a bit longer (forced Eject).	—	

Mode	Problem	Causes	Remedial action to take	Refer to page
Tuner	Receives no stations, or receives static noise.	Is the antenna retracted?	Extend the antenna.	—
		Is the tuner correctly tuned to a station?	Tune to a station.	38
		Are you driving outside the service area of your preset stations?	Tune to a local station. (Please note, there may be no local stations servicing the area where you are currently driving.)	38
		Are you operating other equipment with a computer, or a mobile phone, in your vehicle at the same time as your receiver?	Avoid operating such equipment while using the receiver.	—
		Other problems may include a loose or disconnected antenna cable, a bad antenna cable or a bad	Have your authorized Eclipse retailer check the problem.	—

Specifications

<GENERAL>

Power Supply	14.4V DC (11-16V)
Current Drain	3A MAX
Dimensions (W x H x D)	
In-Dash Unit	7" x 2" x 6-1/8" (178 x 50 x 155mm)
Mass (weight)	Approx. 1.4kg

<FM TUNER>

Frequency Range	87.75~107.9MHz (200kHz step)
Usable Sensitivity	13dBf
Frequency Response	30~15,000Hz, ± 3 dB
Stereo Separation	38dB

<AM TUNER>

Frequency Range	530~1,710kHz (10kHz step)
Usable Sensitivity	20 μ V

<CD SECTION>

Frequency Response	20~20,000Hz, ± 3 dB
Wow & Flutter	Below measurable limits
Stereo Separation	76dB
S/N Ratio (A-weighted)	90dB
Dynamic Range	89dB
Total Harmonic Distortion	0.02%

<AUDIO AMPLIFIER>

Power Output	13W x 4 (20~20,000Hz, 0.8% THD, 4 Ω) Max 40W x 4
Output Level/Impedance	2.7V (0dB) /330 Ω line-out impedance
Tone Action	Bass : ± 10 dB at 100Hz Treble : ± 10 dB at 10kHz
Loudness	+10dB at 100Hz/+6.0dB at 10kHz

Before installation

● Note ●

Be sure to disconnect the battery negative terminal before installing the receiver.

Components

No.	Item	Q'ty
1	Main unit	1
2	Mounting sleeve	1
3	Side bracket	2
4	Rear bracket	1
5	Bezel	1
6	Bushing	1
7	Self-tapping screw (6 x 16 mm)	2
8	Stud bolt	1
9	Flat head screw (5 x 8 mm)	4
10	Hex-head bolt (5 x 20 mm)	2
11	Hex nut (5 mm)	2
12	Interconnecting cable	1

Installation angle

In order to maintain proper functioning, install the unit within an angle of 30 degrees from horizontal (standard). If this is not done, sound skipping or ejection of the CD may occur.

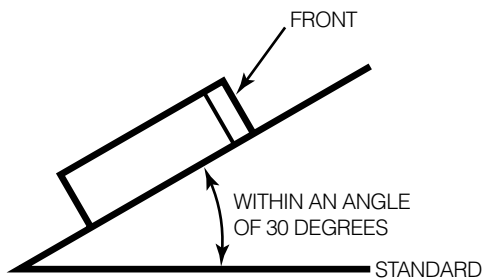

Mounting instruction

Mounting the main unit

- 1** Insert the mounting sleeve into the opening in the vehicle console.
- 2** Use a screwdriver or the like to bend the tabs in the mounting sleeve to secure the mounting sleeve.

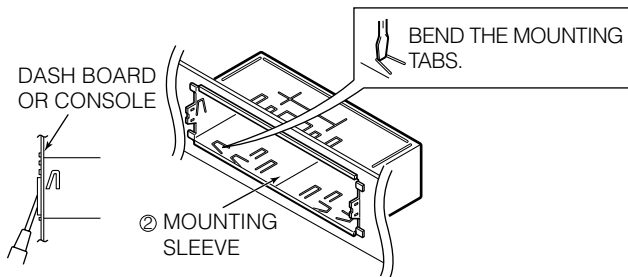

- 3** Attach the side brackets to the main unit using flathead screws.

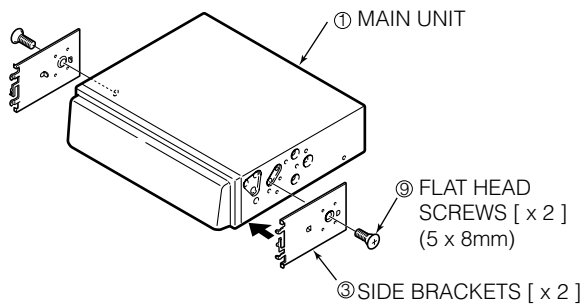

- 4** Mount the stud bolt to the main unit.
- 5** Insert the main unit into the mounting sleeve until it locks in place.
- 6** Fasten the rear of the main unit using either method [A] or [B].

Select method [A] or [B] to suit the interior configuration of the vehicle.

- 7** Install the bezel on the main unit.

[A]

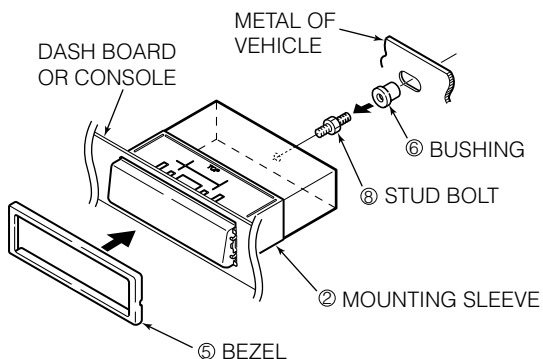

[B]

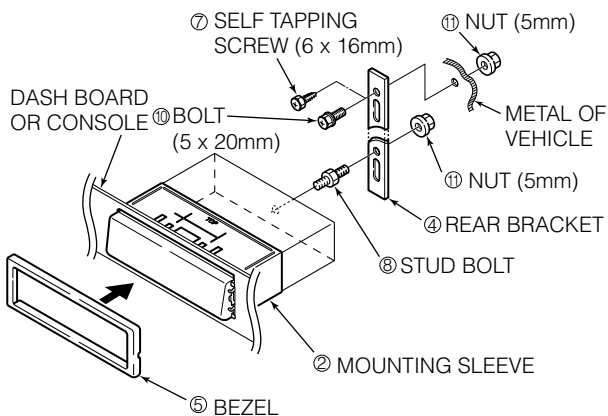

● **Note** ●

To prevent unconnected leads from shorting out, insulate them by wrapping their tips with electrical tape. Similarly, insulate the ends of connected leads.

If an external amplifier is to be connected to the receiver, be sure to ground its outside housing to the vehicle body (a metal part).

Names of lead wires and destinations (refer to Page 67)

No.	Name	Wire color	Destination
1	ACC	Red	Connect where the power comes on when the ignition is in the ACC position.
2	B+	Yellow	Connect where the power is constantly available, regardless of the ignition switch's position.
3	Ground	Black	Connect where good body grounding is available.
4	Antenna power supply	Blue	Connect to the automatic-antenna control terminal of the vehicle.
5	Lamp power supply	Orange/White	Connect to where power comes on when the headlights are turned on.
6	Control power supply	Blue/White	Connect to the control terminal for the external amplifier, etc.
7 & 8	Line-out terminals		Connect to the RCA input connectors of an external amplifier.
9	Speaker terminals		Connect them to their respective speakers.
10	Cellular phone mute	Pink	Connect to the ground output terminal on a mobile phone.

System

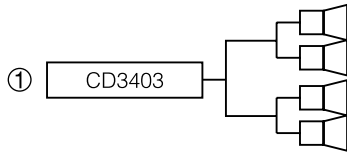

Note:
Adjust the external amplifier's input level.

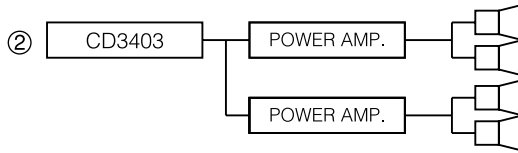

1) CD3403 Receiver, used alone

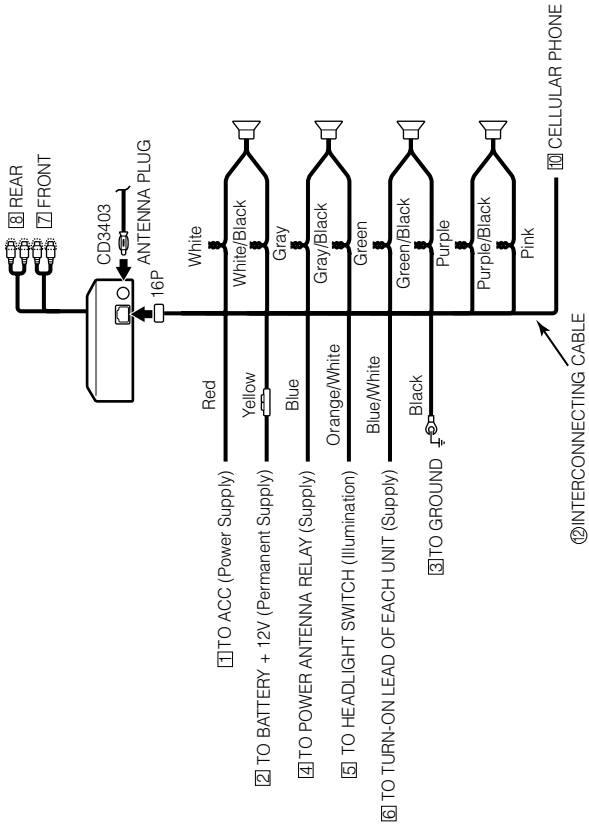

2) CD3403 + Power Amplifier

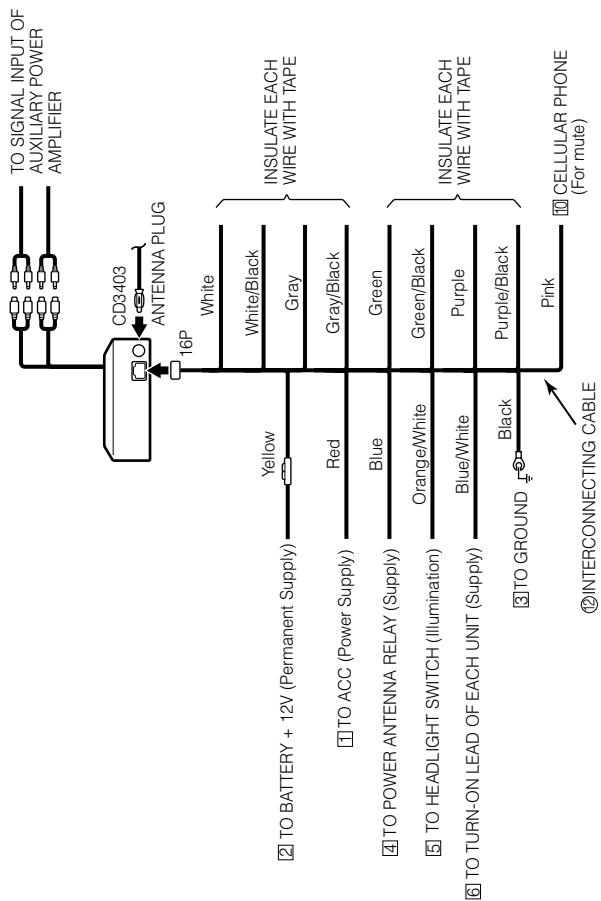

IMPORTANT

**RECORD YOUR “KEY CD”
HERE...**

**STORE YOUR “KEY CD”
ALONG WITH YOUR
OWNER’S MANUAL IN
YOUR SOCK DRAWER.**



This device complies with part 15 of the FCC Rules. Operation is subject to the condition that this device does not cause harmful interference.

CUSTOMER NOTICE

Please retain this booklet and write in the serial number of your CD3403 for identification. The serial number is labeled or stamped on the chassis.

Serial No. _____



DIVISION OF FUJITSU TEN CORP. OF AMERICA
19600 SOUTH VERMONT AVENUE, TORRANCE, CA 90502
(310) 327-2151

090001-1439A700
0303 (Y.O)

Free Manuals Download Website

<http://myh66.com>

<http://usermanuals.us>

<http://www.somanuals.com>

<http://www.4manuals.cc>

<http://www.manual-lib.com>

<http://www.404manual.com>

<http://www.luxmanual.com>

<http://aubethermostatmanual.com>

Golf course search by state

<http://golfingnear.com>

Email search by domain

<http://emailbydomain.com>

Auto manuals search

<http://auto.somanuals.com>

TV manuals search

<http://tv.somanuals.com>