

# ECLIPSE<sup>®</sup>

by FUJITSU TEN

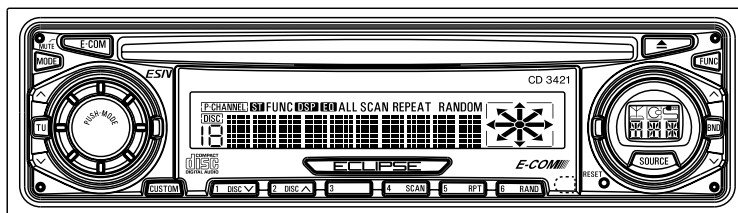

MODEL **CD3421**

**ESN E3 High-Power CD Receiver  
with CDC/E-COM Control**

## **OWNER'S MANUAL**

We appreciate your purchase of this receiver.  
Please read through this manual for correct operation.  
We suggest that after reading it you keep this manual  
in a safe place for future reference.

# ***For your safety in using the CD3421***

Warnings and caution signs, illustrated below, are posted throughout this manual as well as on the CD3421. They show safe and correct ways to handle the product so as to prevent personal injury to you and others and avoid damage to property.

Before reading through the manual, take time to read through and learn the important information listed in this section.



## **Warning**

This sign indicates a situation in which incorrect handling through disregard of a sign might result in death or serious personal injury.



## **Caution**

This sign indicates a situation in which incorrect handling through disregard of a sign might result in personal injury or may result solely in damage to property.



## **Warning**

---

- Do not modify this system for use other than that specified herein. Also, do not deviate from the installation procedures described herein; Eclipse will not be held liable for damages including, but not limited to serious injury, death or property damage resulting from installations that enable unintended operation.
- This unit is intended for operation in DC 12-volt, negative-grounded vehicles *only*. Never use it in 24-volt vehicles such as heavy trucks or diesel cars with cold-region specifications.
- Do not change CDs while driving. Doing so may result in an accident.

---

 **Warning**

---

- Do not place the vinyl storage bag over a person. It may cause a serious accident or death by suffocation.
- Do not adjust the controls while driving the car. To adjust the controls, stop the car in a safe location.
- To prevent accidents, store batteries for the remote control out of the reach of small children. In case a child swallows a battery, consult a physician immediately.
- Do not disassemble or rebuild this product. Doing so may cause an accident, fire or electrical shock.
- When it is necessary to replace the fuse, always use a fuse of the correct rating (number of amperes). Use of fuses with higher amperage ratings may cause a fire.
- Do not operate the product in a malfunctioning condition, for instance, when the audio does not play. Doing so may result in an accident, fire or electrical shock.
- If an abnormal situation occurs, such as foreign matter entering or liquid splashing on the product, or smoke or a strange odor emitting from the unit, shut off the product immediately and consult the dealer from whom you purchased it. Continued operation may cause an accident, fire or electrical shock.
- Do not install this product in locations where it may obstruct the driver's view, or where it may endanger passengers in the vehicle. Otherwise, an accident or injury may result.
- Do not install this product in locations where it may interfere with the operation of the steering wheel, shift lever, brake pedal, etc. Otherwise, an accident or injury may result.
- When installing this product, never use existing nuts or bolts that secure parts of the fuel tank, or the steering or braking systems. Otherwise improper steering or braking or a fire may result.

---

 **Warning**

---

- To prevent a short circuit from occurring, disconnect the battery's negative terminal before installing this product. Otherwise, an electric shock or injury may result.
- When using an existing nut and/or bolt from the vehicle to ground this product, do not use any that secure parts of the steering or braking systems. Otherwise, an accident may result.
- Bundle cables and harnesses with electrical tape or wire ties to prevent them from interfering with moving parts. If they should entangle the steering wheel, shift lever or brake pedal, an accident may result.
- Never supply power to another electrical appliance by splicing or tapping into this product's power lead(wire). Otherwise, the current capacity of the wire will be exceeded, resulting in a fire or electric shock.
- Never attempt to disassemble or modify the product. Otherwise, an accident, fire or electric shock may result.
- When installing the product into a vehicle with a passenger side air bag, do not secure it to the air bag's cover or in places where it may impede air bag deployment. Otherwise, proper air bag operation may not be ensured in the event of an accident, causing injury or death.
- When making holes using a drill or similar tool, be sure to wear protective eyewear. Otherwise, an injury such as loss of eyesight may result.
- Exposed wires must be insulated with electrical tape. Otherwise, a short circuit, fire, or electric shock may result.



## Caution

---

- Play the audio at a moderate volume level that permits you to hear sounds from outside the car. Driving without being able to hear outside sounds may result in an accident.
- Keep foreign objects out of the disc slot. They may cause fire or electrical shock. Another possibility is that discs may be damaged or become stuck.
- Do not stick your fingers or hands into the disc slot. Doing so may cause personal injury.
- This product must be operated only as on-board equipment, or it may cause electrical shock or injury.
- Do not play distorted sounds for long periods of time; the speakers may overheat and cause a fire.
- This product uses an invisible laser light. In case a problem develops, be sure to consult the dealer from whom you purchased the product. Do not disassemble or rebuild the unit; rebuilding it may expose you and others to a dangerous laser emission (which would damage eyesight) or cause an accident.
- Never use batteries other than those specified. Do not mix new and old cells. Doing so may cause a fire or personal injury due to a battery explosion or chemical leaks.
- Pay attention to the (+) and (-) polarity of the battery when installing it in the product. Incorrect installation may cause personal injury or product damage due to a battery explosion or chemical leakage.
- For best results, this product should be installed by a professional installer.  
Contact the dealer whom you purchased the product for an appointment.
- When installing this product, be sure to use the supplied mounting hardware. If parts other than those supplied are used, the unit may be damaged internally, or may not be held in place securely and become dislodged.



## Caution

---

- Avoid installing this product in places where it may get wet, such as near windows, or in places that are moist or dusty. Presence of liquid, moisture or dust inside this product can cause short circuiting, resulting in smoke or fire.
- Do not install this product in locations where it cannot be fastened securely, such as places subject to frequent vibration. Otherwise, it may become dislodged and cause an accident or injury.
- Do not block this product's vent or heat sink. If either is blocked, excessive heat build-up may occur and cause a fire.
- If this product is not connected properly, a short circuit, fire or accident may occur.
- When routing cables, use care so that they do not contact sharp metal parts such as brackets or screw tips. Otherwise, a short circuit, electric shock, fire or accident may result.
- Do not obstruct the vent on this product. If blocked, excessive heat build-up may occur and cause a fire.

# Table of Contents

<b><i>Operating Precautions</i></b> .....	<b>10</b>
Notes on Operation .....	10
About compact discs .....	12
About cleaning a CD .....	14
<b><i>Names of controls and parts</i></b> .....	<b>15</b>
<b><i>ESN (Key CD) Security Operating Procedure</i></b> .....	<b>16</b>
How to program the Key CD .....	16
How to cancel the Key CD .....	17
How to change the Key CD .....	18
How to resume normal operation (ESN security lock out) .....	19
What happens if an incorrect CD is inserted? .....	20
How to turn the Security indicator on/off .....	21
How to read the Electrical Serial Number .....	21
<b><i>Basic operation</i></b> .....	<b>22</b>
Turning the power on and off .....	22
Listening to a CD .....	22
Listening to the tuner .....	23
Adjusting audio volume .....	24
Displaying the clock .....	24
Others .....	25
<b><i>How to operate the CD player</i></b> .....	<b>29</b>
Listening to CDs .....	29
Advancing to the next track or returning to the beginning of the track being played .....	30
Playing the beginning of tracks (SCAN) .....	30
Repeating the same track (REPEAT) .....	31
Playing tracks in random order (RANDOM) .....	31
Ejecting the disc .....	31
<b><i>How to operate the tuner</i></b> .....	<b>32</b>
Tuning to a station .....	32

Entering stations into memory automatically (The automatic preset mode: ASM) .....	33
Manually setting stations into memory .....	34
Preset station scan .....	35
FM reception characteristics .....	36
<b><i>How to use an optional Card remote control .....</i></b>	<b>39</b>
Precautions in use of the remote control .....	39
Cleaning the remote control .....	39
Turning the power on/off .....	40
Adjusting the audio volume .....	40
Switching playback modes .....	40
How to play the tuner .....	41
How to play CDs .....	42
Switching the remote control settings .....	43
Replacing the battery .....	44
<b><i>How to use an optional NOB remote control .....</i></b>	<b>45</b>
Turning the power on/off .....	45
Adjusting the audio volume .....	45
Switching playback modes .....	46
How to play the tuner .....	46
How to play CDs .....	47
Illuminating the NOB remote control .....	48
Enabling the optional E-COM feature .....	48
Switching the remote control settings .....	49
Replacing the battery .....	50
<b><i>How to operate the receiver with an optional CD changer connected .....</i></b>	<b>52</b>
Basic operation .....	52
<b><i>If you have a question: .....</i></b>	<b>55</b>
Displaying information (for troubleshooting) .....	56
<b><i>Specifications .....</i></b>	<b>59</b>
<b><i>Before installation .....</i></b>	<b>61</b>
Components .....	61
Setting the system-selector switch .....	61



<b><i>Mounting Instruction</i></b> .....	<b>62</b>
Mounting the main unit.....	62
Names of lead wires and destinations .....	64
System .....	65

## Operating Precautions

<Your CD3421 will perform well over a long period of time through correct handling and care.>

### Notes on Operation

- For your safety, play only at volume levels that allow outside sounds to be heard.

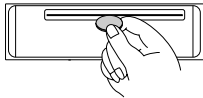

- Use only audio compact discs.  
This player can only play compact discs bearing the logo shown to the left.
- It may not be possible to play back some tracks on CD-Rs.
- It may not be possible to play back CD-Rs with certain characteristics, or CD-Rs which are scratched, dirty, or which have been left inside a vehicle for long periods.
- CDs cannot be played back until all sessions recorded on the CD-R have been closed.
- CD-RW discs cannot be played back.
- Do not insert anything other than a CD into the disc slot.

Do not insert any foreign objects, such as coins or credit cards, into the disc slot. Be especially watchful of children's mischief in this regard.

- Avoid severe mechanical shock.  
When the player is subjected to severe vibration while traveling over a rough surface, playback may be intermittent. When a situation like this occurs, resume playback after returning to a smoother road.



- About dew condensation  
In cold or rainy weather, just as the interior glass surface gets fogged, dew (water condensation) may also settle on the deck. When this occurs, disc playback may become intermittent or impossible. Dehumidify the air in the vehicle for a while before resuming playback.

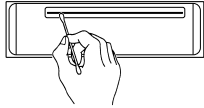

- Cleaning the disc slot  
The disc slot tends to get dusty. Clean it occasionally to prevent accumulated dust from scratching the discs.

## About compact discs

- The signal recorded on a compact disc is read by a laser beam, so nothing touches the disc surface. A scratch on the recorded surface or a badly warped disc may cause deteriorated sound quality or intermittent playback. Observe the following precautions to ensure high quality sound performance:



- Do not leave an ejected disc in the disc slot for very long; the disc may warp. Discs should be stored in their cases and kept away from high temperature and humidity.

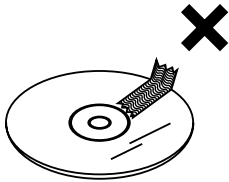

- Do not stick a piece of paper or tape on, nor write on or scratch, either side of a disc .

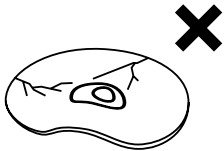

- Discs spin at a high speed inside the deck. Keep cracked or warped discs out of the player to avoid damaging it.

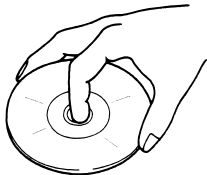

- Avoid touching the recorded surface when handling a disc; handle discs by their edges.

**About brand new CDs**

- You may notice that some brand new discs are rough around the center hole or outside edge. Remove the rough edges with the side of a ballpoint pen, etc. Rough edges may prevent proper loading in the deck. Flakes from the rough edges may also stick to the recorded surface and interfere with playback.

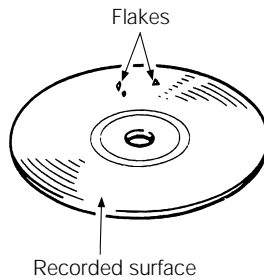
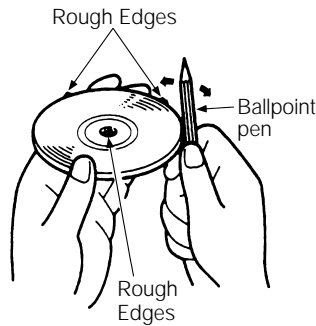

**About CD accessories**

- Do not use accessories (stabilizers, protective seals, laser lens cleaners, etc.) sold for "improving sound performance" or "protecting CDs." The changes in CD thickness or outside dimensions made by these accessories may cause problems in the player.

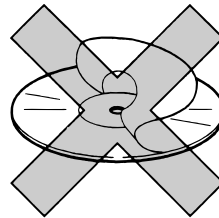

- Please be sure NOT to attach any ring-shape protector (or other accessory) to your discs. Those protectors are commercially available and said to protect disc and to improve sound quality (and antivibration effect), but they can do more harm than good in regular uses. The most common problems are Insert /Eject related problems and "No playback" problems due to the protector that came off in the disc mechanism.

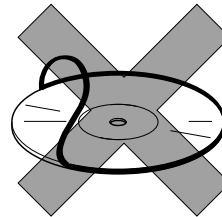

## Operating precautions

### About borrowed CDs

- Do not use a CD with glue or remnants of adhesive tape or labels. They may cause the CD to get stuck inside or damage the deck.

### How to remove CDs

- When removing the ejected disc, pull it straight out along the slot. Pressing downward in the process may scratch the recorded surface of the disc.

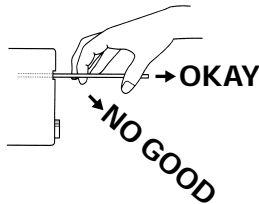

### About irregularly-shaped CDs

- Specially-shaped CDs, like heart-shaped or octagonal CDs, cannot be played. Do not attempt to play them, even with an adapter, since they may damage the player.

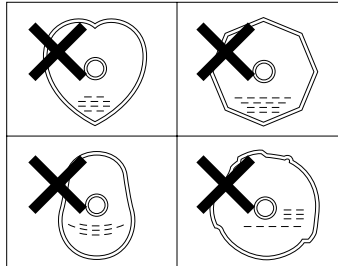

### About cleaning a CD



- Use a commercially available compact disc cleaner to clean a CD, wiping lightly from the center to the edge.

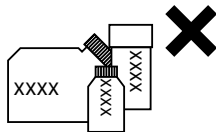

- Do not use benzine, thinner, LP record spray or other cleaners on CDs. They may damage a CD's finish.

# Names of controls and parts

## Front View

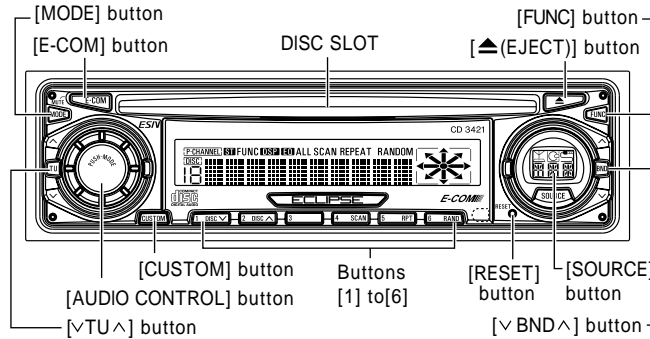

NOTE : Double function button "E-COM" & "MUTE" functions



- Though the words "press" and "tap" are used in the text for the operation of the [∨TU∧] button, and [∨BND∧] button, the button is actually slid in the ^ or ∨ direction.

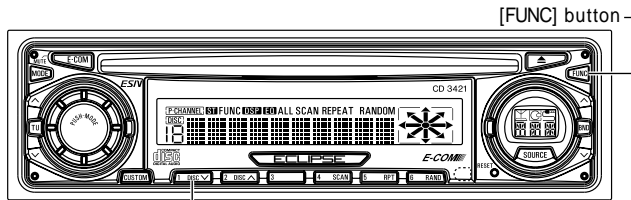

---

## ***ESN (Key CD) security operating procedure***

### **How to program the Key CD**

- 1** . Turn off the main unit power.
- 2** . Press and hold button [1], then the [FUNC] button, and hold both for more than one second.  
A [SEC] message appears, then in two seconds it will change to [DISC].  
The CD3421 is now ready to accept your Key CD in the CD slot.
- 3** . Insert the CD into the slot.  
A [SEC] message appears, the Key CD is ejected.



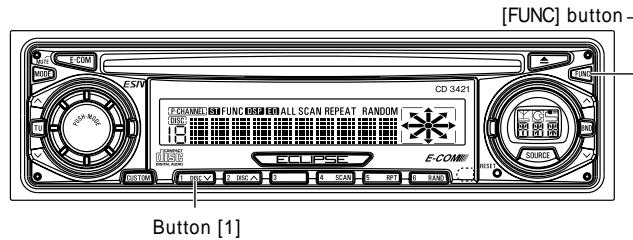

### ATTENTION

- If there is a problem with the inserted CD, an [ERR] message will appear for two seconds and the CD will be ejected. Reinsert the ejected CD.
- If a CD causes the [ERR] message to appear twice in a row, a [CHANGE] message will appear for two seconds. Try another CD.
- The Security indicator will flash whenever the vehicle's ignition is switched off.

## How to cancel the Key CD

- 1** . Turn off the main unit power.
- 2** . Press and hold button [1], then the [FUNC] button, and hold both for more than one second.  
A [SEC] message appears, then in two seconds it will change to [DISC].  
The CD3421 is now ready to accept your Key CD in the CD slot.
- 3** . Insert your Key CD into the slot.  
A [CANCEL] message appears, the Key CD is ejected.  
The Key CD is cancelled.



- This process cancels the protection for the ESN deck.
- If power to the CD3421 is disconnected, then reconnected, a key CD will not need to be inserted in order to return the unit to normal operation.
- Inserting a CD other than the Key CD will not cancel the protection. Instead, the display will show [ERR] for two seconds, then the normal CD playback mode will activate.

## How to change the Key CD

- 1 . First, cancel the existing Key CD.**  
Refer to "How to cancel the Key CD."
- 2 . Next, program a new Key CD.**  
Refer to "How to program the Key CD."

## How to resume normal operation (ESN security lock out)

If power to the CD3421 is disconnected while ESN security is active (a Key CD was programmed), operation is disabled until power is restored and the unit unlocked. Follow this procedure to resume normal operation.

**1** . When the power is turned on after disconnecting the battery power, a [SEC] message will appear for two seconds. Thereafter, the message changes to [DISC] and the CD3421 is ready to accept your Key CD into the slot.

**2** . Insert your Key CD.

If the correct CD is inserted, an [OK] message will appear for two seconds and the CD will begin playing.



- If an incorrect CD is inserted, an [ERR] message will appear for two seconds, after which the CD will be ejected.
- You must use the same CD used for Key CD programming; a duplicate CD may not work properly.

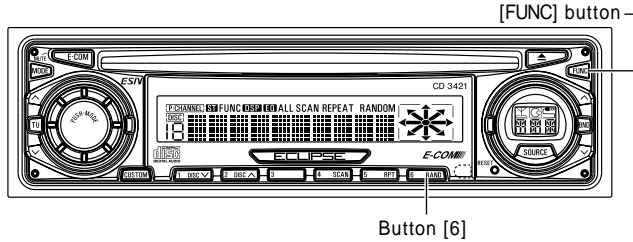

## What happens if an incorrect CD is inserted?

- 1 . An [ERR\_] message will be appear, then change to a flashing [DISC], then the CD will be ejected.  
You will have five uninterrupted attempts to insert the correct CD.
- 2 . After the 5<sup>th</sup> incorrect attempt, the display reads [HELP].
- 3 . If [HELP] appears on the display, press button [6], then the [FUNC] button, and hold them for five seconds .
- 4 . Press the [FUNC] button.  
You will have five more attempts to insert the correct disc.



- Number of errors: Numbers indicated the number of errors that occurred.

### Note

If after 10 tries the correct Key CD is not insereted, the display reads [CALL 800]; *the unit must be returned to Eclipse to be reset*. In this case, please contact your Eclipse dealer for assistance or call Eclipse directly at (800)233-2216

**Your key CD can be easily forgotten. Write the album name in a reminder note (Pg.71).**

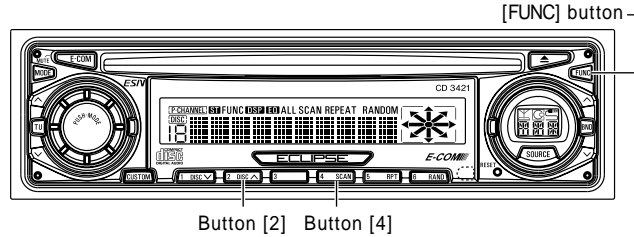

## How to turn the Security indicator on/off

Once ESN security is activated, the indicator flashes whenever the vehicle's ignition is turned off, warning potential thieves that the unit is protected. However, if you do not want this visible deterrent, it may be turned off.

1. With the power is turned off, press button[2], then the [FUNC] button and hold both for more than a second.
2. [INDICATOR flash] or [INDICATOR OFF] appears on the display.

[IND.FLASH] means the security indicator will flash when the vehicle's ignition is off, and [IND. -----] means it will not. Repeat the above steps to reactivate the flash mode.

## How to Read the Electronic Serial Number

1. Turn off the main unit power.
2. Press button [4], then the [FUNC] button, and hold both for more than a second.

[ESN] appears on the display, followed by an eight-digit number; this number is your electronic serial number (ESN). You may use this number to identify your Eclipse CD3421 in the event it is recovered after being stolen.

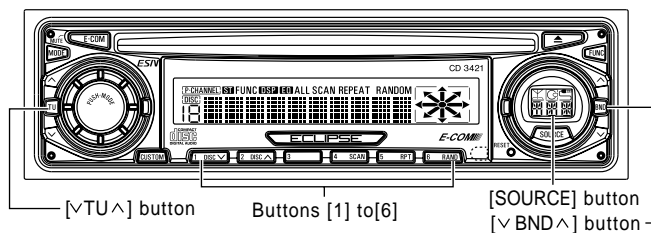

## Basic operation

This section covers basic operating procedures. For additional details, please refer to the sections on specific functions.

### Turning the power on and off

#### 1. Press the [SOURCE] button.

- Less than two seconds : Each tap will switch modes from Tuner  
Disc PWR OFF (Stand by).
- More than two seconds : Off



- If a car is not equipped with an ACC position (for example, a European car), keep the [SOURCE] button depressed for more than two seconds.

### Listening to a CD

#### 1. Insert a CD into the disc slot, label side up. The CD will immediately start playing.



- When a CD is already loaded, pressing the [SOURCE] button repeatedly to switch to the CD mode.

## Listening to the tuner

- 1 . Press the [SOURCE] button repeatedly to switch to the tuner mode.**

This will turn the tuner on.

To turn the tuner off, press the [SOURCE] button either shorter to select another mode or longer to turn the power off.

- 2 . Tap the [ $\vee$  BND  $\wedge$ ] button to switch to the desired FM or AM bands.**

[ $\wedge$ ] button: Switch the FM band

Pressing the button repeatedly switches the FM band in the order of FM1 FM2 FM3.

[ $\vee$ ] button: Switch to the AM band.

- 3 . Turn the [ $\vee$  TU  $\wedge$ ] button to tune to a station.**

A tap on either the [ $\vee$ ] or [ $\wedge$ ] button for less than one second will enable manual station tuning. Hold one button down for more than two seconds to start the automatic station search.

[ $\wedge$ ] button: Starts searching toward higher frequencies.

[ $\vee$ ] button: Starts searching toward lower frequencies.



- If stations have been stored in memory, pressing a button from [1] to [6] will directly select a station. (Refer to the section "Manually setting stations into memory" on page 34.)





3 . Press the [SOURCE] button to switch to the [CLOCK ON] display.

4 . Press the [FUNC] button again.

Refer to the section on “ setting the clock ” to set the time display.

## Others

### **Disabling the guide tone feature (for button operation)**

The receiver is set at the factory to emit a beep tone in response to button operation. The guide tone feature may be disabled in the following procedure:

1. Press the [FUNC] button for more than one second.
2. Press the [∨ BND ∧] button repeatedly until [BEEP ON] display appears on the screen.
3. Press the [SOURCE] button to switch to the [BEEP OFF] display.
4. Press the [FUNC] button again.

### **Contrast adjustment**

Adjust the display contrast to the best level in accordance with the angle of viewing.

- 1 . Press the [FUNC] button for more than one second.
2. Press the [∨ BND ∧] button repeatedly until [CONT] display appears on the screen.
3. Press the [SOURCE] button to change contrast.
4. Press the [FUNC] button again.

## Basic operation

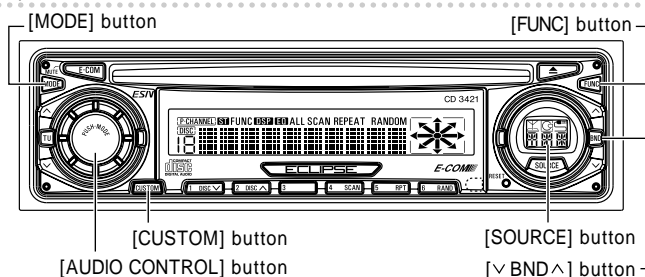

### Setting the clock

This receiver uses the 12-hour, A.M./P.M. display notation.

1. Press the [FUNC] button for more than one second.
2. Press the [CUSTOM] button to switch to the clock adjustment mode.
3. Press the [SOURCE] button to select the hour or minutes to be adjusted.  
The blinking one can be adjusted.
4. Press the [v BND ^] button.  
[^]button : Turns the time forward.  
[v]button : Turns the time back.
5. Press the [CUSTOM] button again to return to the normal mode.



- To set the clock to 0 minutes, 0 seconds (an exact hour), press the [MODE] button.

For example:

At 3:29: Pressing the [MODE] button returns to 3:00.

At 3:30: Pressing the [MODE] button advances to 4:00.

## Switching audio control modes

Various audio control modes may be fine-tuned using this procedure.

1. Press the [AUDIO CONTROL] button for less than one second.

Pressing the button repeatedly will allow you to control adjustments of [BASS] (low frequencies), [TREB] (high frequencies), [FADER] (front-rear speaker balance), [BAL] (left-right speaker balance), and [SUB-W] (subwoofer level).

2. Turn the [AUDIO CONTROL] button to the left or right

It controls levels and adjust the sound to your preference.



- When Tone Control feature is off, adjustment of BASS and TREB will be skipped.

## Enabling the loudness control

The loudness control may be turned on to emphasize low and high frequencies at low volume levels.

Loudness compensates for the apparent weakness of low and high frequencies at low volume by boosting the bass and treble levels.

1. Press the [AUDIO CONTROL] button until the [LOUD ON] display appears on the screen.



- To disable the loudness feature, repeat the above procedure to display the [LOUD OFF] indication.

## Basic operation

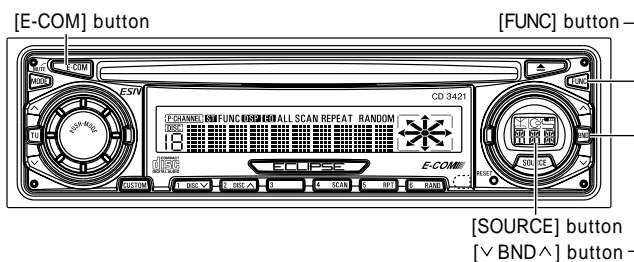

### Switching Non-Fader modes

- 1 . Press the [FUNC] button for more than one second.
- 2 . Press the [ $\vee$  BND  $\wedge$ ] button repeatedly until the [PHASE NORM] display appears on the screen.
- 3 . Press the [SOURCE] button.  
Each press of the button switch modes between the Normal and Reverse.
- 4 . Press the [FUNC] button again.  
Pressing the button will cancel Function mode.

### Disabling the Tone Control feature

- 1 . Press the [FUNC] button for more than one second.
- 2 . Press the [ $\vee$  BND  $\wedge$ ] button repeatedly until the [TONE ON] display appears on the screen.
- 3 . Press the [SOURCE] button.  
Pressing the button will switch the tone control feature on or off.
- 4 . Press the [FUNC] button again.

### Enabling E-COM feature

- 1 . Press the [E-COM] button for one second.  
Pressing the button will switch the E-COM feature on or off.

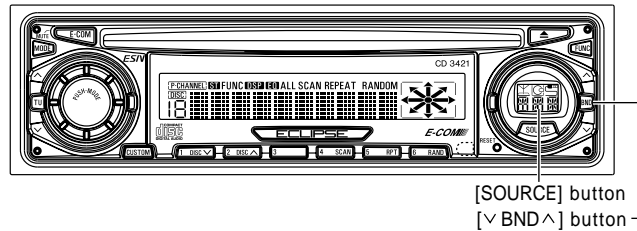

## ***How to operate the CD player***

First press the [SOURCE] button to switch to the disc mode. It is assumed here that a CD has already been loaded into the unit.

### **Listening to CDs**

#### **1 . Press the [SOURCE] button.**

This turns on the disc mode and starts CD play.

If an external CD changer is connected, each additional tap of the [v BND ^] button will switch modes from CD changer 1 → CD changer 2 → CD player.

A changer or player with no discs loaded will be skipped.

#### ***Caution***

- Playback may be intermittent when there is a scratch on a CD or when the recorded side is dirty.
- Only two external CD changers may be connected.

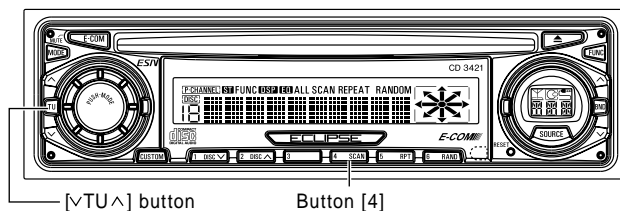

## Advancing to the next track or returning to the beginning of the track being played

1. Press the [v TU ^] button.  
[^] button: Advances to the next track.  
[v] button: Returns to the beginning of the track being played.



- Pressing and holding the [^] button will fast-forward through a track, while pressing the [v] button will fast-reverse.

## Playing the beginning of tracks (SCAN)

1. Press button [4 (SCAN)].  
Tapping the button causes the player to move up to the next track and play it for 10 seconds, then move up to the next track and play it for 10 seconds, and so on until the button is tapped again.



- To continue playing a desired track, press the button again to stop scanning.

## How to operate the CD player

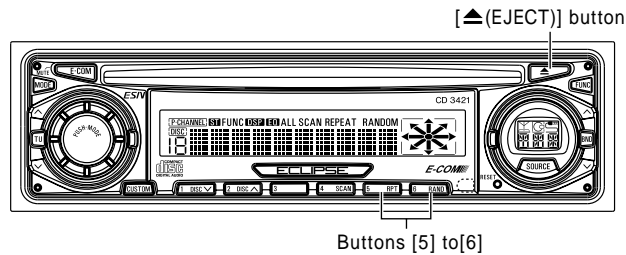

### Repeating the same track (REPEAT)

- 1 . Press button [5 (RPT)] to repeat the track being played.  
To cancel, press button [5] again.

### Playing tracks in random order (RANDOM)

- 1 . Press button [6 (RAND)] to play the tracks in random order.  
To cancel, press button [6] again.



- Occasionally the same track happens to be played (selected) two or more times in a row; this is normal operation and is no sign of a problem.

### Ejecting the disc

- 1 . Press the [ ▲ ( EJECT ) ] button.

## How to operate the tuner

---

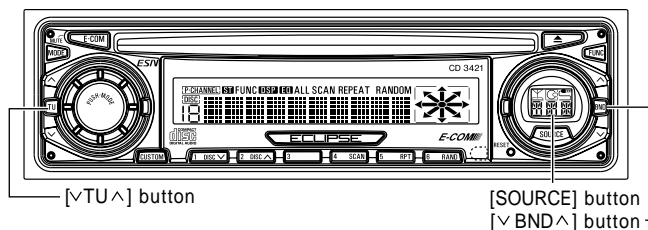

---

## *How to operate the tuner*

First, press the [SOURCE] button to start tuner operation. There are automatic and manual methods for setting stations in memory. The receiver will accept up to 24 stations in memory: six in AM and 18 in FM (6 each for FM1, FM2 and FM3.)

### Tuning to a station

- 1. Tap the [v BND ^] button to switch to the desired FM or AM bands.**
  - [^] button: Switch the FM band  
Pressing the button repeatedly switches the FM band in the order of FM1 FM2 FM3.
  - [v] button: Switch to the AM band
- 2. Press the [v TU ^] button to tune to a station.**
  - Tap the [v] or [^] button for less than one second to tune to a station manually.
  - To start searching for a station automatically, hold the button down for more than one second.
  - [^] button: Tunes to higher frequencies.
  - [v] button: Tunes to lower frequencies



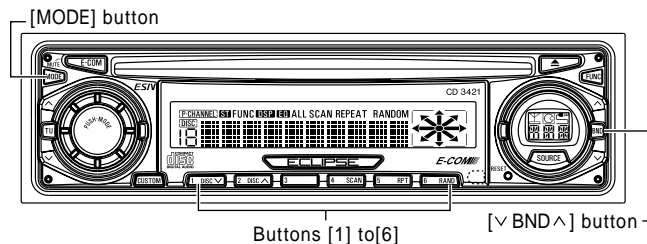

### ATTENTION

- At times, it may be difficult to maintain optimum reception because the antenna affixed to your vehicle is in motion constantly (relative to the broadcast antenna), encountering continuous variation in the received radio signals' strength. Other factors affecting reception include interference from natural obstacles, sign posts, etc.

## Entering stations into memory automatically (The automatic preset mode: ASM)

- 1 . Tap the [∇ BND ^] button to switch to the desired FM or AM bands.**  
[ ^ ] button: Switch the FM band.  
Pressing the button repeatedly switches the FM band in the order of FM1 FM2 FM3.  
[ ∇ ] button: Switch to the AM band.
- 2 . Press the [MODE] button for more than two seconds until a beep is heard.**  
The automatic preset mode starts.  
The [ASM] indicator on the screen flashes, and stations are automatically entered in memory under buttons [1] to [6].  
These buttons are called preset buttons.

## How to operate the tuner

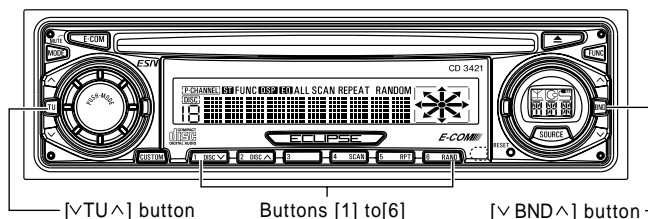

### ATTENTION

- Press any numbered button to select the station whose frequency is indicated right above the button.
- When a new station is set in memory, the station previously set in memory will be deleted.
- If the number of receivable stations fewer than six, the stations set in the rest of the preset buttons will be retained.

## Manually setting stations into memory

This section covers the setting of stations in memory under the numbered buttons.

- 1** . Press the [V BND ^] button to switch between FM and AM.
- 2** . Use the [V TU ^] button to tune to the station to be entered in memory.
- 3** . Select any button, from [1] to [6], and press it for more than two seconds.  
The tuned station is now memorized and set in the button selected. Repeat the procedure to set additional manually tuned stations in memory, in turn, for buttons [1] to [6]. These buttons are called the preset buttons.

### Caution

- If the vehicle's battery is disconnected (for repairs to the vehicle or for removing the receiver), all stations in memory will be lost. In such a case, set stations in memory again.

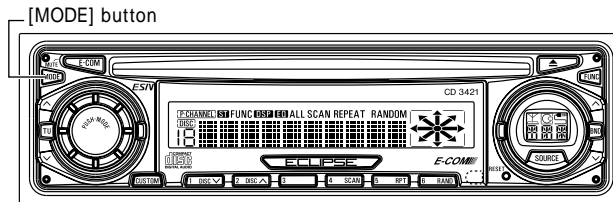

## Preset station scan

This function enables reception of all the stations in the numbered preset buttons for five seconds each.

- 1 . Press the [MODE] button.**  
[P SCAN] will appear at the top of the display, and stations stored under preset buttons [1] through [6] will be played for five seconds each.
- 2 . To stop the scan mode at a desired station, press the [MODE] button again.**  
The receiver will stay tuned to the desired station.

## FM reception characteristics

In general, FM has much better tonal quality than AM. However, FM and FM stereo reception encounter several characteristic problems not encountered with AM. FM is more difficult to receive than AM in a moving vehicle. The following are explanatory notes on what to expect from FM reception and on how to get satisfactory performance.

### 1 . FM RECEPTION DIFFERS FROM AM

A characteristic of transmitted signals is that lower frequencies travel further. FM frequencies are much higher than AM's (similar to a ray of light): they won't bend but they will reflect. Often, they will be interrupted by tall buildings, mountains, etc., taking direct and indirect paths to your vehicle's antenna. The distance at which FM stations can be received satisfactorily is usually not nearly as far as that which AM stations can be received.

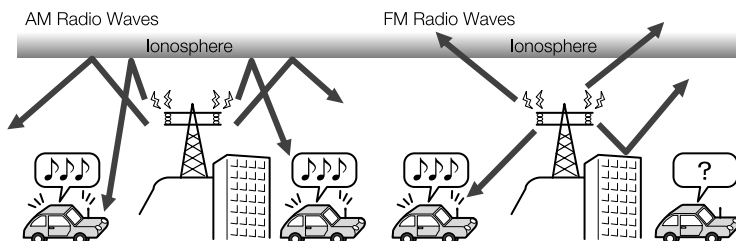

### 2 . FADING OUT

In weak signal or "fringe" reception areas, FM stations may fade out completely, or fade in and out. When driving in weak signal areas, such as near hills, through valleys or tunnels, among tall buildings, etc., you may encounter unusual noise interference. THIS IS NOT A TUNER PROBLEM. In this case, you can only wait until you are in a better reception area, tune to a stronger station, or reduce the treble level.

### 3 . RECEPTION AREA OF FM BROADCASTS

A home receiver can catch weak FM stereo signals through the use of a tall, directional or ultra-sensitive antenna. In a moving vehicle, the area for good reception is limited because of varying conditions encountered while driving, including the types and heights of broadcast antenna structures, signal strength, engine noise, etc. For best reception with manual antenna, extend the antenna mast as far as possible.

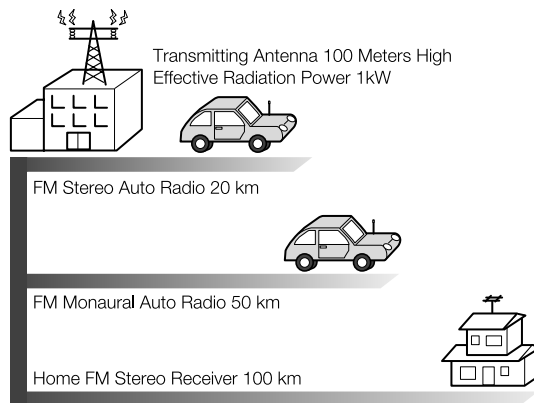

Reception quality varies depending on the power of the FM station, natural and artificial barriers, weather conditions, etc.

## 4 . MULTIPATH

The reflection characteristics of FM waves cause another problem called multipath—FM wave signals reflecting off of buildings, mountains, etc. When the antenna receives direct and reflected waves at the same time, distortion of sound in the treble range often occurs, such as static or a harsh-sounding voices. THIS IS NOT A TUNER PROBLEM. Only moving to another area with a clearer signal path can remedy the situation.

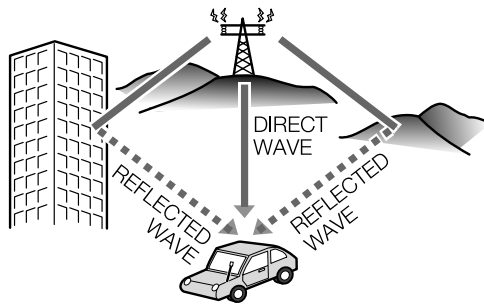

## ***How to use an optional Card remote control***

### **Precautions in use of the remote control**

- Be careful when handling the control, especially because it is small and light. Dropping or striking it hard may damage it, wear out the battery or cause a malfunction.
- Keep the remote control free of moisture, dust and water. Do not subject it to shock.
- Do not place the remote control unit where it will get hot, such as on the dashboard or near a heater vent. Allowing the remote control unit to overheat may warp its case or cause other problems.
- Do not operate the remote control unit while driving because doing so could cause an accident.
- When using the remote control, point it directly at the remote control light receptor.
- The light receptor may not operate correctly if it is exposed to bright light such as direct sunlight.
- Be sure to press the [SOURCE] button on the main unit for more than two seconds to shut it down before leaving the car, or the car battery may be run down. When the main unit is shut down, the remote control will not work.
- Remove the batteries from the remote control unit whenever it is not to be used for a long time.

### **Cleaning the remote control**

- Use a dry cloth to keep the unit clean, If the remote control unit gets extremely dirty, clean it with a cloth moistened in dilute liquid detergent. Do not use alcohol or thinner; these compounds may damage the finish.
- In no event should benzine or thinner be used. These substances will damage the case or finish.

## How to use an Optional Card remote control

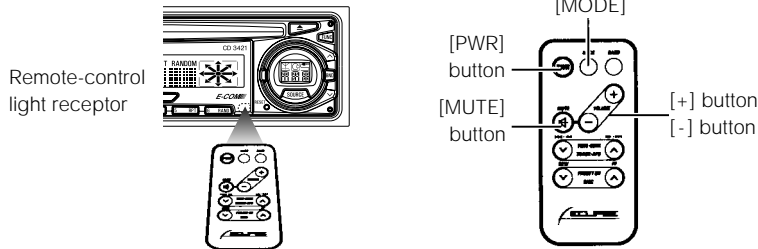

## Turning the power on/off

1. Press the [PWR] button.  
The power turns on or off each time the button is pressed.



- When the main unit is shut down, the remote control will not work.

## Adjusting the audio volume

1. Press the [+ ] or [- ] button.  
[+ ] button: Increases the volume.  
[- ] button: Decreases the volume.

### Cutting the volume instantly (muting):

Press the [MUTE] button for more than two seconds to cut the volume or restore it instantly.



- Press and hold the [MUTE] button for more than two seconds if E-COM is connected and less than two seconds if E-COM is not connected to activate or cancel MUTE function.

## Switching playback modes

1. Press the [MODE] button.  
Tap the button to switch modes in the following sequence:

→ Tuner → Disc → PWR OFF (Stand by) →



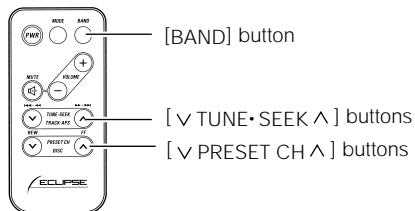

## How to play the tuner

Enter the tuner mode first.

### Select the FM/AM band

1. Tap the [BAND] button.

Each tap will switch tuner modes from FM1 FM2  
FM3 AM.

### Select a station (manually or automatically)

A short tap of the button will allow manual station tuning.  
Pressing for more than one second will start automatic  
tuning.

1. Press the [v TUNE•SEEK ^] button.

[^] button: Tunes to higher frequency stations.

[v] button: Tunes to lower frequency stations.

### Selecting preset stations

A total of six stations may be selected (preset tuning) out  
of those already set in memory through the main unit.  
(Refer to "Manually setting stations into memory," page  
34.)

1. Press the [v PRESET CH ^] button.

[^] button: Selects the next higher number preset button.

[v] button: Selects the next lower number preset button.

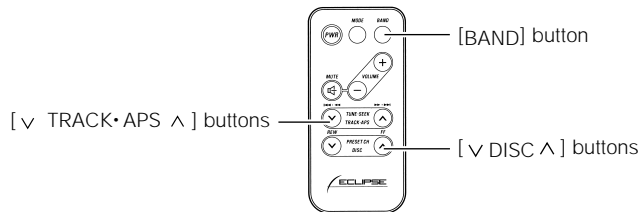

---

## How to play CDs

Select the disc mode first.

### Switching disc modes

1. Press the [BAND] button.

When one or two CD changer is connected, tap the [BAND] button to change modes from CD player CD changer 1 CD changer 2.

The indicator will skip a changer or player that has no discs loaded.

### Advancing to the next track or returning to the beginning of the track being played

1. Press the [∨ TRACK•APS ^] button.

[^] button: Skips to the next track.

[∨] button: Returns to the beginning of the track being played.



- Hold the [^] button down to fast-forward, or the [∨] button to fast-reverse the track being played.

### Skipping to the next or previous CD.

1. Press the [∨ DISC ^] button.

[^] button: Selects the next higher number disc.

[∨] button: Selects the next lower number disc.

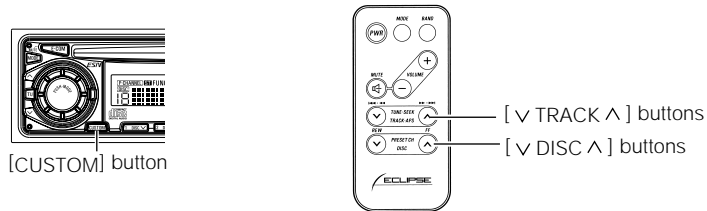

## Switching the remote control settings

Remote control functions can be switched to the three patterns.

1. Press the [CUSTOM] button of the main unit for about one second.
2. Each time the button is pressed, the pattern is switched in the order of A, B, and C so that the E-com function can be supported.

REMOTE A---Conventional functions

REMOTE B---

[DISC ^] button---Repeat

[DISC √] button---Answer

[TRACK ^] button---Next

[TRACK √] button---Previous

Other functions than the above are conventional functions.

REMOTE C---

[DISC ^] button---Option4

[DISC √] button---Option3

[TRACK ^] button---Option2

[TRACK √] button---Option1

Other functions than the above are conventional functions.

## Replacing the battery

### **Warning**

To prevent accidents, store the batteries out of the reach of children. If a child has swallowed one, consult a doctor immediately.

Use one CR2025 battery.

1. On the back of the remote control, while pressing the locking knob on the battery slot cover toward your right, pull out the battery carrier with your fingernail.



2. Remove the old battery, then place the new one in the carrier with the (+) mark facing up.

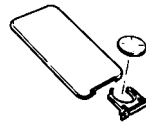

3. Push in the carrier until it snaps into place.

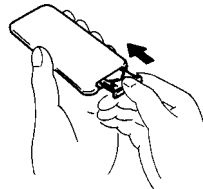

### **Caution**

Be extremely careful not to swallow the battery.

## How to use an optional NOB remote control

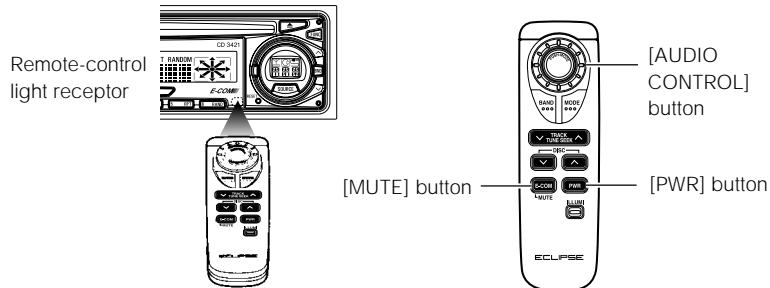

## How to use an optional NOB remote control

### Turning the power on/off

1. Press the [PWR] button.

The power turns on or off each time the button is pressed.



- When the main unit is shut down, the remote control will not work.

### Adjusting the audio volume

1. Press the [AUDIO CONTROL] button, and turn it to the left or right.

Each tap of the button will switch the audio control modes.

Turn to the right : Increases the volume.

Turn to the left : Decreases the volume.

### Cutting the volume instantly (muting):

Press the [MUTE] button for more than two seconds to cut the volume or restore it instantly.



- Press and hold the [MUTE] button for more than two seconds if E-COM is connected and less than two seconds if E-COM is not connected to activate or cancel MUTE function.

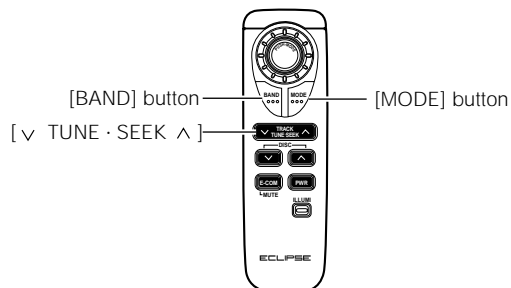

---

## Switching playback modes

1. Press the [MODE] button.  
Tap the button to switch modes in the following sequence:

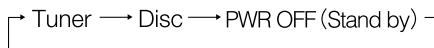

## How to play the tuner

Enter the tuner mode first.

### Select the FM/AM band

1. Tap the [BAND] button.  
Each tap will switch tuner modes from FM1 FM2  
FM3 AM.

### Select a station (manually or automatically)

A short tap of the button will allow manual station tuning. Pressing for more than a second will start automatic tuning.

1. Press the [v TUNE·SEEK ^] button.  
[ ^ ] button: Tunes to higher frequency stations.  
[ v ] button: Tunes to lower frequency stations.

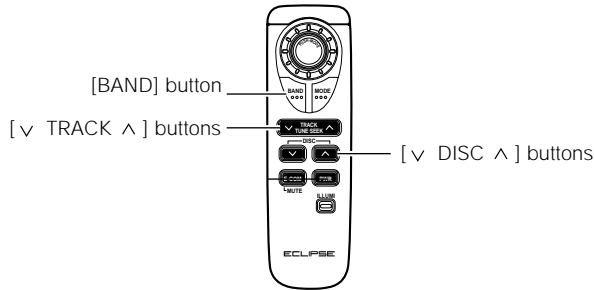

### Selecting preset stations

A total of six stations may be selected (preset tuning) out of those already set in memory through the main unit. (Refer to "Manually setting stations into memory," page 34.)

1. Press the [v DISC ^] button.

[^] button: Tunes the next preset number at a higher frequency.

[v] button: Tunes the next preset number at a lower frequency.

## How to play CDs

Select the disc mode first.

### Switching disc modes

1. Press the [BAND] button.

When the CD changer is connected, tap the [BAND] button to change modes from CD player CD changer 1 CD changer 2.

The indicator will skip a changer or player that has no disc loaded.

### Advancing to the next track or returning to the beginning of the track being played

1. Press the [v TRACK ^] button.

[^] button: Skips to the next track.

[v] button: Returns to the beginning of the track being played.



## How to use an optional NOB remote control

- Hold the [^] button down to fast-forward, or the [v] button to fast-reverse the track being played.

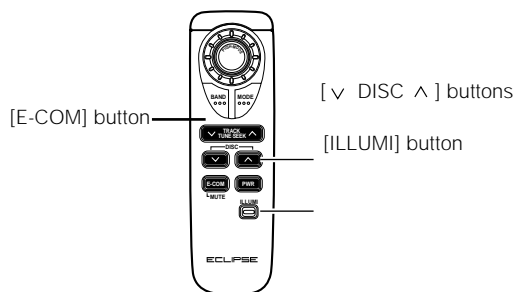

## Skipping to the next disc or back to the beginning of track being played.

1. Press the [v DISC ^] button.

[^] button: Advances the disc number to the upper (next) disc.

[v] button: Returns the disc number to the lower (previous) disc.

## Illuminating the NOB remote control

The buttons of the NOB remote control will be illuminated by pressing the [ILLUMI] button.

## Enabling the optional E-COM feature

Pressing the [E-COM] button for one second will switch the E-COM feature on or off.



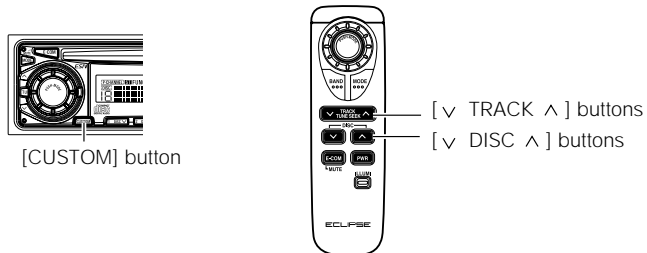

## Switching the remote control settings

Remote control functions can be switched to the three patterns.

1. Press the [CUSTOM] button of the main unit for about one second.
2. Each time the button is pressed, the pattern is switched in the order of A, B, and C so that the E-com function can be supported.

REMOTE A---Conventional functions

REMOTE B---

[DISC ^] button---Repeat

[DISC √] button---Answer

[TRACK ^] button---Next

[TRACK √] button---Previous

Other functions than the above are conventional functions.

REMOTE C---

[DISC ^] button---Option4

[DISC √] button---Option3

[TRACK ^] button---Option2

[TRACK √] button---Option1

Other functions than the above are conventional functions.

## Replacing the battery

### **Warning**

To prevent accidents, store the batteries out of the reach of children. If a child has swallowed one, consult a doctor immediately.

Use two AA cell batteries.

- 1** . Remove the back cover of the remote control unit by gently pressing and sliding it in the direction indicated by the arrow.

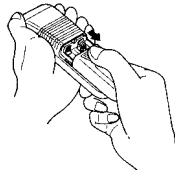

- 2** . Install the two batteries provided into the compartment as illustrated inside the compartment.

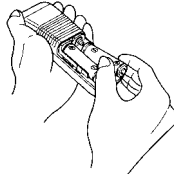

- 3** . Return the back cover into place by sliding it in the direction indicated by the arrow.

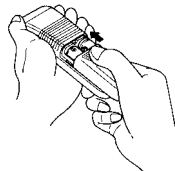

### ***Caution***

---

- Be extremely careful not to swallow the battery.
- The battery life is approximately one year. If the remote control unit does not operate correctly or if the button lamp gets dim, replace the batteries.
- Be sure to orient the batteries correctly so that the positive and negative poles match the diagram.
- Do not use one new battery and one old one; use two new batteries.
- Use only two of the same kind of battery.
- If any liquid is seen leaking from the batteries, remove both batteries and dispose of them properly. Thoroughly clean the battery compartment with a dry cloth. Then install new batteries.

## How to operate the receiver with an optional CD changer connected

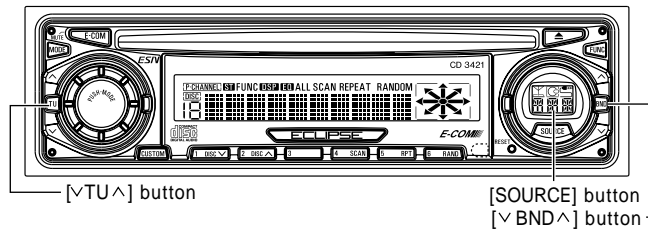

## How to operate the receiver with an optional CD changer connected

### Basic operation

This section covers the operation of the CD changer that is connected to the receiver.

To switch from another mode, press the [SOURCE] button.

### Listening to a CD

1. Press the [v BND ^] button

Each press of the button switches the mode from CD Player CD Changer 1 CD Changer 2.

### Advancing to the next track or returning to the beginning of the track being played

1. Press the [v TU ^] button.

[^] button: Advances to the next track.

[v] button: Returns to the beginning of the track being played.



- Hold down the [^] button to fast-forward, or the [v] button to fast-reverse within the disc being played.

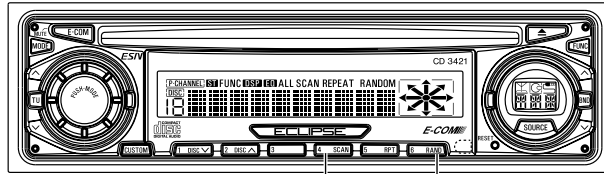

Buttons [4] to[6]

### Playing the beginning of tracks (SCAN):

1. Press button [4 (SCAN)].

Tapping the button causes the changer to move up to the next track and play it for 10 seconds, then move up to the next track and play it for 10 seconds, and so on, on one CD, until the button is tapped again.

Hold the button until the [ALL SCAN] display appears to play the first 10 seconds of the first track of every CD loaded.

### Repeating the same track (REPEAT):

1. Press button [5 (RPT)].

Tapping on the button causes the changer to repeat the track currently being played, until the button is tapped again.

Hold the button until the [ALL REPEAT] display appears to repeat all tracks on the CD being played.

### Playing tracks in random order (RANDOM):

1. Press button [6 (RAND)].

Tapping on the button causes the changer to play the tracks on the currently playing CD in random order.

Hold the button until the [ALL RANDOM] display appears to play tracks from all of the CDs (loaded in the currently selected changer) in random order.

## How to operate the receiver with an optional CD changer connected

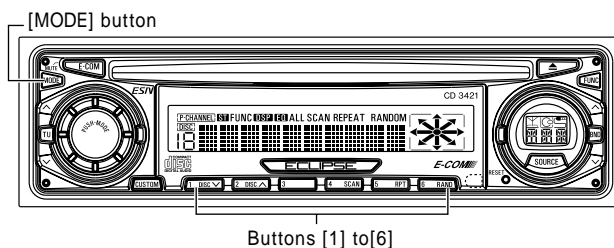

- Occasionally the same track happens to be played (selected) two or more times in a row, but it is no sign of a problem.
- When any of the functions - "Playing the beginning of tracks," "Repeating the same track" and "Playing tracks in random order" - is selected, a message such as [SCAN], [ALL-SCAN], [REPEAT], [ALL-REPEAT], [RANDOM] or [ALL-RANDOM] is displayed at the bottom of the screen to verify the current function.

### Skipping to the next or previous CD

1. Press either button [1(DISC ∨)] or [2(DISC ^)].  
Button [2(DISC ^)] : Selects the next higher number disc.  
Button [1(DISC ∨)] : Selects the next lower number disc.

### Specifying a CD to play

A CD of your choice is directly selectable out of the loaded discs.

1. Press the [MODE] button for less than one second.
2. Press a button from [1] to [6].

Buttons	1	2	3	4	5	6
CDS*	1	2	3	4	5	6
	7	8	9	10	11	12

To select a CD from no. 7 to 12, press the desired button considerably longer.

If you have a question:

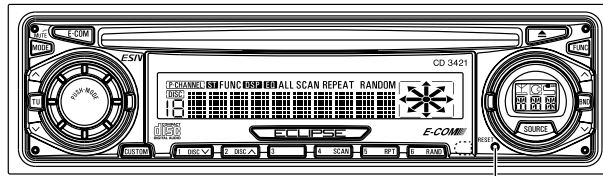

[RESET] button

## ***If you have a question:***

First check the items mentioned below before attempting to troubleshoot problems.

### ***Caution***

- If a problem occurs, for instance when the unit does not respond to any button presses, or the display doesn't work correctly, press the [RESET] button using a sharp tool.

Pressing the [RESET] button will delete all the entries from memory. The settings will return to those made at the factory prior to shipment.

If you have a question:

## Displaying information (for troubleshooting)

The information listed in the chart below is displayed to show the status of the CD player and CD changer. Refer to the chart for the appropriate action.

Information Code Table	When " INFO " flash on the indicator .
○ Information Contents	Explanation and remedial action to take.
2 NO DISK LOADED IN THE MAGAZINE	There is no disc in the magazine or player. Load a disc in the magazine. ( Load a music disc. )
3 DISCS ARE DIRTY OR DAMAGED	The loaded disc is dirty or upside down. Check it for proper orientation and verify it is clean.
5 CD CHANGER FAILS MECHANICALLY	<ul style="list-style-type: none"><li>•The CD changer is inoperative for some reason.Go through the magazine removal procedure.</li><li>•If a magazine fails to eject, have your dealer fix the problem.</li></ul>
6 WHEN THE CDCHANGER INTERNAL TEMPERATURE IS HIGH. ( TO PROTECT PICKUP UNIT )	<ul style="list-style-type: none"><li>•The temperature in the CD changer is too high for operation.Wait until it cools down.</li><li>•Resume playing after the " High temperature sensed and CD stopped " display disappears.If the CD still cannot play , have your dealer repair it.</li></ul>
7 AN INTERNAL POWER SUPPLY FAILURE IS OCCURRING WITH THE AUTO CHANGER	<ul style="list-style-type: none"><li>•Turn the ACC off once before turning it on once again to resume the operation.</li><li>•If the function still cannot be restored, contact your dealer.</li></ul>



If you have a question:

Mode	Problem	Causes	Remedial action to take	Refer to page
Common to all	Dead or weak sound	Is the volume control up sufficiently?	Turn up the volume control.	24
		Is the muting function in effect (MUTE)?	Cancel the muting (MUTE) function.	24
		Is the fader or balance control set far to one side?	Readjust the fader and balance controls to more normal positions.	27
		Other probable causes include broken audio-signal wiring or a faulty speaker.	Have your dealer check the problem.	
	Power does not turn on.	Are too many electrical items installed, causing a lack of power?	Have your dealer check the problem.	
		Other probable causes include a run-down car battery, broken power or interconnection wiring.	Have your dealer check the problem.	
	Frequencies or titles set in memory are deleted.	Has the car battery been disconnected for repair or checked out?	Reenter them into memory.	33 34
		Are too many electrical items installed and causing lack of available power?.	Have your dealer check the problem.	
		Other probable causes include run-down car battery, broken power or interconnection wiring.	Have your dealer check the problem.	
	No guide tone sounds.	Is the guide tone disabled?	Enable the guide tone.	25
	The remote control does not work.	Is the battery low?	Replace battery.	44 50
		Is the battery installed in reverse polarity?	Reinstall the battery in the correct polarity.	44 50
		Is direct sunlight hitting the remote control light receptor?	Use the remote control close to the receptor.	40 45
Other probable causes include a malfunctioning remote control.		Have your dealer check the problem.		

If you have a question:

Mode	Problem	Causes	Remedial action to take	Refer to page
CD	The disc cannot be inserted. The disc is ejected as soon as it is inserted. Or, the disc cannot be ejected. The disc cannot be changed.	Is an extra label or seal applied to the disc?	Do not apply labels or seals to the disc.	12
		Are there rough edges, deformations or damaged areas on the disc?	Try inserting another disc. Removed any burrs. Do not use a deformed or damaged disc.	13
	Sound skips around. Sound is intermittent. Sound is bad in quality.	Is the disc damaged? (scratched, warped, etc.)	Try another disc. Do not play a damaged disc.	12
		Is the disc clean?	Clean the disc.	14
		Is the player mounted at a proper angle? Is the player mounted loosely?	Have your dealer check it out.	
		Are you driving over a rough surface?	Avoid playback while driving over rough surfaces.	10

Problem	Causes	Remedial action to take	
Receives no stations, or receives static noise.	Is the antenna retracted?	Extend the antenna.	
	Is the tuner correctly tuned to a station?	Tune to a station.	32
	Are you driving outside the service area of your preset stations?	Tune to a local station. (Please note, there may be no local stations servicing the area where you are currently driving.)	32
	Are you operating other equipment with a computer, or a mobile phone, in your vehicle at the same time as your receiver?	Avoid operating such equipment while using the receiver.	
	Other problems may include a loose or disconnected antenna cable, a bad antenna cable or a bad antenna	Have your dealer retailer check the problem.	

## ***Specifications***

### **<GENERAL>**

Power Supply	14.4V DC (11-16V)
Current Drain	3A (1W x 4)
Dimensions (W x H x D)	
In-Dash Unit	7 x 2 x 6-1/8 (178 x 50 x 155mm)

### **<FM TUNER>**

Frequency Range	87.75~107.9MHz (200kHz step)
Usable Sensitivity	13dBf
50dB Quieting Sensitivity	21dBf
Frequency Response	30~15,000Hz, $\pm 3$ dB
Stereo Separation	38dB (1kHz)

### **<AM TUNER>**

Frequency Range	530~1,710kHz (10kHz step)
Usable Sensitivity	20 $\mu$ V

## Specifications

---

### <CD SECTION>

Frequency Response	20~20,000Hz, $\pm$ 3dB
Wow & Flutter	Below measurable limits
Stereo Separation	73dB
S/N Ratio (A-weighted)	96dB
Dynamic Range	95dB
Total Harmonic Distortion	0.03%

### <AUDIO AMPLIFIER>

Power Output	13W $\times$ 4 (20~20,000Hz, 0.08% THD , 4 $\Omega$ ) Max .43W $\times$ 4
Output Level/Impedance	2.7V (0dB) / 330 $\Omega$ line-out impedance
Tone Action	• Bass: $\pm$ 10dB at 100Hz • Treble: $\pm$ 10dB at 10kHz
Loudness	+10dB at 100Hz / +6dB at 10kHz

## Before Installation

### Notes

Be sure to disconnect the battery negative terminal before installing the receiver.

### Components

No.	Item	Q'ty
1	Main unit	1
2	Mounting sleeve	1
3	Side bracket	2
4	Rear bracket	1
5	Bezel	1
6	Bushing	1
7	Self-tapping screw (6 x 16 mm)	2
8	Stud bolt	1
9	Flat head screw (5 x 8 mm)	4
10	Hex-head bolt (5 x 20 mm)	2
11	Hex nut (5 mm)	2
12	Interconnecting cable	1

### Setting the system-selector switch

When this receiver is used in combination with an external amplifier, DSP, etc., the selector switch on the left side of the main unit may have to be switched.

Set the switch according to the table below:

External amplifier	DSP/EQ/XOVER	Switch
None	None	OFF*
None	Connected	ON
Connected	Connected	OFF*
Connected	None	OFF*

\* :Pattern of selector switch at shipping

MAIN UNIT LEFT SIDE VIEW

## Mounting instruction

### Mounting the main unit

1. Insert the mounting sleeve into the opening in the vehicle console.
2. Use a screwdriver or the like to bend the tabs in the mounting sleeve to secure the mounting sleeve.

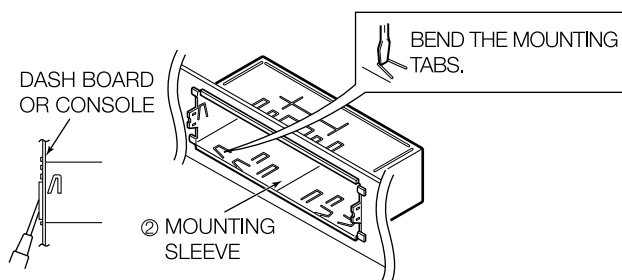

3. Attach the side brackets to the main unit using flathead screws.

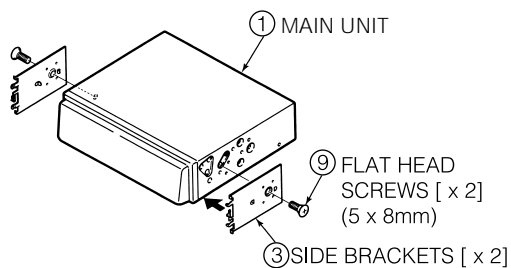

- 4 . Mount the stud bolt to the main unit.
- 5 . Insert the main unit into the mounting sleeve until it locks in place.
- 6 . Fasten the rear of the main unit using either method [A] or [B].  
Select method [A] or [B] to suit the interior configuration of the vehicle.
- 7 . Install the bezel on the main unit.

[A]

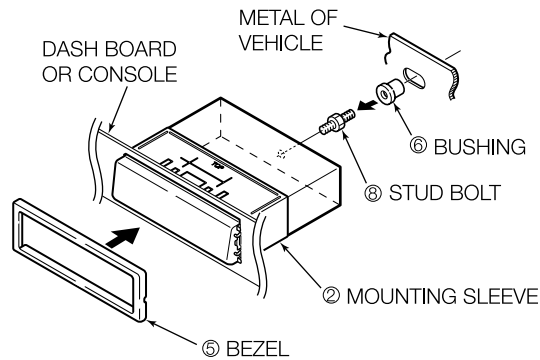

[B]

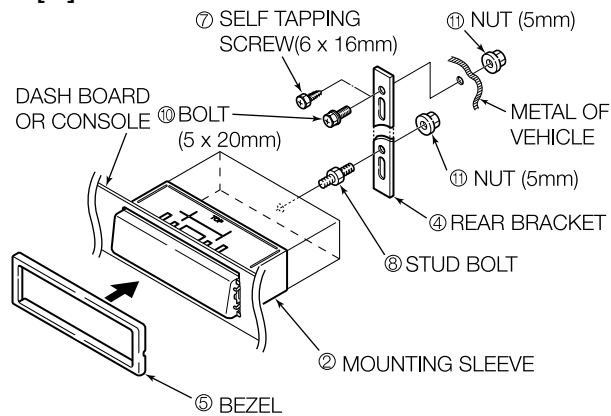

## Notes

To prevent unconnected leads from shorting out, insulate them by wrapping their tips with electrical tape. Similarly, insulate the ends of connected leads.

If an external amplifier is to be connected to the receiver, be sure to ground its outside housing to the vehicle body (a metal part).

## Names of lead wires and destinations

(refer to Page 66)

No.	Name	Wire color	Destination
1	ACC	Red	Connect where the power comes on when the ignition is in the ACC position.
2	B+	Yellow	Connect where the power is constantly available, regardless of the ignition switch's position.
3	Ground	Black	Connect where good body grounding is available.
4	Antenna power supply	Blue	Connect to the automatic-antenna control terminal of the vehicle.
5	Lamp power supply	Orange/White	Connect to where power comes on when the headlights are turned on.
6	Control power supply	Blue/White	Connect to the control terminal for the external amplifier, etc.
7	E-LAN terminal		Connect to the E-LAN terminal of the CD changer, DSP, etc.
8 & 9	Line-out terminals		Connect to the RCA input connectors of an external amplifier.
10	Line-out terminals (Nonfader)		Connect to the RCA input connectors of a woofer amplifier.
11	Speaker terminals		Connect them to their respective speakers.
12	Cellular phone mute	Pink	Connect the ground output terminal on a mobile phone.
13	Digital out terminal		Connect to digital input terminal of the Eclipse Commander module.
14	Eclipse Commander terminal		Connect to the Eclipse Commander.



## System

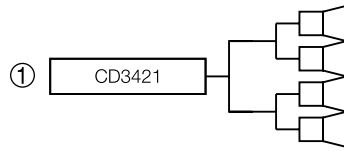

**Note:**  
Adjust the external  
amplifier's input level.

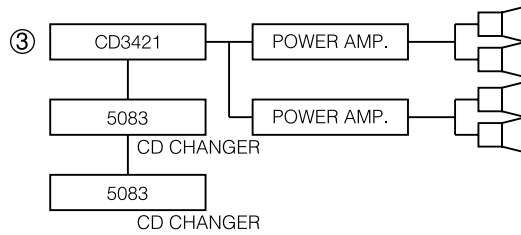
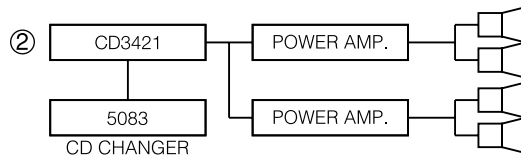

1) CD3421 Receiver, used alone

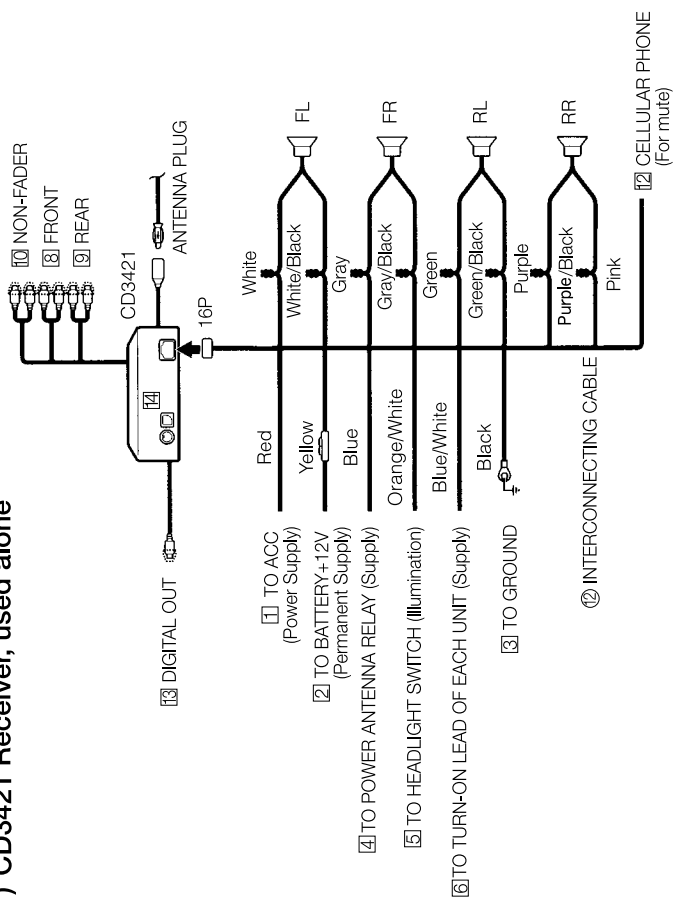

## 2) CD3421 + 5083 + Power Amplifier

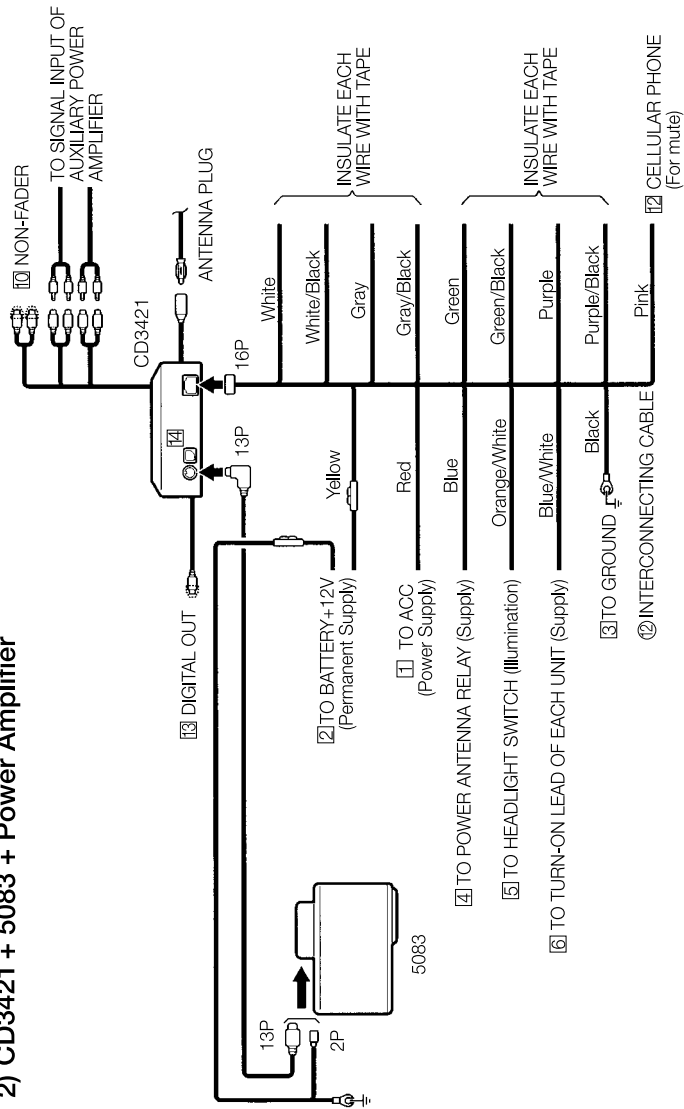

3) CD3421 + 5083 + 5083 + Power Amplifier

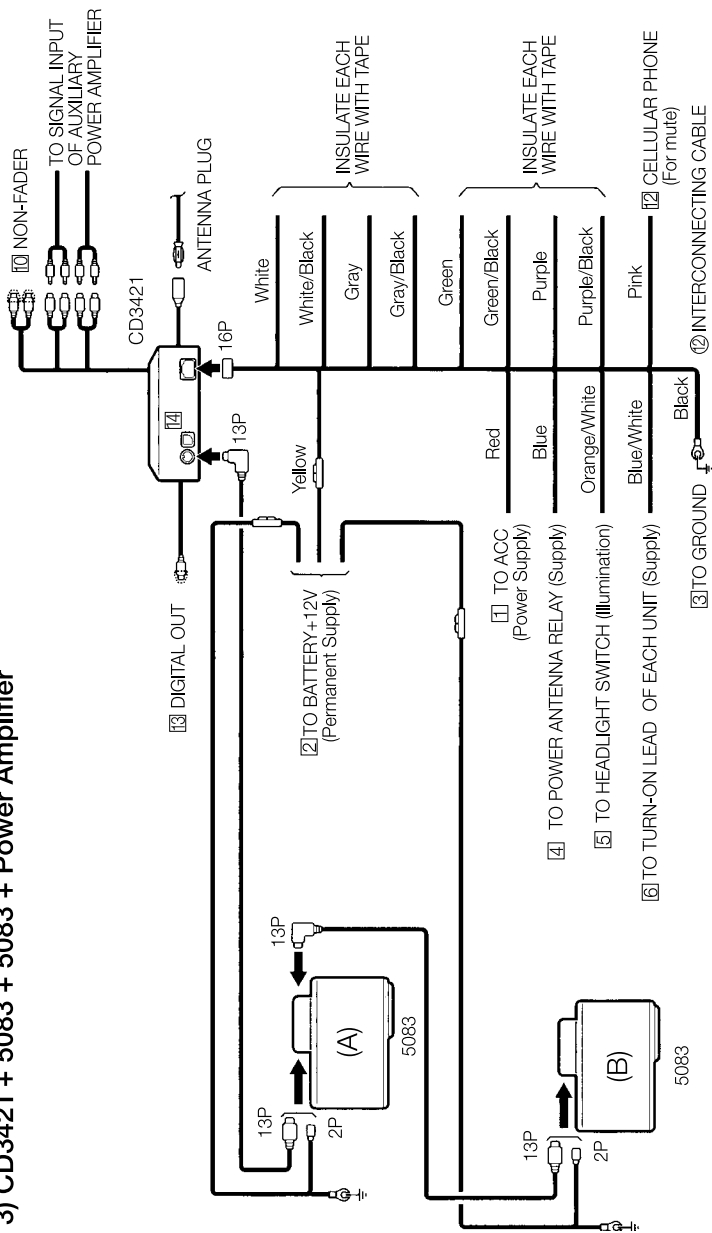



*MEMO*

---

# **IMPORTANT**

**RECORD YOUR "KEY  
CD" HERE...**

---

---

---

**STORE YOUR "KEY CD"  
ALONG WITH YOUR  
OWNER'S MANUAL IN  
YOUR SOCK DRAWER.**



This device complies with part 15 of the FCC Rules. Operation is subject to the condition that this device does not cause harmful interference.

CUSTOMER NOTICE

Please retain this booklet and write in the serial number of your CD3421 for identification. The serial number is labeled or stamped on the chassis.

Serial No. \_\_\_\_\_



DIVISION OF FUJITSU TEN CORP. OF AMERICA  
19600 SOUTH VERMONT AVENUE, TORRANCE, CA 90502  
(310) 327-2151

090001-13970700  
0011DE(N.O.)



## Free Manuals Download Website

<http://myh66.com>

<http://usermanuals.us>

<http://www.somanuals.com>

<http://www.4manuals.cc>

<http://www.manual-lib.com>

<http://www.404manual.com>

<http://www.luxmanual.com>

<http://aubethermostatmanual.com>

Golf course search by state

<http://golfingnear.com>

Email search by domain

<http://emailbydomain.com>

Auto manuals search

<http://auto.somanuals.com>

TV manuals search

<http://tv.somanuals.com>