

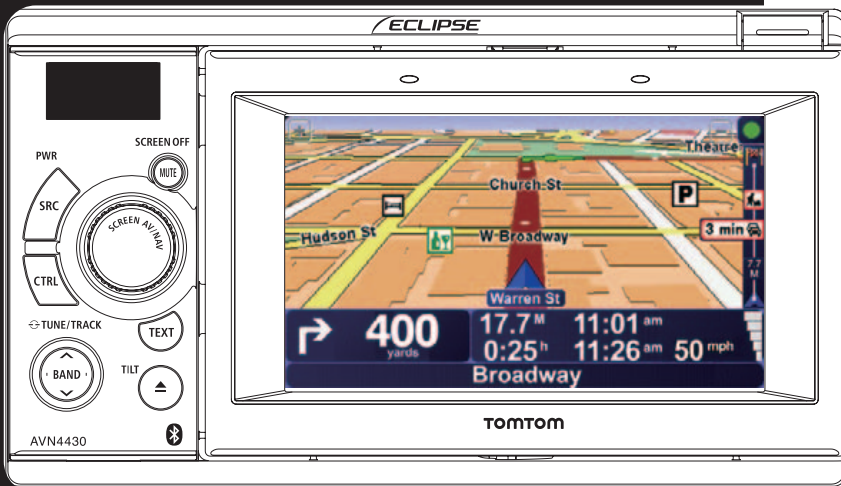

OWNER'S MANUAL



AVN4430

DVD-Video / USB Multi-Source Receiver / 4.3"
Portable Navigation / Built-in Bluetooth[®]
wireless technology

We appreciate your purchase of this receiver.
Please read through this manual for correct operation.
We suggest that after reading it you keep this manual
in a safe place for future reference.

The symbols described below are found in this instruction manual as well as on the device itself to insure its proper and safe usage and to prevent injury or damage to property. Make sure you understand the meaning of these symbols before reading the rest of this manual.

Precautions for Use

The following symbols will precede information useful for preventing damage to the main unit as well as for its smooth operation.

WARNING

This sign indicates a situation in which incorrect handling through disregard of a sign might result in death or serious personal injury.

CAUTION

This sign indicates a situation in which incorrect handling through disregard of a sign might result in personal injury or may result solely in damage to property.

IMPORTANT

Follow this advice to prevent malfunctions or damage to the main unit. Perform the indicated action in the event of a malfunction.

ATTENTION

Useful information for the smooth operation of the main unit.

CHECK

Facts to keep in mind when operating the main unit.

- Please read all materials such as manuals and warranties that have come with the product. ECLIPSE will not be responsible for unsatisfactory product performance due to failure to follow these instructions.
- Changes to product specifications may result in differences between content of the manual and features of the product.

Before Use

1. Safety precautions.....	8
2. Before use	12
Discs	14

Operation

1. About This Receiver	17
Control Names and Operations.....	17
Panel Switches.....	17
Turning the POWER ON or OFF	18
Switching Between the Audio and Navigation Screen	18
Turning the PND Display ON and OFF	19
Detaching the PND	19
Using the PND.....	19
How to Detach the PND from the Main Unit.....	19
Attaching the PND.....	19
Using the Audio Cover.....	20
Using the Audio Cover	20
Fitting the Audio Cover.....	20
How to Detach the Audio Cover from the Main Unit.....	20
Hands-Free Microphone and Light Sensor	20
Adjusting the Display Angle.....	21
Loading/Unloading a Disc	22
Loading Steps	22
CD/DVD unloading steps	23
Operation Conditions of this Receiver	24
2. Setup of This Receiver	25
Setup of This Receiver.....	25
Main Unit Settings	25
Enable guide tone	25
Enable AUX.....	25
Enable VTR.....	26
Dim sub-display.....	26
Link night view to headlights	26

Illumination	26
Voice guidance	27
Camera setting	27
Radio area	27
Screen Adjustment and Setting	27
Picture Quality Adjustment	28
Contrast	28
Brightness	28
Color	28
Tint (only for NTSC)	28
Switching the Wide Screen Mode	29
3. Switching the Audio Source	30
Switching the audio source	30
4. Volume Control	31
Adjusting the volume	31
Muting the Volume	31
5. Adjusting the sound quality	32
Switching Audio Control Modes	32
Adjusting the BASS	32
Adjusting the MIDDLE	32
Adjusting the TREBLE	32
Balancing the Right and Left Speakers (BALANCE)	32
Balancing the Front and Rear Speakers (FADER)	32
Adjusting non-fader level (NON-FADER LEVEL)	32
Selecting phase (NON-FADER PHASE)	33
Adjusting frequency filtering settings (Low Pass Filter for Sub-Woofer output)	33
Setting the loudness mode (LOUDNESS)	33
Adjusting the SVC (Source Volume Control)	33

Audio operations

1. Using the Radio	34
Listening to the Radio	34
Tune a Desired Station	34
Manual Tuning	34
Auto Tuning	34

Selecting a Preset Channel.....	35
Touching a Preset Switch.....	35
Selecting a Radio Band.....	35
Saving a Station in Memory.....	35
Manual Saving.....	35
Auto Station Memory (ASM).....	36
Preset Scan.....	36
Showing the current frequency on the sub-display.....	36
2. How to use the SIRIUS satellite radio.....	37
Listening to SIRIUS satellite radio.....	37
Check the SIRIUS ID.....	37
Changing the SIRIUS band.....	38
Selecting the channel you want to listen to.....	38
Searching the channel upward or downward within the selected category.....	38
Selecting a category.....	38
Selecting a channel.....	38
Selecting a channel by direct input.....	38
Memorizing Channels.....	39
Selecting a preset channel.....	39
Preset Scan.....	39
Displaying information about the current broadcast on the sub-display.....	39
3. How to use the XM satellite radio.....	40
Listening to XM satellite radio.....	40
Checking the RADIO ID.....	40
Changing the XM band.....	41
Selecting the channel you want to listen to.....	41
Searching the channel upward or downward within the selected category.....	41
Selecting a category.....	41
Selecting a channel.....	41
Selecting a channel by direct input.....	41
Memorizing Channels.....	42
Selecting a preset channel.....	42
Preset Scan.....	42

Displaying information about the current broadcast on the sub-display	42
4. Using the CD Player	43
Listening To a CD	43
Selecting a Desired Track.....	43
Fast Forward/Rewind	44
Finding a Desired Title	44
Repeating the Same Track.....	44
Random Play.....	45
Displaying the information on the sub-display	45
5. Using the MP3/WMA Player	46
Playing an MP3/WMA File	46
Selecting a Desired Folder	47
Selecting a Desired Music File	47
Fast Forward/Rewind	47
Returning To the Root Directly	47
Finding a Desired Music File	48
Repeating a Music File.....	48
Random Play.....	49
Displaying the information on the sub-display	50
Switching Between CD-DA and MP3/WMA	50
MP3/WMA	51
Playable MP3 File Standards	51
Playable WMA File Standards.....	51
ID3/WMA Tags	52
Supported Media Types	52
Format of Discs	52
File Names	53
Multi-sessions.....	53
Playing MP3/WMA	54
MP3/WMA Playing Time Display.....	54
Creating and Playing MP3/WMA Files	54
Downloading From an MP3/WMA Music Site of Internet	54
Converting a Music CD into MP3/WMA Files.....	54
Writing MP3/WMA Files On a CD-R/RW Disc.....	55

When Playing Back CD-R/RW	55
6. Using the USB Music File Player.....	56
Playing USB Music Files.....	56
Fast Forward/Rewind	56
Selecting a Desired Music File	57
Finding a Desired Music File	57
Repeatedly Playing the Same Music File	58
Random Play of Music Files	58
About USB devices	58
Playable USB Memory Standards.....	58
Playable MP3 File Standards	58
ID3 Tags.....	58
Format of USB Memory.....	59

Visual operations

1. Before Using the DVD Player.....	60
Advantages of Digital Versatile Disc (DVD)	60
Multi-Audio Function.....	60
Multi-Angle Function.....	60
Subtitle Display Function.....	60
Discs	61
Types of Playable Discs	61
Region Code of Playable Disc.....	61
Mark Indicated on Disc.....	62
Disc Configuration	62
Products equipped with Macrovision.....	63
Operation Flow	63
2. Using the DVD Player	64
Watching a DVD Video	64
Video Operations.....	64
Playing a Video	65
Fast Forward/Rewind	65
Fast Forwarding or Rewinding Using Panel Switch	65
Fast Forwarding or Rewinding Using Touch Switches.....	65
Pausing a Video	65
Stopping a Video	65

Disc Menu Operations.....	66
Finding a Desired Video.....	66
Finding by Chapter.....	66
Finding by Title Number.....	66
Finding by chapter number.....	67
Changing the Touch Switch Display	67
Hiding the Touch Switch.....	67
Relocating the Touch Switch Display.....	68
Changing the Screen Display and Audio Mode.....	68
Changing the Angle.....	68
Changing the Subtitle Language.....	69
Changing the Audio Language.....	69
DVD Player Setting	70
Specifying the Audio Language.....	70
Entering the Code	71
Specifying the Subtitle Language.....	71
Entering the Code	72
Specifying the Menu Language.....	72
Entering the Code	72
Specifying the Parental Screening Level.....	73
Switching the Video Output.....	74
Language Code List.....	75
3. Using the VTR	76
Switching the VTR Mode ON and OFF.....	76
Playing the VTR.....	77
Changing the VTR Setting Screen	77
Turning Off the VTR.....	77

How to operate portable audio devices

1. Using the iPod Player.....	78
Listening to the iPod.....	78
Fast Forward/Rewind	79
Selecting the Desired Music or Video File.....	79
Finding a Desired Music File.....	79
Setting to the iPod Video Mode.....	80
Playing.....	81

Pausing.....	81
Repeatedly Playing the Same Music File	81
Random Play of Music Files	81
2. Using the AUX.....	82
Switching the AUX Mode ON and OFF	82
Listening to the Portable Audio Player	83

Others

1. About the Steering Wheel Switches	84
Manual setting of steering wheel switch functions.....	84
Compatibility with Steering Wheel Switches	85
2. Backeye Camera Operations	87
Playing a Video through the Backeye Camera	88
When the Camera Is Set to MANUAL or AUTO.....	88
When the Camera Is Set to AUTO	88

Reference

1. Necessary Information	90
If the Following Messages Appear.....	90
When You Think There Is a Malfunction	93
2. Specifications	95
3. How to Contact ECLIPSE	97

Safety precautions

WARNING

- Do not modify this system for any uses other than that specified herein. Also, do not deviate from the installation procedures described herein; Eclipse will not be held liable for damages including, but not limited to serious injury, death or property damage resulting from installations that enable unintended operation.
- This main unit requires 12V DC and should only be installed in a vehicle with a 12V negative ground electrical system. Any other installation use other than its intended use may cause severe damage to the main unit as well as shock or personal injury.
- Never install this main unit where it will interfere with safe operation of the vehicle.
- Never block the drivers' view. Do not install main unit where it may interfere with operation of the brakes, the steering or any safety systems, including seat belts and air bags.
- Before drilling holes in a vehicle for installation, you must confirm the locations of pipes, tanks, electrical wiring, and other vehicle systems and components to ensure that there will be no interference or contact. In addition, you must also apply rust prevention and leak prevention measures at the drilling area. Otherwise, fire or electric shock could occur.
- When installing the main unit, do not remove or alter existing vehicle fasteners, including nuts, bolts, screws, clips, and fittings. Never detach, move or alter existing vehicle wiring, including electrical grounds and straps. Alteration of existing vehicle components may make vehicle unsafe to operate.
- Before installation, remove the negative (-) battery terminal to prevent shocks, electrical arcing, fires, and damage to vehicle wiring and the main unit you are installing.
- Secure wiring with non-conductive tape or plastic ties so that wires do not interfere with vehicle operation, including the brake pedal, gear shifter and steering. Position wires so that they will not be rubbed, abraded, or damaged by moving vehicle components, including power seats.
- To avoid damage to the main unit and vehicle, including fire, never supply power to an installed main unit in a way that will overload the capacity of an existing vehicle circuit. Never leave a power supply wire or connection uninsulated. Always install supplied fuses, circuit breakers, and relays.
- Air bags are a vital part of a safety system. Never install main unit in a way which will alter air bag wiring or interfere with air bag deployment. Air bags must function properly in the event of an accident.
- When installation is complete, test all vehicle electrical systems to ensure they operate correctly, including lights, horn, brake lights, and emergency flashers.
- For your protection, never use a power drill without wearing safety glasses or goggles. Debris or broken drill bits may cause severe eye injuries, including blindness.
- Use electrical tape to insulate the ends of all wires, even if they are not used. Proper insulation prevents arcs, shocks and fires.
- Some devices require the use of batteries. Never install main unit where young children can get access to batteries. If a battery is swallowed, seek immediate medical attention.
- When the vehicle is in motion, never take your eyes off the road to make adjustments to the main unit. You must pay attention to the road at all times to avoid accidents; do not let operation or adjustment of the main unit distract you from operating the vehicle responsibly.
- The driver should not look at the screen while driving. Doing so may result in an accident.
- Do not place foreign objects in the disc insertion slot or USB input terminal. Fires or shocks may result.

- Do not disassemble or alter this main unit. Doing so may result in an accident, fire or shock.
- Do not let water or foreign objects enter the internal parts of this main unit. Doing so may result in smoke, fire or shock.
- Do not use when main unit is malfunctioning (the screen is not lit or no sound comes out). Doing so may result in an accident, fire or shock.
- Always replace fuses with fuses of identical capacity and characteristics. Never use a fuse with a higher capacity than the original fuse. Using the wrong type of fuse may cause a fire or severe damage.
- If foreign objects or water enters the main unit, smoke or a strange odor may be emitted. If this occurs, stop using the main unit immediately and contact your dealer. Accidents, fire, or shocks may result if you continue to use the main unit under these conditions.
- The driver should not change the Disc or USB memory while driving. Doing so may result in an accident. You must first stop or park your car in a safe location and then proceed to remove or insert the Disc and/or USB.
- Plastic bags and wrappings may cause suffocation and death. Keep these objects away from babies and children. Never place bags or wrappings over anyone's head or mouth.
- Be sure to park the vehicle in a safe location and set the parking brake before watching DVDs or videos. For safety reasons, only the sound of DVDs or videos will be emitted while the vehicle is in motion.

Safety precautions

CAUTION

- Wiring and installing this main unit requires expertise and experience. Professional installation is recommended. Consult with your dealer or a professional installation expert. Incorrect wiring may damage the main unit or interfere with safe operation of the vehicle.
- Use only specified accessory parts. Using other parts may cause damage to the main unit or cause parts to dislodge and fall or fly off the main unit.
- Do not install the main unit in places where it may be exposed to dew condensation (around the air conditioning hose, etc.), or in locations where it may come in contact with water, high levels of moisture, dust or oily smoke. If water, moisture, dust or oily smoke enters this main unit, smoke, fires or malfunctions may result.
- Do not install in places subject to direct sunlight or where it may be hit directly by hot air from the heater. This may increase the interior temperature of this main unit, resulting in fires and malfunctions.
- Do not impede the air flow of the heat sink or vents of this main unit. Impeding the air flow will cause the interior of the main unit to overheat, and fires may result.
- Connect as specified in the installation manual. If not connected correctly, fires or accidents may result.
- Install wiring in a manner in which cables will not be pinched by movable parts such as seat rails, and screw parts of the vehicle body. Accidents, fires and shocks may result from disconnection and electrical shorts.
- Install wiring in a manner in which cables will not come in contact with metal parts. The wiring may be damaged by contact with metal parts, resulting in fire and shocks.
- Avoid all contact with hot surfaces when wiring the main unit. High temperatures may damage wiring, causing shorts, arcing and fires.
- When changing the installation location for this main unit, please consult the dealer where you bought it for safety reasons. Expertise is necessary for removal and installation.
- Keep volume to a reasonable level so that you can hear sounds from outside the vehicle, including warning sounds, voices, and sirens. Failure to do so may cause an accident.
- Be careful that your hands and fingers do not get pinched when adjusting the tilting angle or closing the display. Injuries may result.
- Do not put your hands or fingers into the disc insertion slot or USB input terminal. Injuries may result.
- Do not touch heat dissipating parts of the main unit as you may be burnt.
- The volume should be set at a moderate level to avoid hearing damage when the main unit is powered on.
- Do not operate when sound such as distortion is being emitted.
- This main unit uses invisible laser light. Do not disassemble or alter this main unit. If any problems occur, contact the dealer where you purchased the main unit. Altering this main unit may cause exposure to laser emissions (which may damage your eyesight), or result in an accident, fire or shocks.
- If the main unit is dropped or the cosmetics appear broken, turn off the power to the main unit and contact your dealer. If used in this condition, fires or shocks may result.
- Using the vehicle speed pulse signal, you can use the route guidance function even in the locations where usually no guidance is given (example: in a tunnel). However, the accuracy of the guidance is not guaranteed.

IMPORTANT

- When there is a lot of vibration – when driving on a bad road for example – the main unit may become inoperable due to it not being able to read data from the disc.
 - Condensation may accumulate on the lens, with the function requiring reading of CDs and DVDs, immediately after turning ON the heater in cold temperatures. Wait approximately 1 hour for the condensation to evaporate and for the device will operate normally.
Contact the store where you purchased the device if normal operation does not resume after several hours.
 - If using this receiver immediately after having purchased it or after having stored it disconnected from the vehicle battery, the present location may not be displayed accurately. Wait a short while and the GPS positioning will correct the displayed position.
 - This device is a precision-engineered equipment and the information that you record on it after purchase can be lost as a result of static electricity, electrical noise, vibration and other influences. It is recommended that you keep a separate record of the information you store in the main unit.
 - Note that the following events are not covered by the warranty.
 - ① Corruption or loss of the data stored in the main unit by the purchaser resulting from failure or incorrect operation of the main unit, or any problems associated with it, or due to the effects of electrical noise or other influences.
 - ② Corruption or loss of the data stored in the main unit by the purchaser resulting from misuse of the main unit by the purchaser or a third party.
 - ③ Corruption or loss of data stored in the main unit by the purchaser resulting from failure / repair of the main unit.
- * Please note that by installing or using the main unit, you are regarded as having consented to the points above.

Before use

⚠ CAUTION

- Be very careful and pay full attention to safety when operating the audio controls while driving. Otherwise accidents may occur. Also, be sure to set the volume so that you can still adequately hear sounds outside the vehicle.

Improper use may result in a traffic accident.



- Never continue to use the system if it is malfunctioning in any way. If smoke, abnormal noises or abnormal odors are noticed, turn off the power immediately. Immediately turn off the audio in such situations.

Exercise caution regarding the temperature inside the vehicle.

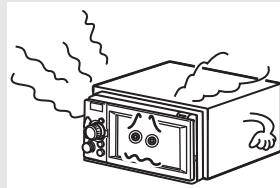

- The temperature inside the vehicle can increase during hot weather.

Wait for the temperature inside the vehicle to drop before using this receiver.

Otherwise damage may result.

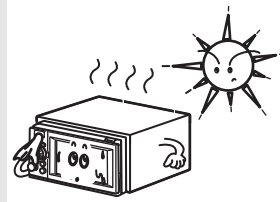

- Do not disassemble or modify this receiver.

The main unit has a precisely designed structure, so consult your retailer in the event any unsatisfactory performance is observed.

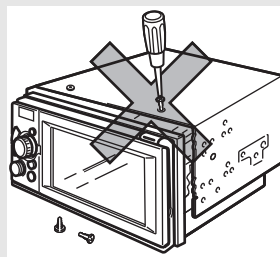

- Do not apply excessive force to the monitor.

Otherwise damage may result.

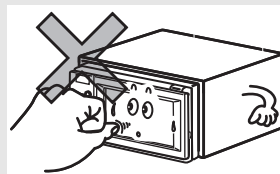

- Do not leave the monitor in tilt position when you are not using it.

Otherwise, it may be damaged.

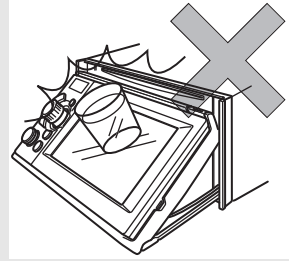

- Do not insert any objects other than discs into the disc slot.

Otherwise damage may result.

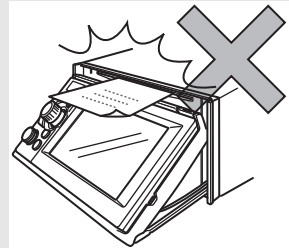

- Be careful not to get your fingers or other objects caught behind the monitor when it is being retracted into place.

Interference can cause an injury or damage the main unit.

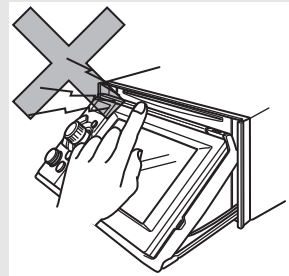

- When removing a disc from the main unit, remove it in the horizontally level direction.

Do not pull them up or press down on them forcibly while removing them.

Improper removal may result in the disc becoming scratched, cause the receiver to emit unusual noises, or result in other damage.

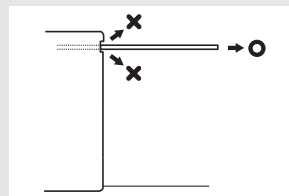

Before use

Discs

ATTENTION

- In cold or rainy weather, just as the interior glass surface becomes fogged, dew (water condensation) may also settle on the main unit. When this occurs, disc playback may become intermittent or impossible. Dehumidify the air in the vehicle for a while before resuming playback.
- If a problem occurs, the player function stops automatically to protect its internal parts. If the player does not operate even when you follow the on-screen messages, the player may have failed. Consult the dealer you purchased it from.
- Playback may be intermittent when the player is subjected to severe vibrations while traveling over a rough surface.
- Please do not use a commercially available lens cleaner because it may cause damage to the pickup of the player.

Format of discs

- An audio disc or DVD video disc bearing one of the marks below can be played.

When using a DVD±R/RW (DVD±Recordable/ReWritable) disc, note that only the disc whose contents were recorded in the video mode can be played. Discs whose contents were recorded in the video recording (VR) mode and audio mode cannot be played.



- The Dolby Digital format is supported, and a disc having the following logo can be played.



This product is manufactured under license from Dolby Laboratories. Dolby and the double-D symbol are registered trademarks of Dolby Laboratories.

- It is possible that a CD-R (CD-Recordable) or CD-RW (CD-ReWritable) disc will not play on the main unit due to the characteristics of the recording or special disc, scratches, dirt or deterioration caused by long-term storage in the vehicle. Also, a CD-R or CD-RW disc that has not yet been finalized and a CD-R or CD-RW disc recorded in UDF format cannot be played.
- It is possible that a DVD±R/RW (DVD±Recordable/ReWritable) disc will not play on this receiver due to the characteristics of the recording or special disc, scratches, dirt or deterioration caused by long storage in the vehicle. Also, a DVD±R/RW disc that has not yet been finalized cannot be played. It may not be possible to play a disc that has been recorded on a personal computer, depending on the application setting and the environment.
- The CD-TEXT function can be used only for CD-text CDs available on the market. Characters written on a CD-R and CD-RW discs may not be displayed correctly.
- Do not use a CD and a See Through disc having a transparent or semi-transparent recording area as they may fail to load or unload or play their contents.

- A Copy Control CD (CCCD) may not be played as it does not meet the official CD Standard.



■ Handling discs

- Do not place a disc in direct sunlight; store each disc in their protective cases. Otherwise, discs may warp and fail to play.

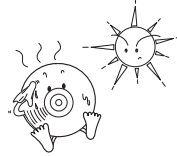

- Do not apply paper-based tape to either the recording side or label side of a disc. Damage could result.

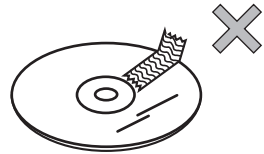

- Keep cracked or warped discs out of the player to avoid damaging the main unit.



- Do not touch the recording area (the rainbow colored) side of a disc. Otherwise, the disc may become dirty and playback may be intermittent.



- If you play a dirty disc, the disc surface may be scratched and its play may be intermittent. Use a commercially available compact disc cleaner to clean a CD, wiping gently from the center to the edge.



Before use

■ Brand new CDs

- You may notice that some brand new discs are rough around the center hole or outside. In this case, remove burrs or flakes around the edge using the side of a ballpoint pen before using a new disc. Not doing so may result in burrs or flakes becoming stuck on the recording side, preventing playback.

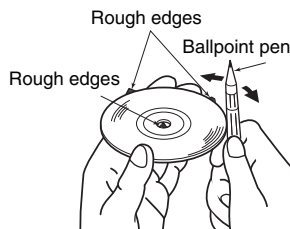

■ Rental discs

- Do not use a rental disc with glue or remnants of adhesive tape or labels. They may cause the disc to get stuck inside or damage the main unit.

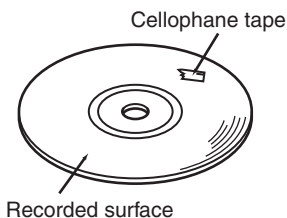

■ Irregularly-shaped CDs

Specially-shaped or octagonal CDs, like heart-shaped cannot be played. Do not attempt to play them, even with an adapter, since they may damage the player.

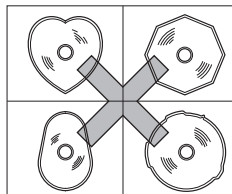

■ Disc accessories

- Do not use accessories (stabilizers, protective seals, laser lens cleaners, etc.) sold for "improving sound performance" or "protecting CDs." The changes in CD thickness or outside dimensions made by these accessories may cause problems in the player.
- Please be sure NOT to attach any ring-shape protector (or other accessory) to your discs. Those protectors are commercially available and said to protect discs and to improve sound quality (and antivibration effect), but they can do more harm than good in regular uses. The most common problems are Insert/Eject related problems and "No playback" problems due to the protector ring that may have come off in the disc mechanism.

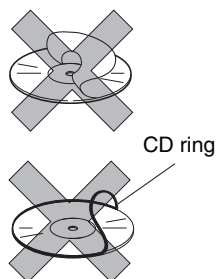

About This Receiver

Control Names and Operations

You can operate this receiver by pressing the panel buttons (panel switches) or by touching the switches displayed on the screen (touch switches).

■ Panel Switches

Press each panel switch to operate it.

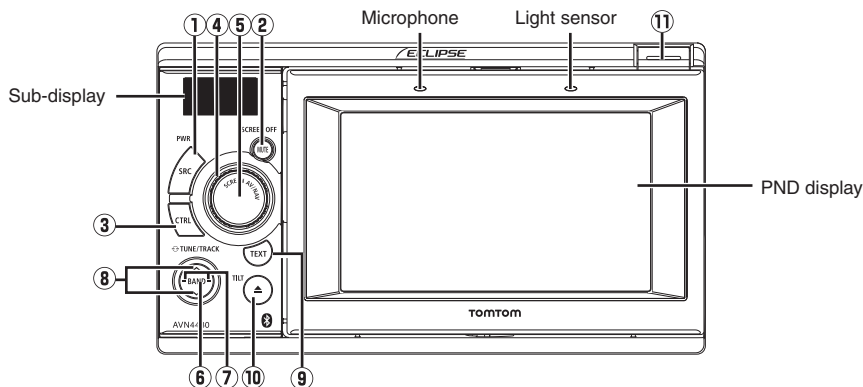

①	[SRC] button	Short press: Switches SOURCE. Long press (more than one second): Turns the audio mode OFF. Long press (more than 5 seconds): Turns the power completely OFF.
②	[MUTE] button	Short press: Turns MUTE ON or OFF. Long press: Turns the PND display OFF.
③	[CTRL] button	Short press: Switches the audio controls. Long press: Switches to the Adjustment screen while in the video mode. You can switch to the setting mode when PND is connected and PWR switch is OFF.
④	[VOL] rotary knob	Adjusts volume.
⑤	[SCREEN AV/NAV] button	Short press: Switches between the NAVI screen and AV screen. Turns the PND display ON when it is OFF. Long press: Displays the CAMERA screen when a camera is connected.
⑥	[BAND] button	Changes the bands, or playback format between CD-DA and MP3 (WMA).
⑦	[SELECT (Right/Left)] button	Short press: Tunes radio stations, selects CD/MP3/WMA, iPod and USB tracks, or selects DVD chapters. Long press: Tunes preset radio stations, selects CD/MP3/WMA, iPod and USB tracks, or fast forwards or rewinds a DVD.

About This Receiver

⑧	[SELECT (Upper/Lower)] button	Short press: Tunes radio stations by SEEK UP/DOWN. Selects folders in the CD (MP3/WMA) mode. Long press: Continues SEEK UP/DOWN of radio stations. Long press of the DOWN button: Returns to the root directory in the MP3/WMA mode.
⑨	[TEXT] button	Switches the title or display when the PND is installed. The current setting mode is displayed when the PND is removed.
⑩	[▲ (OPEN/EJECT)] button	Short press: Ejects the disc or opens and closes the front panel. Long press: Tilts the front panel step by step or forcibly ejects the disc when the front panel is open.
⑪	[Release] button	Removes the right side of the PND from the main unit.

Turning the POWER ON or OFF

When the power is turned on, the state used when the power was turned off such as CD and tuner playback is restored. When the vehicle has no ACC position on the ignition switch, care is needed when turning off the main unit. Follow Step 2 or Step 3 when turning off the power.

⚠ WARNING

- When the main unit's power is turned on for the first time or if the battery terminals have been disconnected, e.g. for vehicle maintenance, and the power is then turned back on, the main unit will start up in the FM mode. After this, the broadcast stations will be searched for automatically (ASM - Automatic Search Mode) and registered to preset numbers [1] to [6].
- If the "ACC" position is not provided in your vehicle, long press the [SRC] button to turn off the power completely.

⚠ IMPORTANT

When the audio source is turned off, the navigation screen is displayed continuously as long as it is selected.

1 When the power is OFF, press [SRC].

- The power will come ON.

2 When the power is ON, hold down the [SRC] button for 1 or more seconds.

- All audio sources will be turned OFF.

3 When the power is ON, hold down the [SRC] button for 5 or more seconds.

- The power will go completely OFF.

Switching Between the Audio and Navigation Screen

1 Each time you press the [SCREEN AV/NAV] button, the display switches between the AUDIO and NAVIGATION screens.



Turning the PND Display ON and OFF

1 When the PND display is ON, hold down the [MUTE] button for 1 or more seconds.

- The PND display will go OFF.

2 When the PND display is OFF, press the [SCREEN AV/NAV] button.

- The PND display will come ON.

Detaching the PND

■ Using the PND

The navigation function can also be used even if the PND is detached from the main unit.

ATTENTION

For details on using PND, refer to the operation manual of the PND.

■ How to Detach the PND from the Main Unit

IMPORTANT

- When detaching the PND, take care NOT to touch its rear side.
- After detaching the PND, mount the connector cover to the PND rear side.
- Take care not to attach the PND to this receiver without removing the connector cover from the rear side.
- When attaching the PND, do not press the monitor display.
- If the PND gets wet, do not attach it to the main unit.

1 Press the [Release] button.

- The right-hand side of PND will be unlatched from this receiver.

2 Remove the PND.

- Hold the PND on the right side, lift up and pull it toward you to remove it.

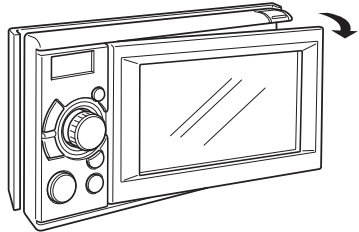

■ Attaching the PND

1 Latch the left-hand side of PND to this receiver.

- Engage the catch at the left end of the PND with the lock on the main unit.

2 Attach the PND to this receiver.

- Press the right-hand side of PND until it clicks in position.

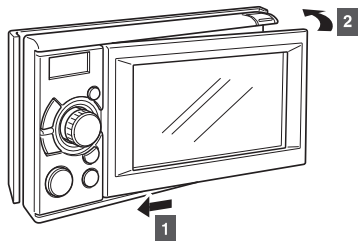

About This Receiver

Using the Audio Cover

■ Using the Audio Cover

After detaching the PND, we recommend you to use the optional Audio Cover for this receiver.

■ Fitting the Audio Cover

1 Mount the left end of audio cover on this receiver.

- Engage the catch at the left end of the Audio Cover with the lock on the main unit.

2 Mount the entire Audio Cover on this receiver.

- Press the right-hand side of Audio Cover so that it fits and clicks.

■ How to Detach the Audio Cover from the Main Unit

1 Press the [Release] button.

- This removes the right edge of the audio cover from the main unit.

2 Remove the audio cover.

- Hold the audio cover on the right side, lift it up and pull it toward you to remove it.

Hands-Free Microphone and Light Sensor

The PND is equipped with a built-in hands-free microphone and a light sensor. For details on how to use the hands-free call function or configure light sensor settings, refer to the operation manual of the PND.

⚠ IMPORTANT

- Pressing a sharp object against the hands-free microphone or the light sensor may damage them.
- If you are hard to hear the voice during hands-free calling, adjust the front panel tilting angle and try to direct the microphone toward you.

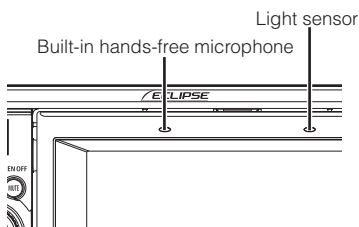

Adjusting the Display Angle

When the screen shines due to ambient sunlight, you can adjust the angle of the display.

CAUTION

When adjusting its angle, take care not to pinch your fingers. Otherwise you may hurt yourself or the display may fail.

IMPORTANT

- Do not mount a disc when the display is tilted. Otherwise the disc or this receiver will be scratched and damaged.
- When adjusting the display angle, use the following notes.

Automatic transmission (AT) car:

Adjust the display angle not to limit the driver to shift the AT lever to the "P", "Ⓜ", or "N" position. (If the lever shift is interfered with, do not tilt the display.)

Manual transmission (MT) car:

Adjust the display angle not to limit the driver to shift the MT lever to the "1", "3", "5", or "Ⓜ" position. (If the lever shift is interfered with, do not tilt the display.)

- 1 Hold down the [ (OPEN/EJECT)] button for 1 or more seconds.

- You can change the tilt angle in one step each time you press the button.
- The angle can be changed in 5°, and can be tilted up to 30°.

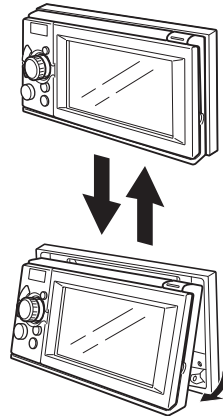

ATTENTION

- You can open the display even when it is tilted. When you close the display, it returns to the preset angle.
- If you tilt the display and turn the ignition key OFF, the display will return to the upright position. However, when you turn the ignition key to the ACC or ON position, the display returns to the preset angle.

About This Receiver

Loading/Unloading a Disc

When you listen to a music, insert a CD into the drive slot. Also, when you play a movie, insert its DVD into the slot.

■ Loading Steps

⚠ CAUTION

- You may not be able to open or close the display when the gearshift lever is set to P in an automatic transmission car; 1/3/5 or R in a manual transmission car; or a bottle or a similar object is placed in the cup holder. To open or close the display safely, set the gearshift lever to N (automatic transmission car) or to the Neutral position (manual transmission car) in advance, or empty the cup holder. Make sure that the car is not in motion by applying the parking brake and appropriately stepping on the foot brake in order to prevent damage or injury.
- Do not place a cup or can on the display while the display is opened. Doing so may damage the display.
- Do not press the [▲] (OPEN/EJECT) button while inserting a disc into the slot.

⚠ IMPORTANT

This receiver can play 8cm CDs and 8cm DVDs. To avoid disc problems, insert a disc without using an adapter.

1 Press the [▲] (OPEN/EJECT) button.

- The display will open and the disc insertion slot will open.

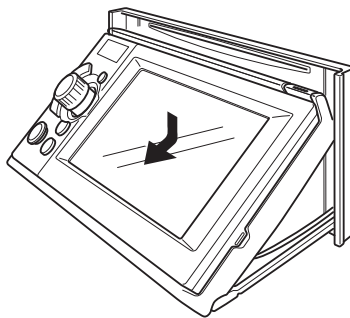

2 Insert a disc into the slot.

- The display will close automatically when the disc is inserted.
- Hold a DVD or CD correctly (by inserting your finger in its center hole and by holding the disc edge by another finger), face the disc label side upward, and insert the disc into the slot.
- When you insert a DVD into slot, its movie will be played in the DVD mode.

- When you insert a CD into slot, its music will be played or the MP3/WMA play will start.

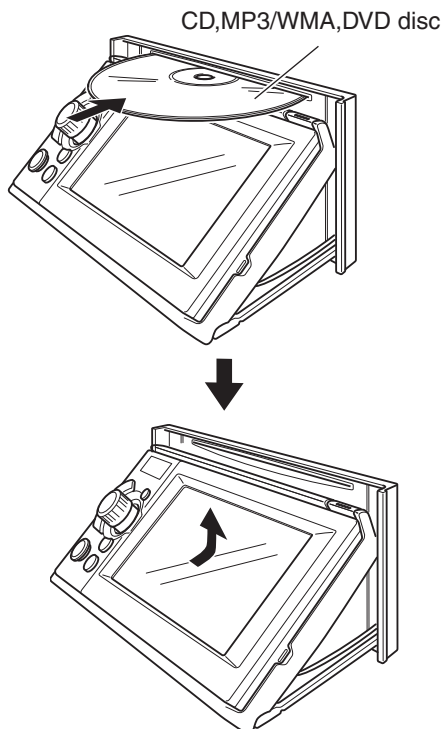

■ CD/DVD unloading steps

▲ IMPORTANT

- When unloading a disc, use the following notes.

Automatic transmission (AT) car:

If it is difficult to unload disc when the shift lever is in P position, shift it to the N position. (If your car has a column shift lever, shift it to the P or N position.)

Manual transmission (MT) car:

If it is difficult to unload disc when the shift lever is in "1", "3", "5" or "Ⓜ" position, shift it to the Neutral position.

- Take care NOT to close the display when the ejected disc remains in the slot. If this caution is not observed, this receiver or the disc may be scratched.
- Do not push and close the display by hand, or the display will be damaged.
- Wipe and clean the display immediately if juice or another type of liquid spills onto it. If it is not cleaned, the display may be damaged.
- To protect the display from heat and dusts, keep the display closed except when you load or unload a disc.
- If the disc does not eject (for example, if it is jammed), hold down the [▲ (OPEN/EJECT)] button for more than 5 seconds.

1 Press the [▲ (OPEN/EJECT)] button.

- This opens the display and ejects the disc.

2 After the disc has been ejected, press the [▲ (OPEN/EJECT)] button.

About This Receiver

Operation Conditions of this Receiver

You can or cannot operate this receiver in the following conditions (the ignition key positions).

CAUTION

When installing this device to vehicles, please be sure to connect the parking brake signal. If the parking brake signal is not connected, this device will not operate normally.

○: Operable; ×: Inoperable

	Engine switch			
	OFF (LOCK)	ACC/ON With parking brake set	ACC/ON With parking brake released	Display opened
Audio function	×	○	Some functions are inoperable for safety reasons.	× Voice guidance continues.
Video function	×	○	For your safety, only voice guidance and music play are active.*	× Voice guidance continues.

* DVD, iPod-video, and VTR images are NOT displayed during driving.

Setup of This Receiver

Setup of This Receiver

You can select the guide tone, illumination and other useful functions of this receiver.

Main Unit Settings

1 Hold down the [SRC] button for 1 or more seconds to turn the audio mode OFF.

2 Press the [SCREEN AV/NAV] button to call the Audio screen.

3 Hold down the [CTRL] button for 1 or more seconds.

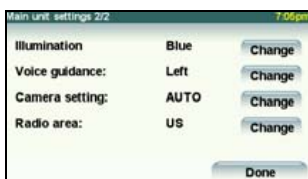

■ Enable guide tone

Turn the “Guide tone” ON or OFF. If turned ON, a guidance tone can be heard when you operate a button.

1 Touch **Enable guide tone** .

● It turns ON and OFF each time you touch **Enable guide tone** .

2 Touch **Next**.

3 Touch **Done**.

ATTENTION

The guide tone will only be output when the audio (other than that of an iPod/USB) is operated.

■ Enable AUX

Turn the “AUX setting” ON or OFF. If it is ON, you can select the AUX input.

1 Touch **Enable AUX** .

● It turns ON and OFF each time you touch **Enable AUX** .

2 Touch **Next**.

3 Touch **Done**.

Setup of This Receiver

■ Enable VTR

Turn the VTR ON or OFF. If it is ON, you can select the VTR input.

1 Touch **Enable VTR** .

- It turns ON and OFF each time you touch **Enable VTR** .

2 Touch **Next**.

3 Touch **Done**.

■ Dim sub-display

If “Enabled”, the sub-display brightness changes when you turn the car lights (side marker light, tail light, and license plate light) ON.

1 Touch **Dim sub-display** .

- It turns ON and OFF each time you touch **Dim sub-display** .

2 Touch **Next**.

3 Touch **Done**.

■ Link night view to headlights

If “Enabled”, the PND display is switched to the night view mode when you turn on the car lighting.

1 Touch **Link night view to headlight** .

- It turns ON and OFF each time you touch **Link night view to headlight** .

2 Touch **Next**.

3 Touch **Done**.

■ Illumination

The illumination colors can be switched.

1 Touch **Next**.

2 Touch **Change**.

- The illumination color is switched between Blue and Red each time you touch **Change**.

3 Touch **Done**.

■ Voice guidance

Select the Right or Left navigation voice channel.

1 Touch **Next**.

2 Touch **Change**.

- The Right and Left navigation voice channels are switched each time you touch **Change**.

3 Touch **Done**.

■ Camera setting

Set the camera to the AUTO or MANUAL operation mode.

In the AUTO mode, camera view is displayed on the PND when you shift the lever to reverse position or when you long press the [SCREEN AV/NAV] button. In the manual mode, camera view is displayed when you long press the [SCREEN AV/NAV] button.

1 Touch **Next**.

2 Touch **Change**.

- The AUTO and MANUAL operations are switched each time you touch **Change**.

3 Touch **Done**.

■ Radio area

Select US, Latin or Asia as your radio area. This function switches only the settings of the main unit. The PND map remains unchanged.

CAUTION

Be sure to select your radio area.

1 Touch **Next**.

2 Touch **Change**.

- The US, Latin, and Asia radio areas are switched each time you touch **Change**.

3 Touch **Done**.

Screen Adjustment and Setting

When you have stopped the car, you can switch from DVD, VTR, or iPod-video image to the Adjustment screen and you can adjust the display contrast and brightness.

Setup of This Receiver

Picture Quality Adjustment

- 1 Hold down the [CTRL] button during DVD or VTR image display.





■ Contrast

- 1 Adjust the contract of image by sliding  from the left end position (0%) to the right end position (100%).



■ Brightness

- 1 Adjust the brightness of image by sliding  from the left end position (0%) to the right end position (100%).

■ Color

- 1 Touch .
- 2 Adjust the color of image by sliding  from the left end position (0%) to the right end position (100%).

■ Tint (only for NTSC)

- 1 Touch .
- 2 Adjust the tint of image by sliding  from the left end position (0%) to the right end position (100%).

ATTENTION

If no adjustments are made for 6 seconds, the image quality adjustment screen will be canceled.

Switching the Wide Screen Mode

CHECK

You can switch the screen mode from DVD, iPod-video, or VTR setting screen.

1 Touch **16:9**, **4:3** or **Zoom**.

- You can display the switch as follows.

DVD:

Touch **Next** on the operation screen, and touch **Display**.

iPod-video/VTR:

Touch **Display** on the operation screen.



- 4:3 mode

The screen is shown with the 3 (vertical) by 4 (horizontal) aspect ratio (normal TV screen size) and side edges are black.



- 16:9 mode

The screen with the 9 (vertical) by 16 (horizontal) aspect ratio (normal TV screen size) is uniformly expanded in the left and right directions.



- Zoom mode

The screen with the 3 (vertical) by 4 (horizontal) aspect ratio (normal TV screen size) is uniformly expanded in the up, down, left and right directions.

ATTENTION

The user should not experience any problems when watching a video on the wide screen on a personal basis. If you compress or enlarge the screen for commercial purposes or to display to the public, it may infringe a copyright that is protected by copyright laws.

Switching the Audio Source

Switching the audio source

1 Press the [SRC] button.

- The audio source is switched as follows each time you press the [SRC] button.

FM/AM → Sirius^{*1} → XM^{*1} → DISC (DVD or CD)^{*2} → USB^{*1*4} → AUX^{*3} → iPod^{*1*4} → VTR^{*5} → FM/AM → ...

- *1 Cannot be selected if the corresponding device is not connected to the main unit.
- *2 You cannot select it if no disc is loaded.
- *3 Cannot be selected if the AUX setting is set to OFF
- *4 If the PND is not connected to the main unit, you cannot select the USB mode or iPod mode.
- *5 Cannot be selected when the VTR setting is set to OFF.
- *6 North American models only

Volume Control

Adjusting the volume

1 Turn the [VOL] rotary knob.

- Turn to the right to increase the volume.
Turn to the left to decrease the volume.

ATTENTION

- Adjust the volume level that does not affect on your safety driving.
- You can control the volume level from 0 to 80.
- The actual sound level may vary when you have switched the audio source. Adjust the sound level appropriately according to the audio source you select. For volume control, see "Adjusting the SVC (Source Volume Control)" on page 33.

Muting the Volume

1 Press the [MUTE] button.

- The sound is muted.
- Press the [MUTE] button again to return to the previous sound level.
- To cancel muting, just increase the volume. The volume will increase (for the steps you selected) from the previous level before muting.
- The navigation voice guidance can be heard even when you have muted the audio system.

Adjusting the sound quality

You can fine-tune the audio sound in the audio control mode.

Switching Audio Control Modes

⚠ IMPORTANT

- The audio control mode is canceled if you press no button more than 6 seconds.
- You can check your settings on the PND screen when it is attached. When detached, you can check the settings on the sub-display.

1 The Audio Control mode is switched in the following sequence each time you press the [CTRL] button.

BASS → MID → TREB → BAL → FAD → NON-F → NF-P → LPF → LOUD → SVC ...

2 You can adjust the level in each mode by rotating the [VOL] knob.

■ Adjusting the BASS

You can adjust the bass (low sounds).

- To the right:
Emphasizes low sounds.
- To the left:
Softens low sounds.

■ Adjusting the MIDDLE

You can adjust the mid-range sounds.

- To the right:
Emphasizes mid range sounds.
- To the left:
Softens mid range sounds.

■ Adjusting the TREBLE

You can adjust the treble (high sounds).

- To the right:
Emphasizes high sounds.
- To the left:
Softens high sounds.

■ Balancing the Right and Left Speakers (BALANCE)

You can adjust the balance of right and left speakers.

- To the right:
Emphasizes right speakers.
- To the left:
Emphasizes left speakers.

■ Balancing the Front and Rear Speakers (FADER)

You can adjust the balance (fading) of front and rear speakers.

- To the right:
Emphasizes front speakers.
- To the left:
Emphasizes rear speakers.

■ Adjusting non-fader level (NON-FADER LEVEL)

Non-fader level (for connected sub-woofer) can be adjusted.

- To the right:
Increases the sub-woofer level.
- To the left:
Decreases the sub-woofer level.

■ Selecting phase (NON-FADER PHASE)

The merger of sound between the front and rear speakers and the woofer can be improved by selecting the phase. Switch the phase which lets the speakers combine without any disharmony.

- To the right:

NORMAL

Make the output timing of the front/rear speakers and the woofer the same.

To the left:

REVERSE

Change the phase of the output timing of the front/rear speakers and the woofer.

■ Adjusting frequency filtering settings (Low Pass Filter for Sub-Woofers output)

Frequency filtering settings can be adjusted.

- To the right:

LPF ON

Only allow lower frequencies (low range) through.

To the left:

LPF OFF

Allow all frequencies through regardless if the frequencies are low or high.

■ Setting the loudness mode (LOUDNESS)

Accentuate low and high frequencies when the volume is low.

When loudness is ON, the apparent deficiency in the high sounds is compensated for.

- To the right:

Turns ON.

To the left:

Turns OFF.

■ Adjusting the SVC (Source Volume Control)

In this mode you can set the volume level for each audio source, taking the FM radio volume level as the reference level.

(The volume level of the audio source you are currently listening to is adjusted.)

IMPORTANT

If the DVD sound level is too low, adjust the SVC for it.

- To the right:

Increases the sound level of current audio source.

To the left:

Decreases the sound level of current audio source.

Using the Radio

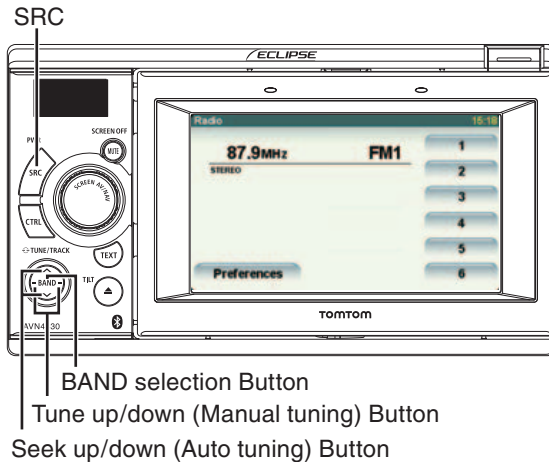

Listening to the Radio

- 1 Press the [SRC] button repeatedly until “FM” or “AM” is displayed on the sub-display.

Tune a Desired Station.

CAUTION

If the vehicle's battery is disconnected (for repairs to the vehicle or for removing the main unit), all stations in memory will be lost. In such a case, set stations in memory again.

IMPORTANT

At times, it may be difficult to maintain optimum reception because the antenna affixed to your vehicle is in motion constantly (relative to the broadcast antenna), encountering continuous variation in the strength of received radio signals. Other factors affecting reception include interference from natural obstacles, sign posts, etc.

Manual Tuning

- 1 Press the [SELECT (Right)] or [SELECT (Left)] button.

- To the right:
Tunes up for one step.
- To the left:
Tunes down for one step.

Auto Tuning

- 1 Press the [SELECT (Up)] or [SELECT (Down)] button.
- When a station having the frequency closest to the one shown on the screen is tuned, the auto tuning stops. To cancel auto tuning, press the button again.

ATTENTION

Auto tuning may fail if the received signal is weak.

■ Selecting a Preset Channel

1 Hold down the [SELECT (Right)] or [SELECT (Left)] button for 1 or more seconds.

- To the right:
Switches to the next larger preset channel.
- To the left:
Switches to the next smaller preset channel.

■ Touching a Preset Switch

1 Touch a preset switch of memory.



- The registered preset channel will be selected and the corresponding station will be received.

Selecting a Radio Band

1 Press the [BAND] button.

- The receiver band is switched as follows each time you press the [BAND] button.
FM1 → FM2 → FM3 → AM → FM1 → ...

Saving a Station in Memory

You can save a radio station in memory in the auto or manual mode.

■ Manual Saving

1 Select a station you wish to save by Manual tuning or Auto tuning.

2 Touch the preset switch of station you wish to save until a beep sounds.



- The selected station will be saved, and the preset channel number and frequency will be shown on the display.

To manually set additional selected stations for the remaining preset channels, repeat this procedure for each channel.

Six stations can be memorized for each of FM 1, 2 and 3, and six stations can be memorized for AM, making a total of 24 stations.

If the stations have been stored in memory, a station can be selected by touching a preset switch and the station can be received.

Using the Radio

Auto Station Memory (ASM)

IMPORTANT

- You can select a station by simply touching a preset switch (any of [1] to [6]). The frequency of the selected station is displayed.
- When you save a new station in memory, the existing station is cleared instead.
- If you can tune less than six stations, the remaining stations are kept in memory.

1 Touch **Preferences**.



2 Touch **ASM**.



- The automatic station selection will start with a beep sound. A search will be conducted from the lowest frequency through progressively higher frequencies and stations with strong reception will be memorized for preset registration numbers [1] to [6]. The registration procedure has been completed, a beep sounds twice and the station memorized last (i.e. the one memorized for P6) will continue to be received. Subsequently, when you listen to the radio you will be able to select stations by calling up preset numbers.

To stop ASM, touch **Stop ASM**.

Preset Scan

This function enables reception of all the stations in the preset switches to be played for five seconds each.

1 Touch **Preferences**.

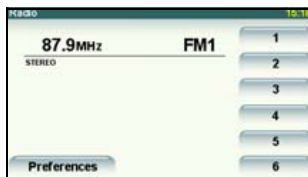

2 Touch **Preset SCAN**.



- The stations of preset switches P1 to P6 will be scanned sequentially. Each station is turned for five seconds.

To cancel the preset scan, touch **Stop SCAN**.

Showing the current frequency on the sub-display

The frequency can be displayed on the LCD when the PND is connected.

1 Press the [TEXT] button.

How to use the SIRIUS satellite radio

When an optional SIRIUS satellite radio tuner is connected, SIRIUS satellite radio broadcasts can be received.

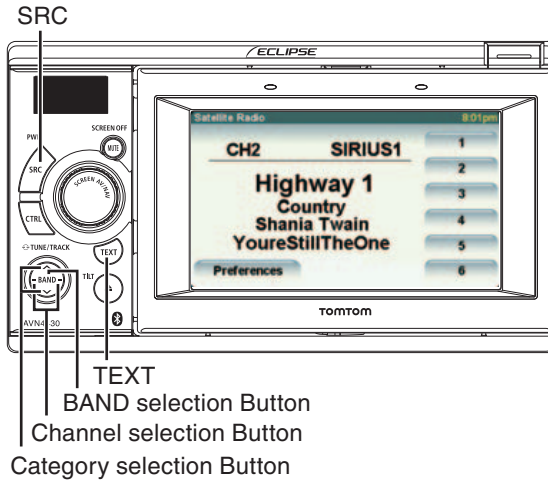

Listening to SIRIUS satellite radio

With SIRIUS satellite radio, over 100 channels are available including music, news, and entertainment programs.

You can select the channel you want from various categories such as POP and ROCK, or you can select a channel by direct input.

Reception of SIRIUS satellite radio is a paid subscription.

- 1 Press the [SRC] button repeatedly until "SIR" is displayed on the sub-display.

Check the SIRIUS ID

The SIRIUS ID number is a 12-digit numerical code that is assigned each time the SIRIUS satellite radio tuner is connected.

- 1 Touch **Preferences**.

- A 12-digit numerical code is displayed.
- You can also check the SIRIUS ID by selecting CH0.



How to use the SIRIUS satellite radio

Changing the SIRIUS band

1 Press the [BAND] button.

- The BAND changes.

[SR1] → [SR2] → [SR3] → [SR4] ... → return to [SR1]

Selecting the channel you want to listen to

■ Searching the channel upward or downward within the selected category

1 Press the [SELECT (Up)] or [SELECT (Down)] button.

- Up: Searches the channel upward within the selected category.
- Down: Searches the channel downward within the selected category.

■ Selecting a category

1 Press the [SELECT (Up)] or [SELECT (Down)] button for 1 or more seconds.

- Up: Advances to the next category.
- Down: Returns to the previous category.

■ Selecting a channel

1 Press the [SELECT (Right)] or [SELECT (Left)] button.

- Right: Selects the higher channel.
- Left: Selects the lower channel.

2 Press the [SELECT (Right)] or [SELECT (Left)] button for 1 or more seconds.

- Right: Selects the next preset channel.
- Left: Selects the previous preset channel.

■ Selecting a channel by direct input

1 Touch **Preferences**.



2 Touch **Direct CH selection**.



- 3 Input a channel.



- 4 Touch **Select**.

Memorizing Channels

IMPORTANT

If the vehicle's battery is disconnected (for repairs to the vehicle or for removing the main unit), all channels in memory will be lost. In such a case, set channels in memory again.

- 1 Tune into the station to be memorized.

- 2 Touch the preset switch where you want to memorize the station until you hear a beep sound.

- The selected station will be memorized.

To set additional manually selected stations for the remaining preset channels, repeat this procedure for each preset channel.

Subsequently, when listening to the satellite radio you will be able to tune into stations by touching the preset switch.



Selecting a preset channel

- 1 Touch one of the touch switches, [1] to [6], that appear on the PND display.

- The channel preset to the selected touch switch is tuned.

Preset Scan

- 1 Touch **Preferences**.

- 2 Touch **Preset SCAN**.

- "SCAN" will be displayed and the stations memorized for preset channels P1 to P6 will be called up in order and received for five seconds each.

To cancel the preset scan, touch **Stop SCAN**.

Displaying information about the current broadcast on the sub-display

When receiving a SIRIUS broadcast, information about the current broadcast, such as the channel, category, track title, artist, and channel number, can be displayed with the PND disconnected.

- 1 Press the [TEXT] button.

- The channel number is shown on the sub-display.

How to use the XM satellite radio

When an optional XM satellite radio tuner is connected, XM satellite radio broadcasts can be received.

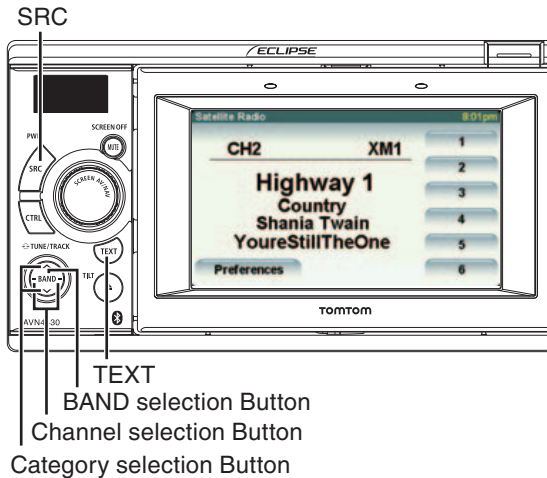

Listening to XM satellite radio

With XM satellite radio, over 100 channels are available including music, news, and entertainment programs.

You can select the channel you want from various categories such as DANCE and ROCK, or you can select a channel by direct input.

Reception of XM satellite radio is a paid subscription.

- 1 Press the [SRC] button repeatedly until "XM" is displayed on the sub-display.

Checking the RADIO ID

The RADIO ID number is a 8-digit numerical code that is assigned each time the XM satellite radio tuner is connected.

- 1 Touch **Preferences**.

- An 8-digit numerical code is displayed.
- You can also check the RADIO ID by selecting CH0.



Changing the XM band

1 Press the [BAND] button.

- The BAND changes.

[XM1] → [XM2] → [XM3] → [XM4] ... → return to [XM1]

Selecting the channel you want to listen to

■ Searching the channel upward or downward within the selected category

1 Press the [SELECT (Up)] or [SELECT (Down)] button.

- Up: Searches the channel upward within the selected category.
Down: Searches the channel downward within the selected category.

■ Selecting a category

1 Press the [SELECT (Up)] or [SELECT (Down)] button for 1 or more seconds.

- Up: Advances to the next category.
Down: Returns to the previous category.

■ Selecting a channel

1 Press the [SELECT (Right)] or [SELECT (Left)] button.

- Right: Selects the higher channel.
Left: Selects the lower channel.

2 Press the [SELECT (Right)] or [SELECT (Left)] button for 1 or more seconds.

- Searches the channel in the category currently selected.
Right: Selects the next preset channel.
Left: Selects the previous preset channel.

■ Selecting a channel by direct input

1 Touch **Preferences**.



2 Touch **Direct CH selection**.



How to use the XM satellite radio

- 3** Input a channel.



- 4** Touch **Select**.

Memorizing Channels

IMPORTANT

If the vehicle's battery is disconnected (for repairs to the vehicle or for removing the main unit), all channels in memory will be lost. In such a case, set channels in memory again.

- 1** Tune into the station to be memorized.

- 2** Touch the preset switch where you want to memorize the station until you hear a beep sound.

- The selected station will be memorized. To set additional manually selected stations for the remaining preset channels, repeat this procedure for each preset channel.

Subsequently, when listening to the satellite radio you will be able to tune into stations by touching the preset switch.



Selecting a preset channel

- 1** Touch one of the touch switches, [1] to [6], that appear on the PND display.

- The channel preset to the selected touch switch is tuned.

Preset Scan

- 1** Touch **Preferences**.

- 2** Touch **Preset SCAN**.

- "SCAN" will be displayed and the stations memorized for preset channels P1 to P6 will be called up in order and received for five seconds each. To cancel the preset scan, touch **Stop SCAN**.

Displaying information about the current broadcast on the sub-display

When receiving an XM broadcast, information about the current broadcast, such as the channel number, channel, artist, feature, song, and program title, can be displayed with the PND disconnected.

- 1** Press the [TEXT] button.

- Information on the music being played will be shown on the sub-display and switched as follows.

channel No. → channel name → artist/feature → song/program title → channel No. → ...

Using the CD Player

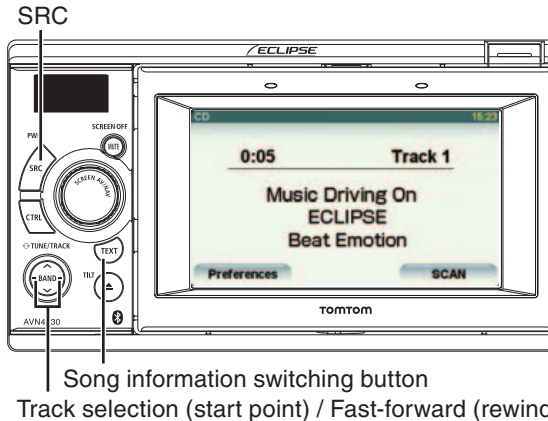

Song information switching button
Track selection (start point) / Fast-forward (rewind) button

Listening To a CD

Insert a CD into the disc slot, and it will start playing.

CAUTION

- Do not press the [▲] (OPEN/EJECT) button when you are inserting a CD into disc slot. This may cause a personal injury and damage to the front panel.
- Do not drive your car while the front panel of this receiver is kept open. The panel may cause unexpected personal injury in the case of a sudden stop or similar event.
- Do not attempt to close the front panel by hand. Doing so may damage the panel.

IMPORTANT

Playback may be intermittent when there is a scratch on a CD or when the recorded side is dirty.

- 1 Press the [SRC] button repeatedly until "CD" is displayed on the sub-display.

- The disc starts to play.

ATTENTION

- If track titles and other data are recorded in the CD-Text format, you can display them.
- Note that the CD-Text of a CD-R/RW disc may not be displayed.

Selecting a Desired Track

You can cue a desired track.

- 1 Press the [SELECT (Right)] or [SELECT (Left)] button.

- Right: Advances to the next track.
Left (pressing once): Returns to the beginning of the track being played.
Left (pressing more than two times): Returns to the previous track.

Using the CD Player

Fast Forward/Rewind

You can fast forward or rewind the track currently being played.

- 1 Hold down the [SELECT (Right)] or [SELECT (Left)] button for 1 or more seconds.

- To the right:
Fast forwards a track.
- To the left:
Rewinds a track.

When a beep sounds, the fast forward (or rewind) mode starts and the song is fast forwarded (or rewound) until you remove your finger from the switch.

Finding a Desired Title

- 1 Touch **SCAN**.



- The main unit will play the first 10 seconds of each track. When you touch **Stop SCAN**, the current track is continued to play.

Repeating the Same Track

- 1 Touch **Preferences**.



- 2 Touch **Repeat song** .

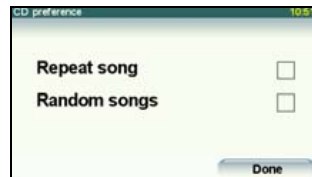

- The track repeats to play.
- When you touch **Repeat song** , the track repeats to play until you cancel it. Touch **Repeat song** again to cancel the repeat play.

Random Play

- 1 Touch **Preferences**.



- 2 Touch **Random songs** .

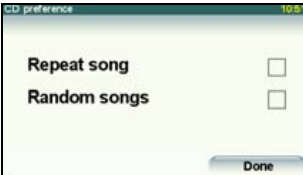

- All titles of the CD are played in random order.
- When you touch **Random songs** , the random play continues until you cancel it. When you touch **Random songs** , again, the random play is canceled.

Displaying the information on the sub-display

The current track number and the elapsed time can be shown on the sub-display.

- 1 Press the [TEXT] button.

- The display changes as follows each time you press the [TEXT] button.
Track No. → Elapsed time → Track No. →
...

Using the MP3/WMA Player

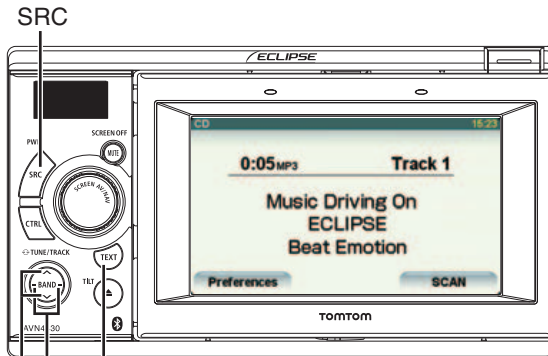

- Song information switching button
- Track selection (start point) /
- Fast-forward (rewind) / File selection button
- Folder selection Button

Playing an MP3/WMA File

When you insert a CD-R/RW disc having an MP3/WMA file into disc slot, the file is played.

CAUTION

- Do not press the [▲] (OPEN/EJECT) button when you are inserting a CD into disc slot. This may cause a personal injury and damage to the front panel.
- Do not drive your car while the front panel of this receiver is kept open. The panel may cause unexpected personal injury in the case of a sudden stop or similar event.
- Do not attempt to close the front panel by hand. Doing so may damage the panel.
- If a non-MP3/WMA file has the “.mp3” or “.wma” file extension, it may be recognized erroneously as an MP3/WMA file. When such file is played, the very large noise is output and speakers may be damaged. Take care not to assign the “.mp3” and “.wma” extensions to non-MP3/WMA files.

IMPORTANT

- Playback may be intermittent when there is a scratch on a CD or when the recorded side is dirty.
- The CD-ROM supports a folder or file selection function.

1 Press the [SRC] button repeatedly until “ROM” is displayed while a CD-R/ RW disc is in the drive slot.

- The disc starts to play.
- The files are usually played in the following sequence: [1] → [2] → [3] → [4] → [5] → [6] → “[A configuration example of MP3/WMA supported CD]” on page 53.
- If multiple MP3/WMA files and folders locates in the same hierarchy, they are played in the ascending order of file and folder names.
- If you try to create a non-MP3/WMA format file, “NO SUPPORT” warning is displayed.

Selecting a Desired Folder

You can select a desired folder from the disc.

1 Press the [SELECT (Up)] or [SELECT (Down)] button.

- Up: Goes to the next higher folder and plays the first track of this folder.
Down: Goes to the next lower folder and plays the first track of this folder.

Selecting a Desired Music File

You can select a desired music file from the folder.

IMPORTANT

If music data (CD-DA) and MP3/WMA data are mixed on the same disc, you can switch the playback file format by pressing the [BAND] button.

1 Press the [SELECT (Right)] or [SELECT (Left)] button.

- Right: Advances to the next file.
Left (Press once.): Returns to the beginning of the playing file.
Left (Press twice or more.): Returns to previous files.

Fast Forward/Rewind

You can fast forward or rewind the currently playing track.

1 Hold down the [SELECT (Right)] or [SELECT (Left)] button for 1 or more seconds.

- To the right:
Fast forwards a track.
To the left:
Rewinds a track.

When a beep sounds, the fast forward (or rewind) mode starts and the track is fast forwarded (or rewound) until you remove your finger from the switch.

Returning To the Root Directly

You can return to the root directory and play its file.

IMPORTANT

If no file is found in the root directory, a file in the first folder is played.

1 Hold down the [SELECT (Down)] button for 1 or more seconds.

- You can return to the root directory and play its file.
- For an MP3/WMA file creation example, see “[A configuration example of MP3/WMA supported CD]” on page 53.

Using the MP3/WMA Player

Finding a Desired Music File

IMPORTANT

- To continue playing a desired track or file, turn the Scan function OFF.
- The entire disc is scanned once, and the normal play starts from the position where you started to scan.
- When you select "Playing the Start of Tracks/Files", "Repeated Playing", or "Playing the Tracks/Files in Random Order", its function is shown as "SCAN", "ALL", "RPT", or "RAND" on the display.

1 Touch **SCAN**.

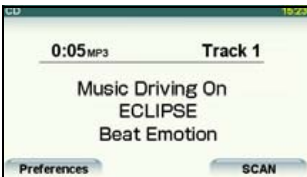

2 Touch **Current folder** or **First song of each folder** .

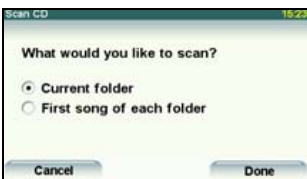

● Touch **Cancel** to return to the previous page.

● **Current folder**: Plays the first 10 seconds of each track contained in the same folder layer.

First song of each folder: Plays the first 10 seconds of track in each folder.

When you touch **Stop SCAN**, the current track is continued to play.

Repeating a Music File

IMPORTANT

When you select "Playing the Start of Tracks/Files", "Repeated Playing", or "Playing the Tracks/Files in Random Order", its function is shown as "SCAN", "ALL", "RPT", or "RAND" on the display.

1 Touch **Preferences**.

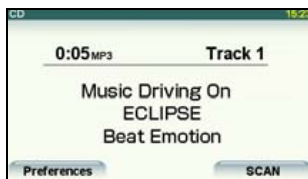

2 Touch **Repeat** .

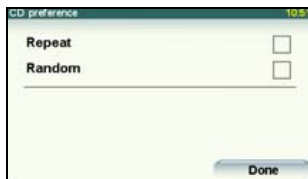

3 Touch **Current song** or **Current folder** .

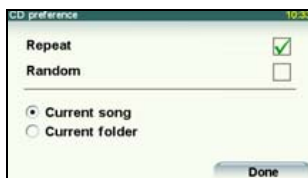

● **Current song**: Repeats the current file.

Current folder: Repeats files of the current folder.

● Touch **Repeat** again to cancel repeating.

Random Play

IMPORTANT

When you select "Playing the Start of Tracks/Files", "Repeated Playing", or "Playing the Tracks/Files in Random Order", its function is shown as "SCAN", "ALL", "RPT", or "RAND" on the display.

1 Touch **Preferences**.



2 Touch **Random**.



3 Touch **Current folder** or **All songs**.



- **Current folder:** Plays files in random order contained in the same layer of the current folder.

All songs: Plays files of all folders in random order.

When you touch **Random**, the random play continues until you cancel it. When you touch **Random** again, the random play is canceled.

If you touch **Repeat** during random play, the current track is repeated. When you touch **Repeat** again, random play restarts.

Using the MP3/WMA Player

Displaying the information on the sub-display

The current track number and the elapsed time can be shown on the sub-display.

1 Press the [TEXT] button.

- The display changes as follows each time you press the [TEXT] button.

File No. → Elapsed time → File No. → ...

Switching Between CD-DA and MP3/WMA

If a disc contains both sound data (CD-DA) and MP3/WMA music files, you can switch between them.

1 To play an MP3/WMA music file, press the [BAND] button.

- Press the [BAND] button again to play the CD-DA data.

MP3/WMA

MP3 (MPEG Audio Layer 3) is a standard format for audio compression technology. By using MP3, a file can be compressed to one-tenth the size of the original.

WMA (Windows Media™ Audio) is the Microsoft's voice compression technology. WMA files can be compressed to a size smaller than MP3 files.

This receiver accepts certain MP3/WMA file standards, recorded media and formats. Use the following notes when you write MP3/WMA files on a disc.

■ Playable MP3 File Standards

- Supported standards:
MPEG Audio Layer 3 (=MPEG1 Audio Layer III, MPEG2 Audio Layer III, MPEG2.5 Audio Layer III)
- Supported sampling frequencies:
8, 11.025, 12, 16, 22.05, 24, 32, 44.1, 48 (kHz)
- Supported bit rates:
8, 16, 24, 32, 40, 48, 56, 64, 80, 96, 112, 128, 144, 160, 192, 224, 256, 320 (K bps)
 - * Supports VBR.
 - * Does not support free format.
- Supported channel modes:
Stereo, Joint Stereo, Dual channels, Monaural

■ Playable WMA File Standards

- Supported standards:
WMA Ver. 9 Standard Decoder Class 3 satisfied
- Supported sampling frequencies:
22.05, 32, 44.1, 48 (kHz)
- Supported bit rates:
20, 22, 32, 36, 40, 44, 48, 64, 80, 96, 128, 160, 192, 256, 320 (K bps)
 - * The 2-channel play is only supported.
 - * Supports VBR. (5 to 320K bps)
 - * Does not support lossless compression.

Using the MP3/WMA Player

■ ID3/WMA Tags

You can store ID3/WMA tag character information such as track titles and artist names in an MP3 and a WMA file.

This receiver supports ID3v.1.0 and ID3v.1.1 tags. This receiver supports the ISO 8859-1 codes only. Use only the ISO-8859-1 codes to record tags. If characters not included in ISO-8859-1 codes are recorded, their display may be unreadable.

This receiver supports the WMA tag ASF revision (v1.20.02). WMA tags having only Unicode are supported. Always use Unicode characters to enter the information.

■ Supported Media Types

You can play MP3/WMA files recorded on a CD-ROM, CD-R or CD-RW disc. Compared to CD-ROM media commonly used for music discs, CD-R and CD-RW discs are fragile in high temperature/high humidity environments and one section of the CD-R/CD-RW may become incapable of playback. Fingerprints or scratches on the disc may prevent playback or cause skipping during playback.

Sections of CD-R/CD-RW may deteriorate if left inside a vehicle for long periods of time.

We recommend that you store UV-sensitive CD-R and CD-RW discs in shield cases.

■ Format of Discs

You can use the following format discs on the player.

- CD-ROM formats:

- CD-ROM Mode 1, CD-ROM XA Mode 2 (Form 1)

- File formats:

- ISO9660 Level 1 or Level 2

- ROMEO system, JOLIET system

MP3/WMA files recorded in a format other than the one explained above may result in files that cannot be played normally and in file names and folder names that do not display properly.

Limitations in addition to standards are as follows.

- Maximum directory layers:

- 8 layers

- Maximum characters for folder and file names:

- 30 characters (including delimiter "." and 3 characters of file extension) for MP3, but 15 characters (including delimiter "." and 3 characters of file extension) for WMA.

- Supported characters for folder and file names:

- A to Z, 0 to 9, and underscore (_)

- Number of files that can be stored on a single disc:
512 files
- Number of folders that can be stored on a single disc:
255 files

[A configuration example of MP3/WMA supported CD]

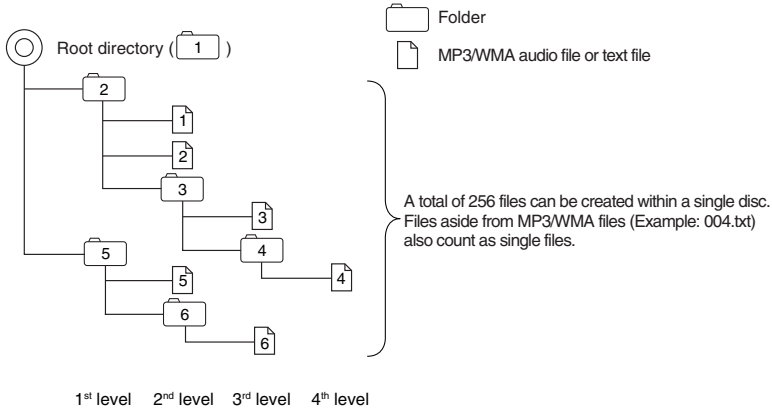

■ File Names

Only a file with the “mp3” or “wma” extension is recognized as an MP3 or WMA file. Always save an MP3/WMA file with the “mp3”/“wma” extension.

The “mp3” or “wma” file extension must be single-byte uppercase letters.

ATTENTION

If a non-MP3/WMA file has the “mp3” or “wma” file extension, it may be recognized erroneously as an MP3/WMA file. When such file is played, the very large noise is output and speakers may be damaged. Do not save a non-MP3/WMA file with the “mp3” or “wma” extension.

■ Multi-sessions

Multisessions are supported and CD-R/RW with recorded MP3/WMA files can be played. When written with “Track at once”, however, finalize the disc with session close or write protect.

Using the MP3/WMA Player

■ Playing MP3/WMA

When you load a disc with MP3/WMA files, the system first checks all files recorded on the disc. If the disc has many files and folders, the system may take a certain time to check them.

While the system is checking the disc, the music that had been playing continues to play.

To quickly check files, we recommend that you do not save non-MP3/WMA files and not to create unnecessary folders on the disc.

Also, we recommend you to write the entire data in a single session as the system takes a longer time to read the CD control information of a multi-session disc.

■ MP3/WMA Playing Time Display

It is possible that playing time will not be correct, depending on the writing condition of the MP3/WMA file.

* It is possible that playing time will not be correct when VBR Fast Up/Down is operated.

Creating and Playing MP3/WMA Files

The making of MP3/WMA files by recording from sources such as broadcasts, records, recordings, videos and live performances without permission from the copyright holder for uses other than personal enjoyment is prohibited.

■ Downloading From an MP3/WMA Music Site of Internet

You can find various types of MP3/WMA music distribution sites including online shopping, trial listening, and free downloading sites on the Internet. You can download music files from those sites by following their payment and other downloading rules.

■ Converting a Music CD into MP3/WMA Files

Prepare a PC and a market-available MP3/WMA encoder (conversion) software. (Some of them are free.) Load a music CD on the PC's CD-ROM drive and compress the music CD by following the procedure of MP3/WMA encoder software. MP3/WMA-format music data files are created. A 12cm music CD (having a maximum of 74 minutes of recording/650MB of data) can be compressed to 65MB (about 1/10 of the original size).

■ Writing MP3/WMA Files On a CD-R/RW Disc

MP3/WMA files can be recorded on CD-R/RW by using a CD-R/RW drive connected to a computer. Record by setting the recording format of the recording software to ISO9660 level 1 or level 2 (not including extension format).

Select CD-ROM (mode1) or CD-ROM XA (mode2) for the disc format.

■ When Playing Back CD-R/RW

Insert a CD-R/RW disc having recorded MP3/WMA files. When you load a disc, the system automatically determines whether it is a music CD or a CD-R/RW disc having MP3/WMA files and plays it correctly. However, depending on the type of disc being used, the disc may not play.

CAUTION

- The 128K bps fixed bit rate and 44.1-kHz sampling frequency are recommended to use to have a high quality of playback sound.
- Note that some CD-R and CD-RW discs may not be read due to their characteristics.
- Because there are many types of MP3/WMA encoding software available, including commercial and freeware programs, audio quality may deteriorate, noise may be generated when playing starts and some recordings may not play, depending on the condition of the encoder and the file format.
- When files other than MP3/WMA files are recorded on a disc, the system may take some time to recognize the disc and it may not play the disc.

Using the USB Music File Player

This receiver can play a music file stored in a USB memory. This receiver can play MP3 files only.

IMPORTANT

You can play a music file of USB memory only when the PND is attached to this receiver.



Track selection / Fast-forward (rewind) button

Playing USB Music Files

CAUTION

- Connect the USB cable correctly so that it does not interfere with your safe operation of vehicle.
- After connecting the USB memory (while a message “Don’t remove the storage device until scanning is finished” is displayed), do not turn off the power or remove the PND/USB memory. Before removing the USB memory, switch the display to the audio screen and touch



IMPORTANT

When a USB memory device is attached, the receiver may take a time to scan and read the file tag information. To shorten this scan time, try to store only MP3 files in the USB memory and to reduce the number of folders in the USB memory.

- 1 Connect the USB memory to the USB connector.

- 2 Press the [SRC] button repeatedly until “USB” is displayed on the sub-display.

- Playback will begin.

Fast Forward/Rewind

It is possible to fast forward/rewind the track currently being played.

- 1 Hold down the [SELECT (Right)] or [SELECT (Left)] button for 1 or more seconds.

- To the right:
Fast forwards a track.

To the left:

Rewinds a track.

This switches to the fast forward or rewind mode, and continues fast forwarding or rewinding until you remove your finger from the button.

Selecting a Desired Music File

You can select a track you want to play.

1 Press the [SELECT (Right)] or [SELECT (Left)] button.

- To the right:
Advances to the next file.
- To the left:
Returns to the previous file.
- The selected track (file) will be played.

Finding a Desired Music File

CAUTION

- Despite a CD-ROM disc, a folder selection by audio buttons is not supported in the USB mode.
- Before disconnecting the USB memory from this receiver, always switch the display to the audio mode screen and touch . Loss of data may result if this procedure is not followed.
- If you disconnect the USB memory or the PND from this receiver when a music file of USB memory is being played, the receiver returns to the previous operation mode.
- You cannot operate the , , and **Find** buttons when your car is running.

1 Touch **Select**.



2 To select a track to play, touch **Playlist**, **Artist**, **Album**, **Song**, or **Genre**.

- This displays the list screen of the selected mode.



3 Touch the name of the music file to be played.

- This plays the selected music file.
- When or appears, touch them to change the page of the music file list.
- You can search for a file or artist name by touching **Find**.

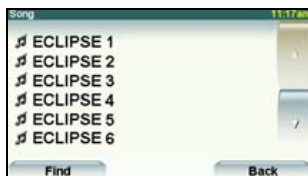

- You can search for a music file by entering alphanumeric characters.

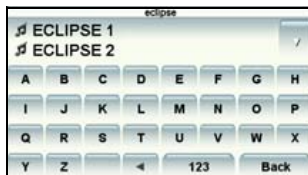

Using the USB Music File Player

Repeatedly Playing the Same Music File

1 Touch **Preferences**.

2 Touch **Repeat song** .

- This repeatedly plays the currently played music file.
- Once you touch **Repeat song** , the selected music file will be repeated until the repeat function is released. Touch **Repeat song** again to cancel the repeat play.

Random Play of Music Files

1 Touch **Preferences**.

2 Touch **Shuffle songs** .

- Once you touch **Shuffle songs** , the random play continues until you cancel it. Touch **Shuffle songs** again to cancel the random play.

About USB devices

■ Playable USB Memory Standards

- Supported USB devices:
Max storage size: 4 GB
- Supported file format:
FAT 16/32
- Supported audio format:
MP3

- Maximum current:
500mA
- Compatibility:
USB 1.0/1.1 (The MAX transfer rate is 12M bps for USB1.1.)
- Mass memory support:
USB mass storage (such as an externally attached HDD) is not supported.

■ Playable MP3 File Standards

- Supported standards:
MPEG-1, MPEG-2, and MPEG-2.5
- Supported sampling frequencies:
MPEG-1: 32, 44.1, 48
MPEG-2: 16, 22.05, 24
MPEG-2.5: 8, 11.025, 12
- Supported bit rates:
8 to 320K bps
 - * Supported VBR (64 to 320K bps)
 - * Does not support free format.
- Supported channel modes:
Monaural, Stereo, Joint Stereo, Dual-Channel

■ ID3 Tags

MP3 files have an "ID3 Tag" that allows input of information so that data such as a track title and artist can be saved.

This receiver supports ID3v. 1.0, 1.1, 2.2, 2.3 and 2.4.

■ Format of USB Memory

The following explains the definitions of these standards.

- Maximum directory layers:
8 layers
- Maximum characters for file names:
Up to 254 characters (Total of folder name, file name, ".", and 3-character file extension)
- File name characters that you can use:
A to Z, 0 to 9, and underscore (_)
- Max number of files that can be stored in a single memory:
2000 files

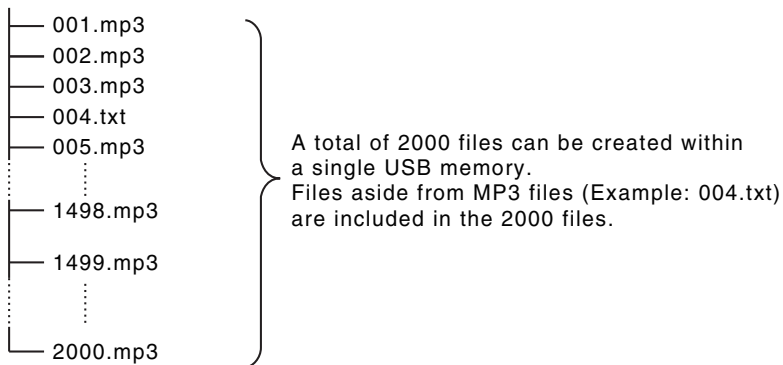

Before Using the DVD Player

This receiver can play high quality images and high quality digital sound of DVD videos. Also, you can select any of languages (such as dubbing and subtitles) recorded on the DVD by switching the video and audio channels. If the same scene is recorded in different angles, you can select an angle and play the video in the desired angle.

Advantages of Digital Versatile Disc (DVD)

■ Multi-Audio Function

Some DVDs support the multi-audio function that enables you to use multiple languages and change the audio language to the desired one.

- * The user's ability to change the audio language depends on the DVD.



■ Subtitle Display Function

Some DVDs support the multi-subtitle display function that enables you to change the subtitle language to the desired one while playing. If necessary, you can disable the subtitle function to play a video.

- * The user's ability to display subtitles depends on the DVD.



■ Multi-Angle Function

Some DVDs support the multi-angle function that enables you to play the same video scene with multiple angles and change to the desired angles while playing.

- * The user's ability to view multiple video angles depends on the DVD.





- The video angle changes.

Discs

■ Types of Playable Discs

This equipment conforms to NTSC color television methods, so please use discs that display "NTSC" on the disc or package. This equipment cannot play discs using color television methods other than NTSC (such as PAL, SECAN).

Type and mark of playable disc	Size/playing side	Max. playing time
	12cm/1 side 1 layers 2 layers	<MPEG 2 system> 133 min. 242 min.
	12cm/2 sides 1 layers 2 layers	<MPEG 2 system> 266 min. 484 min.

ATTENTION

The playback status may be determined in response to the DVD or software creator's intention. This receiver plays disc contents intended by the software creator; therefore, functions may not operate as you intend. Be sure to read the user's guide that comes with the disc to be played.





■ Region Code of Playable Disc

 (region code), which is indicated on some DVDs, represents areas they can be played in. This receiver cannot play discs that do not have "1" or "ALL" indicated on this mark. If you attempt to play such a disc, the message "you cannot play this disc." will appear. Note also that some discs may be subject to regional restrictions, meaning that this receiver will not play them, even though they list or state a region code.

Before Using the DVD Player

■ Mark Indicated on Disc

The following table shows the marks that are indicated on DVDs or packages.

Mark	Description
	Indicates the number of audio tracks.
	Indicates the number of subtitles.
	Indicates the number of angles.
	Indicates the image aspect ratio (ratio between the height and width of the TV screen) able to be selected. ● "16:9" indicates a wide screen, and "4:3" indicates a standard screen.
	Indicates by use of a number regions where the disc can be played. ● "ALL" indicates that the disc can be played anywhere in the world, and the number indicates a region code. "1" is the region number for North America.

■ Disc Configuration

The videos and tracks recorded on a DVD are divided into sections.

A large section is referred to as a title, to which a title number is assigned. A title is divided into chapters, to which chapter numbers are assigned.

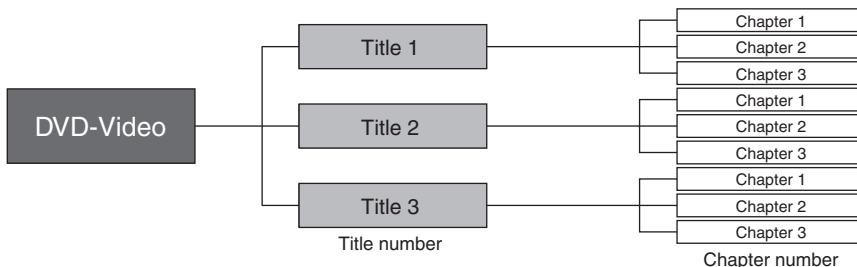

Products equipped with Macrovision

This receiver is equipped with copyright protection technology that is protected under U.S.A. patents and other intellectual property rights, which are held by Macrovision Corporation or other rights holders. Using the copyright protection technology requires the permission of Macrovision Corporation, and the technology must be used only in general households and other limited viewing environments, except when expressly permitted by Macrovision Corporation. Remodeling or disassembly of this machine is prohibited.

Operation Flow

The section explains how to operate the DVD player or search for images or default settings.

- Touching touch switches displays the operation screens shown below.

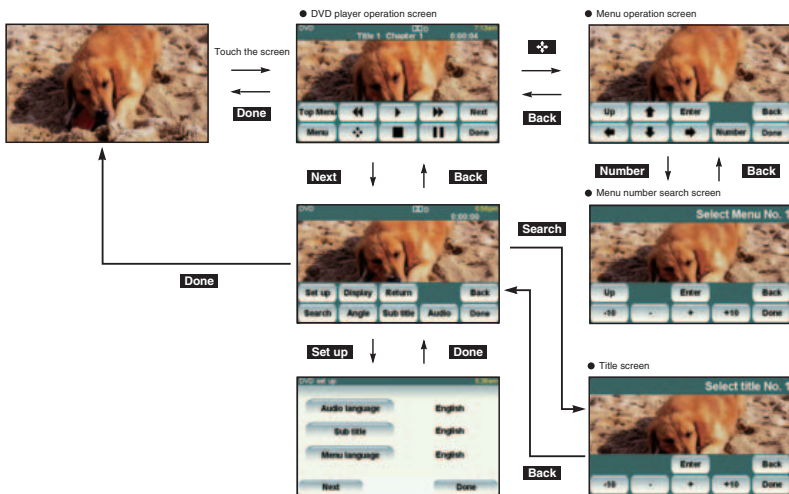

Using the DVD Player

IMPORTANT

To ensure driving safety, you cannot watch a video while driving.

CHECK

You can watch a video on a DVD only when you have stopped your vehicle and applied the parking brake for safety reasons while the engine switch or ACC is turned on. (If the source is switched to the DVD player while the car is moving, only the audio function becomes active.)

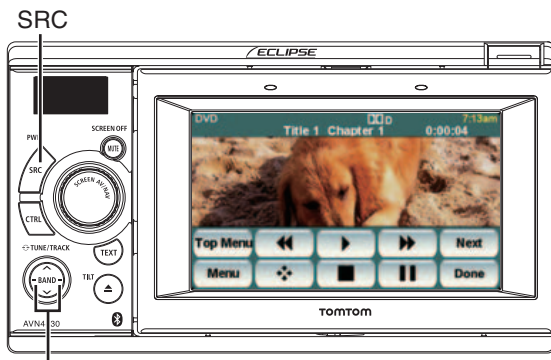

Chapter selection / Fast-forward (rewind) button

Watching a DVD Video

Insert a DVD into the disc slot, and it will start playing.

1 Press the [SRC] button repeatedly until "DVD" is displayed on the sub-display.

- The disc starts to play.
- If the operation switches (touch switches) are not being displayed, touch the screen.
- If you try to play an unsupported DVD, "Cannot read disc. Please check disc." appears.
- If the travel is regulated or the PND is not installed, a DVD is automatically played on the rear monitor after 5 seconds has elapsed in the DVD mode.

Video Operations

IMPORTANT

- The touch buttons and other operation icons are shown approximately 6 seconds. Touching the screen will display them again.
- Depending on the disc, automatic playback may not function, or playback may not function unless a menu recorded on the disc is selected. See "Disc Menu Operations" on page 66

■ Playing a Video

1 Touch .



■ Fast Forward/Rewind

It is possible to fast forward or rewind through the video being played.



Fast Forwarding or Rewinding Using Panel Switch

1 Hold down the [SELECT (Right)] or [SELECT (Left)] button for 1 or more seconds.

- To the right:
Fast forwards a video.
- To the left:
Rewinds a video.

When a beep sounds, the fast forward (or rewind) mode starts and the video is fast forwarded (or rewound) until you remove your finger from the switch.

Fast Forwarding or Rewinding Using Touch Switches



1 Hold down  or  for 1 or more seconds.

- When a beep sounds, the fast forward (or rewind) mode starts and the video is fast forwarded (or rewound) until you remove your finger from the switch.



■ Pausing a Video

1 Touch .

- When video is paused () and when you short touch , the Slow Play starts. When you touch , the frame-by-frame play starts.



■ Stopping a Video

1 Touch .



Using the DVD Player

Disc Menu Operations

You can operate the menu recorded on the disc.

1 Touch **Menu** or **Top Menu**.

2 Touch .



3    Touch , and select the play-back menu.

4 Touch **Enter**.

ATTENTION

The recorded menu items vary depending on the disc. This machine plays what is recorded on the inserted disc; therefore, functions may not operate as intend.

Finding a Desired Video

You can search for the desired video with a title, chapter, or menu number (number assigned for each content).

■ Finding by Chapter

1 Press the [SELECT (Right)] or [SELECT (Left)] button.

● To the right:

When selecting the next chapter

To the left:

When selecting the cue or previous chapter

■ Finding by Title Number

1 Touch **Search**.



2 Touch **-**, **+**, **-10**, or **+10**, and enter the title number.

- If you touch **-** or **+**, the title number is decremented or incremented by 1.
- If you touch **-10** or **+10**, the title number is decremented or incremented by 10.



3 Touch **Enter**.

3 Touch **-**, **+**, **-10**, or **+10**, and enter the menu number.

- If you touch **-** or **+**, the menu number is decremented or incremented by 1.
- If you touch **-10** or **+10**, the menu number is decremented or incremented by 10.



4 Touch **Enter**.

■ Finding by chapter number

1 Touch **+**.



2 Touch **Number**.



Changing the Touch Switch Display

You can change or hide the touch switch display while playing.

■ Hiding the Touch Switch

1 Touch **Done**.

- Touching the screen will display the touch switches again.



Using the DVD Player

■ Relocating the Touch Switch Display

1 Touch .

2 Touch **Up** or **Down**.

- The touch switch display moves up or down each time you touch them.



Changing the Screen Display and Audio Mode

You can change the subtitle language, audio language, or display angle of a video to be played.

■ Changing the Angle

If the target disc supports multiple angles, you can change them to display a video.

CHECK

While the multi-angle mark is displayed on the screen, you can change the currently displayed angle.

Multi-angle mark



1 Touch **Next**.

2 Touch **Angle**.



3 Touch **Change angle**.

- Each time you touch **Change angle**, the angle number is changed, and the angles recorded on the disc are toggled in sequence.



■ Changing the Subtitle Language

If the target disc supports multiple subtitle languages, you can change them to display a video.

⚠ IMPORTANT

Depending on the disc, it may only be possible to change subtitle languages from the top menu.

1 Touch **Next**.

2 Touch **Sub title**.



3 Touch **Change subtitle**.

- Each time you touch **Change subtitle**, the subtitle number is changed, and the subtitle languages recorded on the disc are toggled in sequence.



■ Changing the Audio Language

If the target disc supports multiple audio languages, you can change them while playing.

⚠ IMPORTANT

- Depending on the disc, it may only be possible to change audio languages from the top menu.
- This receiver does not support the dts (digital theater system) format; therefore, no audio will be emitted when "dts audio" is selected for a disc that contains dts audio. If audio is securely recorded on the DVD video with no audio emitted, select "Dolby Digital audio".
- dts is a registered trademark of the US company Digital Theater Systems, Inc.

1 Touch **Next**.

2 Touch **Audio**.



3 Touch **Change audio**.

- Each time you touch **Change audio**, the audio number is changed, and the audio languages recorded on the disc are toggled in sequence.



Using the DVD Player

DVD Player Setting

You can pre-specify the play-back audio mode or the language used to display subtitles or menus. You can also configure settings to display or hide the multi-angle mark or specify the parental screening level.

1 Touch **Next**.

2 Touch **Set up**.



3 If you touch each touch switch, you can configure the following setting.

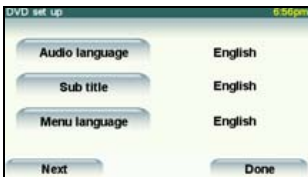

Touch switch	Function	Page
Audio language	Specifies the audio language of a video to be played.	70
Sub title	Specifies the subtitle language of a video to be played.	71
Menu language	Specifies the language used to display the menu.	72
Parental setting	Limits DVD videos that can be played.	73
Video out	Specifies the screen size.	74

4 Touch **Done**.

■ Specifying the Audio Language

You can watch the play-back video in the desired language.

1 Touch **Audio language** on the initial setting screen.

2 Touch the desired language.

- If you touch **Other**, you can specify a language other than the one displayed on the screen.



3 Touch **Done**.

Entering the Code

1 Touch **Other** on the preferential audio language setting screen.

2 Enter the desired language code.

- For the language code, see “Language Code List” on page 75.



3 Touch **Select**.

- Touch **Back** to return to the previous page.

ATTENTION

If the selected language is not compatible with the disc, you will not be able to change to that language.

■ Specifying the Subtitle Language

You can view the play-back video in the desired subtitle.

1 Touch **Sub title** on the initial setting screen.

2 Touch the desired language.

- If you touch **Other**, you can specify a language other than the one displayed on the screen.
- If you touch **OFF**, you can play a video without viewing subtitle on the screen.



3 Touch **Done**.

Using the DVD Player

Entering the Code

1 Touch **Other** on the preferential subtitle language setting screen.

2 Enter the desired language code.

- For the language code, see “Language Code List” on page 75.



3 Touch **Select**.

- Touch **Back** to return to the previous page.

ATTENTION

If the selected language is not compatible with the disc, you will not be able to change to that language.

Specifying the Menu Language

You can specify the language to display menus recorded on the disc.

1 Touch **Menu language** on the initial setting screen.

2 Touch the desired language.

- If you touch **Other**, you can specify a language other than the one displayed on the screen.



3 Touch **Done**.

Entering the Code

1 Touch **Other** on the menu language setting screen.

2 Enter the desired language code.

- For the language code, see “Language Code List” on page 75.



3 Touch **Select**.

- Touch **Back** to return to the previous page.

ATTENTION

If the selected language is not compatible with the disc, you will not be able to change to that language.

■ Specifying the Parental Screening Level

You can restrict viewing of scenes that are inappropriate for children, for example, adult-themed or violent scenes. The parental screening levels can be specified in stages depending on levels.

CHECK

This function is not available for discs that do not support the parental screening level function.

- 1 Touch **Parental setting** on the initial setting screen.

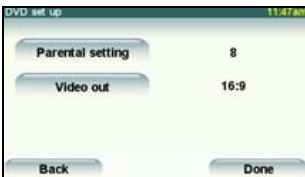

- 2 Touch the number digit by digit to enter the code number.

- If the code number is omitted, “----” is displayed in the upper field.



- 3 Touch **Select**.

- Touch **Back** to return to the previous page.

- 4 Touch the desired parental screening level.

- If you have entered an incorrect code number, eject the disc once, and specify the parental screening level again.

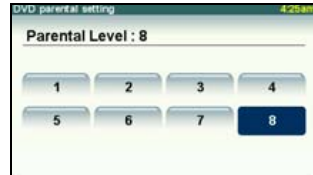

- 5 Touch **Select**.

ATTENTION

- The code number is necessary. If a number is not entered, setting of viewer restriction will not be possible.
- Once a code number is specified, you must enter it when using this item next time and after. Be careful not to forget the code number. If you forget the code number, touch  10 times while the code number field remains blank; you can initialize (clear) the current code number.
- Parental screening levels are classified into the following three types.

Level 1

Plays only DVD software created specifically for children. (Prohibits playing general and adult-themed DVD software.)

Levels 2 to 7

Plays only the general and child-friendly DVD software. (Prohibits playing adult-themed DVD software.)

Level 8

Plays all DVD software. (Default)

Using the DVD Player

Switching the Video Output

1 Touch **Next** on the setting screen.

2 Touch **Video out**.

3 The screen size changes as follows each time you touch **Video out**.

16:9 → 4:3 (LETTER BOX) 4:3 (PAN&SCAN)
→ 16:9 ...

● 16:9

Displayed with a black strip on the upper and the lower edges. DVDs recorded with the 4:3 ratio are displayed in the original ratio, which fits the screen perfectly.

● 4:3 (LETTER BOX)

Displayed in the usual wide size mode. DVDs recorded with the 4:3 ratio are displayed with a black strip on the left and the right edges or in a horizontally spread proportion.

● 4:3 (PAN&SCAN)

The left and the right edges of the video image are cropped. DVDs recorded with the 4:3 ratio are displayed in the original ratio, which fits the screen perfectly.

- The Video Out image is usually set to the output display rate. Usually use the default 16:9 ratio setting, except when you use a 4:3-ratio rear monitor display.

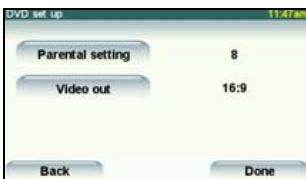

ATTENTION

The user should not experience any problems when watching a video on the wide screen on a personal basis. If you compress or enlarge the screen for commercial purposes or to display to the public, it may infringe a copyright that is protected by copyright laws.

Language Code List

These codes are used to specify the language for audio tracks, subtitles and on-screen menu displays.

Code	Language
1001	Japanese
0514	English
0618	French
0405	German
0920	Italian
0519	Spanish
1412	Dutch
1821	Russian
2608	Chinese
1115	Korean
0512	Greek
0101	Afar
0102	Abkhazian
0106	Afrikaans
0113	Amharic
0118	Arabic
0119	Assamese
0125	Aymara
0126	Azerbaijani
0201	Bashkir
0205	Byelorussian
0207	Bulgarian
0208	Bihari
0209	Bislama
0214	Bengali
0215	Tibetan
0218	Breton
0301	Catalan
0315	Corsican
0319	Czech
0325	Welsh
0401	Danish
0426	Bhutani
0515	Esperanto
0520	Estonian
0521	Basque
0601	Persian
0609	Finnish
0610	Fiji
0615	Faroese
0625	Frisian
0701	Irish
0704	Scots-Gaelic
0712	Galician
0714	Guarani
0721	Gujarati

Code	Language
0801	Hausa
0809	Hindi
0818	Croatian
0821	Hungarian
0825	Armenian
0901	Interlingua
0905	Interlingue
0911	Inupiak
0914	Indonesian
0919	Icelandic
0923	Hebrew
1009	Yiddish
1023	Javanese
1101	Georgian
1111	Kazakh
1112	Greenlandic
1113	Cambodian
1114	Kannada
1119	Kashmiri
1121	Kurdish
1125	Kirghiz
1201	Latin
1214	Lingala
1215	Laothian
1220	Lithuanian
1222	Latvian
1307	Malagasy
1309	Maori
1311	Macedonian
1312	Malayalam
1314	Mongolian
1315	Moldavian
1318	Marathi
1319	Malay
1320	Maltese
1325	Burmese
1401	Nauru
1405	Nepali
1415	Norwegian
1503	Occitan
1513	Oromo
1518	Oriya
1601	Panjabi
1612	Polish
1619	Pashto
1620	Portuguese

Code	Language
1721	Quechua
1813	Rhaeto-Romance
1814	Kirundi
1815	Romanian
1823	Kinyarwanda
1901	Sanskrit
1904	Sindhi
1907	Sangho
1908	Serbo-Croatian
1909	Sinhalese
1911	Slovak
1912	Slovenian
1913	Samoan
1914	Shona
1915	Somali
1917	Albanian
1918	Serbian
1919	Siswati
1920	Sesotho
1921	Sundanese
1922	Swedish
1923	Swahili
2001	Tamil
2005	Telugu
2007	Tajik
2008	Thai
2009	Tigrinya
2011	Turkmen
2012	Tagalog
2014	Setswana
2015	Tonga
2018	Turkish
2019	Tsonga
2020	Tatar
2023	Twi
2111	Ukrainian
2118	Urdu
2126	Uzbek
2209	Vietnamese
2215	Volapuk
2315	Wolof
2408	Xhosa
2515	Yoruba
2621	Zulu

Using the VTR

You can watch a video by connecting a commercially available VTR. You cannot, however, connect the iPod cable (video line) and VTR together.

IMPORTANT

To ensure driving safety, you cannot watch a video while driving.

CHECK

You can watch a video only when you have stopped your vehicle and applied the parking brake to secure safety while the engine switch or ACC is turned on. (When the source is switched to the VTR while the car is moving, only the audio function becomes active.)

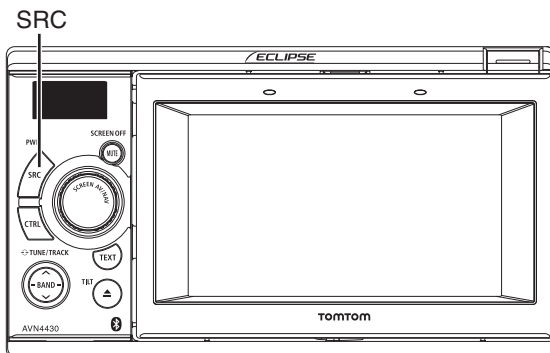

Switching the VTR Mode ON and OFF

1 Hold down the [SRC] button for 1 or more seconds to turn the audio mode Off.

2 Hold down the [CTRL] button for 1 or more seconds.

3 Touch **Enable VTR** that appears on the PND display.

● Checked:

VTR setting is ON.

Not checked:

VTR setting is OFF.

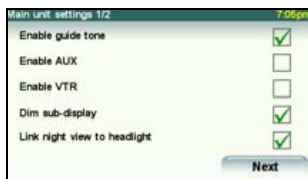

4 Touch **Next**.

5 Touch **Done**.

Playing the VTR

1 Press the [SRC] button repeatedly until "VTR" is displayed on the sub-display.

- The VTR screen appears.
- Touch the screen to change to the VTR operation screen.
- Changing to the VTR operation screen displays each touch switch for approximately 6 seconds.
- If you touch **Done** on the VTR operation screen, the video is displayed again.



ATTENTION

- Whether or not the video is displayed correctly depends on the connected equipment.
- If you have attached your iPod using the iPod cable (iPC-409), this iPod connection has the priority and you cannot use the VTR mode. To use the VTR, unplug the iPod cable first.

Changing the VTR Setting Screen

1 Touch **Display**.

2 Touch **16:9**, **4:3** or **Zoom**.

- This returns to the VTR operation screen.

Turning Off the VTR

1 Hold down the [SRC] button for 1 or more seconds.

Using the iPod Player

Once an iPod is connected, you can play iPod music or video files. Using this receiver, you can perform operations, for example, selecting a file from the list or changing to the random playback mode. You cannot, however, connect the iPod cable (video line) and VTR together.

IMPORTANT

- For details on the iPod functions, refer to the iPod operation manual.
 - It is assumed here that the iPod has already been connected to this main unit with an optional iPod interface cable (IPC-409).
 - Refer to the ECLIPSE Web site (<http://www.eclipse-web.com/us/index.html>) for details on compatible iPod models (generations).
 - To ensure driving safety, you cannot watch a video while driving.
 - You can play a music file on the iPod only when the PND is attached to this receiver.
- iPod is a trademark of Apple Inc., registered in the U.S. and other countries.



Track selection / Fast-forward (rewind) button

Listening to the iPod

CAUTION

- Disconnect headphones and other accessories from the iPod before connecting it to this receiver. Failure to do so may make it impossible to operate the iPod from this receiver.
- If the iPod's equalizer has been preset, sound output may be distorted when it is connected to the optional dedicated connection cable.

IMPORTANT

- When you attach your iPod, the music restarts from the stopped position. If you switched the power ON/OFF or if you detached the PND, the music restarts from the stopped position.
- The iPod will begin playing the music file it was playing before it was connected. If the receiver cannot detect the music file that was playing previously, it will begin playing from the first music file.

1 Press the [SRC] button repeatedly until "IPOD" is displayed on the sub-display.

- Playback will begin.

Fast Forward/Rewind

You can fast forward or rewind the track or the video currently being played.

1 Hold down the [SELECT (Right)] or [SELECT (Left)] button for 1 or more seconds.

- To the right:

Forwards a track or video file.

To the left:

Rewinds a track or video file.

This switches to the fast forward or rewind mode, and continues fast forwarding or rewinding until you remove your finger from the button.

Selecting the Desired Music or Video File

You can select a desired song or video.

1 Press the [SELECT (Right)] or [SELECT (Left)] button.

- To the right:

Advances to the next file.

To the left:

Returns to the beginning of the file being played.

Left (Press more than two times):

Returns to the previous file.

The selected song or the video (file) will be played.

Finding a Desired Music File

⚠ CAUTION

If the iPod or PND is disconnected from this receiver while playing a music file on the iPod, you will return to the previously selected mode.

1 Touch **Select**.



2 To select a track or program to play, touch **Playlist**, **Artist**, **Album**, **Song**, **Genre**, or **Audio books**.

- This displays the list screen of the selected mode.



Using the iPod Player

3 Touch the name of the music file to be played.

- This plays the selected music file.
- When **▲** or **▼** appears, touch them to change the page of the music file list.
- You can search for a file or artist name by touching **Find**.
- You cannot operate the **▲**, **▼**, and **Find** buttons when your car is running.

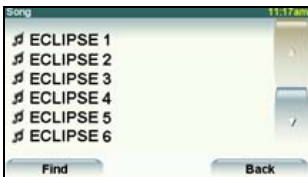

- You can search for a music file by entering alphanumeric characters.

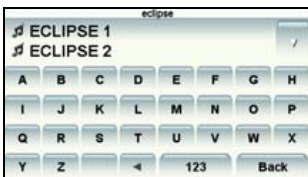

Setting to the iPod Video Mode

You can select and play a desired video file from the iPod memory.

CAUTION

- You can play a video file on the iPod only when the PND is connected to this receiver.
- If the iPod or PND is disconnected from this receiver while playing a video file on the iPod, you will return to the previously selected mode.

1 Touch **Select**.

2 Touch **Video**.

3 Touch the video to be played.

- The iPod video selection screen appears.

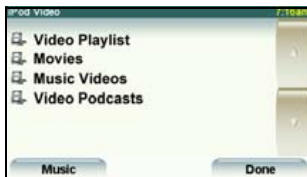

4 Touch the name of the file to be played.

- This plays the selected video file.
- If **▲** or **▼** appears, touch them to change the page of the video file list.
- You can search for a file or artist name by touching **Find**.
- You cannot operate the **▲**, **▼**, and **Find** buttons when your car is running.



- You can search for a video file by entering alphanumeric characters.

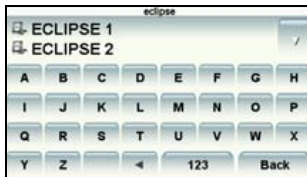

Playing



- 1 Touch .



Pausing

- 1 Touch .





- Touch  to pause the display. Touch  to resume playing.

Repeatedly Playing the Same Music File

- 1 Touch **Preferences**.



- 2 Touch **Repeat song** .

- This repeatedly plays the currently played music file.
- Once you touch **Repeat song** , the selected music file will be repeated until the repeat function is released. Touch **Repeat song**  again to cancel the repeat play.

Random Play of Music Files

- 1 Touch **Preferences**.

- 2 Touch **Shuffle songs** .

- Once you touch **Shuffle songs** , the random play continues until you cancel it. Touch **Shuffle songs**  again to cancel the random play.

Using the AUX

To use the portable audio player, connect it to this receiver using the Ei-LAN.

IMPORTANT

- While the AUX mode is activated, actions such as turning off the audio player or pulling out the connection cord may cause noise spikes that can damage the system speakers. Be sure to avoid this possibility by turning off system power or switching from the AUX mode to another mode before shutting off or disconnecting the portable audio player.
- Audio output levels will differ for the various devices that can be connected by this method. Carefully adjust the volume until the output level of the connected player is known.
- Before using a portable audio player inside a vehicle, read the player's operation manual carefully and confirm you will be able to easily operate the device in the vehicle before proceeding.
- When you connect an optional cable (AUX105) to this receiver, other optional equipment that uses Ei-LAN will not be able to be connected.

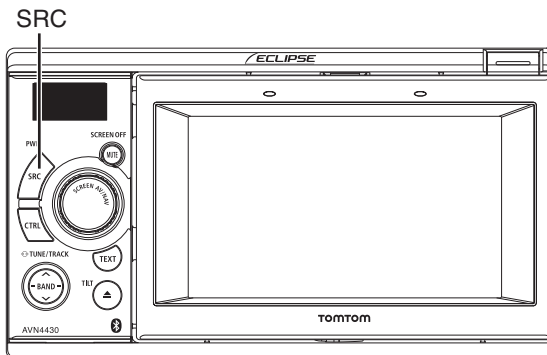

Switching the AUX Mode ON and OFF

- 1 Hold down the [SRC] button for 1 or more seconds to turn the audio mode Off.
- 2 Hold down the [CTRL] button for 1 or more seconds.
- 3 Touch **Enable AUX** that appears on the PND display.

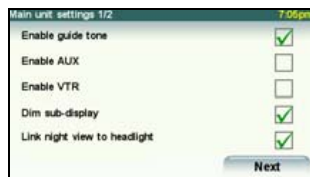

- 4 Touch **Next**.
- 5 Touch **Done**.

- Checked: AUX setting ON
- Not checked: AUX setting OFF

Listening to the Portable Audio Player

For details on how to operate the portable audio player, refer to the instruction manual that comes with the portable audio player.

CAUTION

- Do not operate the portable audio player while driving.
- Audio output levels for the various devices that can be connected using this method will differ. You can adjust the SVC setting level. For details, see “Adjusting the SVC (Source Volume Control)” on page 33.

1 Turn on the connected portable audio player to start playing.

2 Press the [SRC] button repeatedly until “AUX” is displayed on the sub-display.

- The sound from the connected portable audio player will be output.
- If the Enable AUX setting is OFF, “AUX” will not be displayed even if the [SRC] button is pressed. Set Enable AUX to ON. For details, see “Enable AUX” on page 25.

ATTENTION

Regarding the power supply of the portable audio player, use the batteries that come with the portable audio player. If you play the portable audio player while charging with the vehicle power charger or accessory socket, additional noises may be heard.

About the Steering Wheel Switches

On vehicles equipped with steering wheel switches, these easy-access switches can be used to perform the main audio and other operations.

- For details of the steering wheel switch, please contact your local dealer.
- This function may not be available depending on the vehicle type.

Manual setting of steering wheel switch functions

You can manually assign the desired functions to every steering wheel switch buttons.

To do so, turn the power supply off and set it to the standby state. For details, see "Turning the POWER ON or OFF" on page 18.

IMPORTANT

Your manual setting may fail due to the ambient environments including the outdoor temperature.

1 When the power switch is off, hold down both [CTRL] and [TEXT] buttons for 3 or more seconds.

2 Select "CSTM" using the [SELECT (Up)] or [SELECT (Down)] button.

3 Press the [BAND] button.

4 Hold down the [CTRL] button.

- The state of a no signal is read.

5 Select a desired function using the [SELECT (Up)] or [SELECT (Down)] button.

- A function is selected in the following sequence each time you press the button.
TRACK UP ↔ TRACK DOWN ↔ VOL UP ↔ VOL DOWN ↔ MODE ↔ MUTE ↔ PWR ↔ OTHERS ...

6 Press the [BAND] button.

7 Hold down the steering wheel switch button you wish to store in memory, and simultaneously press the [CTRL] button more than two seconds.

- When the function is set correctly, "OK" is displayed.

8 Assign the desired functions to the steering wheel switch buttons by repeating Steps 5 through 7.

9 When you have set all functions, hold down the [BAND] button.

ATTENTION

If "NG" is shown on the display, once again select a desired function to set.

Compatibility with Steering Wheel Switches

The table below shows the compatibility between the steering wheel switches and this receiver.

Operation	Switch	Name	Function	Explanation of operation
Common operations	(+) (-)	Volume switch	Each momentary actuation of these switches changes the volume one step. Hold a switch down for a continuous volume change.	(+): Volume UP (-): Volume DOWN
	(MODE)	Mode selection switch	<ul style="list-style-type: none"> ● When this switch is pressed while the power is turned off, the power is turned on. ● The mode changes in the following order. FM/AM → SIR* → XM* → DISC (CD or DVD) → USB* → AUX* → IPOD* → VTR* → return to FM/AM 	When the power is on, the mode changes each time (MODE) is pressed.
	(POWER)	Power switch	Slightly press this switch to turn the power off.	Turns the power off.
Radio operations	(^) (v)	Channel selection switch	<ul style="list-style-type: none"> ● Calls up the preset broadcast channels in order. ● Starts the automatic channel selection operation. 	Press (^) or (v) briefly to select the next or previous preset channel. Press and hold (^) or (v) longer to start the automatic channel selection operation.
SIRIUS/XM satellite radio tuner operations	(^) (v)	Channel selection switch	<ul style="list-style-type: none"> ● Selects the next preset channel or previous preset channel. ● Switches the category when pressed longer. 	Press for longer to switch the category. Press (^) or (v) briefly to select the next or previous preset channel. Press (^) or (v) for longer to switch the category.

About the Steering Wheel Switches

Operation	Switch	Name	Function	Explanation of operation
CD Player Operations	(^) (v)	Track selection switches	<ul style="list-style-type: none"> ● Selects the next track or previous track or beginning of the current track. ● Fast forward or rewind 	<p>Press (^) or (v) briefly to select the next or previous track.</p> <p>Press and hold (^) or (v) longer to fast forward or rewind a track.</p>
MP3/WMA Player operations	(^) (v)	Track selection switches	<ul style="list-style-type: none"> ● Selects the next or previous file. ● Moves to the next or previous folder. 	<p>Press (^) or (v) briefly to select the next or previous file.</p> <p>Press and hold (^) or (v) longer to select the next or previous folder.</p>
USB operations	(^) (v)	File or folder selection switches	<ul style="list-style-type: none"> ● Selects the next or previous file. ● Moves to the next or previous folder. 	<p>Press (^) or (v) briefly to select the next or previous file.</p> <p>Press and hold (^) or (v) longer to select the next or previous folder.</p>
iPod operations	(^) (v)	Track selection switches	Selects the next track or previous track or beginning of the current track.	<p>Press (^) or (v) briefly to select the next or previous track.</p> <p>Press and hold (^) or (v) longer to fast forward or rewind a track.</p>
Function DVD operations	(^) (v)	Chapter selection and fast forward or rewind switch	<ul style="list-style-type: none"> ● Selects the next or previous chapter. ● Fast forward or rewind 	<p>Press (^) or (v) briefly to select the next or previous chapter.</p> <p>Press and hold (^) or (v) longer to fast forward or rewind a video.</p>

* Option

Backeye Camera Operations

If a separately sold backeye camera is installed, you can play the rearward status on the display when shifting to the back gear. With the ECLIPSE Rear View Camera connected, you can select the viewpoint of a camera view.

CAUTION

The backeye camera plays a mirror-reversed video image in the same way as a rear or side mirror reflects a scene. Be careful that the view angles vary depending on the vehicle model.

IMPORTANT

When using a high-pressure car-wash machine, take care not to directly turn the nozzles on or around the camera. Doing so may result in the camera falling off.

ATTENTION

- Do not place too much confidence in the backeye camera.
- Use the backeye camera as an additional tool to check for obstacles.
- Raindrops on the camera unit may result in a poor video image being displayed.
- Do not reverse your vehicle while only watching the monitor screen. Be sure to look through the rearview and side mirrors together and securely check that conditions are safe around and to the rear of your vehicle.
- Do not use this machine in the following conditions.
 - While driving on frozen, slippery or snow-covered roads
 - Uneven surfaces such as slopes
 - When the rear door is not closed completely.
 - When tire chains or temporary tires are being used.
- When the display is cold, it may be difficult to recognize the contents of the video due to the screening of a darker image or an image lag. Be sure to visually check that conditions are safe around your vehicle while driving.
- The person or obstacle displayed on the screen is different from the actual position or difference due to the characteristics of the camera lens.
- Do not subject the camera unit to a strong impact, for example, hitting the camera unit or impacting the camera unit against a solid object. Doing so may displace the camera position or installation angle, resulting in the backeye camera malfunctioning.
- The camera unit has the waterproof structure. Do not remove, disassemble, or remodel the camera unit. Doing so may result in the backeye camera malfunctioning.
- If you rub or polish the camera cover strongly with an abrasive or brush with hard bristles, it may result in the cover becoming damaged, which may affect the video.
- The camera cover is made of resin. Do not allow any organic solvents, body wax, oil film remover, or glass coating solvent to come in contact with the camera cover. If attached, immediately wipe off it.
- If the temperature changes rapidly, for example, by the spilling of hot water on the camera unit when it is cold, the backeye camera may malfunction.

Backeye Camera Operations

- Hitting the camera unit may result in the backeye camera malfunctioning due to a camera failure. Have your authorized dealer check the problem early.
- Do not direct the camera lens at a brightly sunlight image for a long period of time. Doing so may result in a baking phenomenon occurring.
- The photograph shows an example. The range displayed on the screen varies depending on the vehicle model.
- When you change to reverse gear, the screen will turn white and then the image will quickly return to the screen.
- If the camera unit is exposed to strong light such as sunlight or headlights, a vertically-oriented white zone may appear.
- If the camera is used for a long period of time, white scratches or vertical lines appear as the temperature rises. note that these phenomena are caused due to the CCD characteristics.
- The backeye camera is equipped with a special lens; therefore, distances perceived through viewing the video screen will be different from actual distances.

Playing a Video through the Backeye Camera

■ When the Camera Is Set to MANUAL or AUTO

- 1 Hold down the [SCREEN AV/NAV] button.

- This changes to the backeye camera screen.



■ When the Camera Is Set to AUTO

- 1 Shift to the back gear.

- This changes to the backeye camera screen.



ATTENTION

- The image range displayed on the screen may vary depending on vehicle or road surface conditions.
- The image range displayed on the screen is limited; therefore, you cannot display something that is located near both ends of the bumper or under the bumper.
- Colors shown in the rearward image may be different from the actual colors of the images shown.
- In the following cases, it may be difficult to watch the screen, but it is not an error.
 - In dark places (at night, etc.)
 - The temperature near the lens is high or low.
 - When there are water drops on the camera, or when humidity is high (during rain showers, etc.)
 - Foreign substances (mud, etc.) have become attached to locations near the camera.
 - The camera lens has been exposed directly to sunlight or the rays of headlights.
 - If a high-intensity point (sunlight reflected on the vehicle body, etc.) is reflected on the camera, it may result in a smearing phenomenon* particular to the CCD camera.

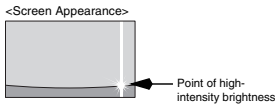

- * Smearing phenomenon: Refers to an image lag that is caused in the vertical direction of a high-intensity point (sunlight reflected on the vehicle body, etc.) reflected on the camera.

Necessary Information

If the Following Messages Appear

If the following messages appear, check the status again, referring to the cause and action.

(PND) : Displayed on the PND screen.

(LCD) : Displayed on the Sub-display.

Message	Cause	Action
In CD/MP3 WMA/DVD mode		
DISC CHECK (PND) INF3 (LCD)	DISCS ARE DIRTY OR DAMAGED	The loaded disc is dirty or upside down. Check it for proper orientation and verify it is clean.
DISC CHECK (PND) INF5 (LCD)	CD PLAYER FAILS MECHANICALLY	The CD player is inoperative for some reason.
DISC ERROR (PND) INF6 (LCD)	WHEN THE CD PLAYER INTERNAL TEMPERATURE IS HIGH (TO PROTECT PICKUP UNIT)	<ul style="list-style-type: none"> ● The temperature in the CD player is too high for operation to continue. Wait till it cools down. ● Resume playing after the "High temperature sensed and CD stopped" message disappears. If the CD still cannot play, have your dealer repair it.
DISC ERROR (PND) INF7 (LCD)	AN INTERNAL POWER SUPPLY FAILURE IS OCCURRING	<ul style="list-style-type: none"> ● Turn the ACC off once before turning it on once again to resume operation. ● If this condition persists, please contact your dealer.
NO SUPPORT (PND) ERR (LCD)	NO CORRECT FILE IN CD	Confirm the file.
DISC CHECK (PND) INF3 (LCD)	The CD/MP3 WMA/DVD is dirty, scratched, warped or upside down.	Clean the disc if it is dirty. Insert the disc correctly if it is upsidewdown. Do not use the scratched or warped disc.
DISC ERROR (PND)	The CD/MP3-WMA or DVD player is not operating for some reason.	Eject the disc.
DISC ERROR (PND) INF6 (LCD)	The temperature of the CD/ MP3-WMA or DVD player has become unusually high.	Without performing any other operations, wait until the temperature comes down *.
Pass code incorrect (PND) ---- (LCD)	This message is displayed when the pass code that has been entered is not correct.	Enter the correct pass code.
Parental lock enabled (PND) ERR (LCD)	Viewing restrictions are enabled.	Change the setting for viewing restrictions and start again.(See page 73)
Currently this function is disabled. (PND) ---- (LCD)	A function that has been disabled was selected with the menu.	Follow the directions on the screen and start again.

Message	Cause	Action
Currently this function is disabled. (PND) ---- (LCD)	A function that cannot be used while the vehicle is in motion was selected.	Stop the vehicle and set the emergency / parking brake.
Invalid code (PND) ---- (LCD)	A number not supported was input for selecting a language code.	Input a valid language code.
Region code error (PND) ERR (LCD)	The region code (controlled region for playback) of the disc is not acceptable.	Check that the DVD has a region code that can be played on this equipment.(See page 61)
Requested chapter or title not found. (PND) ---- (LCD)	The selected chapter/title does not exist.	Select a chapter/title that is on the disc.
In USB mode		
NO DATA	NO CORRECT FILE IN USB MEMORY	Confirm the file.
USB READ ERROR	PROBLEM WITH DATA TRANSMISSION	Confirm connection with USB memory or USB memory standards.
Don't remove the storage device until scanning is finished. (PND) - (LCD)	This machine is currently reading USB data.	Wait for a brief period.
No songs found (PND) ERR (LCD)	The USB include no tracks.	Import tracks to the USB to play them.
External USB device is not supported. (PND) ERR (LCD)	Communication or play-back error	Wait until the error is corrected, or change the mode.
In SIRIUS mode		
ANTENNA(PND) ANT(LCD)	The SIRIUS antenna is disconnected.	Check the connection of the SIRIUS antenna.
ACQUIRING(PND) --- (LCD)	Displayed when the SIRIUS satellite radio signal is lost (during access)	Try receiving the signal again in the place where there are no obstacles.
LINKING(PND) -(LCD)	SIRIUS Satellite RADIO SIGNAL RECEIVING FAILS	Adjust the SIRIUS antenna position to receive the satellite signal.
CALL888-539-SIRI(PND) "CALL", "888", "539", "SIRI"(PND)	You are tuned to a valid SIRIUS channel but you are not subscribed to that channel.	Subscribe to SIRIUS. Or, check/change your subscription plan.
SUB UPDATED(PND) *** (PND)	Displayed when your SIRIUS channel subscription has been accepted and your status is being updated to allow you to receive the channels.	After this message is displayed, the channels for which you do have a subscription can be received.
INVALID CHANNEL(PND) _(LCD)	Displayed when you are tuned to a SIRIUS channel that you cannot receive.	Tune to channels that you can receive.

Necessary Information

Message	Cause	Action
UPDATING(PND) UPDT(LCD)	Displayed while the channel map is being updated.	After this message is displayed, subscribe to SIRIUS. The channels for which you do have a subscription can be received.
In XM mode		
CHECK ANTENNA(PND:flashing) ANTENNA(LCD)	The XM antenna is disconnected.	Check the connection of the XM antenna.
NO SIGNAL	Displayed when the XM satellite radio signal is lost (during access)	Try receiving the signal again in the place where there are no obstacles.
OFF AIR	Displayed when the XM channel you are tuned to is not currently on air.	Tune to channels currently on air.
LOADING	Obtaining audio and information data for the XM channel.	Wait for a brief period.
In iPod mode		
This device cannot be connected in this way - use a different cable. (PND) ERR (LCD)	The iPod has been connected to the USB port.	Wait until the error is corrected, or change the mode.
READING (PND) - (LCD)	This machine is currently detecting iPod data.	Wait for a brief period.
No songs found (PND) ERR (LCD)	The iPod include no tracks.	Import tracks to the iPod to play them.
No videos found (PND) ERR (LCD)	The iPod contains no video.	Import a video file for the iPod to play.
No songs or videos found (PND) ERR (LCD)	The iPod contains neither tracks nor video.	Import a track or video file for the iPod to play.
Unable connect to iPod (PND) ERR (LCD)	A communication error, playback error, iPod software incompatibility, or control error occurred.	Connect a playable iPod.

* If this happens, wait for a brief period. When the temperature inside the equipment returns to normal, the message will disappear and playback will start. If the message does not disappear after a long period of waiting, contact the place of purchase.

When You Think There Is a Malfunction

A slight difference in operation may be mistaken for a malfunction. Please check the items in the following table first.

If the unit does not work, even after the appropriate remedial action has been taken, please contact your dealer.

CAUTION

If a problem occurs, for instance when the receiver or PND does not respond to any button presses, or the display does not work correctly, press the [Reset] button using a paper clip or similar item.

Pressing the [Reset] button will delete all the entries from memory. The settings will return to those made at the factory prior to shipment.

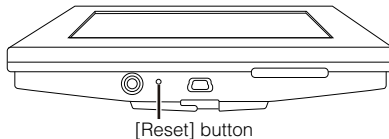

Phenomenon	Possible cause	Action
The screen is dark for a brief period when the power is turned on at low temperatures.	This is a characteristic of LCDs.	This is not a malfunction. Wait for a brief period.
The display is distorted for a brief period after the power is turned on.	This is a characteristic of LCD backlighting.	This is not a malfunction. The display will stabilize after a brief period.
No sound comes out.	Volume is poorly adjusted or MUTE is functioning.	Turn the VOL rotary knob to adjust the volume, or release MUTE.
	The music is muted when the PND is attached to the main unit and when: <ul style="list-style-type: none"> ● the voice guidance is ON. ● talking in the hands-free mode 	This is not a malfunction. The music can be heard again when the voice guidance finishes or the hands-free mode is turned off.
Sound comes out of only one side (left or right, front or back).	A speaker wire is disconnected.	Check the connections of the speaker wires.
	Volume is poorly adjusted.	Check the balance and fader adjustments.
Sound quality does not change even after making adjustments.	The adjusted audio quality is not included in the radio broadcast or disc.	Check by changing the radio station or disc.
A CD/DVD will not go into the deck.	Power is not turned on.	Turn the vehicle ignition switch to [ACC] or [ON].
	A disc is already inserted and you are trying to insert a second disc.	Eject the previously inserted CD/DVD and insert the preferred CD/DVD.

Necessary Information

Phenomenon	Possible cause	Action
A CD/DVD cannot be played.	There is water condensation inside the equipment.	Stop using the equipment for a short time and then try using it again.(See page 14)
	There is a large scratch or warp in the CD/DVD.	Insert a different CD/DVD.
	The CD/DVD is very dirty.	Clean the CD/DVD.(See page 14)
	The CD/DVD is upside down.	Insert the CD/DVD with the proper orientation.
	A non-supported type of CD/DVD has been inserted.	Insert a CD/DVD that is supported in the deck(See page 14)
Audio is output, but not video.	The screen has been turned off with the screen OFF button.	Press the [SCREEN AV/NAV] button.(See page 19)
Audio is output, but not DVD video. (With vehicle stopped.)	The emergency / parking brake has not be set.	Set the emergency / parking brake.
Neither video nor audio is output.	The vehicle ignition switch has not been turned on.	Turn the vehicle ignition switch to [ACC] or [ON].
	The connection wires and cables are not completely connected.	Check the connections to each connection wire and cable.
There is a point of light on the display.	At least 99.99% of the pixels on the LCD panel are effective, but it is possible that 0.01% of the pixels may not light or may stay lighted.	This is not a defect, so please use the equipment in this condition.

* Depending on your mobile phone, the mute function may not work correctly. If it does not, press the [MUTE] button on the main unit. Refer to the ECLIPSE Web site (<http://www.eclipse-web.com>) for details on applicable phone models.

Specifications

<GENERAL>

Power Supply	13.2V DC (11 to 16V)
Current Drain	3A
Dimensions (whole unit) (W × H × D)	7" × 4" × 6-1/2" (180 × 100 × 165 mm)
Weight (whole unit)	5.5 lbs (2.5 kg)
Dimensions (PND only) (W × H × D)	5" × 3" × 1" (130 × 82.5 × 24.5 mm)
Weight (PND only)	0.4 lbs (0.2 kg)
Operating temperature range (whole unit)	-4°F to 149°F (-20°C to +65°C)
Operating temperature range (PND only)	14°F to 131°F (-10°C to +55°C)
PND storage guarantee temperature*	-4°F to 140°F (-20°C to +60°C)
Storage temperature range (audio only)	-20°F to +185°F (-40°C to +85°C)
Suitable load impedance	4Ω

* Do not leave this machine inside a vehicle for a long period of time if there is a possibility the guaranteed PND storage temperature may be exceeded. Doing so will result in a failure.

<DISPLAY>

DISPLAY	4.3" WQVGA
Resolution	480 × 272 pixels

<FM TUNER>

Frequency Range	87.75 to 107.9 MHz (200 kHz step) (North America)
	87.75 to 107.9 MHz (100 kHz step) (Latin America)
	87.5 to 108 MHz (50 kHz step) (Asia)
Effective sensitivity	15dBf
50dB Quieting Sensitivity	24dBf
Stereo Separation	40 dB (1 kHz)

<AM TUNER>

Frequency Range	530 to 1710 kHz (10 kHz step) (North America)
	530 to 1710 kHz (10 kHz step) (Latin America)
	522 to 1629 kHz (9 kHz step) (Asia)
Usable Sensitivity	27 dB (1 kHz)

Specifications

<CD/DVD SECTION>

Frequency Response	20Hz to 20,000Hz \pm 3dB
Wow & Flutter	Below measurable limits
Channel Separation	65 dB
S/N Ratio (A-weighted)	CD: 75 dB DVD: 70 dB
Dynamic Range	95 dB
Total Harmonic Distortion	0.008%

<USB MEMORY SECTION>

USB Interface	1.1
Frequency Response	20Hz to 20,000Hz \pm 3dB
S/N Ratio (A-weighted)	75 dB

<EQUALIZER SECTION>

Bass/Mid/Treble Control	\pm 11dB at 80 Hz, \pm 11dB at 700 Hz, \pm 11dB at 10 kHz
-------------------------	-----------------------------------------------------------------

<AUDIO AMPLIFIER>

Power Output	15 W \times 4 Max. 50 W \times 4 MOS-FET
Output Level/Impedance	3V/1k Ω line-out impedance
Loudness	+9 dB at 100 Hz, +6 dB at 10 kHz

The information contained in this manual may not be completely applicable to this receiver due to changes in product specifications, external view, etc.

How to Contact ECLIPSE

Fujitsu Ten Corp. of America (Eclipse)

19600 South Vermont Avenue, Torrance, CA 90502

Phone: 1-800-233-2216

Free Manuals Download Website

<http://myh66.com>

<http://usermanuals.us>

<http://www.somanuals.com>

<http://www.4manuals.cc>

<http://www.manual-lib.com>

<http://www.404manual.com>

<http://www.luxmanual.com>

<http://aubethermostatmanual.com>

Golf course search by state

<http://golfingnear.com>

Email search by domain

<http://emailbydomain.com>

Auto manuals search

<http://auto.somanuals.com>

TV manuals search

<http://tv.somanuals.com>