

ECLIPSE®

by FUJITSU TEN

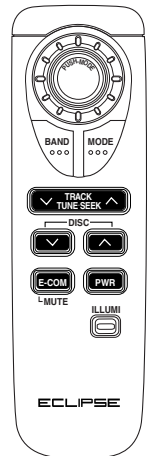
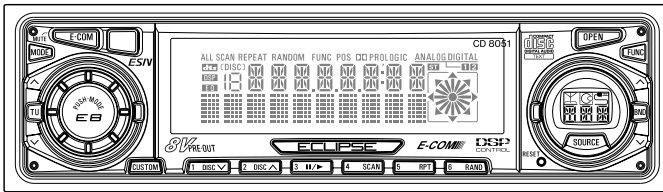

MODEL **CD8051**

ESN E8 CD Tuner with
CDC/E-COM/DSP Control and NOB Remote

OWNER'S MANUAL

We appreciate your purchase of this tuner.
Please read through this manual for correct operation.
We suggest that after reading it you keep this manual
in a safe place for future reference.

For your safety in using the CD8051

Warnings and caution signs, illustrated below, are posted throughout this manual as well as on the CD8051. They show safe and correct ways to handle the product so as to prevent personal injury to you and others and avoid damage to property.

Before reading through the manual, take time to read through and learn the important information listed in this section.



Warning

This sign indicates a situation in which incorrect handling through disregard of a sign might result in death or serious personal injury.



Caution

This sign indicates a situation in which incorrect handling through disregard of a sign might result in personal injury or may result solely in damage to property.



Warning

- Do not modify this system for use other than that specified herein. Also, do not deviate from the installation procedures described herein; Eclipse will not be held liable for damages including, but not limited to serious injury, death or property damage resulting from installations that enable unintended operation.
- This unit is intended for operation in DC 12-volt, negative-grounded vehicles only. Never use it in 24-volt vehicles such as heavy trucks or diesel cars with cold-region specifications.
- Do not change CDs while driving. Doing so may result in an accident.



Warning

- Do not place the vinyl storage bag over a person. It may cause a serious accident or death by suffocation.
- Do not adjust the controls while driving the car. To adjust the controls, stop the car in a safe location.
- To prevent accidents, store batteries for the remote control out of the reach of small children. In case a child swallows a battery, consult a physician immediately.
- Do not disassemble or rebuild this product. Doing so may cause an accident, fire or electrical shock.
- When it is necessary to replace the fuse, always use a fuse of the correct rating (number of amperes). Use of fuses with higher amperage ratings may cause a fire.
- Do not operate the product in a malfunctioning condition, for instance, when the audio does not play. Doing so may result in an accident, fire or electrical shock.
- If an abnormal situation occurs, such as foreign matter entering or liquid splashing on the product, or smoke or a strange odor emitting from the unit, shut off the product immediately and consult the dealer from whom you purchased it. Continued operation may cause an accident, fire or electrical shock.
- Do not install this product in locations where it may obstruct the driver's view, or where it may endanger passengers in the vehicle. Otherwise, an accident or injury may result.
- Do not install this product in locations where it may interfere with the operation of the steering wheel, shift lever, brake pedal, etc. Otherwise, an accident or injury may result.
- When installing this product, never use existing nuts or bolts that secure parts of the fuel tank, or the steering or braking systems. Otherwise improper steering or braking or a fire may result.

 **Warning**

- To prevent a short circuit from occurring, disconnect the battery's negative terminal before installing this product. Otherwise, an electric shock or injury may result.
- When using an existing nut and/or bolt from the vehicle to ground this product, do not use any that secure parts of the steering or braking systems. Otherwise, an accident may result.
- Bundle cables and harnesses with electrical tape or wire ties to prevent them from interfering with moving parts. If they should entangle the steering wheel, shift lever or brake pedal, an accident may result.
- Never supply power to another electrical appliance by splicing or tapping into this product's power lead (wire). Otherwise, the current capacity of the wire will be exceeded, resulting in a fire or electric shock.
- Never attempt to disassemble or modify the product. Otherwise, an accident, fire or electric shock may result.
- When installing the product into a vehicle with a passenger side air bag, do not secure it to the air bag's cover or in places where it may impede air bag deployment. Otherwise, proper air bag operation may not be ensured in the event of an accident, causing injury or death.
- When making holes using a drill or similar tool, be sure to wear protective eyewear. Otherwise, an injury such as loss of eyesight may result.
- Exposed wires must be insulated with electrical tape. Otherwise, a short circuit, fire, or electric shock may result.

 **Caution**

- Play the audio at a moderate volume level that permits you to hear sounds from outside the car. Driving without being able to hear outside sounds may result in an accident.
- Keep foreign objects out of the disc slot. They may cause fire or electrical shock. Another possibility is that discs may be damaged or become stuck.
- Do not stick your fingers or hands into the disc slot. Doing so may cause personal injury.
- This product must be operated only as on-board equipment, or it may cause electrical shock or injury.
- Do not play distorted sounds for long periods of time; the speakers may overheat and cause a fire.
- Never use batteries other than those specified. Do not mix new and old cells. Doing so may cause a fire or personal injury due to a battery explosion or chemical leaks.
- Pay attention to the (+) and (-) polarity of the battery when installing them in the product. Incorrect installation may cause personal injury or product damage spoilage due to a battery explosion or chemical leakage.
- For best results, this product should be installed by a professional installer.
Contact the dealer whom you purchased the product for an appointment.
- When installing this product, be sure to use the supplied mounting hardware. If parts other than those supplied are used, the unit may be damaged internally, or may not be held in place securely and become dislodged.



Caution

- Avoid installing this product in places where it may get wet, such as near windows, or in places that are moist or dusty. Presence of liquid, moisture or dust inside this product can cause short circuiting, resulting in smoke or fire.
- Do not install this product in locations where it cannot be fastened securely, such as places subject to frequent vibration. Otherwise, it may become dislodged and cause an accident or injury.
- Do not block this product's vent or heat sink. If either is blocked, excessive heat build-up may occur and cause a fire.
- If this product is not connected properly, a short circuit, fire or accident may occur.
- When routing cables, use care so that they do not contact sharp metal parts such as brackets or screw tips. Otherwise, a short circuit, electric shock, fire or accident may result.
- Do not obstruct the vent on this product. If blocked, excessive heat build-up may occur and cause a fire.

Table of Contents

<i>Operating precautions</i>	10
Notes on operation	10
About compact discs	12
About cleaning a CD	15
<i>Names of controls and parts</i>	16
<i>ESN (Key CD) security operating procedure</i>	17
How to program the Key CD	17
How to cancel the Key CD	18
How to change the Key CD	19
How to resume normal operation (ESN security lock out)	20
What happens if an incorrect CD is inserted?	21
How to turn the security indicator on/off	22
How to read the Electronic Serial Number	23
<i>Basic operation</i>	24
Turning the power on and off	24
Listening to a CD	24
Listening to the tuner	25
Adjusting audio volume	26
Displaying the clock	26
Others	27
<i>How to operate the CD player</i>	36
Listening to CDs	36
Advancing to the next track or returning to the beginning of the track being played	37
Playing the beginning of tracks (SCAN)	37
Repeating the same track (REPEAT)	38
Playing tracks in random order (RANDOM)	38
Switching a CD to pause / play	38
Ejecting the disc	39
Creating a title for a CD	40
Changing a previously set title	42
Deleting a previously created title	43
Changing the number of CD titles	44
Displaying CD text	45

How to operate the tuner 46

Tuning to a station	46
Entering stations into memory automatically (The automatic preset mode: ASM)	47
Manually setting stations into memory	48
Preset station scan	49
Setting a station name	50
Deleting a station name	52
Setting a band category	53
Deleting a band category	55
Changing the number of bands	56
FM reception characteristics	57

How to use the NOB remote control 60

Precautions in use of the remote control	60
Cleaning the remote control	60
Turning the power on/off	61
Adjusting the audio volume	61
Switching playback modes	62
How to play the tuner	62
How to play CDs	63
Illuminating the NOB remote control	64
Enabling the optional E-COM feature	64
Switching the remote control settings	65
Replacing the battery	66

How to use an optional Card remote control 68

Turning the power on/off	68
Adjusting the audio volume	68
Switching playback modes	69
How to play the tuner	69
How to play CDs	70
Switching the remote control settings	72
Replacing the battery	73

***How to operate the receiver with an
optional CD changer connected 74***

Basic operation	74
-----------------------	----

<i>How to operate the receiver with an optional DSP/EQ unit or Digital Sound Processor connected ...</i>	77
How to operate the DSP functions	77
How to operate the EQ functions	81
How to operate the Digital Sound Processor	84
<i>If you have a question:</i>	92
Displayed information (for troubleshooting)	93
<i>Specifications</i>	96
<i>Before installation</i>	97
Components	97
<i>Mounting instruction</i>	98
Mounting the main unit	98
Names of lead wires and destinations	100
System	101

◆ Operating precautions

<Your CD8051 will perform well over a long period of time through correct handling and care.>

Notes on operation

- For your safety, play only at volume levels that allow outside sounds to be heard.

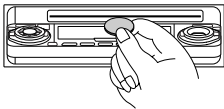

- Use only audio compact discs.
This player can only play compact discs bearing the logo shown to the left.
- It may not be possible to play back some tracks on CD-Rs.
- It may not be possible to play back CD-Rs with certain characteristics, or CD-Rs which are scratched, dirty, or which have been left inside a vehicle for long periods.
- CDs cannot be played back until all sessions recorded on the CD-R have been closed.
- CD-RW discs cannot be played back.
- Do not insert anything other than a CD into the disc slot.
Do not insert any foreign objects, such as coins or credit cards, into the disc slot. Be especially watchful of children's mischief in this regard.
- Avoid severe mechanical shock.
When the player is subjected to severe vibration while traveling over a rough surface, playback may be intermittent. When a situation like this occurs, resume playback after returning to a smoother road.



- About dew condensation.
In cold or rainy weather, just as the interior glass surface gets fogged, dew (water condensation) may also settle on the deck. When this occurs, disc playback may become intermittent or impossible. Dehumidify the air in the vehicle for a while before resuming playback.

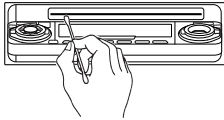

- Cleaning the disc slot.
The disc slot tends to get dusty. Clean it occasionally to prevent accumulated dust from scratching the discs.

About compact discs

- The signal recorded on a compact disc is read by a laser beam, so nothing touches the disc surface. A scratch on the recorded surface or a badly warped disc may cause deteriorated sound quality or intermittent playback. Observe the following precautions to ensure high quality sound performance:

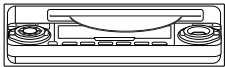

- Do not leave an ejected disc in the disc slot for very long; the disc may warp. Discs should be stored in their cases and kept away from high temperature and humidity.

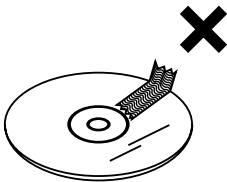

- Do not stick a piece of paper or tape on, nor write on or scratch either side of a disc.

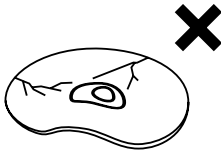

- Discs spin at a high speed inside the deck. Keep cracked or warped discs out of the player to avoid damaging it.

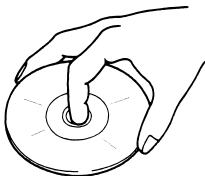

- Avoid touching the recorded surface when handling a disc; handle discs by their edges.

About brand new CDs

- You may notice that some brand new discs are rough around the center hole or outside edge. Remove the rough edges with the side of a ballpoint pen, etc. Rough edges may prevent proper loading in the deck. Flakes from the rough edges may also stick to the recorded surface and interfere with playback.

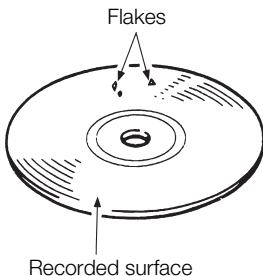
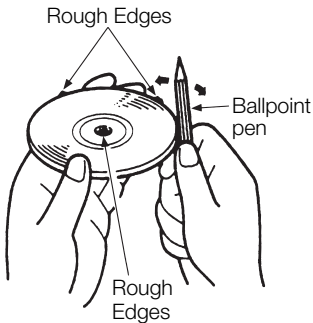

About CD accessories

- Do not use accessories (stabilizers, protective seals, laser lens cleaners, etc.) sold for "improving sound performance" or "protecting CDs." The changes in CD thickness or outside dimensions made by these accessories may cause problems in the player.

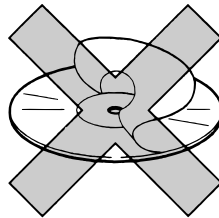

- Please be sure NOT to attach any ring-shape protector (or other accessory) to your discs. Those protectors are commercially available and said to protect disc and to improve sound quality (and antivibration effect), but they can do more harm than good in regular uses. The most common problems are Insert/Eject related problems and "No playback" problems due to the protectoring that came off in the disc mechanism.

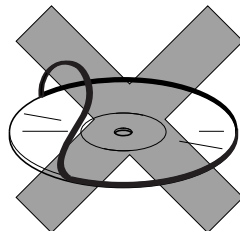

Operating precautions

About borrowed CDs

- Do not use a CD with glue or remnants of adhesive tape or labels. They may cause the CD to get stuck inside or damage the deck.

How to remove CDs

- When removing the ejected disc, pull it straight out along the slot. Pressing downward in the process may scratch the recorded surface of the disc.

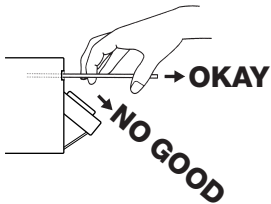

About irregularly-shaped CDs

- Specially-shaped CDs, like heart-shaped or octagonal CDs, cannot be played. Do not attempt to play them, even with an adapter, since they may damage the player.

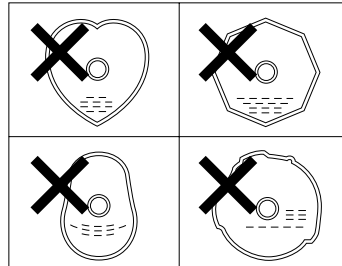

About cleaning a CD



- Use a commercially available compact disc cleaner to clean a CD, wiping lightly from the center to the edge.

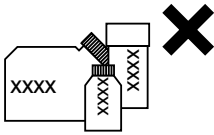

- Do not use benzine, thinner, LP record spray or other cleaners on CDs. They may damage a CD's finish.

◆ Names of controls and parts

Front view

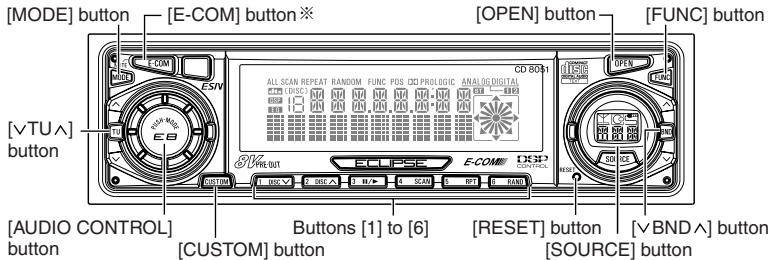

NOTE : Double function button → "E-COM" & "MUTE" functions



Though the words "press" and "tap" are used in the text for the operation of the [V TU ^] button and [V BND ^] button, the button is actually slid in the ^ or v direction.

With the front open

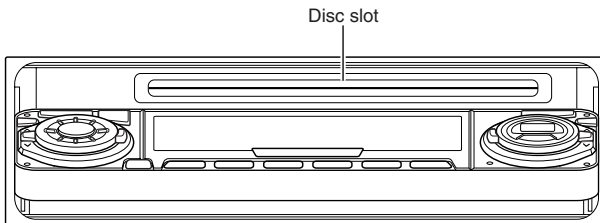

● Caution ●

Never place an object or rest your hands or the like on the front panel.

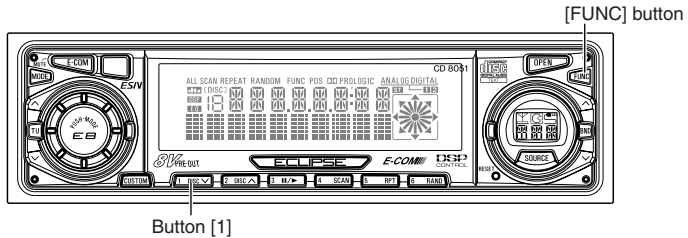

◆ ESN (Key CD) security operating procedure

■ How to program the Key CD

- 1** Check that the Power is OFF.
- 2** Press and hold button [1], then the [FUNC] button, and hold both for more than one second.
A [SEC] message appears, then in two seconds it will change to [DISC].
The front panel opens; the CD8051 is now ready to accept your Key CD in the CD slot.
- 3** Insert the CD into the slot.
The front panel closes.
A [SEC] message appears, the front panel opens, then the Key CD is ejected.

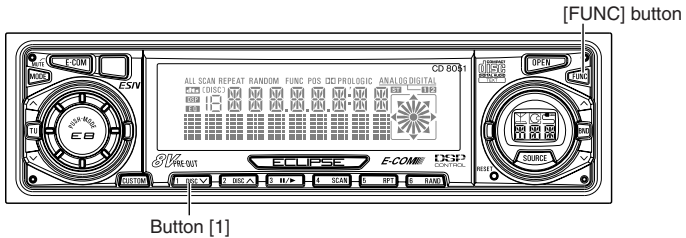

ATTENTION

- If there is a problem with the inserted CD, an [ERR] message will appear for two seconds and the CD will be ejected. Reinsert the ejected CD.
- If a CD causes the [ERR] message to appear twice in a row, a [CHANGE] message will appear for two seconds. Try another CD.
- The Security indicator will flash whenever the vehicle's ignition is switched off.

■ How to cancel the Key CD

1 ■ Turn OFF the Power.

2 ■ Press and hold button [1], then the [FUNC] button, and hold both for more than one second.

A [SEC] message appears, then in two seconds it will change to [DISC].

The front panel opens; the CD8051 is now ready to accept your Key CD in the CD slot.

3 ■ Insert your Key CD into the slot.

The front panel closes.

A [CANCEL] message appears, the front panel opens, then the Key CD is ejected.

The Key CD is cancelled.



- This process cancels the protection for the ESN deck.
- If power to the ESN deck is disconnected, then reconnected, a Key CD will not need to be inserted in order to return the unit to normal operation.
- Inserting a CD other than the Key CD will not cancel the protection. Instead, the display will show [ERR] for two seconds, then the normal CD playback mode will activate.

■ How to change the Key CD

- 1** ■ **First, cancel the existing Key CD.**
Refer to “How to cancel the Key CD.”
- 2** ■ **Next, program a new Key CD.**
Refer to “How to program the Key CD.”

■ How to resume normal operation (ESN security lock out)

If power is disconnected while ESN security is active (a Key CD was programmed), operation is disabled until power is restored and the unit unlocked. Follow this procedure to resume normal operation.

1 ■ When the power is turned on after disconnecting the battery power, a [SEC] message will appear for two seconds. Thereafter, the message changes to [DISC] and the CD8051 is ready to accept your Key CD into the slot.

2 ■ Insert your Key CD.

If the correct CD is inserted, an [OK] message will appear for two seconds and the CD will begin playing.



- If an incorrect CD is inserted, an [ERR] message will appear for two seconds, after which the CD will be ejected.
- You must use the same CD used for Key CD programming; a duplicate CD may not work properly.

■ What happens if an incorrect CD is inserted?

1 ■ An [ERR] message will be appear, then change to a flashing [DISC], then the CD will be ejected.

You will have five uninterrupted attempts to insert the correct CD.

2 ■ After the 5th incorrect attempt, the display reads [HELP].

3 ■ If [HELP] appears on the screen, press button [6], then the [FUNC] button, and hold them for five seconds.

4 ■ Press the [FUNC] button.

You will have five more attempts the correct disc.



Number of errors: Numbers indicated the number of errors that occurred.

● Note ●

If after 10 tries the correct Key CD is not inserted, the display reads [CALL800]; the unit must be returned to Eclipse to be reset. In this case, please contact your Eclipse dealer for assistance or call Eclipse directly at (800) 233-2216.

Your key CD can be easily forgotten. Write the album name in a reminder note (See Page 107).

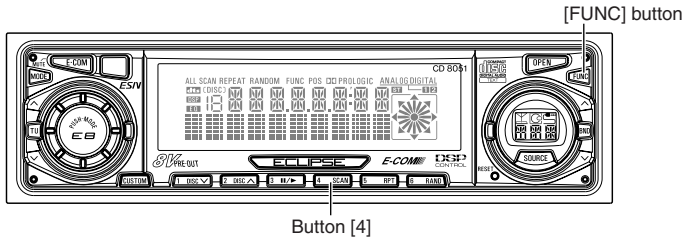

■ How to read the Electronic Serial Number

1. Turn OFF the Power.
2. Press button [4], then the [FUNC] button, and hold both for more than one second.

[ESN] appears on the display, followed by an eight-digit number; this number is your electronic serial number (ESN). You may use this number to identify your Eclipse CD8051 in the event it is recovered after being stolen.

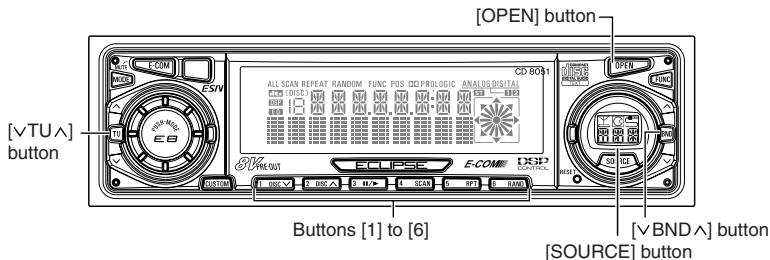

◆ Basic operation

This section covers basic operating procedures. For additional details, please refer to the sections on specific functions.

■ Turning the power on and off

When the power is turned on, the state used when the power was turned off such as CD and tuner playing is restored.

1 ■ Press the [SOURCE] button.

Pressing the button turns the power on and off.

Less than two second:

Pressing the [SOURCE] button repeatedly while the power is turned on will switch the modes in the order of Tuner → Disc → AUX → PWR OFF (Stand by).

Non-shiftable modes are skipped.

More than two second: Off



If a car is not equipped with an ACC position (for example, a European car), keep the [SOURCE] button depressed for more than two seconds.

■ Listening to a CD

1 ■ Press the [OPEN] button.

The front panel opens.

2 ■ Insert a CD into the disc slot, label side up.

The CD will immediately start playing.



When a CD is already loaded, press the [SOURCE] button repeatedly to switch to the CD mode.

■ Listening to the tuner

1 ■ Press and hold the [SOURCE] button until the mode switches to the tuner mode.

This will turn the tuner on.

To turn the tuner off, press the [SOURCE] button either shorter to select another mode or longer to turn the power off.

2 ■ Tap the [∇ BND ^] button to switch to the desired FM or AM bands.

[BND ^] button: Switch the FM band.

Pressing the button repeatedly switches the FM band in the order of FM1 → FM2...

[BND ∇] button: Switch the AM band.

Pressing the button repeatedly switches the AM band in the order of AM1 → AM2...

It is also possible to change the numbers of FM and AM bands in a certain combination of them (See Page 56).

3 ■ Press the [∇ TU ^] button to tune to a station.

A tap on either the [∇ TU ^] button for less than one second will enable manual station tuning. Hold one button down for more than two seconds to start the automatic station search.

[TU ^] button: Starts searching toward higher frequencies.

[TU ∇] button: Starts searching toward lower frequencies.



If stations have been stored in memory, pressing a button from [1] to [6] will directly select a station. (Refer to the section "Manually setting stations into memory" on page 48)

Basic operation

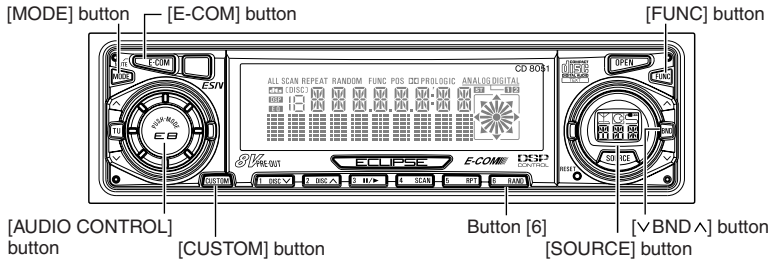

■ Adjusting audio volume

1. Turn the [AUDIO CONTROL] button to the left or right.
 - Turn to the left : Decreases the volume.
 - Turn to the right : Increases the volume.



Press the [E-COM] button for more than two seconds if E-COM is connected and less than two seconds if E-COM is not connected to cut the volume or restore it instantly.

⚠ Warning

Do not adjust the volume or other controls while driving the vehicle. Do so only while parked in a safe location.

■ Displaying the clock

1. Press the [FUNC] button.
2. Press the [V BND ^] button repeatedly until the clock appears on the screen.

3 Press the [SOURCE] button to switch to [CLOCK ON].

4 Press the [FUNC] button again.



- If the spectrum analyzer display is set to ON, priority is given to the spectrum analyzer display (See Page 35).
- Pressing button [6] during power-off switches ON/OFF of the clock display during power-off.

■ Others

▼ Setting the clock

This receiver uses the 12-hour A.M. / P.M. display notation.

1. Press the [FUNC] button.
2. Press the [CUSTOM] button to switch to the clock adjustment mode.
3. Press the [SOURCE] button to select the hour or minutes to be adjusted.

The blinking one can be adjusted.

4. Press the [∨ BND ∧] button.

[BND ∧] button: Turns the time back.

[BND ∨] button: Turns the time forward.

5. Press the [CUSTOM] button again to return to the normal mode.



To set the clock to 0 minutes, 0 seconds (an exact hour), press the [MODE] button.

For example:

At 3:29: Pressing the [MODE] button returns to 3:00.

At 3:30: Pressing the [MODE] button advances to 4:00.

▼ Enabling the loudness control

The loudness control may be turned on to emphasize low and high frequencies at low volume levels.

Loudness compensates for the apparent weakness of low and high frequencies at low volume by boosting the bass and treble levels.

1. Press and hold the [AUDIO CONTROL] button until the [LOUD ON] display appears on the screen.



To disable the loudness feature, repeat the above procedure to display the [LOUD OFF] indication.

▼ Enabling E-COM feature

1. Press the [E-COM] button for one second.

Pressing the button will switch the E-COM feature on or off.

▼ Adjustment of the front panel angle

1. Press and hold the [OPEN] button for more than two seconds.

While holding the button, the front panel opens regardless of the stage. The operation stops when the limit of adjustable angles is reached.

2. Press the [OPEN] button again for more than two seconds.

The front panel will be completely closed.

▼ Displaying a memo

If memos have been set, a memo recorded corresponding to a number button [1] to [5] appears on the screen when the number button is pressed briefly while the power of the main unit is turned off.

Basic operation

[MODE] button

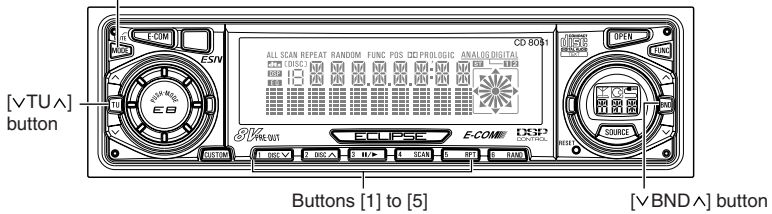

▼ Setting a memo

1. Press and hold any number button for more than two seconds while the power is turned off.

The state shifts to the MEMO setting mode.

2. Press button [1] to select the character type.

Pressing the button will switch types from [ABC] (alphabet characters) to [123] (numeric characters) and then [!&?] (symbols).

3. Press either [V TU ^] to select the position in which to enter the character.

The character will be inserted where the cursor is
Flashing:

[TU ^] button: Moves the cursor to the right.

[TU v] button: Advances the cursor to the left.

4 . Press either button [∨ BND ∧] to select characters.

[BND ∧] button: Advances the character forward in its type.

[BND ∨] button: Moves the character backward in its type.

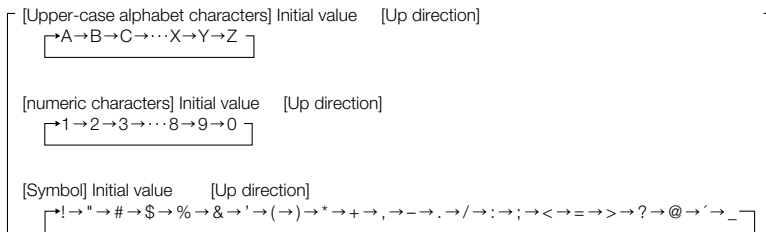

- To change the type of character to be entered, repeat steps 2 and 3.
- A maximum of 30 characters may be entered per memo.
- A maximum of 5 memos may be stored.

5. Press the [MODE] button.

Memo settings are now completed.

▼ Deleting a memo

1. Press the number button corresponding to the memo to be deleted for two seconds while the power is turned off.
2. Press the [MODE] button for more than two seconds.

The memo will be deleted.

▼ Disabling the display

1. Press the [FUNC] button.
2. Press the [∨ BND ∧] button.
Press the button repeatedly until [DISPLAY] appears on the screen.
3. Press the [SOURCE] button to switch ON/OFF of DISPLAY.
4. Press the [FUNC] button again.

▼ Switching the dimming level

The brightness of the display is switched.

1. Press the [FUNC] button.
2. Press the [∨ BND ∧] button until [DIMMER] appears on the screen.
3. Switch the dimming level by pressing the [SOURCE] button.
4. Press the [FUNC] button to cancel the function mode so that the settings are enabled.

▼ Disabling the Tone Control feature

1. Press the [FUNC] button.
2. Press the [∨ BND ∧] button repeatedly until [TONE] appears on the screen.
3. Press the [SOURCE] button to switch ON/OFF.
4. Press the [FUNC] button.
Pressing the button will cancel Function mode.

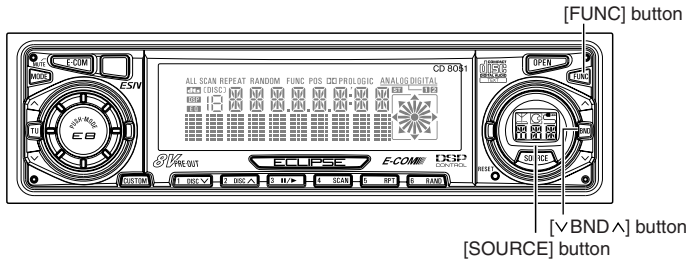

▼ Disabling the Cross Over (F.R) function

Here, the HPF (high-pass filter) to the front and rear pre-outs can be switched ON and OFF.

Since the high-pass filter passes only higher ranges (lower ranges are cut off), efficient playback is enabled by cutting off lower-range elements not needed for the mid to higher range speaker.

1. Press the [FUNC] button.
2. Press the [▽ BND △] button until [CO/F&R OFF] appears on the screen.
3. Press the [SOURCE] button to switch Cross Over (F.R) ON/OFF.
4. Press the [FUNC] button.

Pressing the button will cancel Function mode.

▼ Disabling the Cross Over (NF) function

Here, the LPF (low-pass filter) to the non-fader pre-out can be switched ON and OFF.

Since the low-pass filter passes only lower ranges (higher ranges are cut off), efficient playback is enabled by cutting off mid to higher range elements not needed for a woofer.

1. Press the [FUNC] button.
2. Press the [▽ BND △] button until [CO/NF OFF] appears on the screen.
3. Press the [SOURCE] button to switch Cross Over (NF) ON/OFF.
4. Press the [FUNC] button.

Pressing the button will cancel Function mode.

▼ Switching the spectrum analyzer display

1. Press the [FUNC] button.
2. Press the [\surd BND \wedge] button until [SA] appears on the screen.
3. Switch ON/OFF by pressing the [SOURCE] button.
4. Press the [FUNC] button to cancel the function mode so that the settings are enabled.

▼ Changing the spectrum analyzer's sensitivity

1. Press the [FUNC] button.
2. Press the [\surd BND \wedge] button repeatedly until [SENS] appears on the screen.
3. Press the [SOURCE] button to switch the spectrum-analyzer mode.

Each press of the button changes the sensitivity of the spectrum analyzer.



4. Press the [FUNC] button again.

▼ Switching the level meter display

The display pattern of the indicator like a meter in the right of the display is switched.

1. Press the [FUNC] button.
2. Press the [\surd BND \wedge] button until LEVEL DISP appears on the screen.
3. Switch the level meter display by pressing the [SOURCE] button.

Mode A: Vol level.

Mode B: S meter (radio)/source level (except radio) indicator.

OFF: The indicator display becomes OFF.

4. Press the [FUNC] button to cancel the function mode so that the settings are enabled.

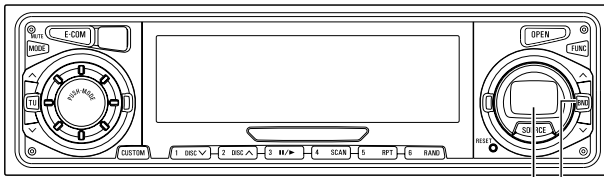

[V BND ^] button
[SOURCE] button

◆ How to operate the CD player

First press the [SOURCE] button to switch to the disc mode. It is assumed here that a CD has already been loaded into the unit.

■ Listening to CDs

1 Press the [SOURCE] button.

This starts CD play.

If an external CD changer is connected, each additional tap of the [V BND ^] button will switch modes from CD changer 1 → CD changer 2 → CD player.

A changer or player with no discs loaded will be skipped.

● Caution ●

- Playback may be intermittent when there is a scratch on a CD or when the recorded side is dirty.
- Only two external CD changers may be connected.

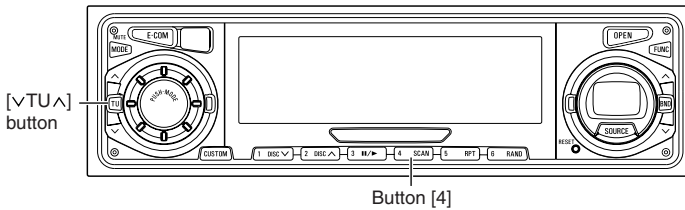

■ Advancing to the next track or returning to the beginning of the track being played

1 ■ Press the [v TU ^] button.

[TU ^] button: Advances to the next track.

[TU v] button: Returns to the beginning of the track being played.



Pressing and holding the [TU ^] button will fast-forward through a track, while pressing the [TU v] button will fast-reverse.

■ Playing the beginning of tracks (SCAN)

1 ■ Press button [4 (SCAN)].

Tapping the button causes the player to move up to the next track and play it for 10 seconds, then move up to the next track and play it for 10 seconds, and so on until the button is tapped again.



To continue playing a desired track, press the button again to stop scanning.

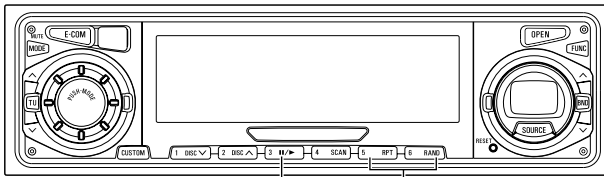

Button [3] Buttons [5] and [6]

■ Repeating the same track (REPEAT)

- 1 ■ Press button [5 (RPT)] to repeat the track being played.
To cancel, press button [5] again.

■ Playing tracks in random order (RANDOM)

- 1 ■ Press button [6 (RAND)] to play the tracks in random order.
To cancel, press button [6] again.



Occasionally the same track happens to be played (selected) two or more times in a row; this is normal operation and is no sign of a problem.

■ Switching a CD to pause / play

- 1 ■ Push button [3 (||▶)].
It pauses playing a CD.
To cancel, press button [3] again.

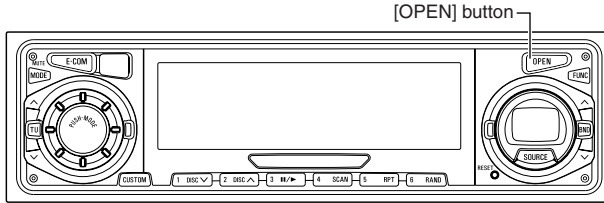

■ Ejecting the disc

1 Press the [OPEN] button for less than two seconds.

The front panel opens fully and ejects the disc.

2 Remove the disc and press the [OPEN] button.

The front panel returns to the angle before the disc ejection. If left alone for 15 seconds after the disc ejection, the front panel returns to the angle before the disc ejection after the BEEP sound.

● Caution ●

- While the ejected disc is still in the slot, pressing the [OPEN] button will insert the disc and start playing it again.
- Do not drive with the front panel open. The panel may cause unexpected personal injury during a panic stop, or the like.
- Do not attempt to close the front panel by hand. Doing so may damage the panel.

How to operate the CD player

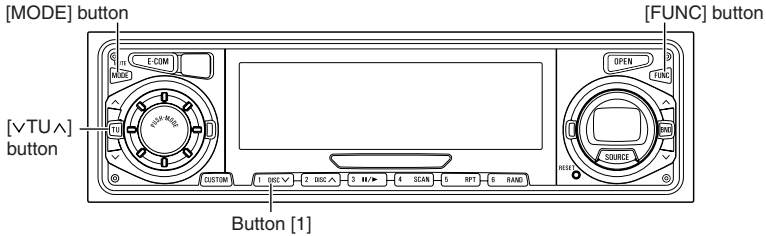

■ Creating a title for a CD

A CD title may be created, attached and displayed for your discs. If external CD changers are connected, a title for a CD will be created in the same way. It is assumed here that the CD to be titled is playing.



No CD text disc can be set.

- 1** ■ Press the [FUNC] button while in the Disc mode.
- 2** ■ Press the [MODE] button.
- 3** ■ Press button [1] to select the character type.
Pressing the button will switch types from [ABC] (alphabet characters) to [123] (numeric characters) and then [!&?] (symbols).
- 4** ■ Press either [v TU ^] button to select the position in which to enter the character.
The character will be inserted where the cursor is flashing:
[TU ^] button: Moves the cursor to the right.
[TU v] button: Advances the cursor to the left.

[MODE] button

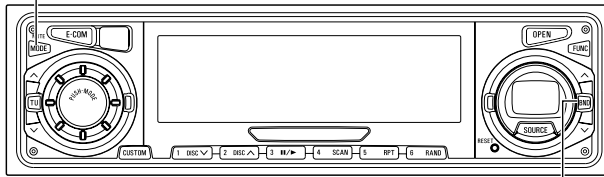

[√ BND ^] button

5. Press either [√ BND ^] button to select characters.

[BND ^] button: Advances the character forward in its type.

[BND √] button: Moves the character backward in its type.

[Upper-case alphabet characters] Initial value	[Up direction]
→A→B→C→...→X→Y→Z	
[numeric characters] Initial value	[Up direction]
→1→2→3→...→8→9→0	
[Symbol] Initial value	[Up direction]
→!→"→#→\$→%→&→'→(→)→*→+→,→-→.→/→:→;→<→=→>→?→@→'→_	



- To change the type of character to be entered, repeat steps 2 and 3.
- A maximum of 10 characters may be entered per title.
- 30 to 100 titles (changeable) can be stored (Use store).
- If the number of discs that can be memorized is exceeded, the information about the disc whose playing time is oldest is deleted.

6. Press the [MODE] button.

The CD title is now memorized.

How to operate the CD player

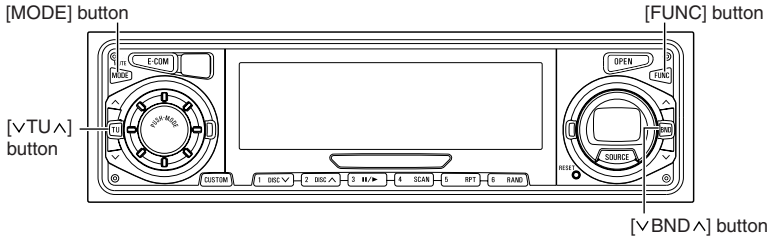

■ Changing a previously set title

If external CD changers are connected, a previously set title for a CD will be changed in the same way. It is assumed here that the disc mode is selected.

- 1** Press the [FUNC] button while in the Disc mode.
- 2** Press the [MODE] button.
The CD title setting mode starts, and all titles are displayed.
- 3** Press either of button [TU] to move the cursor to the position in the title for inserting or changing characters.
[TU] button: Moves the cursor to the right.
[TU] button: Advances the cursor to the left.
- 4** Press either button [BND] to make changes in the character that is flashing.
[BND] button: Advances the character forward in its type.
[BND] button: Moves the character backward in its type.



To leave a space blank, follow these steps.

1. Select and flash the space to be blank.
2. Press the [BND] button to make a blank space flashing.
3. Press the [TU] button to move.

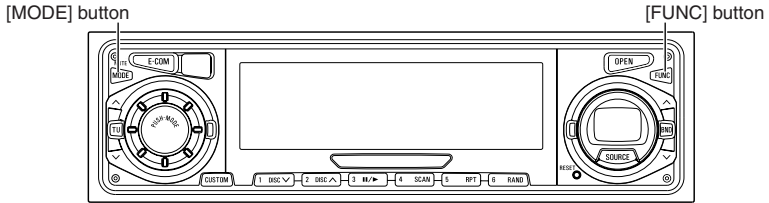

- 5** ■ Press the [MODE] button.
The CD title entry process is now completed.

■ Deleting a previously created title

If external CD changers are connected, a previously created title for a CD will be deleted in the same way. It is assumed here that the disc mode is selected.

- 1** ■ Press the [FUNC] button while in the Disc mode.
- 2** ■ Press the [MODE] button.
The CD title being played at this point will be deleted.
- 3** ■ Hold the [MODE] button down for more than two seconds.
The title has now been deleted.

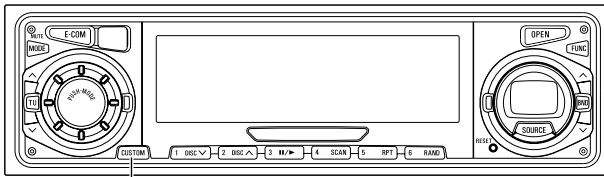

[CUSTOM] button

■ Changing the number of CD titles

The number of CD titles that can be set can be changed by changing the memory allocation. The number of CD titles is fixed for each pattern and the number of tuner bands that can be recorded is also changed at the same time.

1 ■ Press and hold the [CUSTOM] button for more than two seconds.

Each time the button is pressed for more than two seconds, the following patterns are switched.

MEMORY A (standard)	AM/FM : 1/3, CD title memory : 30 titles
MEMORY B	AM/FM : 2/5, CD title memory : 40 titles
MEMORY C	AM/FM : 1/3, CD title memory : 60 titles
MEMORY D	AM/FM : 2/5, CD title memory : 80 titles
MEMORY E	AM/FM : 3/8, CD title memory : 100 titles

[MODE] button

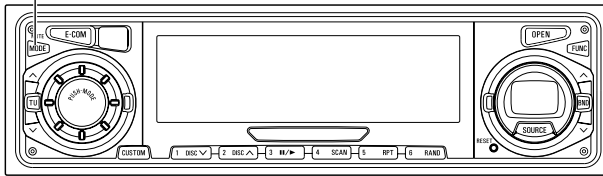

■ Displaying CD text

Only the built-in CD player is supported.

It cannot be displayed with the optional CD changer.

If a CD has a logo shown below, it is recorded a Disc title and track titles, and they can be displayed.



CD text can be displayed by turning OFF the spectrum analyzer display and clock display.

1. Push the [MODE] button.

Pressing the [MODE] button while text is displayed scrolls the display in the order DISC title → TRACK title, and then the display stops with the TRACK title.

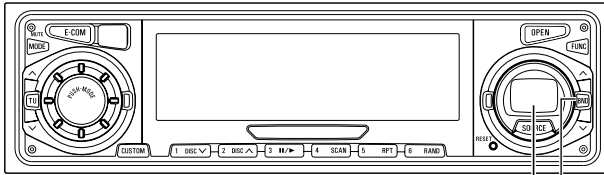

[BND ^] button
[SOURCE] button

◆ How to operate the tuner

First, press the [SOURCE] button to start tuner operation. There are automatic and manual methods for setting stations in memory. The receiver will accept up to 24 stations in memory: six in AM and 18 in FM (6 each for FM1, FM2 and FM3.) (Initial setting)

■ Tuning to a station

1 Tap the [BND ^] button to switch to the desired FM or AM bands.

[BND ^] button: Switch the FM band.

Pressing the button repeatedly switches the FM band in the order of FM1 → FM2...

[BND v] button: Switch the AM band.

Pressing the button repeatedly switches the AM band in the order of AM1 → AM2...

It is also possible to change the numbers of FM and AM bands in a certain combination of them (See Page 56).



When switching the tuner band, switching becomes cyclic in the order of FM1→FM2→FM3→... if the [BND ^] button is used and switching becomes cyclic in the order of AM1→AM2→AM3→... if the [BND v] button is used. Therefore, AM cannot be switched with the [BND ^] button and FM cannot be switched with the [BND v] button. The number of bands that cycle depends on the setting. See "Changing the number of bands (Page 56)".

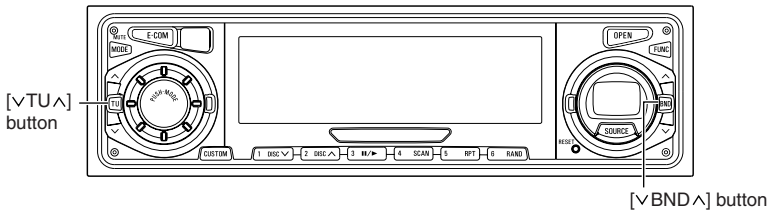

2 Press the [v TU ^] button to tune to a station.

Tap the [v TU ^] button for less than one second to tune to a station manually.

To start searching for a station automatically, hold the button down for more than one second.

[TU ^] button: Tunes to higher frequencies.

[TU v] button: Tunes to lower frequencies.



At times, it may be difficult to maintain optimum reception because the antenna affixed to your vehicle is in motion constantly (relative to the broadcast antenna), encountering continuous variation in the received radio signals' strength. Other factors affecting reception include interference from natural obstacles, sign posts, etc.

■ Entering stations into memory automatically (The automatic preset mode: ASM)

1 Tap the [v BND ^] button to switch to the desired FM or AM bands.

[BND ^] button: Switch the FM band.

Pressing the button repeatedly switches the FM band in the order of FM1 → FM2...

[BND v] button: Switch the AM band.

Pressing the button repeatedly switches the AM band in the order of AM1 → AM2...

It is also possible to change the numbers of FM and AM bands in a certain combination of them (See Page 56).

How to operate the tuner

[MODE] button

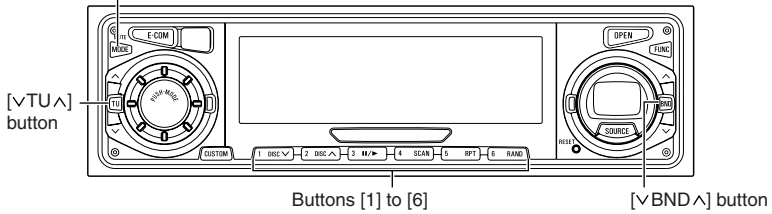

2 Press the [MODE] button for more than two seconds until a beep is heard.

The automatic preset mode starts.

The [ASM] indicator on the screen flashes, and stations are automatically entered in memory under buttons [1] to [6].

These buttons are called preset buttons.



- Press any numbered button to select the station whose frequency is indicated right above the button.
- When a new station is set in memory, the station previously set in memory will be deleted.
- If there are fewer than six receivable stations, the stations set in the remaining buttons will be retained.

Manually setting stations into memory

This section covers the setting of stations in memory under the numbered buttons.

1 Press the [V BND ^] button to switch between FM and AM.

2 Use the [V TU ^] button to tune to the station to be entered in memory.

[MODE] button

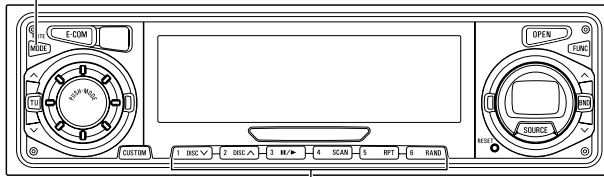

Buttons [1] to [6]

3 Select any button, from [1] to [6], and press it for more than two seconds.

The tuned station is now memorized and set in the button selected. Repeat the procedure to set additional manually tuned stations in memory, in turn, for buttons [1] to [6]. These buttons are called the preset buttons.

● **Caution** ●

If the vehicle's battery is disconnected (for repairs to the vehicle or for removing the receiver), all stations in memory will be lost. In such a case, set stations in memory again.

■ **Preset station scan**

This function enables reception of all the stations in the preset buttons for five seconds each.

1 Press the [MODE] button for less than two seconds.

[P SCAN] will appear at the top of the display, and stations stored under preset buttons [1] through [6] will be played for five seconds each.

2 To stop the preset scan mode at a desired station, press the [MODE] button again.

The receiver will stay tuned to the desired station.

How to operate the tuner

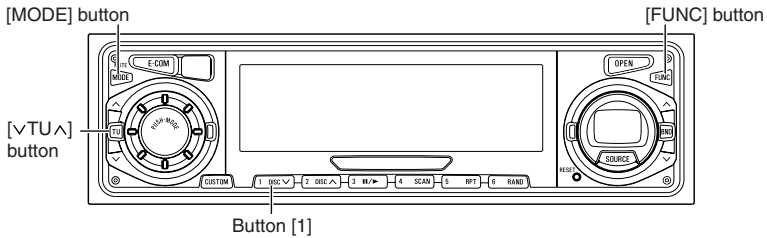

■ Setting a station name

Station name settings can be changed.

- 1** ■ Press the [FUNC] button in the tuner mode.
- 2** ■ Press the [MODE] button for less than one second.
- 3** ■ Press button [1] to select the character type.
Pressing the button will switch types from [ABC] (alphabet characters) to [123] (numeric characters) and then [!&?] (symbols).
- 4** ■ Press either [v TU ^] button to select the position in which to enter the character.
The character will be inserted where the cursor is flashing:
[TU ^] button: Moves the cursor to the right.
[TU v] button: Advances the cursor to the left.

[MODE] button

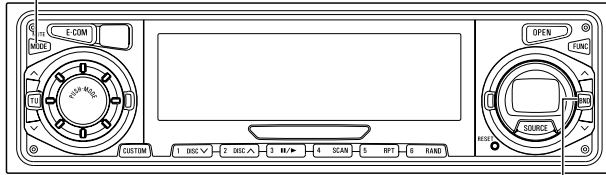

[▽BND△] button

5 Press either [▽BND△] button to select characters.

[BND △] button: Advances the character forward in its type.

[BND ▽] button: Moves the character backward in its type.

[Upper-case alphabet characters] Initial value	[Up direction]
→A→B→C→...→X→Y→Z	
[numeric characters] Initial value	[Up direction]
→1→2→3→...→8→9→0	
[Symbol] Initial value	[Up direction]
→!→"→#→\$→%→&→'→(→)→*→+→,→-→.→/→:→;→<→=→>→?→@→'→_	



- To change the type of character to be entered, repeat steps 2 and 3.
- A maximum of 10 characters may be entered per station name.
- A maximum of 100 station names may be stored.

6 Press the [MODE] button.

The changed station name is now memorized.

How to operate the tuner

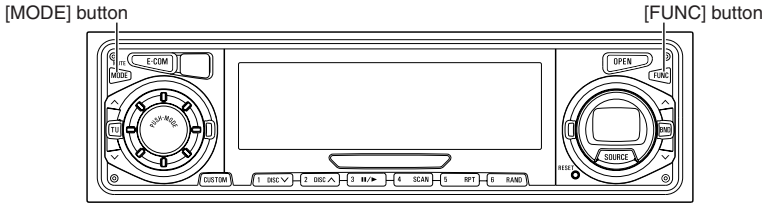

■ Deleting a station name

- 1** ■ Press the [FUNC] button while in the Tuner mode.
- 2** ■ Press the [MODE] button.
The station name that is displayed at this point will be deleted.
- 3** ■ Hold the [MODE] button down for more than two seconds.
The station name has now been deleted.

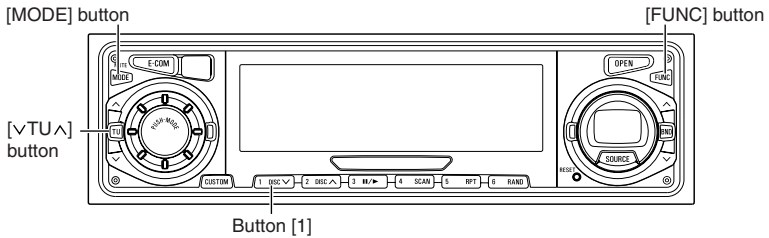

■ Setting a band category

Band category settings can be changed.

- 1** Press the [FUNC] button in the tuner mode.
- 2** Press the [MODE] button for more than one second.
- 3** Press button [1] to select the character type.
Pressing the button will switch types from [ABC] (alphabet characters) to [123] (numeric characters) and then [!&?] (symbols).
- 4** Press either [v TU ^] button to select the position in which to enter the character.
The character will be inserted where the cursor is flashing:
[TU ^] button: Moves the cursor to the right.
[TU v] button: Advances the cursor to the left.

How to operate the tuner

[MODE] button

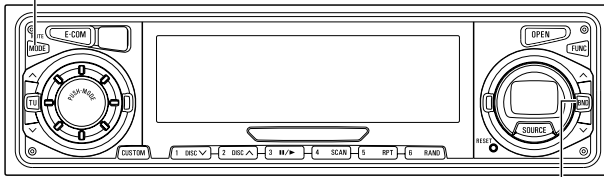

[BND ^] button

5 Press either [BND ^] button to select characters.

[BND ^] button: Advances the character forward in its type.

[BND v] button: Moves the character backward in its type.

[Upper-case alphabet characters] Initial value	[Up direction]
A → B → C → ... → X → Y → Z	
[numeric characters] Initial value	[Up direction]
1 → 2 → 3 → ... → 8 → 9 → 0	
[Symbol] Initial value	[Up direction]
! → " → # → \$ → % → & → ' → (→) → * → + → , → - → . → / → : → ; → < → = → > → ? → @ → ' → _	



- To change the type of character to be entered, repeat steps 2 and 3.
- A maximum of 10 characters may be entered per title.

6 Press the [MODE] button.

The changed band category is now memorized.

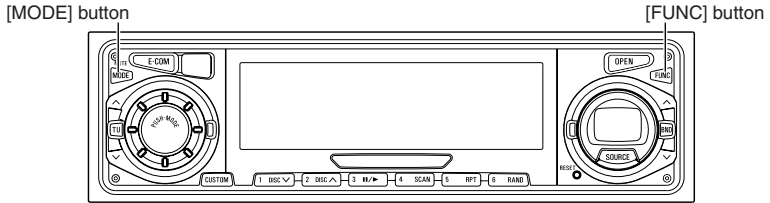

■ Deleting a band category

- 1** ■ Press the [FUNC] button while in the Tuner mode.
- 2** ■ Press the [MODE] button for more than one second.
The category that is displayed at this point will be deleted.
- 3** ■ Hold the [MODE] button down for more than two seconds.
The band category has now been deleted.

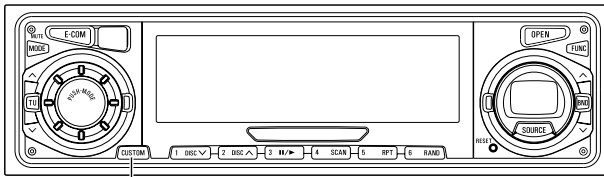

[CUSTOM] button

■ Changing the number of bands

The number of bands can be changed by changing the memory allocations. The number of bands is fixed for each pattern and the number of CD titles that can be set is also changed at the same time.

1 ■ Press and hold the [CUSTOM] button for more than two seconds.

Each time the button is pressed for more than two seconds, the following patterns are switched:

MEMORY A (standard)	AM/FM : 1/3, CD title memory : 30 titles
MEMORY B	AM/FM : 2/5, CD title memory : 40 titles
MEMORY C	AM/FM : 1/3, CD title memory : 60 titles
MEMORY D	AM/FM : 2/5, CD title memory : 80 titles
MEMORY E	AM/FM : 3/8, CD title memory : 100 titles

■ FM reception characteristics

In general, FM has much better tonal quality than AM. However, FM and FM stereo reception encounter several characteristic problems not encountered with AM. FM is more difficult to receive than AM in a moving vehicle. The following are explanatory notes on what to expect from FM reception and on how to get satisfactory performance.

1. FM RECEPTION DIFFERS FROM AM

A characteristic of transmitted signals is that lower frequencies travel further. FM frequencies are much higher than AM's (similar to a ray of light): they won't bend but they will reflect. Often, they will be interrupted by tall buildings, mountains, etc., taking direct and indirect paths to your vehicle's antenna. The distance at which FM stations can be received satisfactorily is usually not nearly as far as that which AM stations can be received.

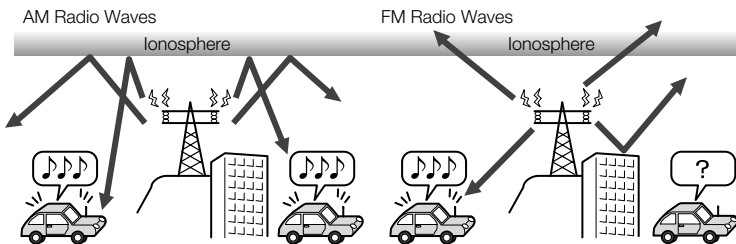

2. FADING OUT

In weak signal or "fringe" reception areas, FM stations may fade out completely, or fade in and out. When driving in weak signal areas, such as near hills, through valleys or tunnels, among tall buildings, etc., you may encounter unusual noise interference. THIS IS NOT A TUNER PROBLEM. In this case, you can only wait until you are in a better reception area, tune to a stronger station, or reduce the treble level.

3 RECEPTION AREA OF FM BROADCASTS

A home receiver can catch weak FM stereo signals through the use of a tall, directional or ultra-sensitive antenna. In a moving vehicle, the area for good reception is limited because of varying conditions encountered while driving, including the types and heights of broadcast antenna structures, signal strength, engine noise, etc. For best reception with manual antenna, extend the antenna mast as far as possible.

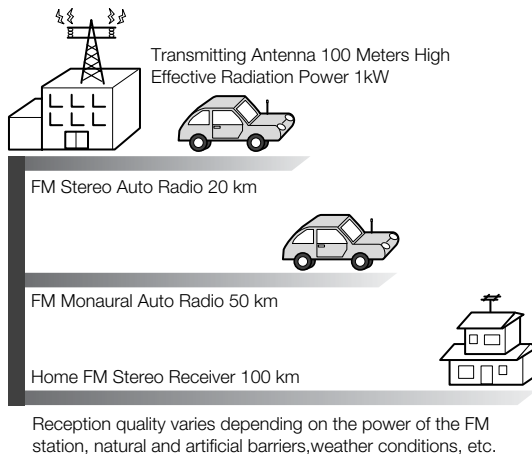

4. MULTIPATH

The reflection characteristics of FM waves cause another problem called multipath—FM wave signals reflecting off of buildings, mountains, etc. When the antenna receives direct and reflected waves at the same time, distortion of sound in the treble range often occurs, such as static or harsh-sounding voices. THIS IS NOT A TUNER PROBLEM. Only moving to another area with a clearer signal path can remedy the situation.

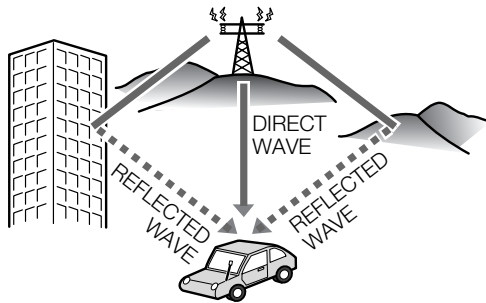

◆ **How to use the NOB remote control**

Precautions in use of the remote control

- Be careful when handling the control, especially because it is small and light. Dropping or striking it hard may damage it, wear out the battery or cause a malfunction.
- Keep the remote control free of moisture, dust and water. Do not subject it to shock.
- Do not place the remote control unit where it will get hot, such as on the dashboard or near a heater vent. Allowing the remote control unit to overheat may warp its case or cause other problems.
- Do not operate the remote control unit while driving because doing so could cause an accident.
- When using the remote control, point it directly at the remote control light receptor.
- The light receptor may not operate correctly if it is exposed to bright light such as direct sunlight.
- Be sure to press the [SOURCE] button on the main unit for more than two seconds to shut it down before leaving the car, or the car battery may be run down. When the main unit is shut down, the remote control will not work.
- Remove the batteries from the remote control unit whenever it is not to be used for a long time.

Cleaning the remote control

- Use a dry cloth to keep the unit clean. If the remote control unit gets extremely dirty, clean it with a cloth moistened in dilute liquid detergent. Do not use alcohol or thinner; these compounds may damage the finish.
- In no event should benzine or thinner be used. These substances will damage the case or finish.

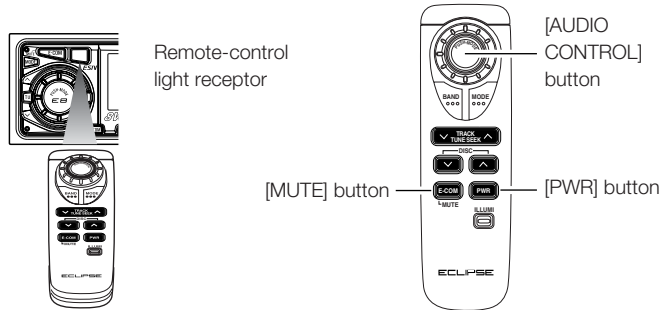

■ Turning the power on/off

When the power is turned on, the state used when the power was turned off such as CD and tuner playing is restored.

1 Press the [PWR] button.

The power turns on or off each time the button is pressed.



When the main unit is shut down, the remote control will not work.

■ Adjusting the audio volume

1 Press the [AUDIO CONTROL] button, and turn it to the left or right.

Each press of the button will switch the audio control modes.

Turn to the right: Increases the volume.

Turn to the left : Decreases the volume.

▼ Cutting the volume instantly (muting):

Press the [MUTE] button for more than two seconds to cut the volume or restore it instantly.



Press the [MUTE] button for more than two seconds if E-COM is connected and less than two seconds if E-COM is not connected to cut the volume or restore it instantly.

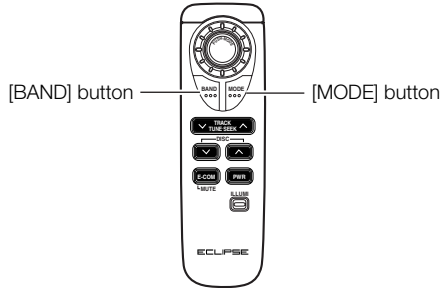

■ Switching playback modes

1 Press the [MODE] button.

Tap the button to switch modes in the following sequence:

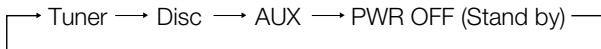

■ How to play the tuner

Select the tuner mode first.

▼ Selecting the FM/AM band

1. Tap the [BAND] button.

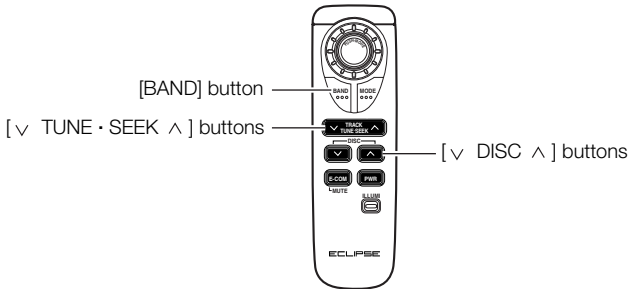

▼ Selecting a station (manually or automatically)

A short tap of the button will allow manual station tuning. Pressing for more than one second will start automatic tuning.

1. Press the [∨ TUNE•SEEK ∧] button.

[∧] button: Tunes to higher frequency stations.

[∨] button: Tunes to lower frequency stations.

▼ Selecting preset stations

A total of six stations may be selected (preset tuning) out of those already set in memory through the main unit. (Refer to “Manually setting stations into memory,” page 48.)

1. Press the [∨ DISC ∧] button.

[∧] button: Selects the next higher number preset button.

[∨] button: Selects the next lower number preset button.

■ How to play CDs

Select the disc mode first.

▼ Switching disc modes

1. Press the [BAND] button.

When one or two CD changers are connected, tap the [BAND] button to change modes from CD player → CD changer 1 → CD changer 2.

The indicator will skip a changer or player that has no

discs loaded.

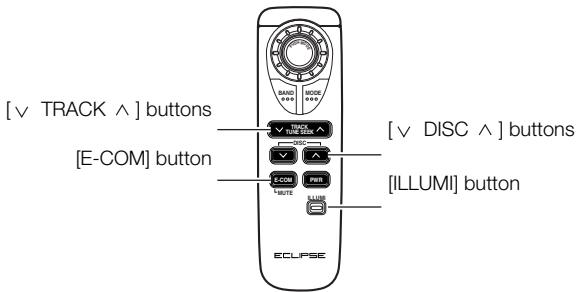

▼ Advancing to the next track or returning to the beginning of the track being played

1. Press the [∨ TRACK ∧] button.

[∧] button: Skips to the next track.

[∨] button: Returns to the beginning of the track being played. (Press repeatedly to move to previous tracks.)



Hold the [∧] button down to fast-forward, or the [∨] button to fast-reverse through the track being played.

▼ Skipping to the next or previous disc

1. Press the [∨ DISC ∧] button.

[∧] button: Selects the next higher number disc.

[∨] button: Selects the next lower number disc.

■ Illuminating the NOB remote control

The buttons of the NOB remote control will be illuminated by pressing the [ILLUMI] button.

■ Enabling the optional E-COM feature

Pressing the [E-COM] button for one second will switch the E-COM feature on or off.

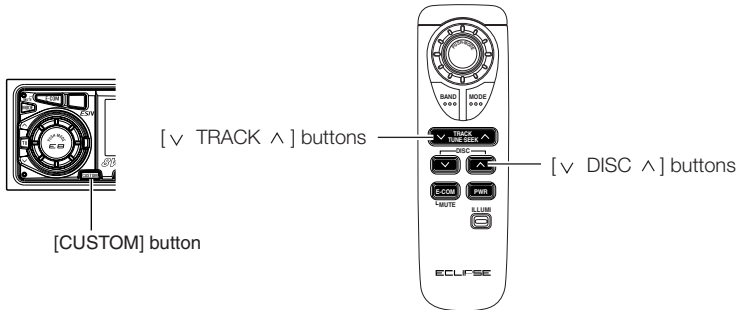

■ Switching the remote control settings

Remote control functions can be switched to the three patterns.

- 1 Press the [CUSTOM] button of the main unit for about one second.
- 2 Each time the button is pressed, the pattern is switched in the order of A, B, and C so that the E-com function can be supported.

REMOTE A : Conventional functions

REMOTE B: [DISC ^] button Repeat

[DISC v] button Answer

[TRACK ^] button Next

[TRACK v] button Previous

Other functions than the above are conventional functions.

REMOTE C: [DISC ^] button Option4

[DISC v] button Option3

[TRACK ^] button Option2

[TRACK v] button Option1

Other functions than the above are conventional functions.

■ Replacing the battery

Warning

To prevent accidents, store batteries out of the reach of children. If a child has swallowed one, consult a doctor immediately.

Use two AA-size batteries.

- 1** ■ Remove the back cover of the remote control unit by gently pressing and sliding it in the direction indicated by the arrow.

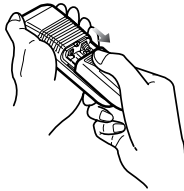

- 2** ■ Install the two batteries provided into the compartment as illustrated inside the compartment.

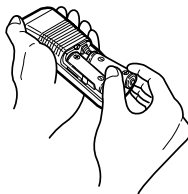

- 3** ■ Return the back cover into place by sliding it in the direction indicated by the arrow.

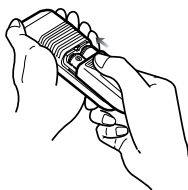

● **Caution** ●

- Be extremely careful not to swallow the battery.
- The battery life is approximately one year. If the remote control unit does not operate correctly or if the button lamp gets dim, replace the batteries.
- Be sure to orient the batteries correctly so that the positive and negative poles match the diagram.
- Do not use one new battery and one old one; use two new batteries.
- Use only two of the same kind of battery.
- If any liquid is seen leaking from the batteries, remove both batteries and dispose of them properly. Thoroughly clean the battery compartment with a dry cloth. Then install new batteries.

How to use an optional Card remote control

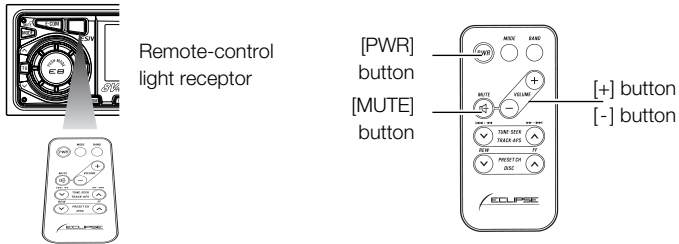

◆ How to use an optional Card remote control

■ Turning the power on/off

When the power is turned on, the state used when the power was turned off such as CD and tuner playing is restored.

1 Press the [PWR] button.

The power turns on or off each time the button is pressed.



When the main unit is shut down, the remote control will not work.

■ Adjusting the audio volume

1 Press the [+] or [-] button.

[+] button: Increases the volume.

[-] button: Decreases the volume.

▼ Cutting the volume instantly (muting):

Press the [MUTE] button to cut the volume or restore it instantly.



Press the [MUTE] button for more than two seconds if E-COM is connected and less than two seconds if E-COM is not connected to cut the volume or restore it instantly.

How to use an optional Card remote control

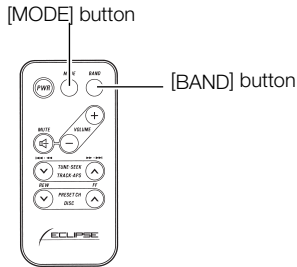

■ Switching playback modes

1. Press the [MODE] button.

Tap the button to switch modes in the following sequence:

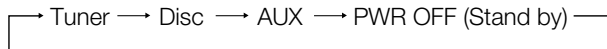

■ How to play the tuner

Select the tuner mode first.

▼ Selecting the FM/AM band

1. Tap the [BAND] button.

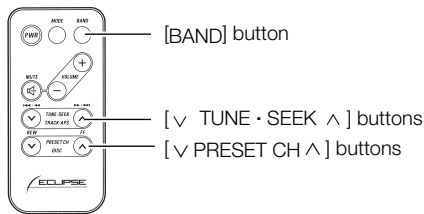

▼ Selecting a station (manually or automatically)

A short tap of the button will allow manual station tuning. Pressing for more than one second will start automatic tuning.

1. Press the [∨ TUNE•SEEK ∧] button.

[∧] button: Tunes to higher frequency stations.

[∨] button: Tunes to lower frequency stations.

▼ Selecting preset stations

A total of six stations may be selected (preset tuning) out of those already set in memory through the main unit. (Refer to "Manually setting stations into memory," page 48.)

1. Press the [∨ PRESET CH ∧] button.

[∧] button: Select the next higher number preset button.

[∨] button: Select the next lower number preset button.

■ How to play CDs

Select the disc mode first.

▼ Switching disc modes

1. Press the [BAND] button.

When one or two CD changers are connected, tap the [BAND] button to change modes from CD player → CD changer 1 → CD changer 2.

The indicator will skip a changer or player that has no discs loaded.

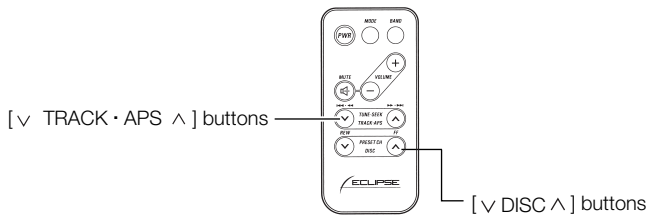

▼ Advancing to the next track or returning to the beginning of the track being played

1. Press the [∨ TRACK • APS ^] button.

[^] button: Skips to the next track.

[∨] button: Returns to the beginning of the track being played. (Press repeatedly to move to previous tracks.)



Hold the [^] button down to fast-forward, or the [∨] button to fast-reverse through the track being played.

▼ Skipping to the next or previous disc

1. Press the [∨ DISC ^] button.

[^] button: Selects the next higher number disc.

[∨] button: Selects the next lower number disc.

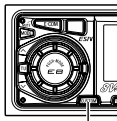

[CUSTOM] button



[v TRACK ^] buttons

[v DISC ^] buttons

■ Switching the remote control settings

Remote control functions can be switched to the three patterns.

- 1** ■ Press the [CUSTOM] button of the main unit for about one second.
- 2** ■ Each time the button is pressed, the pattern is switched in the order of A, B, and C so that the E-com function can be supported.

REMOTE A: Conventional functions

REMOTE B: [DISC ^] button Repeat

[DISC v] button Answer

[TRACK ^] button Next

[TRACK v] button Previous

Other functions than the above are conventional functions.

REMOTE C: [DISC ^] button Option4

[DISC v] button Option3

[TRACK ^] button Option2

[TRACK v] button Option1

Other functions than the above are conventional functions.

■ Replacing the battery

Warning

To prevent accidents, store batteries out of the reach of children. If a child has swallowed one, consult a doctor immediately.

Use one CR2025 battery.

- 1** On the back of the remote control, while pressing the locking knob on the battery slot cover toward your right, pull out the battery carrier with your fingernail.

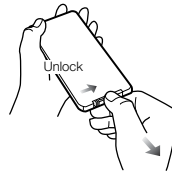

- 2** Remove the old battery, then place the new one in the carrier with the (+) mark facing up.

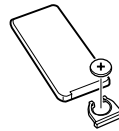

- 3** Push in the carrier until it snaps into place.

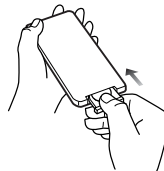

Caution

Be extremely careful not to swallow the battery.

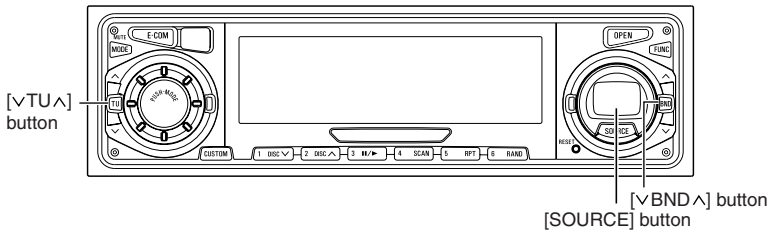

◆ How to operate the receiver with an optional CD changer connected

■ Basic operation

This section covers the operation of an optional CD changer that is connected to the receiver.

To switch from another mode, press the [SOURCE] button.

▼ Listening to a CD

1. Press the [v BND ^] button.

Each press of the button switches the mode from CD Player → CD Changer 1 → CD Changer 2.

▼ Advancing to the next track or returning to the beginning of the track being played

1. Press the [v TU ^] button.

[TU ^] button: Advances to the next track

[TU v] button: Returns to the beginning of the track being played. (Press repeatedly to move to previous tracks.)



Hold down the [TU ^] button to fast-forward, or the [TU v] button to fast-reverse within the disc being played.

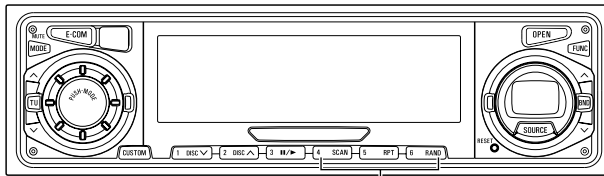

Buttons [4] to [6]

▼ **Playing the beginning of tracks (SCAN):**

1. Press button [4 (SCAN)].

Tapping the button causes the changer to move up to the next track and play it for 10 seconds, then move up to the next track and play it for 10 seconds, and so on, on one CD, until the button is tapped again.

Hold the button until the [ALL SCAN] display appears to play the first 10 seconds of the first track of every CD loaded.

▼ **Repeating the same track (REPEAT):**

1. Press button [5 (RPT)].

Tapping on the button causes the changer to repeat the track currently being played, until the button is tapped again.

Hold the button until the [ALL REPEAT] display appears to repeat all tracks on the CD being played.

▼ **Playing tracks in random order (RANDOM):**

1. Press button [6 (RAND)].

Tapping on the button causes the changer to play the tracks on the currently playing CD in random order.

Hold the button until the [ALL RANDOM] display appears to play tracks from all of CDs loaded in the currently selected changer, in random order.

How to operate the receiver with an optional CD changer connected

[MODE] button

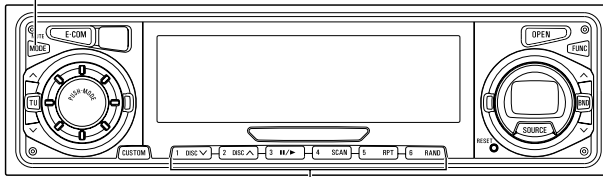

Buttons [1] to [6]



- Occasionally the same track happens to be played (selected) two or more times in a row, but it is no sign of a problem.
- When any of the functions - “Playing the beginning of tracks,” “Repeating the same track” and “Playing tracks in random order” - is selected, a message such as [SCAN], [ALL-SCAN], [REPEAT], [ALL-REPEAT], [RANDOM] or [ALL-RANDOM] is displayed at the bottom of the screen to verify the current function.

▼ Skipping to the next or previous CD

1. Press button [1 (DISC ∨)] or [2 (DISC ∧)].

Button [2 (DISC ∧)]: Selects the next higher number disc.

Button [1 (DISC ∨)]: Selects the next lower number disc.

▼ Specifying a CD to play

A CD of your choice is directly selectable out of the loaded discs.

1. Press the [MODE] button for less than one second.
2. Press a button from [1] to [6].

Buttons	1	2	3	4	5	6
CD	1	2	3	4	5	6
	7	8	9	10	11	12

To select a CD from nos. 7 to 12, press the desired button considerably longer.

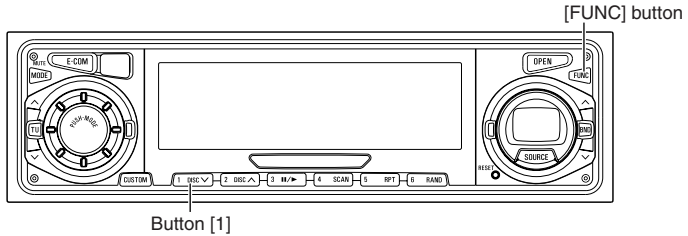

◆ How to operate the receiver with an optional DSP/EQ unit or Digital Sound Processor connected

■ How to operate the DSP functions

The DSP feature adds reverberations to simulate ambience in different types of surroundings (room sizes).

- 1 After pressing the [FUNC] button, tap button [1].

Each tap of the button [1] will switch the room size.

▼ Switching room sizes

1. Tap button [1] to switch room sizes for less than one second.

Six room sizes are available for selection in the following sequence:

1. CONCERT (a concert hall)
2. LIVE (a live house)
3. CATHEDRAL (a church with rich reverberations)
4. STADIUM (an outdoor stadium)
5. CLUB
6. DEFEAT (DSP OFF)

2. Push the [FUNC] button.

This cancels the adjustment mode; the selected room size will now take effect.

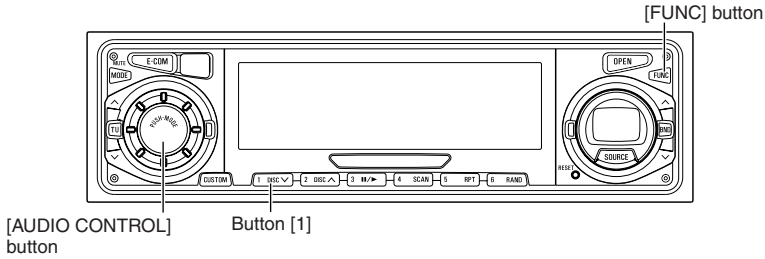

▼ Fine-tuning an individual room-size mode

Detailed adjustments are available in any of the room size modes.

1. After pressing the [FUNC] button, hold button [1] down for more than a second.

The DSP mode starts.

2. Tap the [AUDIO CONTROL] button to select the desired mode of adjustment.

The mode sequence on the button is as follows:

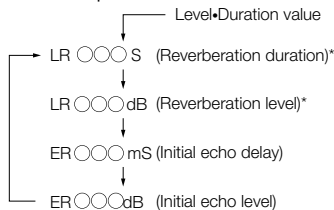

* The level and duration adjustments are available in CONCERT and CATHEDRAL modes only.



- Easy-operation is used in normal audio control mode. (Refer to page 28.)
- The following patterns are preset at the factory:

Button	Indicator display
1	CONCERT
2	LIVE
3	CATHEDRAL
4	STADIUM
5	CLUB
6	CONCERT

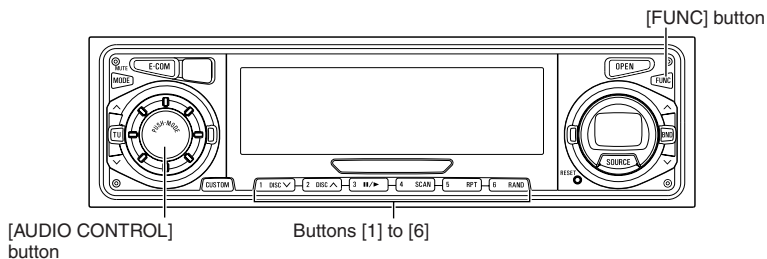

3. Turn the [AUDIO CONTROL] button.

This button adjusts the reverberation level and duration.

Turn to the right : Increases the value.

Turn to the left : Decreases the value.

4. Hold down a button, [1] to [6], for more than two seconds to preset a value.

The preset value is overwritten by the value set using the above steps.

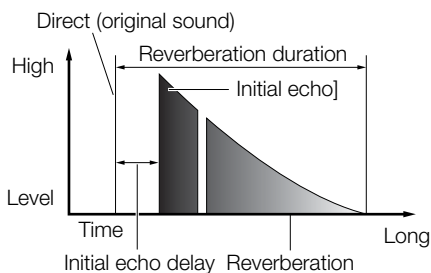

5. Push the [FUNC] button.

The adjustment mode will be canceled and the selected room size will now take effect.

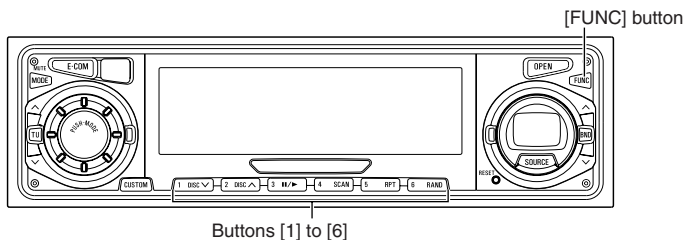

▼ Selecting a preset pattern from memory

Press a preset button to select the room size in memory. The buttons under which room sizes are stored in memory are called preset buttons.

1. After pressing the [FUNC] button, hold button [1] down for more than one second.
2. Press a button, [1] to [6] for less than two seconds.
The room size, as preset in the button, is selected.
3. Press the [FUNC] button to cancel the DSP adjustment mode.

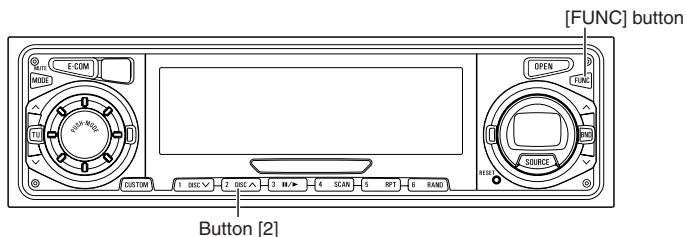

■ How to operate the EQ functions

The EQ functions enable level adjustments of various frequency groups for optimum listening conditions with a specific kind of music or musical instrument.

▼ Switching equalizer modes

1. After pressing the [FUNC] button, tap button [2] for less than one second to switch equalizer modes.

Six kinds of music categories are available for selection in the following sequence:

1. POPS
2. ROCK
3. JAZZ
4. CLASSIC
5. VOCAL
6. NEWS/MOVIE*
7. DEFEAT (EQ OFF)

* If DSP/EQ is connected, "NEWS" appears on the screen. If DIGITAL SOUND PROCESSOR is connected, "MOVIE" appears on the screen.

2. Push the [FUNC] button.

The adjustment mode will be canceled and the selected equalizer mode will now take effect.



The initial EQ settings are factory preset.

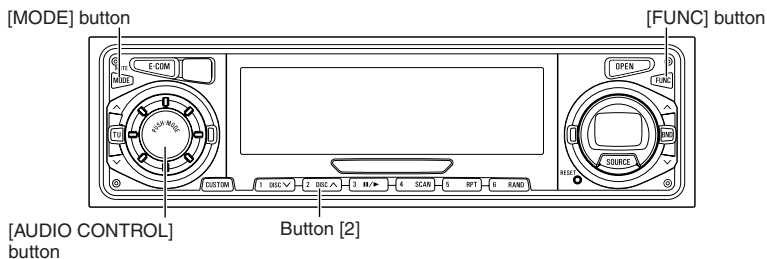

▼ Fine-tuning EQ functions

1. After pressing the [FUNC] button, tap button [2] until the desired equalizer mode is displayed.

2. Hold button [2] down for more than one second.

The EQ adjustment mode starts.

Press the [MODE] button only when a Digital Sound Processor is connected to switch to [FRONT] or [REAR].

Pressing the button repeatedly leads to switching in the order of Front+Rear (not adjustable) → Front → Rear.

3. Tap the [AUDIO CONTROL] button to switch frequencies.

The frequencies will switch in the following sequence:

→ 63Hz → 125Hz → 250Hz → 500Hz → 1kHz → 4kHz → 12kHz →

4. Turn the [AUDIO CONTROL] button to adjust the level.

Right : Increases the value.

Left : Decreases the value.

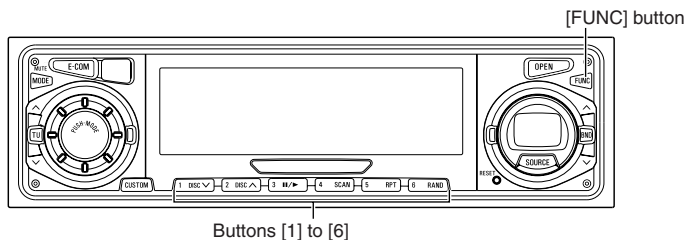

5. Hold down a button, [1] to [6], for more than two seconds to preset a value.

The preset value is overwritten by the value set using the above steps.



When the preset value is changed, the display shows as follows:

USER ○
↑ 1-6 (Preset ch No.)

6. Push the [FUNC] button.

This cancels the adjustment mode. The selected value will now take effect.

▼ Selecting an equalizer mode from memory

Press a preset button to select the equalizer mode set in memory for the button.

The buttons that set equalizer modes in memory are called preset buttons.

1. After pressing the [FUNC] button, hold button [2] down for more than one second.
2. Press the button, [1] to [6] for less than two seconds.
3. Press the [FUNC] button.

The selected equalizer mode will now take effect, and the EQ adjustment mode will be canceled.



Easy-operation is used in normal audio control mode.

How to operate the receiver with an optional DSP/EQ unit or Digital Sound Processor connected

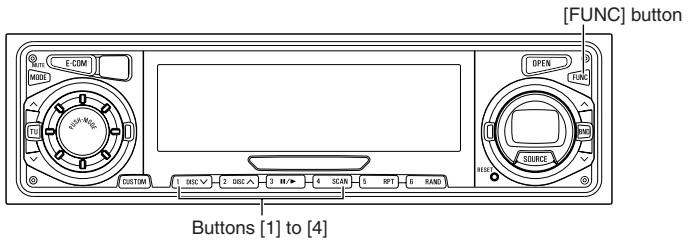

(Refer to page 28.)

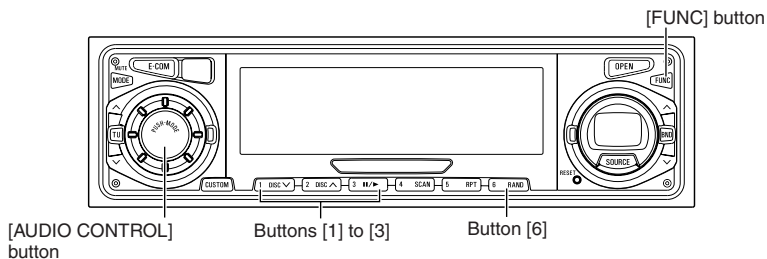

■ How to operate the Digital Sound Processor

Music can be enjoyed more comfortably by modifying the speaker settings.

▼ Setting the speaker size

The size of each speaker is switched.

1. Press the [FUNC] button.
2. Press and hold button [3] for more than two seconds to shift to the setting mode.
3. Press button [1] to shift to the speaker setting mode.
4. Switch the settings by pressing the button corresponding to each speaker.
 - Button [1]: Front speaker
Large/small
 - Button [2]: Rear speaker
Large/small/none
 - Button [3]: Center speaker
Large/small/none
 - Button [4]: Woofer speaker
Yes/no
5. Press the [FUNC] button to return to the setting mode.
6. Press the [FUNC] button again to cancel the setting mode.

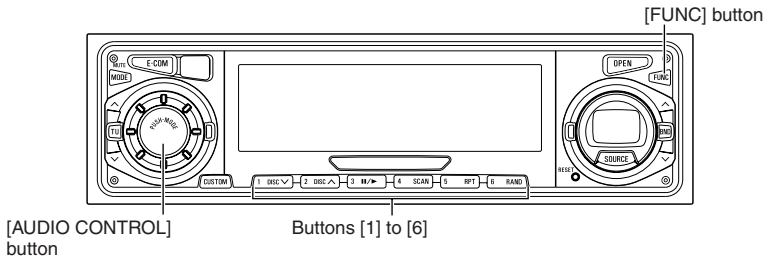

▼ Adjusting the delay (distance) setting speaker

1. Press the [FUNC] button.
2. Press and hold button [3] for more than two seconds to shift to the setting mode.
3. Press button [1] to shift to the speaker setting mode.
4. Press button [6].
The following items are switched in this order:
FR → FL → RR → RL → Ce → Wo
5. Turn the [AUDIO CONTROL] button to the left or right to adjust the distance.
6. Press the [FUNC] button to return to the setting mode.
7. Press the [FUNC] button again to cancel the setting mode.

▼ Adjusting the speaker level

The speaker level is adjusted based on the test tone output from each speaker.

1. Press the [FUNC] button.
2. Press and hold button [3] for more than two seconds to shift to the setting mode.
3. Press button [2] to shift to the speaker level adjustment mode.

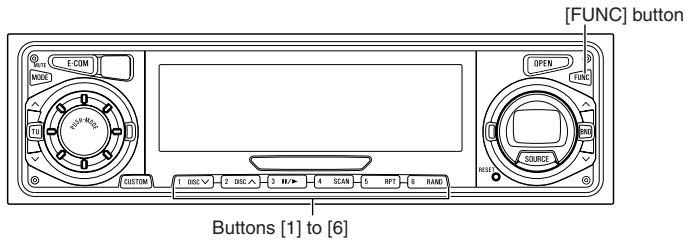

4. Press the [AUDIO CONTROL] button to select the speaker to be adjusted.
5. Turn the [AUDIO CONTROL] button to the left or right to adjust the speaker level.
6. Press the [FUNC] button to return to the setting mode.
7. Press the [FUNC] button again to cancel the setting mode.

▼ Setting the level memory

This is a function to store the speaker level adjusted for each speaker in speaker setting mode.

1. **Set the speaker to a state to be stored.**
2. **Press the [FUNC] button.**
3. **Press button [3] for less than one second.**
The state shifts to the level memory mode.
4. **Press and hold any number button to store settings for more than two seconds.**
The level will be stored.
5. **Press the [FUNC] button.**
The level memory mode will be canceled to return to the normal status.

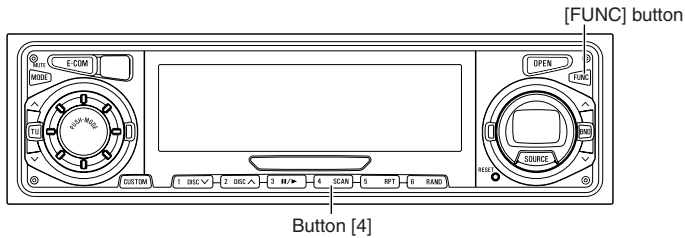

▼ Calling the level memory

The stored speaker level is called.

1. Press the [FUNC] button.
2. Press button [3] for less than one second.
The state shifts to the level memory mode.
3. Press any number button for one second.
The stored speaker level is called.
4. Press the [FUNC] button.

The level memory mode will be canceled to return to the normal status.

▼ Adjusting the center-level blend

This is a function to blend the sound of the center channel with that of the right and left front speakers when the Dolby pro-logic function is ON and this is a function of the Dolby standard for car audio equipment. This function is used to make adjustments for a music listener who is not directly facing the center speaker.

1. Press the [FUNC] button.
2. Press and hold button [3] for more than two seconds to shift to the setting mode.
3. Make adjustments by pressing button [5] or [6].
Button [5]: DOWN
Button [6]: UP
4. Press the [FUNC] button to return to the setting mode.
5. Press the [FUNC] button again to cancel the setting mode.

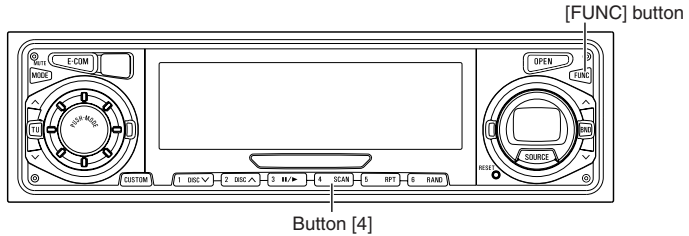

▼ Setting the position mode

If the position of the listener's seat is set, the time required for the sound to reach the listener from the speaker is adjusted so that more natural reverberating orientation can be obtained. In this unit, six positions can be set.

1. Press the [FUNC] button.
2. Each time button [4] is pressed less than one second, the setting is switched in the following order.

If POS ALL-H is selected, the condition of arranging speakers around the listener wherever he is seated is created by optimizing signals output from each speaker for each seating position so that live-music like sound can be enjoyed.

POS RIGHT
POS LEFT
POS FRONT
POS REAR
POS ALL
POS ALL-H
POS DEFEAT

3. Press the [FUNC] button to cancel the function mode so that the settings are enabled.

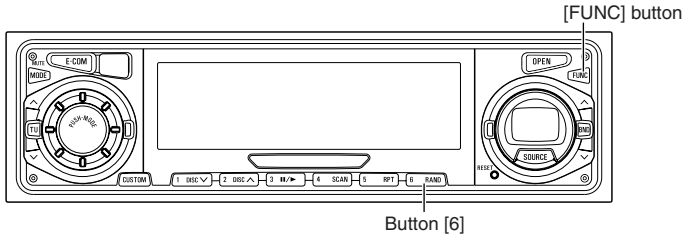

▼ Switching the input channel

If the button is pressed during normal radio reception, or when playing back a CD, the input channel being used at that time will be displayed, and you can then select an external input channel.

1. Press the [FUNC] button.
2. Press button [6] for more than one second.

The setting changes to Digital1 → Digital2 → Digital3 → Analog1 → Analog2 each time the button is pressed.

[DIGITAL 1 / DIGITAL 2 / DIGITAL] or [ANALOG 1 / ANALOG 2] will appear on the display.

Initial settings

Radio mode	: ANALOG 1
DVD player mode	: DIGITAL 1 (optical input)
CD player mode	: DIGITAL 3 (RCA input)
CD changer mode	: ANALOG 1

Use this operation to set the input channels for each mode.

3. Press the [FUNC] button again.

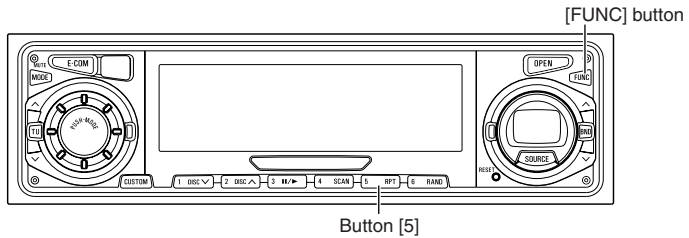

▼ Switching the surround playback mode

1. Press the [FUNC] button.
2. Press button [5].

The surround mode will change in the following order each time the button is pressed.

<For digital input>



Dolby Digital ←————→ Down-mixed 2-channel playback

PCM (2-channel playback) ←————→ Dolby Prologic playback

Do not change the setting if DTS signals are being played.

<For analog input>

Normal 2-channel playback ←————→ Dolby Prologic playback

 or  PROLOGIC will appear on the display.

3. Press the [FUNC] button again.

If you have a question:

.....

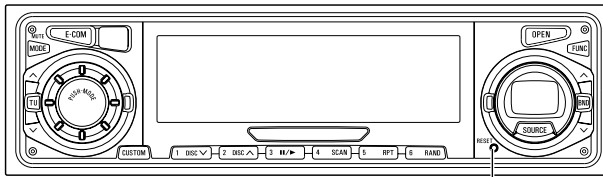

[RESET] button

.....

◆ ***If you have a question:***

First check the items mentioned below before attempting to troubleshoot problems.



● **Caution** ●

If a problem occurs, for instance when the unit does not respond to any button presses, or the display doesn't work correctly, press the [RESET] button using a sharp tool.

Pressing the [RESET] button will delete all the entries from memory. The settings will return to those made at the factory prior to shipment.

■ Displayed information (for troubleshooting)

The information listed in the chart below is displayed to show the status of the tape player and CD changer. Refer to the chart for the appropriate action.

Information Code Table	When "INFO"  flashes on the indicator ↑ Nos.2~7 are displayed.
 Information Contents	Explanation and remedial action to take
2 NO DISC LOADED IN THE MAGAZINE	There is no disc in the magazine or player. Load a disc in the magazine. (Load a music disc.)
3 DISCS ARE DIRTY OR DAMAGED	The loaded disc is dirty or upside down. Check it for proper orientation and verify it is clean.
5 CD CHANGER FAILS MECHANICALLY	<ul style="list-style-type: none"> •The CD changer is inoperative for some reason. Go through the magazine removal procedure. •If a magazine fails to eject, have your dealer fix the problem.
6 WHEN THE CD CHANGER INTERNAL TEMPERATURE IS HIGH (TO PROTECT PICKUP UNIT)	<ul style="list-style-type: none"> •The temperature in the CD changer is too high for operation. Wait till it cools down. •Resume playing after the "High temperature sensed and CD stopped" display disappears. If the CD still cannot play, have your dealer repair it.
7 AN INTERNAL POWER SUPPLY FAILURE IS OCCURRING WITH THE AUTO CHANGER	<ul style="list-style-type: none"> •Turn the ACC off once before turning it on once again to resume the operation. •If the function still cannot be restricted, contact your dealer.
Information Contents	Explanation and remedial action to take
LOAD	CD changer is in the process of verifying the presence of CDs after a magazine has been inserted into the CD changer.
DATA FULL	Indicates that additional title entry has been attempted when the title memory (maximum capacity: 30 ~ 100 titles) of CDs is full.

If you have a question:

Mode	Problem	Causes	Remedial action to take	Refer to page
Common to all	Dead or weak sound	Is the volume control up sufficiently?	Turn up the volume control.	26
		Is the muting function in effect (MUTE)?	Cancel the muting (MUTE) function.	26, 61, 68,
		Is the fader or balance control set far to one side?	Readjust the fader and balance controls to more normal positions.	28
		Other probable causes include broken audio-signal wiring or a faulty speaker.	Have your dealer check the problem.	
	Power does not turn on.	Are too many electrical items installed, causing a lack of power?	Have your dealer check the problem.	
		Other probable causes include a run-down car battery, broken power or interconnection wiring.	Have your dealer check the problem.	
	Frequencies or titles set in memory are deleted.	Has the car battery been disconnected for repair or checked out?	Reenter them into memory.	47, 48
		Are too many electrical items installed and causing lack of available power?	Have your dealer check the problem.	
		Other probable causes include run-down car battery, broken power or interconnection wiring.	Have your dealer check the problem.	
	No guide tone sounds.	Is the guide tone disabled?	Enable the guide tone.	32
	The remote control does not work.	Is the battery low?	Replace battery.	66, 73
		Is the battery installed in reverse polarity?	Reinstall the battery in the correct polarity.	66, 73
		Is direct sunlight hitting the remote control light receptor?	Use the remote control close to the receptor.	
		Other probable causes include a malfunctioning remote control.	Have your dealer check the problem.	

If you have a question:

Mode	Problem	Causes	Remedial action to take	Refer to page
CD	The disc cannot be inserted. The disc is ejected as soon as it is inserted. Or, the disc cannot be ejected. The disc cannot be changed.	Is an extra label or seal applied to the disc?	Do not apply labels or seals to the disc.	13
		Are there rough edges, deformations or damaged areas on the disc?	Try inserting another disc. Removed any burrs. Do not use a deformed or damaged disc.	13
	Sound skips around. Sound is intermittent. Sound is bad in quality.	Is the disc damaged? (scratched, warped, etc.)	Try another disc. Do not play a damaged disc.	12
		Is the disc clean?	Clean the disc.	15
		Is the player mounted at a proper angle? Is the player mounted loosely?	Have your dealer check it out.	
		Are you driving over a rough surface?	Avoid playback while driving over rough surfaces.	10
The disc cannot be ejected.	If unknown	Press the [SOURCE] button a bit longer and then press the [OPEN] button (forced Eject).		

Mode	Problem	Causes	Remedial action to take	Refer to page
Tuner	Receives no stations, or receives static noise.	Is the antenna retracted?	Extend the antenna.	
		Is the tuner correctly tuned to a station?	Tune to a station.	46
		Are you driving outside the service area of your preset stations?	Tune to a local station. (Please note, there may be no local stations servicing the area where you are currently driving.)	46
		Are you operating other equipment with a computer, or a mobile phone, in your vehicle at the same time as your receiver?	Avoid operating such equipment while using the receiver.	
		Other problems may include a loose or disconnected antenna cable, a bad antenna cable or a bad antenna	Have your authorized Eclipse retailer check the problem.	

◆ Specifications

<GENERAL>

Power Supply	14.4 V DC (11-16 V)
Current Drain	2A MAX
Dimensions (W x H x D)	
In-Dash Unit	7" x 2" x 6 - 1/8" (178 x 50 x 155 mm)

<FM TUNER>

Frequency Range	87.75~107.9 MHz (200 kHz step)
Usable Sensitivity	13 dBf
50dB Quieting Sensitivity	21 dBf
Frequency Response	30~15,000 Hz, ± 3 dB
Stereo Separation	38 dB

<AM TUNER>

Frequency Range	530~1,710 kHz (10 kHz step)
Usable Sensitivity	20 μ V

<CD SECTION>

Frequency Response	20~20,000 Hz, ± 3 dB
Wow & Flutter	Below measurable limits
Stereo Separation	73 dB
S/N Ratio (A-weighted)	96 dB
Dynamic Range	95 dB
Total Harmonic Distortion	0.03 %

<AUDIO AMPLIFIER>

Output Level/Impedance	8 V (0 dB CD) / 55 Ω line-out impedance
Tone Action	Bass : ± 10 dB at 60Hz Mid : ± 10 dB at 600 Hz Treble : ± 10 dB at 10 kHz
Loudness	+10 dB at 100 Hz/+6 dB at 10 kHz

◆ **Before installation**

Notes

Be sure to disconnect the vehicle battery's negative terminal before installing the receiver.

■ Components

No.	Item	Q'ty
1	Main unit	1
2	Mounting sleeve	1
3	Side bracket	2
4	Rear bracket	1
5	Bezel	1
6	Bushing	1
7	Self-tapping screw (6 x 16 mm)	2
8	Stud bolt	1
9	Flat Head screw (5 x 8 mm)	4
10	Hex-head bolt (5 x 20 mm)	2
11	Hex nut (5 mm)	2
12	Interconnecting cable	1
13	Remote control	1

◆ **Mounting instruction**

■ **Mounting the main unit**

- 1** Insert the mounting sleeve into the opening in the vehicle console.
- 2** Use a screwdriver or the like to bend the tabs in the mounting sleeve to secure the mounting sleeve.

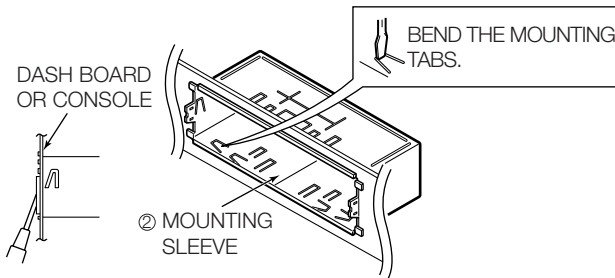

- 3** Attach the side brackets to the main unit using flathead screws.

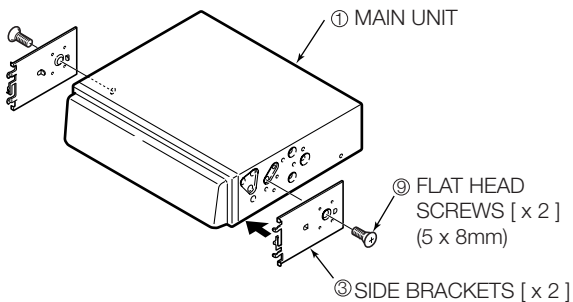

- 4** ■ Mount the stud bolt to the main unit.
- 5** ■ Insert the main unit into the mounting sleeve until it locks in place.
- 6** ■ Fasten the rear of the main unit using either method [A] or [B].

Select method [A] or [B] to suit the interior configuration of the vehicle.

- 7** ■ Install the bezel on the main unit.

[A]

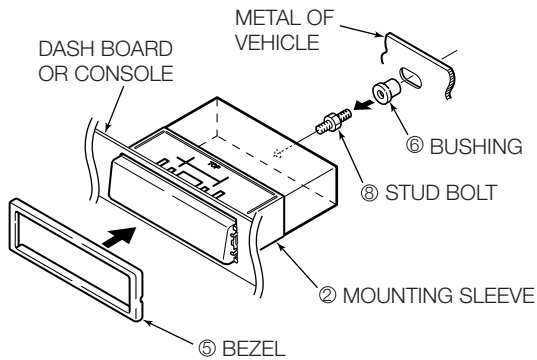

[B]

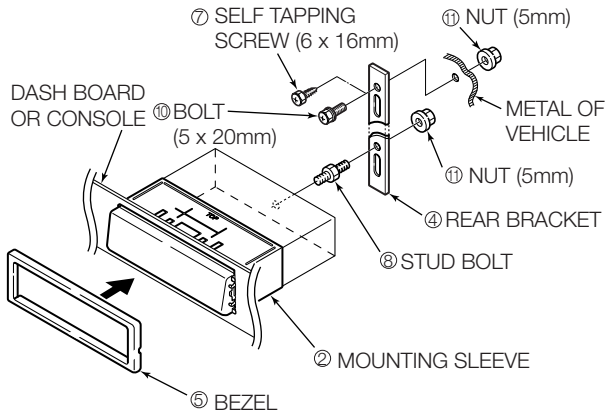

Notes

To prevent unconnected leads from shorting out, insulate them by wrapping their tips with electrical tape. Similarly, insulate the ends of connected leads.

If an external amplifier is to be connected to the receiver, be sure to ground its outside housing to the vehicle body (a metal part).

■ Names of lead wires and destinations (refer to Page 102)

No.	Name	Wire color	Destination
1	ACC	Red	Connect where the power comes on when the ignition is in the ACC position.
2	B+	Yellow	Connect where power is constantly available, regardless of the ignition switch's position.
3	Ground	Black	Connect where good body grounding is available.
4	Antenna power supply	Blue	Connect to the automatic-antenna control terminal of the vehicle.
5	Lamp power supply	Orange/White	Connect to where power comes on when the headlights are turned on.
6	Control power supply	Blue/White	Connect to the control terminal for the external amplifier, etc.
7	E-LAN terminal		Connect to the E-LAN terminal of the CD changer, DSP, etc.
8 & 9	Line-out terminals		Connect to the RCA input connectors of an external amplifier.
10	Line-out terminals (Nonfader)		Connect to the RCA input connectors of a DSP or EQ, or the RCA input connectors of a woofer amplifier.
11	Cellular phone mute	Pink	Connect to the ground output terminal on a mobile phone.
12	Eclipse Commander terminal		Connect to the Eclipse Commander module.
13	Digital out terminals		Connect to digital terminals of the Eclipse Commander module.
14	Line in terminal (for MP3)		Connect to the mini plug (ø3.5) output connector of MP3 unit.

■ System

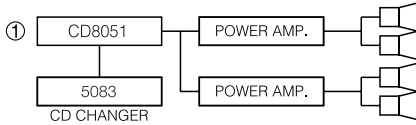

Note:
Adjust the external amplifier's input level.

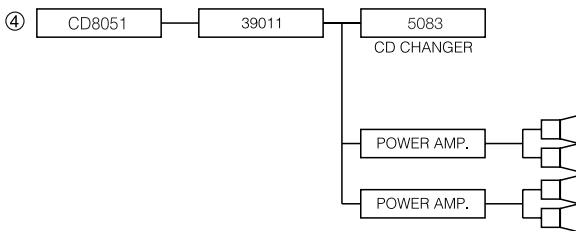
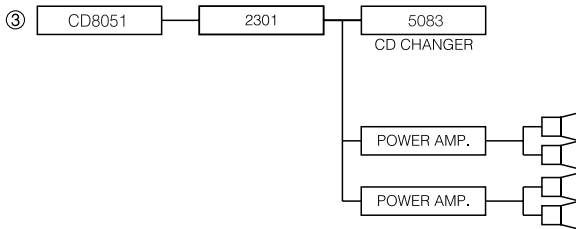
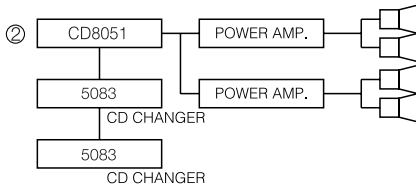

1) CD8051 + 5083 + Power Amplifier

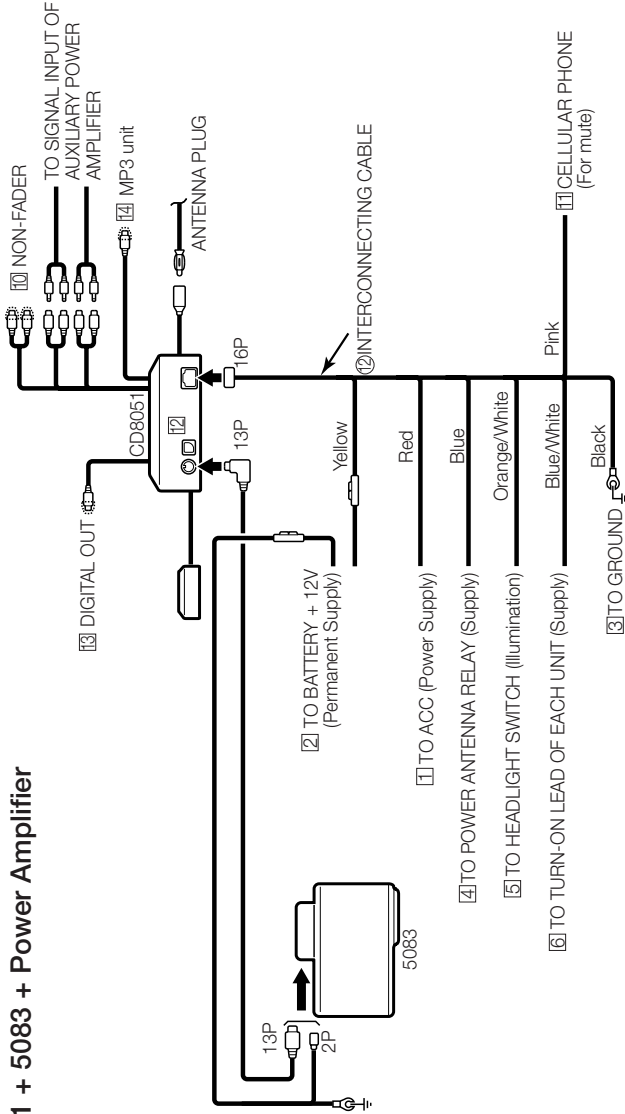

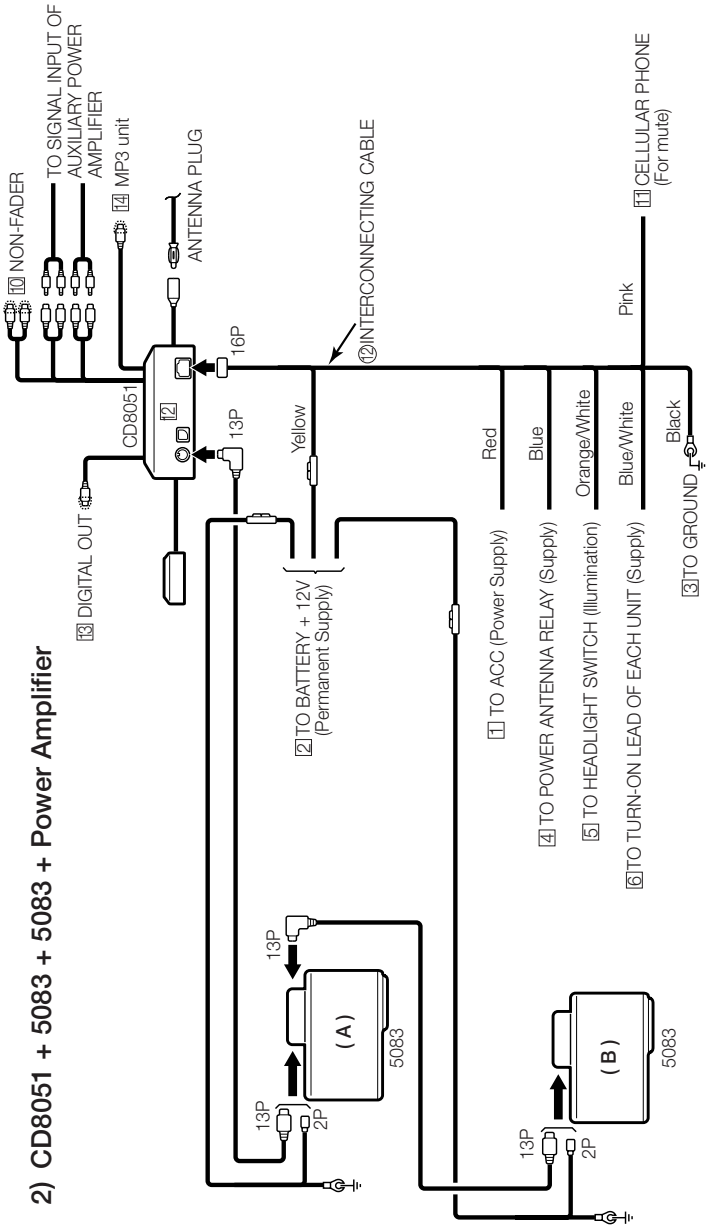

Note : 1. The switch on the back side of CD changer (A) must be set to the "L" position.
 2. The switch on the back side of CD changer (B) must be set to the "H" position.

3) CD8051+ 2301 + 5083 + Power Amplifier

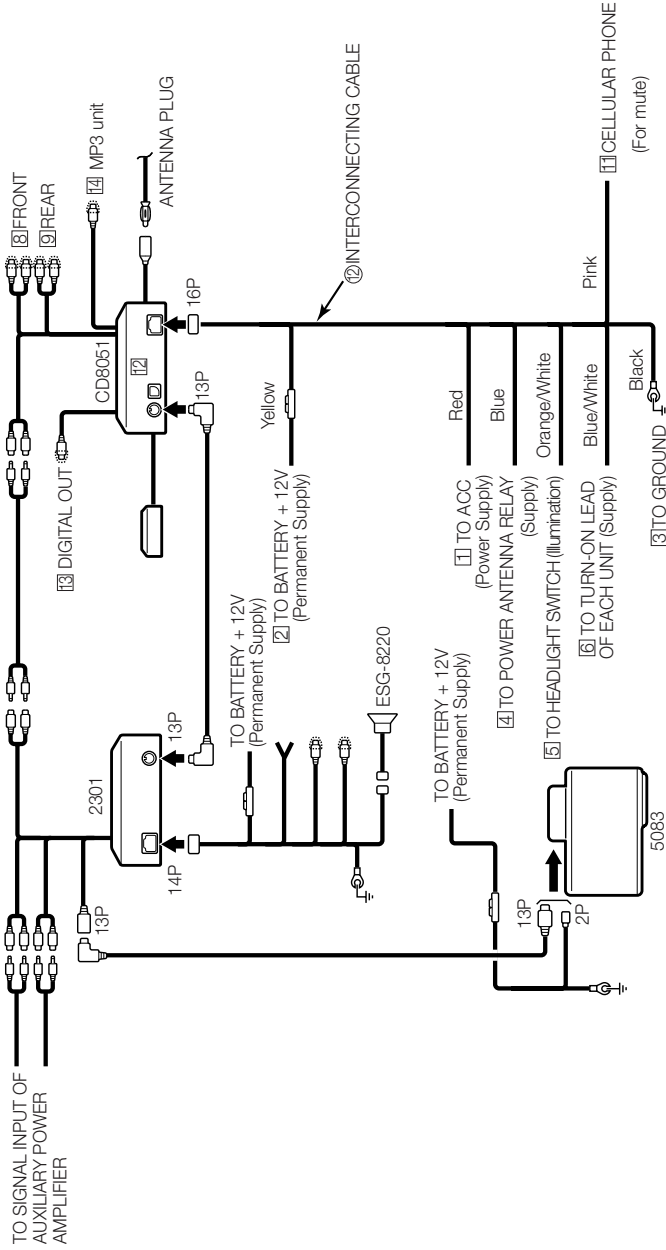

4) CD8051 + 39011 + 5083 + Power Amplifier

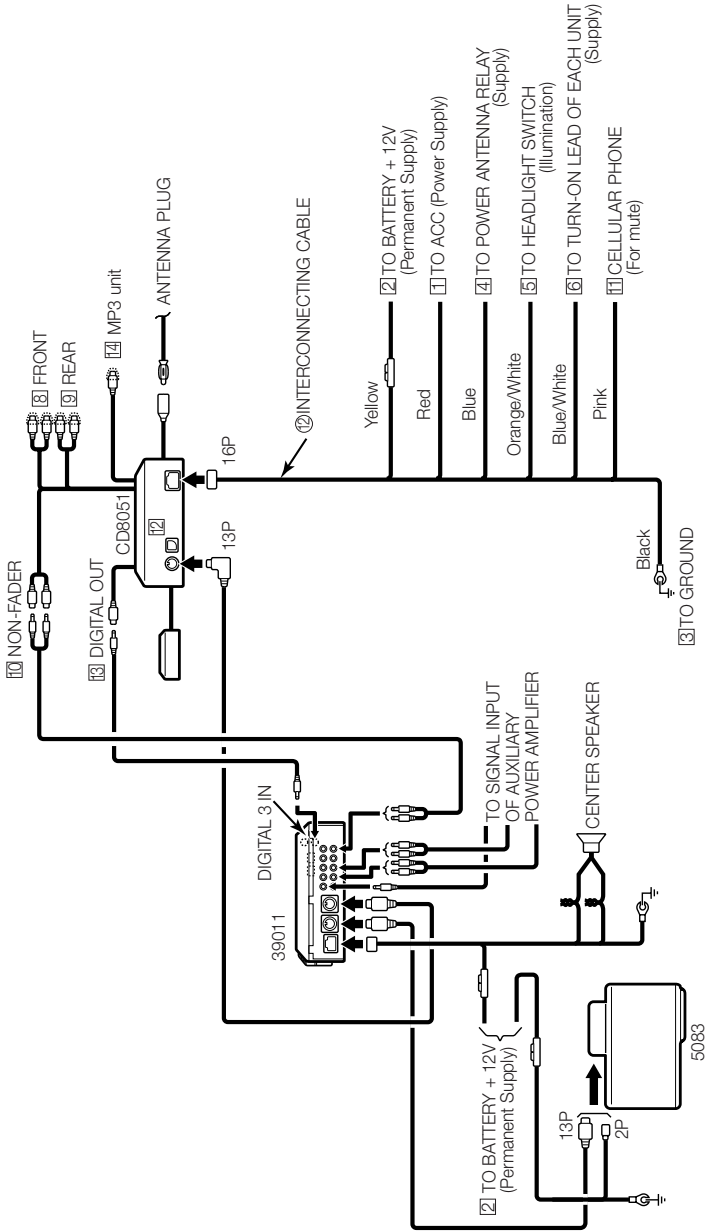

MEMO

IMPORTANT

**RECORD YOUR “KEY
CD” HERE...**

**STORE YOUR “KEY CD”
ALONG WITH YOUR
OWNER’S MANUAL IN
YOUR SOCK DRAWER.**



This device complies with part 15 of the FCC Rules. Operation is subject to the condition that this device does not cause harmful interference.

CUSTOMER NOTICE

Please retain this booklet and write in the serial number of your CD8051 for identification. The serial number is labeled or stamped on the chassis.

Serial No. _____



DIVISION OF FUJITSU TEN CORP. OF AMERICA
19600 SOUTH VERMONT AVENUE, TORRANCE, CA 90502
(310) 327-2151

090001-13940700
0101MT (N.O)

Free Manuals Download Website

<http://myh66.com>

<http://usermanuals.us>

<http://www.somanuals.com>

<http://www.4manuals.cc>

<http://www.manual-lib.com>

<http://www.404manual.com>

<http://www.luxmanual.com>

<http://aubethermostatmanual.com>

Golf course search by state

<http://golfingnear.com>

Email search by domain

<http://emailbydomain.com>

Auto manuals search

<http://auto.somanuals.com>

TV manuals search

<http://tv.somanuals.com>