



DVD Navigation System with 6.5" Wide TFT Display and DVD Multi-Source Receiver

MODEL **AVN51D**

INSTALLATION MANUAL

Be sure to read this installation manual thoroughly prior to installation and making connections. If installation methods or non-standard parts not specified in this installation manual are used, accidents or injury may result.

Professional installation is recommended, contact the place of purchase to schedule an appointment. After reading the owner's manual and the installation manual thoroughly, keep them in a safe place for later reference.

To dealers:

Give this installation manual to the customer after installation and all connections have been completed.

Contents

Before installation	Components	2
	For your safety in using the AVN51D	3
	Installation Diagram	5
Connections	Names and functions of terminals	6
	Connecting the vehicle speed pulse, parking brake, and reverse wires	10
	System connection example	12
Installation	Installing the GPS antenna	13
	Installing the main unit	16



Components

Check that all of the following components are present

Main unit components

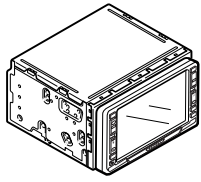

① Main unit x 1

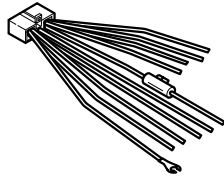

② Interconnecting wires
(Power and front speaker connector)
(10P) x 1

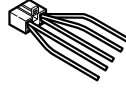

③ Interconnecting wires
(Rear speaker connector)
(6P) x 1

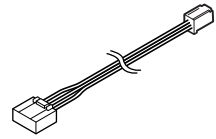

④ Interconnecting wires
(Steering remote control
connector)
(8P) x 1

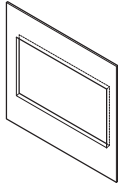

⑤ Panel

x 1



⑥ Hex-head bolt
(Red:M5x8) x 8



⑦ Flat head screw
(Red:M5x8) x 8

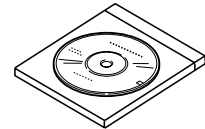

⑧ MAP DVD-ROM x 1

GPS antenna components

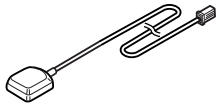

⑨ GPS antenna
x 1



⑩ Waterproof cushion
x 1

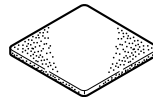

⑪ Ground plate
x 1



⑫ Body protective sheet
x 1

Wiring components

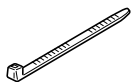

⑬ Wire tie
(for GPS antenna)
x 4



Tip

When installing the main unit, some vehicle models may require the use of items that need to be obtained separately such as a power supply adaptor wire, radio antenna adaptor wire or mounting bracket.

For your safety in using the AVN51D

Warnings and caution signs, illustrated bellow, are posted throughout this manual as well as on the AVN51D. They show safe and correct ways to handle the main unit to prevent personal injury to you and others and avoid damage to property.

Before reading through the manual, take time to read through and learn the important information listed in this section.



Warning

This "Warning" sign indicates a situation in which incorrect handling may result in death or serious personal injury.



Caution

This "Caution" sign indicates a situation in which incorrect handling may result in personal injury or may result solely in damage to property.



Tip

This section contains information that can help to prevent problems and damage to the main unit, and also contain other useful information.

Warning

- Do not install this main unit in locations where it may obstruct the driver's view, or where it may endanger passengers in the vehicle. Otherwise, an accident or injury may result.
- Do not install this main unit in locations where it may interfere with the operation of the steering wheel, shift lever, brake pedal, etc. Otherwise, an accident or injury may result.
- To prevent damage to the vehicle, confirm the locations of hoses, electrical wiring, and the fuel tank prior to drilling holes to install this main unit. Also, take precautions so that the main unit does not interfere, nor come in contact with them. Otherwise, a fire may result.
- When installing this main unit, never use the existing nuts or bolts that secure parts of the fuel tank, or the steering, or braking systems. Otherwise, improper steering, or braking or a fire may result.
- To prevent a short circuit from occurring, disconnect the battery's negative terminal before installing this main unit. Otherwise, an electric shock or injury may result.
- When using an existing nut and/or bolt from the vehicle to ground this main unit, do not use any that secure parts of the steering or braking systems. Otherwise, an accident may result.
- Bundle wires and harnesses with electrical tape or wire ties to prevent them from interfering with moving parts. If they should entangle with the steering wheel, shift lever, or brake pedal, an accident may result.
- Never supply power to another electrical appliance by splicing or tapping into this main unit's power wire. Otherwise, the current capacity of the wire will be exceeded, resulting in a fire or electric shock.
- Never attempt to disassemble or modify the main unit. Otherwise, an accident, fire, or electric shock may result.
- When installing the main unit into a vehicle with a passenger side air bag, do not secure it to the air bag's cover or in places where it may impede air bag deployment. Otherwise, proper air bag operation may not be ensured in the event of an accident, causing injury or death.
- When making holes (example: drilling) be sure to wear protective eyewear. Otherwise, an injury such as loss of eyesight may result.
- Exposed wires must be insulated with electrical tape. Otherwise, a short circuit, fire, or electric shock may result.
- Do not modify this system for use other than that specified herein. Also, do not deviate from the installation procedures described herein; Eclipse will not be held liable for damages including, but not limited to serious injury, death, or property damage resulting from installations that enable unintended operation.
- This main unit is intended for operation in DC 12volt, negative-grounded vehicles only. Never use it in 24-volt vehicles such as heavy trucks or diesel vehicle with cold-region specifications.

Warning

- Do not place the vinyl storage bag over a person's head. It may cause a serious accident or death by suffocation.
- Do not disassemble or rebuild this main unit. Doing so may cause an accident, fire, or electrical shock.
- When it is necessary to replace the fuse, always use a fuse of the correct rating (number of amperes). Use of fuses with higher amperage ratings may cause a fire.
- Do not operate the main unit in a malfunctioning condition, for instance, when the audio does not play. Doing so may result in an accident, fire, or electrical shock.
- If an abnormal situation occurs, such as foreign matter entering or liquid splashing on the main unit, or smoke or a strange odor emitting from the main unit, shut off the main unit immediately and consult the dealer from whom you purchased it. Continued operation may cause an accident, fire, or electrical shock.

Caution

- For best results, this main unit should be installed by a professional installer. Contact the dealer whom you purchased the main unit for an appointment.
- When installing this main unit, be sure to use the supplied mounting hardware. If parts other than those supplied are used, the main unit may be damaged internally, or may not be held in place securely and become dislodged.
- Avoid installing this main unit in places where it may get wet, such as near windows, or in places that are moist or dusty. Presence of liquid, moisture, or dust inside this main unit can cause short circuiting resulting in smoke or fire.
- If this main unit is not connected properly, a short circuit, fire, or accident may occur.
- When routing wires, use precautions to prevent contact of sharp metal parts such as brackets or screw tips. Otherwise, a short circuit, electric shock, fire, or accident may result.
- Play the audio at a moderate volume level that permits you to hear sounds from outside the vehicle. Driving without being able to hear outside sounds may result in an accident.
- This main unit must be operated only as on-board main unit, or it may cause electrical shock or injury.
- Do not play distorted sounds for long periods of time; the speakers may overheat and cause a fire.
- Once installation and wiring have been completed, return the brakes and electrical equipment such as lights, horn, hazard warning lights and turn signal lights to their original places, and check that they operate correctly. If you use the vehicle while any of this equipment is not working correctly, fire, electric shocks or accidents may occur.
- Use supplied wire harness with this main unit. Other manufacturers may use a similar wire harness connector but pin configurations are incorrect for use with Eclipse main units and can damage the main unit. Prior to powering up the main unit, please make sure the main unit is properly grounded with the vehicle chassis. If no ground is available to the chassis, add a ground strap from the main unit to the vehicle chassis to improve the ground.
- Do not use with speakers having 1 to 3 ohms impedance. This main unit is designed to be used with high-powered speakers rated above 50w with impedance rating between 4 and 8 ohms.

Installation Diagram

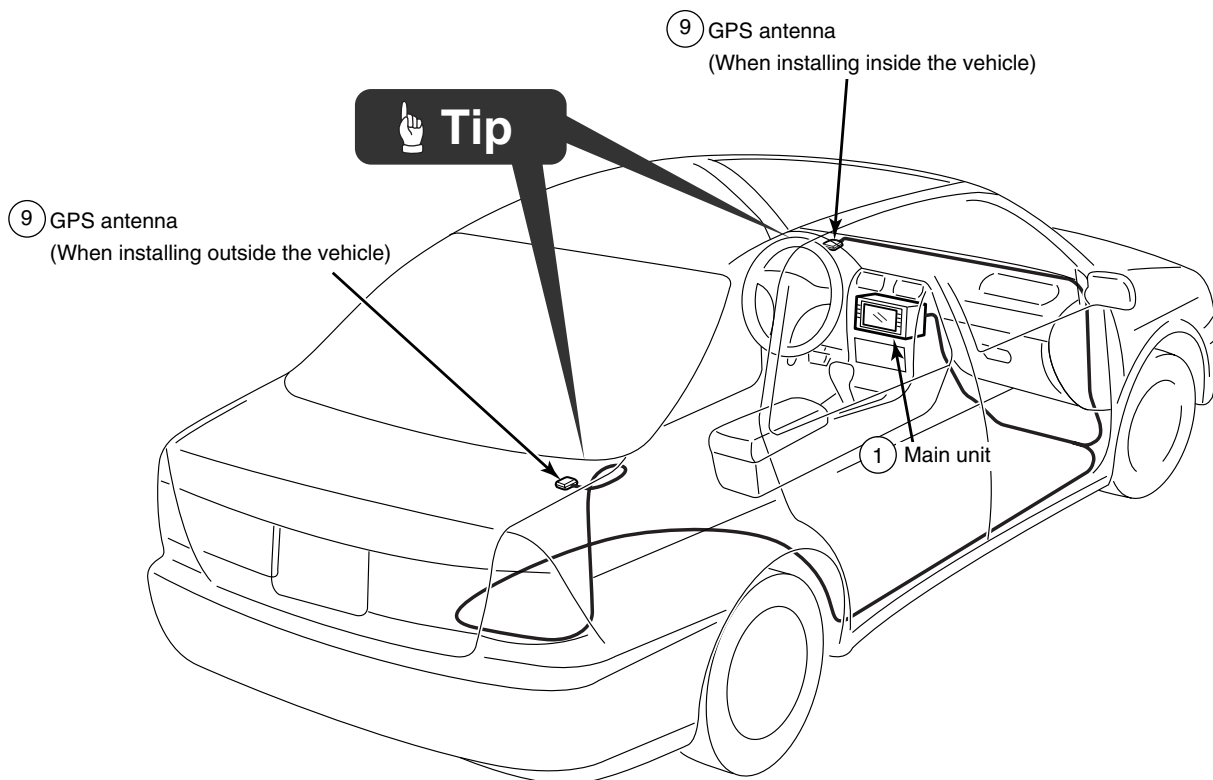

Tip

- If installing the GPS antenna inside the vehicle, the location and the slope of the vehicle's windshield will determine the accuracy of the GPS antenna to receive the GPS signal. If the GPS antenna location inside the vehicle is hindering the accuracy of the GPS antenna, then you may want to install the antenna outside of the vehicle.
- The materials used in front and rear vehicle windows can cause GPS reception sensitivity to drop significantly. If this happens, install the GPS antenna on the outside of the vehicle.

Name and functions of terminals

⚠ Warning

- Never cut the insulation on the power wire or use it to power any other equipment. If the rated current capacity of the power wire is exceeded, fire and electric shocks may result.
- The wires should be secured with tape or a similar securing method to prevent any obstructions while driving. If they get wound or entangled around components such as the steering wheel, shifting lever, or brake pedal, accidents may result.
- If removing the end of the wire to connect to another wire, be sure to wrap PVC tape or a similar wire insulating method around the connection to insulate it. If the connection is not insulated, fire or accidents may result.

⚠ Caution

- Use supplied wire harness with this main unit. Other manufacturers may use a similar wire harness connector but pin configurations are incorrect for use with Eclipse main units and can damage the main unit. Prior to powering up the main unit, please make sure the main unit is properly grounded with the vehicle chassis. If no ground is available to the chassis, add a ground strap from the main unit to the vehicle chassis to improve the ground.
- Do not use with speakers having 1 to 3 ohms impedance. This main unit is designed to be used with high-powered speakers rated above 50w with impedance rating between 4 and 8 ohms.

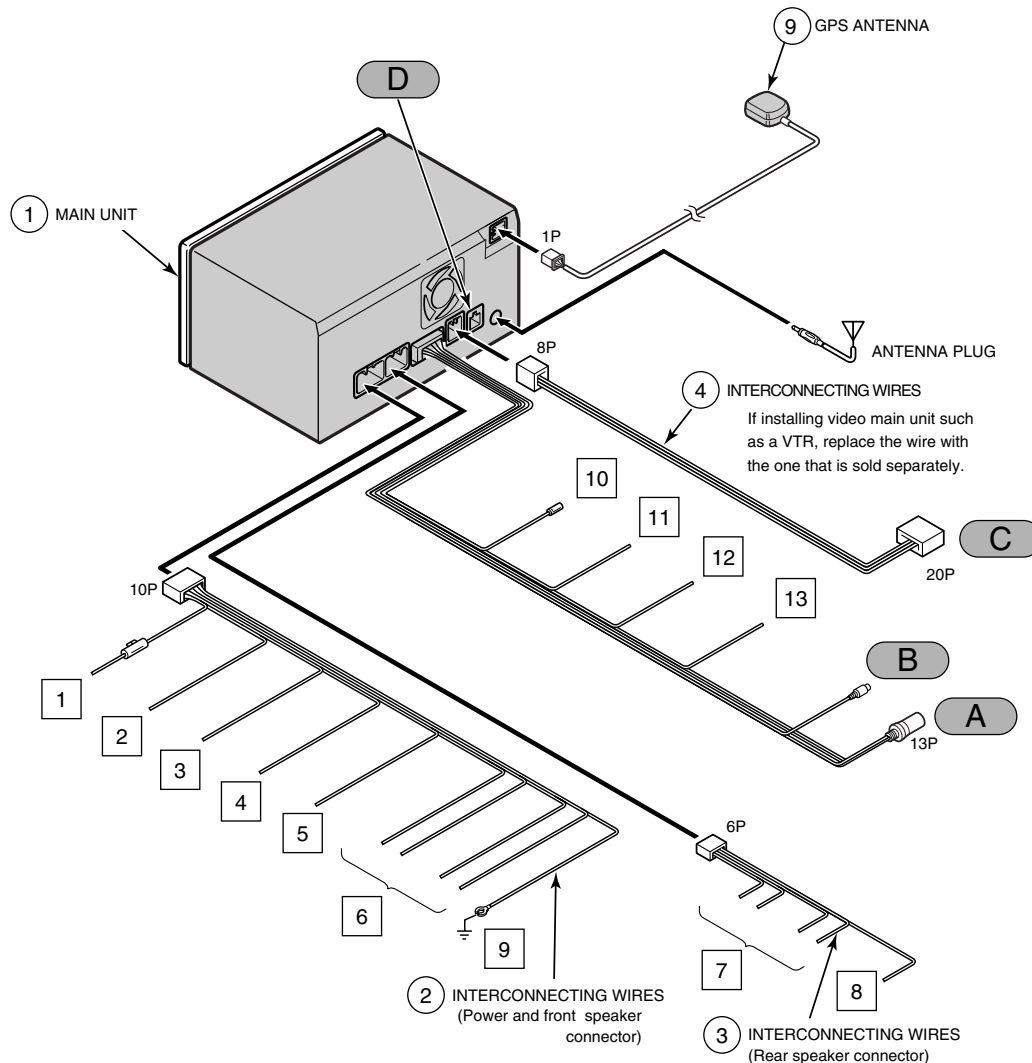

👉 Tip

- Refer to page 7 for details on the wire colors and connection points for Interconnecting wires ②, and ③ and ④.
- Refer to page 8 for details on connection points A, B, and D for the main unit wires and terminals.

◆ Wire colors and connection points for connection wires ② and ③ and ④



Never connect the power supply to the speaker wires (No.6 and No.7), otherwise it will cause damage to the main unit.

1 B+ (Yellow)

Connect where power is constantly available, regardless of the ignition key's position.

2 ACC (Red)

Connect where the power comes on when the ignition is in the ACC position.

3 Illumination power supply (Orange/White)

Connect to where power comes on when the vehicle light switch is turned on.

4 Antenna power supply (Blue)

Connect to the automatic-antenna control terminal of the vehicle.

5 Control power supply (Blue/White)

Connect the control terminal for the external amplifier, etc.

6 Front speaker output wires

Connect to the front speakers.

White: Left +
Gray: Right +

White/black: Left -
Gray/Black: Right -

7 Rear speaker output wires

Connect to the rear speakers.

Green: Left +
Purple: Right +

Green/black: Left -
Purple/Black: Right -

8 No connection (Pink)

9 Ground (Black)

Connect where good body grounding is available.

C

Genuine steering remote control terminal

Connect to the vehicle steering remote control.

Compatible vehicle models for installation : Vehicles with voltage detection-type steering remote control.
Ask your dealer for details.

◆ Main unit connections

10 ACC ON/OFF power supply terminal (blue/white)

If you use this terminal to connect main unit such as an external amplifier, you can still hear the audio guidance from the navigation system even when audio is turned off. Connect it to the control terminal for the external amplifier or other main unit.

A popping noise may be heard when the engine is being started or the ignition switch is at the ON position, but this is normal and is not the sign of a malfunction.

11 Vehicle speed pulse signal wire (Purple/White)

Connect to the vehicle speed pulse signal terminal.

12 Parking brake signal wire (Red/White)

Connect to the parking brake signal terminal.

13 Reverse signal wire (Green)

Connect the reverse signal output of the vehicle to this terminal.

A

E-LAN terminal (13P)

Connect to the E-LAN terminal of the CD changer, etc.

B

VTR output terminal (Yellow)

Connect to the monitor with video input.

D

Back-eye camera external input terminal (4P)

Used with the Eclipse back-eye camera (sold separately).

– Vehicle connections –

 **Tip**

- You will need to purchase the necessary vehicle component adapter wire for the vehicle so that the power supplies can be utilized. (Contact the dealer for further details.)
- Be sure to wrap the connection wires with electrical tape or another insulation method to insulate them.

– Example of using vehicle adapter wires –

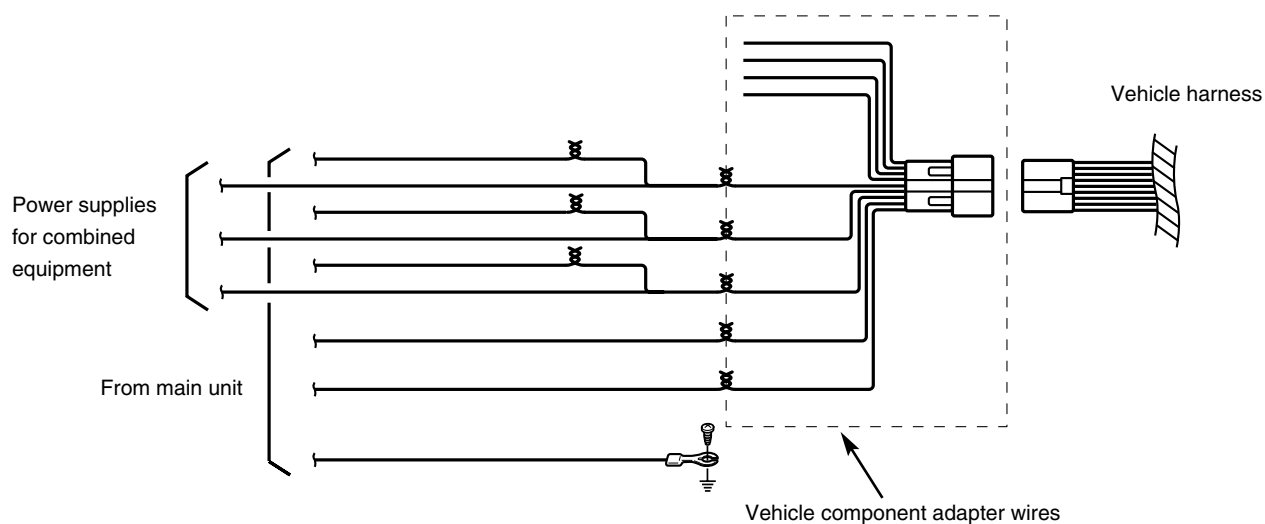

Connecting the vehicle speed pulse, parking brake, and reverse wires

Notes on installation

Warning

- Check the vehicle speed pulse signal, parking brake signal, and reverse signal carefully before making the connections. If the wires are incorrectly connected, accidents or problems with correct operation may result.
- The label on the vehicle speed pulse signal wire contains a protection circuit, so do not cut the wire or remove the protective circuit, otherwise problems with operation may result.
- Bind the wires together with tape so that they do not cause an obstruction while driving. If they become wound or entangled around parts such as the steering wheel, shifting lever, or brake pedal, accidents may result.



Tip

The locations where the vehicle speed pulse signal wire, parking brake signal wire, and reverse wire may vary depending on the vehicle model and grade. Ask the car dealer or your nearest Eclipse dealer for details.

– A connecting point for the vehicle speed pulse signal (example) –



Tip

Always be sure to connect the vehicle speed pulse, otherwise the measurement precision will be greatly reduced.

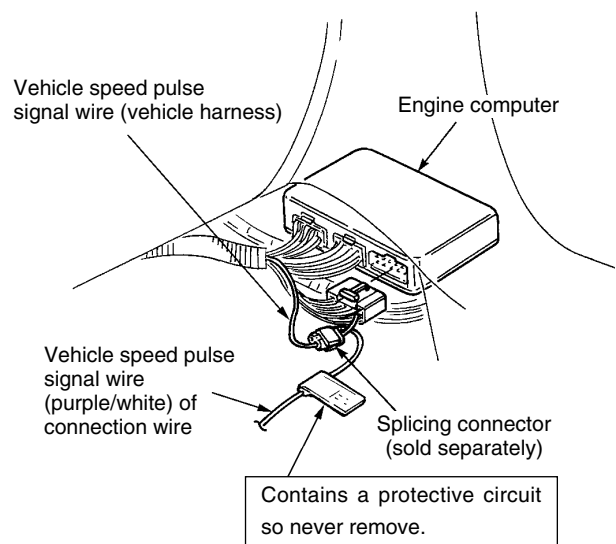

– A connecting the point for parking brake (example) –

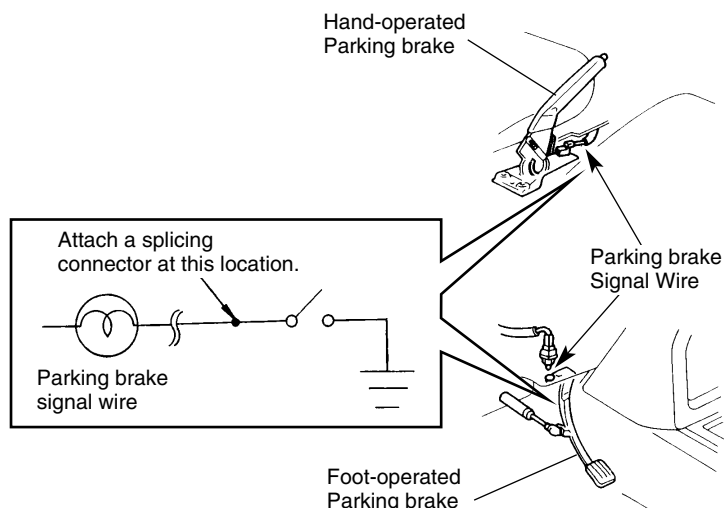

– A connecting point for the reverse signal (example) –

Tip

- Be sure to connect the reverse signal wire. If it is not connected, the vehicle position may be incorrect when the vehicle is reversed.
- Use a circuit tester to confirm that a sensing voltage of 6 V or higher is generated when the vehicle is reversed.

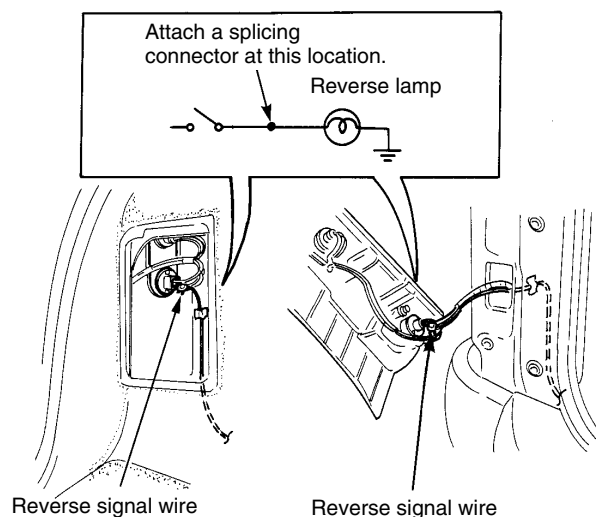

System connection example

⚠ Warning

- Never cut the insulation on the power wire or use it to power any other main unit. If the rated current capacity of the power wire is exceeded, fire and electric shocks may result.
- The wires should be secured with tape or a similar securing method to prevent any obstructions while driving. If they get wound or entangled around components such as the steering wheel, shifting lever, or brake pedal, accidents may result.
- If removing the end of the wire to connect to another wire, be sure to wrap PVC tape or a similar wire insulating method around the connection to insulate it. If the connection is not insulated, fire or accidents may result.

👉 Tip

- Install and connect all of the peripheral units before connecting them to the main unit.
- Do not remove any of the protective caps (RCA, etc.) unless in use.
- Be sure to wrap the connection wires with tape (PVC tape) to insulate them.

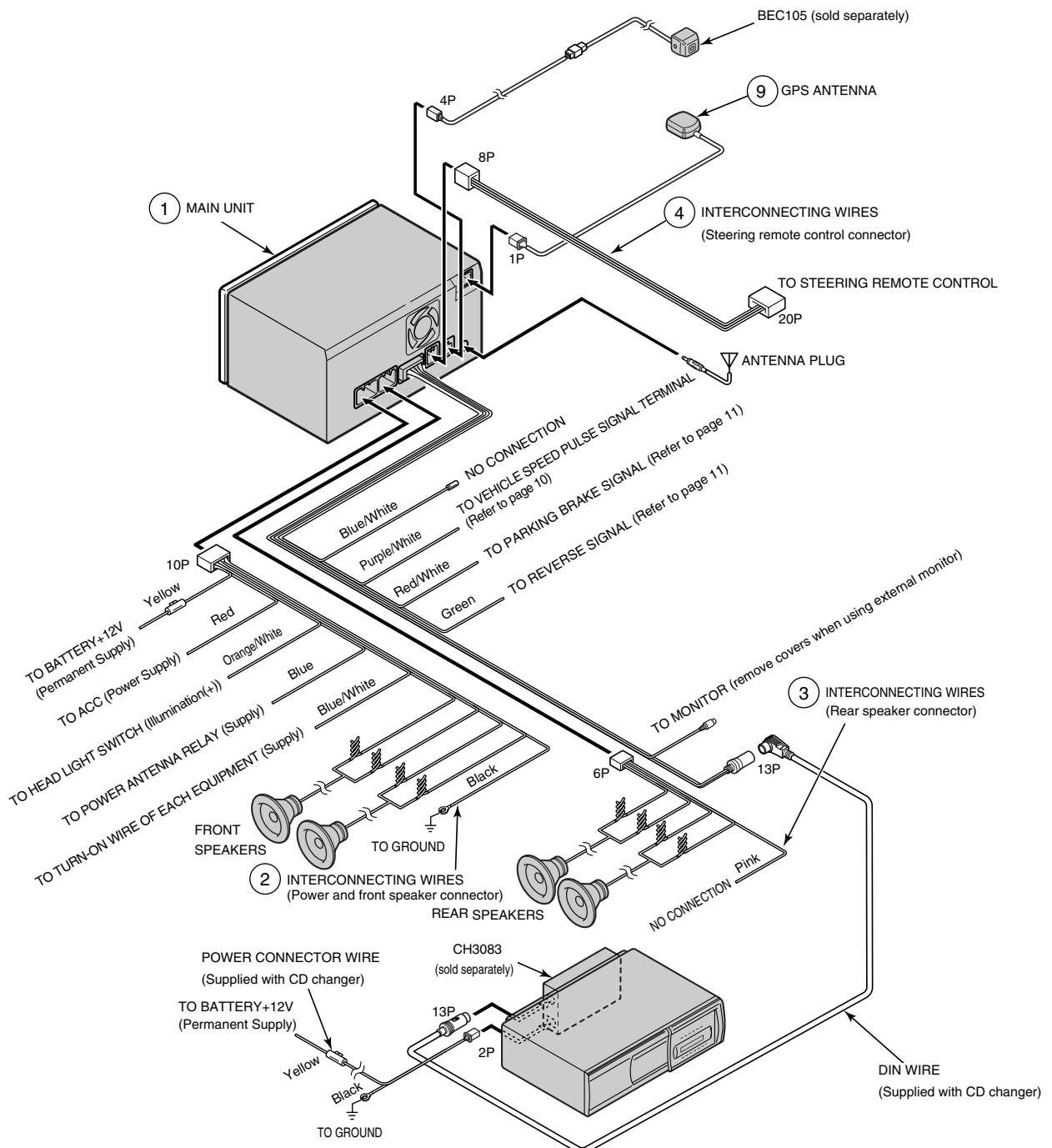

Installing the GPS antenna

Notes on installation

Warning

- The wires should be bound together with tape or a similar securing method (example: wire ties) so that they do not interfere with driving. If it becomes wound or entangled around parts such as the steering wheel, shifting lever, or brake pedal, accidents may result.
- Do not install the GPS antenna where it will obstruct the driver's vision or where it will be an obstacle while driving, otherwise traffic accidents may result.

Tip

- If the vehicle glass is a special type of glass such as heat-reflective glass or bullet-proof glass, be sure to install the GPS antenna outside of the vehicle. If the GPS antenna is installed inside of the vehicle, the reception sensitivity will severely drop and will affect the accuracy of the position measurement.
- If installing the GPS antenna inside the vehicle, be sure it is mounted to the ground plate.
- If installing the GPS antenna inside the vehicle, the location and the slope of the vehicle's windshield will determine the accuracy of the GPS antenna to receive the GPS signal. If the GPS antenna location inside the vehicle is hindering the accuracy of the GPS antenna, then you may want to install the antenna outside of the vehicle.
- The materials used in front and rear vehicle windows can cause GPS reception sensitivity to drop significantly. If this happens, install the GPS antenna on the outside of the vehicle.
- If the attachment surface is a non-plastic surface such as genuine leather, wood panel, or cloth, attaching the antenna may damage the surface finish. Do not attach the ground plate to such surfaces.
- Wipe the installation surface thoroughly so that it is clear of any dirt, moisture, or grease before installing the antenna.
- Do not apply any coatings to the GPS antenna, otherwise it may cause a drop in the reception sensitivity of the antenna.
- Route the GPS antenna wire as far away as possible from TV and radio antennas, and wires, otherwise, it may cause interference with video and audio signals.
- Do not install the antenna in places (such as front pillars and roof panel) that are shielded from the sky.
- The GPS antenna should be installed in a level position where the signals will be as unobstructed as much as possible, such as on the vehicle's roof. Satellite signals cannot be received if the antenna is obscured or obstructed.
- If installing the GPS antenna outside the vehicle, remove the main antenna unit if leaving the vehicle unattended for long periods in order to prevent theft or malicious damage to the antenna.
- Hold the main antenna unit when removing the antenna. Do not pull on the wire, otherwise it may become damaged and result in problems with correct operation.
- If installing the GPS antenna outside the vehicle, remove the main antenna unit when washing the vehicle. (If you wash the vehicle with the main antenna unit still attached, avoid spraying the wire section directly with water so that no water gets inside the vehicle.)
- The magnet that is attached to the GPS antenna is extremely strong. Be sure to note the following when installing the antenna.
 - Do not put the antenna down on the ground or on dirty or dusty surfaces. If iron filings become attached to the magnet, they may cause damage to the vehicle's body.
 - Keep away from watches and the antenna amagnetic cards, otherwise they may be damaged and/or rendered unusable.

– Installation inside the vehicle (example) –

- 1 Choose an installation location on the dashboard which is flat and has a clear view of the sky.

Tip

- Select a location that is at least 20 in. away from the main unit. If this is not done, the GPS measurement precision will drop.
- Be sure to use the ground plate when installing the GPS antenna. If the ground plate is not used, the reception sensitivity will drop and will affect the accuracy of the position measurement.

- 2 Install the ground plate to the dashboard.
- 3 Install the GPS antenna to the ground plate.

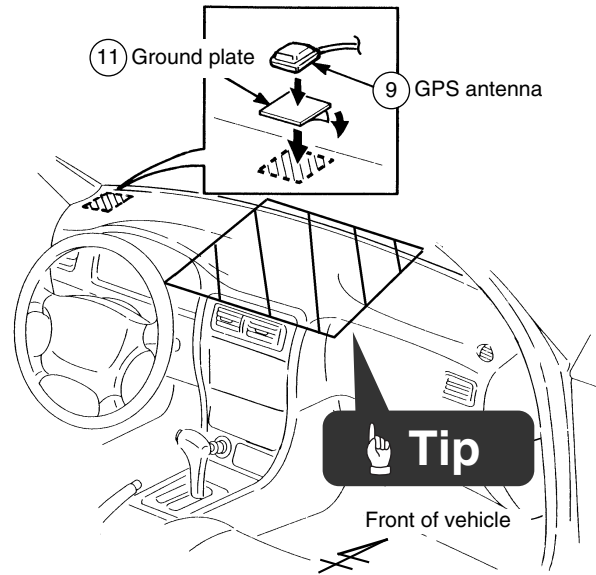

Tip

If installing the GPS antenna inside the vehicle, the installation location and the shape of the vehicle's body will determine GPS accuracy. Accuracy is usually lower when the GPS antenna is installed inside the vehicle.

- 4 Secure the GPS antenna wire .
- 5 Route the GPS antenna wire along the crevice between the front windshield and the dashboard.

Tip

If the GPS antenna wire protrudes from the dashboard, wind tape around it so that it stays securely fixed in the crevice between the front windshield and the dashboard.

- 6 Route the GPS antenna to the main unit's installation location.

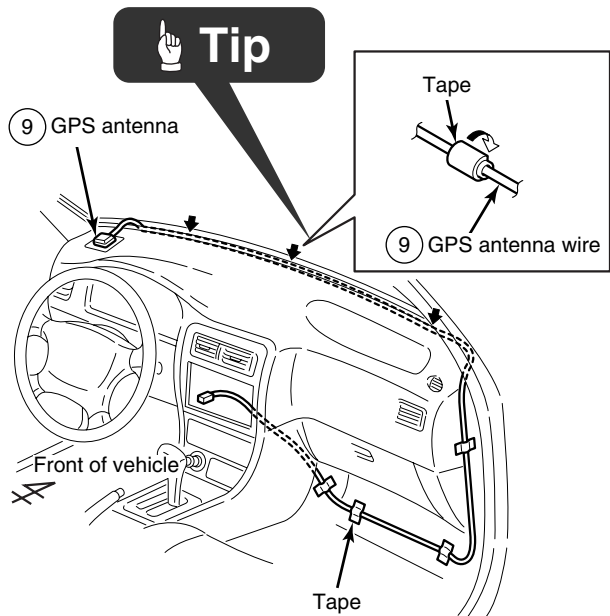

– Installation outside the vehicle (example) –

- 1 Choose an installation location where the GPS antenna can be attached securely.
- 2 Remove the backing paper from the body protective sheet and attach the sheet to the vehicle.
- 3 Install the GPS antenna on top of the body protective sheet.

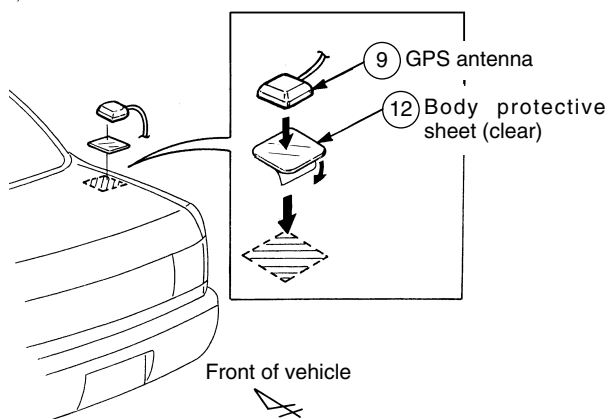

- 4 Route the GPS antenna wire inside the vehicle's trunk and secure it with tape.
- 5 Attach the waterproof cushion so that the GPS antenna wire is flat against the weatherstrip when the trunk lid is closed.



Tip

To aid in sliding the waterproof cushion in finding the desired mounting location, apply plain or soapy water to the waterproof cushion.

- 6 Route the GPS antenna wire while securing it with wire ties.

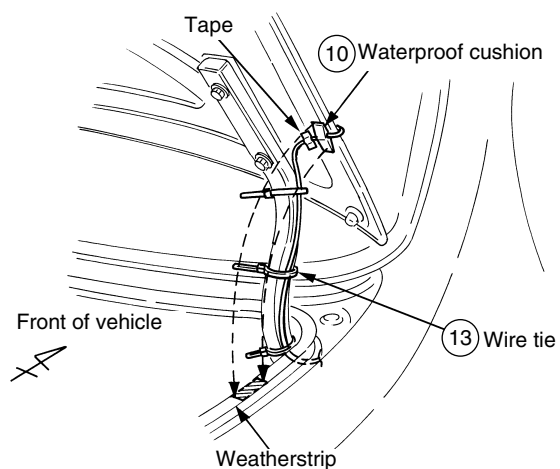

- 7 Route the GPS antenna wire to the main unit while securing it with tape.

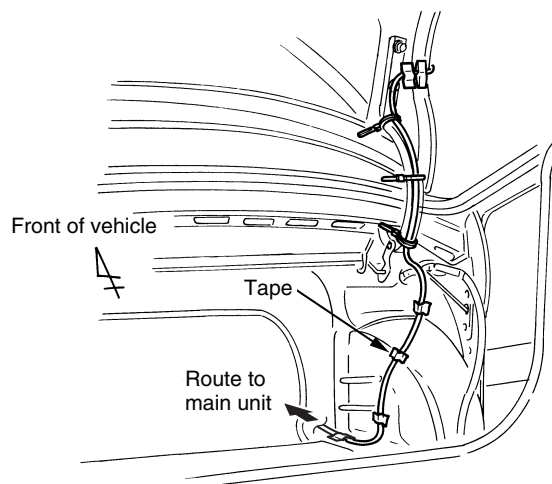

Installing the main unit

- Installation angle -



Tip

To maintain proper function, the main unit must be mounted less than 30 degrees. If the angle is in excess of 30 degrees, DVD/CD skipping and improper DVD/CD ejection may occur.

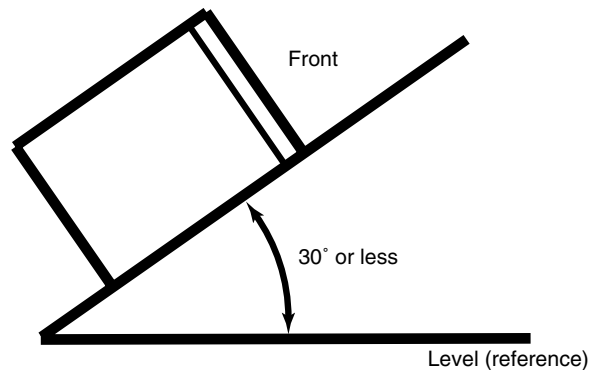

- Mounting the main unit -



Tip

- Carefully bind any excess length of wire that is connected to the main unit and secure it to an area of empty space in the vehicle so that it does not dislodge or interfere with the main unit or vehicle-side equipment. If the wires are not handled correctly, operating problems or short-circuits may occur, and this may result in the danger of fire or other accidents.
- Connect all wires before installing the main unit.

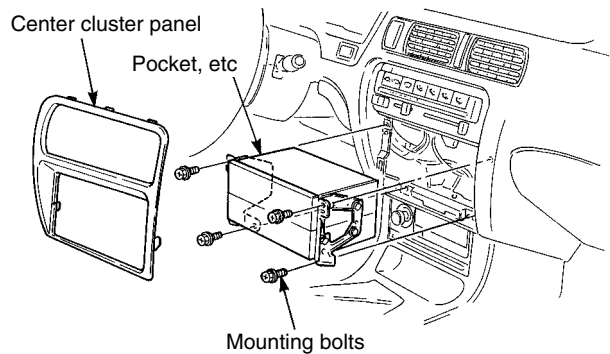

- 1 Remove the pocket and any other accessories from the center cluster to make room for the main unit.
- 2 Remove the mounting brackets for the pocket.
- 3 Attach the brackets to the main unit.



Tip

Be sure to use the supplied accessory mounting screws (Red: M5 x 8) as the mounting screws. If any other screws are used, they may damage the inside of the main unit.

- 4 Install the main unit in the vehicle.



Tip

Be careful not to forcefully push on the main unit's display or buttons during installation. This may result in damage to the main unit.

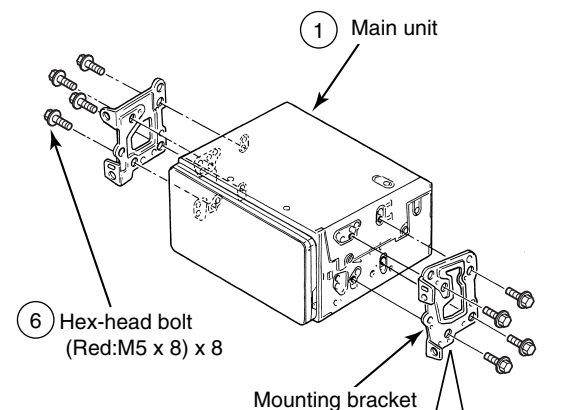

- 6 Hex-head bolt (Red:M5 x 8) x 8
 7 Flathead screw (Red:M5x8) x 8

Select the screws in accordance with the shapes of the screw holes in the mounting bracket.

Free Manuals Download Website

<http://myh66.com>

<http://usermanuals.us>

<http://www.somanuals.com>

<http://www.4manuals.cc>

<http://www.manual-lib.com>

<http://www.404manual.com>

<http://www.luxmanual.com>

<http://aubethermostatmanual.com>

Golf course search by state

<http://golfingnear.com>

Email search by domain

<http://emailbydomain.com>

Auto manuals search

<http://auto.somanuals.com>

TV manuals search

<http://tv.somanuals.com>