

Koldfront

PAC800S Portable Air Conditioner Owner's Manual

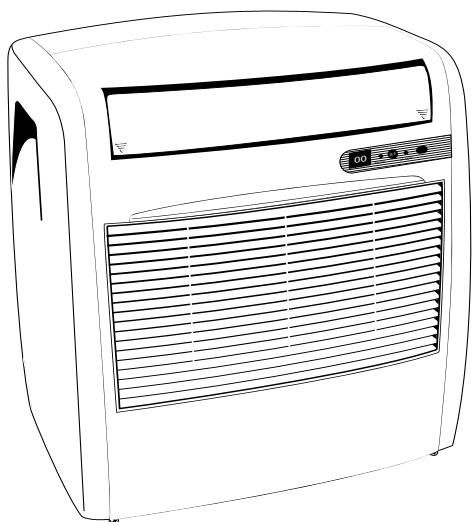

This owner's manual provides instructions on safe installation, use, and maintenance. Please read it carefully and save it for reference.



Welcome

Welcome and thank you for purchasing this Koldfront Portable Air Conditioner. We are glad you chose us. We take pride in knowing that, like our products, our customer service will be just as dependable. Once you complete our easy unit set up by following this manual, your portable air conditioner will provide you years of great service.

Please save the original product packaging in case you need to safely transport this portable air conditioner in the future.

For your reference:

Please write down the model and serial number here, as they are needed to obtain service for your unit, if necessary. The two numbers are on the label located on the back of your unit. You may also want to staple your receipt to this manual. This will provide you with a quick reference, as this information is needed for any service under your warranty.

Model Number: _____

Serial Number: _____

Date Purchased: _____

Need Assistance?

To better serve you, please do the following before contacting our customer service:

- Read this manual: it contains instructions to help you use and maintain your portable air conditioner properly.
- If you received a damaged appliance: please contact the dealer that sold you the appliance immediately.
- Read the section titled troubleshooting. This section will help you solve common problems that might occur. If you do require service, our friendly and efficient customer service representatives are available online via email at service@edgestar.com or by telephone at 1-866-319-5473.

Warning

Improper handling may cause serious damage to the unit. Read this manual carefully before operating the unit.

Do not wet the housing or control panel.



Do not cover the air outlet, while unit is in use.



Do not allow children to play with the controls or drop any objects into the air outlet.



Do not place objects or let any person sit on top of the unit.



Always turn the unit off and remove the power plug from the socket when cleaning.

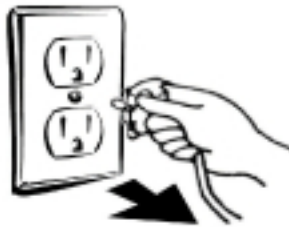

Do not attempt to remove any part of the casing unless by an authorized technician.



Remove the plug from the socket if the unit is not going to be used for a long period of time.

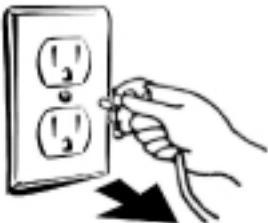

Use only the correct power supply-AC115V/60Hz.



Do not operate the unit with a damaged plug or loose outlet.



Make sure that the back of the unit is at least 4 inches or more away from a wall. Do not place the unit in front of curtains or drapes to ensure they do not obstruct the air intake. Route the power cord carefully to avoid a tripping hazard.

Warning

- If the power cord on this unit is damaged it must be replaced by the manufacturer, its service agent or a qualified person.
- This appliance is not intended for use by children.
- This appliance is intended for domestic use only.

Parts

Parts

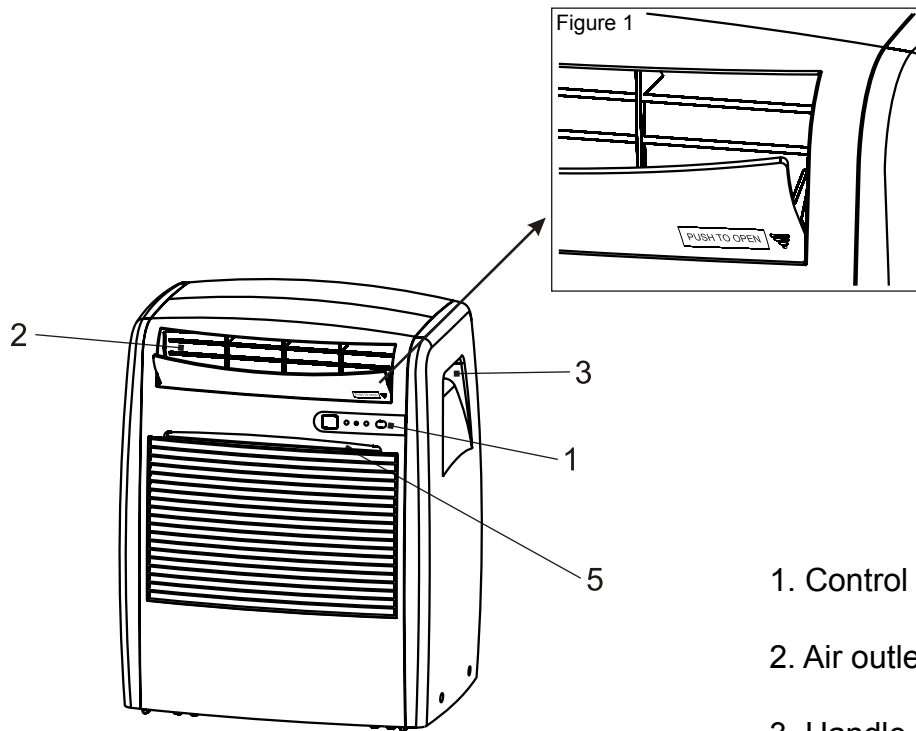

1. Control panel

2. Air outlet

3. Handle

4. Caster

5. Air filter

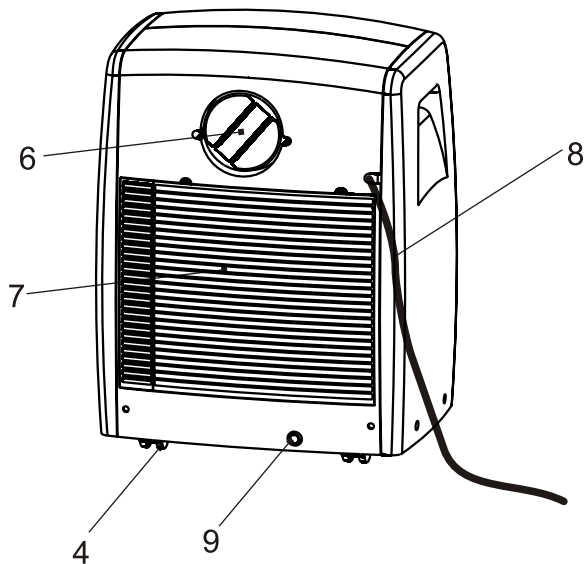

6. Air outlet (Exhaust)

7. Air intake (Condenser)

8. Power supply cord

9. Drain

Note: Please manually open the air outlet (Figure 1) to the desired position.

Operation

Remote Control

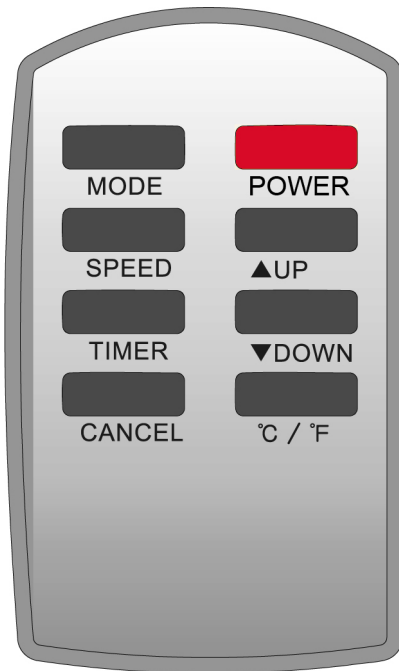

Note: All functions on this portable air conditioner are controlled by the remote. This remote accepts AAA batteries

Power control

The power button controls the power to the unit.

Modes

This unit has 3 settings:

- **Cooling** ● **Dehumidifying** ● **Fan**
- The settings are toggled by the mode button

Mode Light

The light on the display panel on the portable air conditioner changes color to indicate the mode (see next page for more information):

- Blue: When the light is blue, the unit is in cooling mode.
- Orange: When the light is orange, the unit is in dehumidifying mode.
- Green: When the light is green, the unit is in fan mode.

● **Cooling Mode (Blue light)**

In the cooling mode, room air is cooled and hot air is exhausted to the outside through the air exhaust hose. Adjust the fan speed and temperature to suit your desired comfort level.

Note: The air exhaust hose must be vented through a window when using the cooling mode (see the page titled Installation for more detail).

● **Dehumidifying Mode (Orange light)**

The dehumidifying mode removes water from the air without cooling the room. If the room temperature is below 77°F, the fan speed will be locked on "low;" above 77°F, the fan speed is adjustable.

Note: The exhaust hose is not required in dehumidifying mode. Note that the internal water tray will fill with water in this mode.

● **Fan Mode (Green light)**

Air is circulated throughout the room. The compressor does not turn on, so no air conditioning takes place.

Note: The unit does not need to be vented in fan mode.

Fan Speed

This unit has 3 fan speeds: High, Medium and Low. Press the speed button to toggle the speeds.

Note: Fan speeds will not be displayed on the control panel.

Temperature

To set the temperature in cooling mode, use the up "▲" and down "▼" buttons. The temperature setting range is from 61° F- 89° F.

Note: When in dehumidifying or fan mode, temperature setting is not required or allowed.

Fahrenheit/Celsius

Pressing this button will switch the temperature read-out between °C and °F.

Note: Initial setting is in °F

Setting the Timer

If the unit is on:

- Press the timer button.
- Use the up "▲" and down "▼" buttons to select a time (displayed in hours).
- After the selected time elapses, the unit will automatically shut off.

If the unit is off:

- Press the timer button.
- Use the up "▲" and down "▼" buttons to select a time (displayed in hours).
- Then select which mode you want the unit to automatically start in and make the necessary adjustments.
- After the selected time elapses, the unit will automatically turn on.

Note: The timer setting range is between 1 and 24 hours.

Cancelling the Timer

You may cancel the timer setting at any time by pressing the cancel button or by pressing the power button.

Operation

CONTROL PANEL

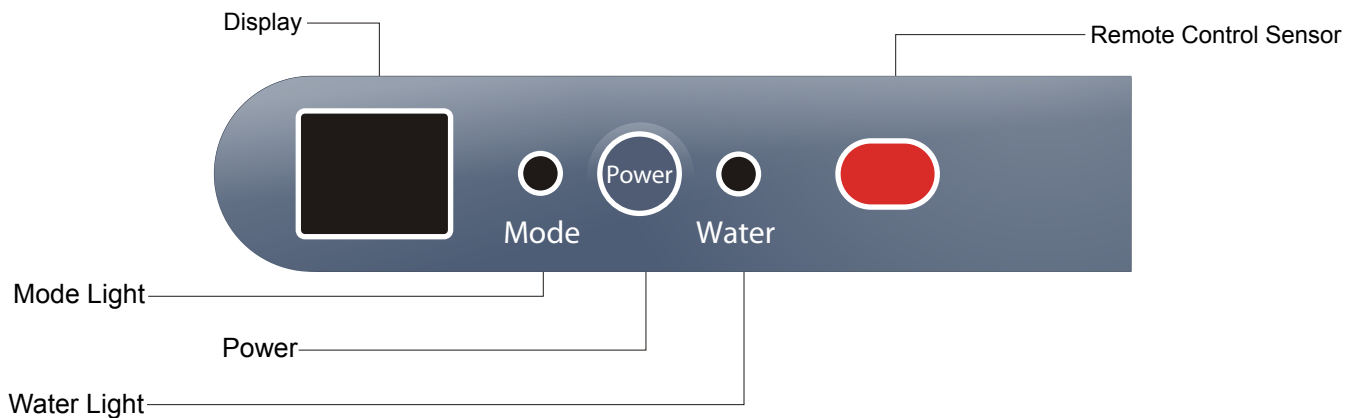

Power

- The power button turns the unit on and off.
- When you first press the power button, the unit will begin to operate in cooling mode. After you have used the unit, and turned it off, it will default to the last used mode/settings upon turning the unit on again. If power to the unit is interrupted while the unit is running, the air conditioner will restart itself in its last used mode/settings once power is restored.

Note: This "auto restart" function will restart the unit after power is restored. The compressor will resume after 3 minutes, if in use.

Water Light

This portable air conditioner is designed to exhaust most or all water condensed from the air (in cooling mode). In high humidity situations, the internal water reservoir may fill. The unit will automatically shut off and the water light will turn on. Once the water is manually drained, the unit will operate as normal.

Mode Light

The light on the display panel on the portable air conditioner changes color to indicate the mode.

- Blue: When the display panel is blue, the cooling mode is in use.
- Orange: When the display panel is orange, the dehumidifying mode is in use.
- Green: When the display panel is green, the fan mode is in use.

Display

The unit will display the ambient room temperature while in operation.

- Use the up "▲" and down "▼" buttons on the remote to change the set temperature (cooling mode only).
- In cooling mode, once you have set the temperature, the display will indicate your set temperature for 5 seconds then revert back to displaying the ambient temperature.
- After setting the timer, the indicator will blink 5 times before reverting back to displaying the ambient temperature.

Note: the displayed range of the ambient temperature is from 32°F to 122°F. Any temperature above 122°F will be displayed as "HI" on the indicator, and any temperature below 32°F will be displayed as "LO."

Note: After turning the air conditioner off, wait 3 minutes before turning it back on again.

Installation

Accessories

- 1. Plastic window kit.....2 pieces
- 2. Grated adapter.....1 piece
- 3. Screws.....4 pieces
- 4. Duct connector1 piece
- 5. Exhaust hose.....1 piece
- 6. Window kit connector.....1 piece
- 7. Vent cap.....1 piece

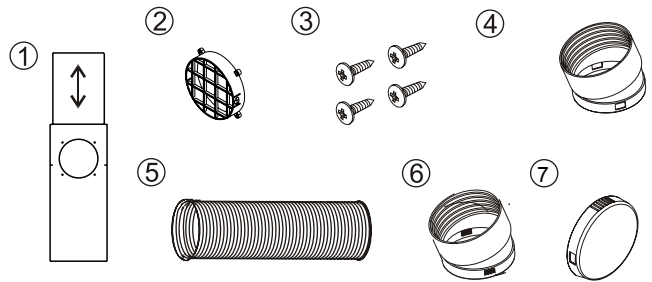

1. Loosen the screws on the plastic window kit(1) and adjust the sliding kit to the width or height of your window. Then tighten the screws to secure your adjustments to the window kit. (See below images for setup examples)
 2. Place the grated adapter(2) into the large hole on the flush side of the plastic window kit(1). Line up the 4 holes in the grated adaptor(2) with the pilot holes in the plastic window kit and fasten them together with a screw driver.
 3. Install the plastic window kit(1) into your window. If necessary, use duct tape to better secure the window kit.
 4. On the air conditioner, connect the duct connector(4) (the connector with the smaller slots) into the unit by aligning the tabs inside the unit with the slots and snapping them together. (See Fig. 1).
- Note: Once inserted, duct connectors cannot be removed.**
5. Attach the window kit connector(6) (the connector with the larger slots) onto the exhaust hose(5) by stretching the hose completely out and turning the window kit connector(6) clockwise, screwing it into the exhaust hose(5).
 6. Screw on the exhaust hose(5) to the duct connector(4) by turning it clockwise.
 7. Move the air conditioner towards the window. Align the slots on the window kit connector(6) to the tabs on the grated adapter(2) and snap them together. (See Fig. 2)
 8. To remove the window kit connector(6) from the grated adaptor(2), push in the tabs on the grated adaptor(2) and pull the window kit connector(6) away from the grated adaptor(2)
 9. To remove the window kit connector(6) and duct connector from the exhaust hose, twist the connections counterclockwise. To remove the grated adaptor(2) unscrew the 4 screws(3).
 10. The vent cap(7) may be installed on the grated adapter(2) (by aligning the slots with tabs and snapping them together) when the air conditioner is not in use. (See Fig. 3)

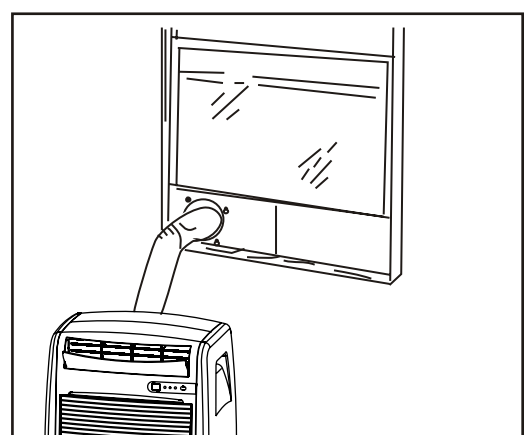
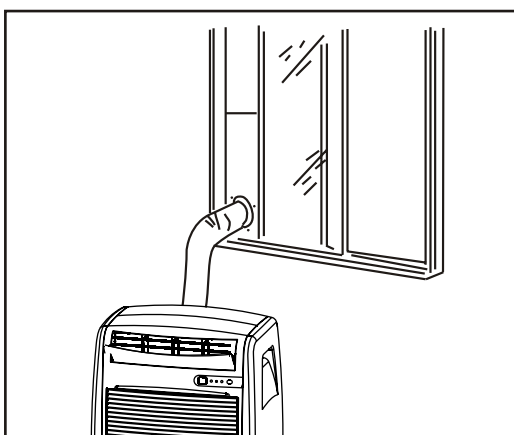
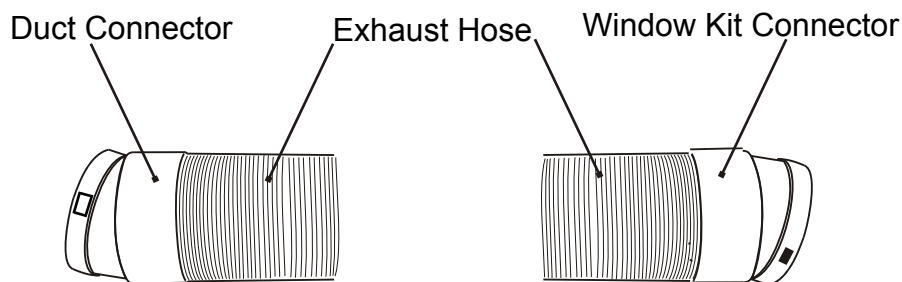
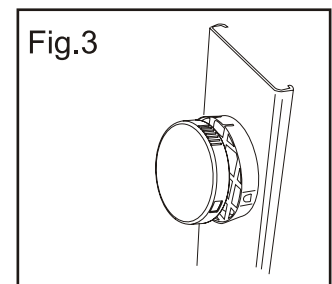
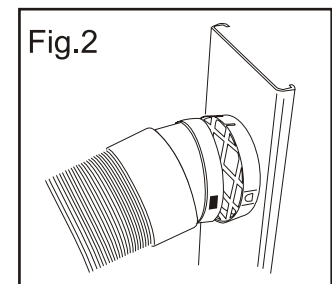
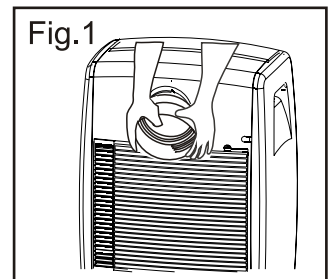

Maintenance

Appliance maintenance

1 Cut off the power supply

Turn off the appliance first before disconnecting from the power supply.

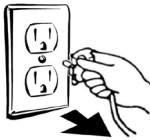

2 Wipe with a soft dry cloth.

Use lukewarm water (below 104°F) to clean the appliance.



3 Never use volatile substances such as gasoline or polishing powder to clean the appliance.



4 Never spray water onto the main unit.



Air filter maintenance

It is necessary to clean or replace the air filters periodically.

Clean as follows:

1 Stop the appliance and remove the activated carbon filter and the pre-filter.

The activated carbon filter attaches to the standard pre-filter. The activated carbon filter removes smoke, odors and other harmful particles, while the pre-filter removes dust.

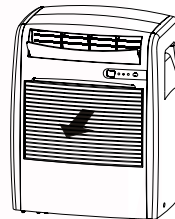

2 Clean and reinstall the pre-filter

Dirt can be cleaned off the pre-filter by cleaning it with a solution of soap in lukewarm water. After cleaning the pre-filter, allow it to air dry in shaded and cool place, then reinstall. Clean the pre-filter every two weeks if the air conditioner operates in a dusty environment.

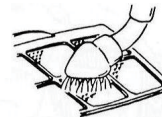

3 Replace the activated carbon filter

The activated carbon filter cannot be cleaned and needs to be disposed of when cleaning the pre-filter. EdgeStar sells replacement activated carbon filters. Contact customer service via email at service@edgestar.com or by telephone at 1-866-319-5473 to purchase additional activated carbon filters.

Maintenance and Storage

1. If you are not going to use this unit for a long time, be sure to drain the water from the reservoir by removing the drain cap and the rubber plug.
2. Before storing the unit, run it in fan mode for a few hours to dry any moisture on the coils to prevent mold.
3. Turn the unit off, clean the air filter and reinstall it.
4. Remove the exhaust hose and connectors and keep them in a safe place.

Optimizing Performance

For Maximum Performance and Efficiency:

1. Do not cover the air outlet (exhaust) while in use.
2. Do not place the unit in front of curtains or drapes- to ensure they do not obstruct the air intake.
3. Minimize the length of the exhaust hose.
4. Make sure the exhaust hose is as straight as possible.
5. Keep curtains, blinds or drapes closed during the sunniest part of the day.
6. Use the timer to operate the unit before it is needed. For example, set the timer to turn on the unit in cooling mode for 3 or more hours to cool the room before you arrive. You may want to operate the unit all day if you live in a warmer climate.
7. Minimize the heat sources (direct sunlight, computers, servers, people, etc.) in the room.
8. Close all windows and doors.
9. Use the unit in a contained room. For example, a room with four walls and a roof, instead of a partitioned studio, or warehouse.
10. Make sure the unit is on a level surface.
11. Minimize the amount of humidity in the room. For example, adding a dehumidifier.
12. To prolong the compressor's life, please wait at least 3 minutes before turning the unit back on after shutting it off.
13. Inspect and keep the pre-filters clean by cleaning regularly.
14. Inspect and replace the activated carbon filters regularly.
15. Perform routine maintenance.

Troubleshooting

Why is my air conditioner not functioning at all?

- The air conditioner may not be receiving electrical power. Press the test/reset buttons on the LCDI power cord.
- Move the air conditioner to another outlet, and test the outlet with a voltage tester or another appliance that is known to be non-defective. If the outlet is bad, contact an electrician and move the air conditioner to another outlet.
- If the remote will not work, first, check the batteries. The control panel may be unplugged from the circuit board. Contact customer service to repair.

Why is my air conditioner not cooling at all?

- The unit should be in a room where the ambient temperature is below 95°F . If the ambient temperature is above 95°F, the unit will likely not blow cold air but is not defective. Follow the below steps to increase the efficiency of your unit's compressor:
 - Minimize heat in the room.
 - Minimize the size of the area to be cooled (close doors and windows).
 - Close curtains or pull down blinds; minimize direct sunlight into the room.
 - Remove additional heat sources such as computer equipment (servers), etc.
 - Run the unit before it is needed (e.g., run the unit in the morning before the area gets hot, and continue to run the unit all day long in order to maintain a low temperature).
 - Use more than one unit or a larger unit to cool the area.
- Remove the exhaust hose and run the unit for 5 minutes. Stick your hand in front of the exhaust and then in front of the internal air louvers. Is the exhaust noticeably hotter than the interior air? If so, the unit is not defective; follow the above steps to maximize efficiency of your unit's compressor.
- If your unit has a filter, the filter may be dusty or otherwise blocked. Clean the filter or contact customer service to replace if necessary.
- Check to make sure the air intake or exhaust ports are not partially obstructed. If they are, remove the obstruction.

My unit turns on, but one of the fans is not turning or makes a loud noise? (Exhaust and evaporator fan)

- If the fan spins freely while the unit is off, but does not spin when the unit is on, then the probable cause is a loose wire from the fan motor to the circuit board, or a faulty fan motor. Contact customer service to replace faulty wiring or fan motor.
- If the fan does not spin freely, then the probable cause is a broken fan, or a foreign object has jammed the fan. Contact customer service if fan is broken, or unplug unit and attempt to remove foreign object.

Troubleshooting

Why are the control panel lights blinking randomly?

- Your air conditioner may have a minor electrical fault. Move the unit to another outlet or unplug the unit and plug it in again.
- Your air conditioner may be plugged into an outlet that cannot supply the correct voltage to the unit. Move the air conditioner to another outlet, and test the outlet with a voltage tester or another appliance that is known to be non-defective. If the outlet is bad, contact an electrician and move the air conditioner to another outlet.
- If that is not the problem, the unit may have a faulty control panel. Contact customer service.

My unit runs for a little while (generally about 90 seconds) and then suddenly trips its power cord (and/or the circuit breaker).

- Your air conditioner may need to be reset. Move the unit to another outlet or unplug the unit for 1 minute and plug it in again.
- Your air conditioner may be plugged into an outlet that cannot supply the correct voltage to the unit. Move the air conditioner to another outlet, and test the outlet with a voltage tester or another appliance that is known to be non-defective. If the outlet is bad, contact an electrician and move the air conditioner to another outlet.

My air conditioner is too loud?

- Your air conditioner may be positioned on a hard or uneven floor causing your unit to vibrate. Move the unit onto a level, carpeted surface.
- If the unit is level and a “knocking” noise is audible, the unit may have a faulty compressor. Contact customer service.

Why is my air conditioner leaking?

- Check for damage to the bottom of the unit. If damage is present, contact customer service.
- Make sure the unit on a level surface.
- Make sure you are running the unit with the drain plug installed. Make sure the drain cap as well as the rubber drain plug is attached to the unit.

Both fans are blowing, but only room temperature air is coming out of both fans?

- Make sure the unit is on “cooling” mode.
- Note that the compressor may take up to 3 minutes to turn on.
- Check to see if there is any oily residue on the bottom of the unit or inside the unit on the panels, or components. If this is the case, then the compressor has a cracked coil that is leaking oil and the unit must be replaced. Contact customer service to replace.

Specifications

- Figures noted in the contents are for reference only; consult the label on your air conditioner for precise information.

Description of product	Portable Air Conditioner
Model	PAC8000S
Voltage/Frequency	AC 115V/60Hz
Input Power	800W
Current	6.7A
Color	Silver
Dehumidifying capacity	71 Pints/Day
Coolant	R-22
Timer	24 hours
Dimensions (W) x (H) x (D)	19 1/4" x 24 3/4" x 13 1/4"
Weight	53 lbs.

Waste electrical products should not be disposed of with household waste. Please recycle where facilities exist. Check with your local authority for recycling advice.



Warranty

This EdgeStar product is warranted to be free from defective workmanship and materials for the first year following the date of original purchase. Replacement parts will be supplied free of charge for the first year following the date of original purchase. Labor will be performed free of charge for the first 90 days following the date of original purchase.

WHAT IS COVERED:

This warranty applies to the original purchaser only, and only covers defects in workmanship experienced during operation of the product under normal service, maintenance, and usage conditions. This warranty applies to the purchase and use of this product in residential settings within the United States of America.

WHAT IS NOT COVERED:

The following limitations apply to the coverage of this warranty:

Optional accessories, attachments, and appearance items are excluded from warranty coverage, as is shipping damage, and any damage caused by improper voltage or any other misuse, including abnormal service, handling, or usage.

This warranty does not cover normal wear and tear on parts or replacement of parts designed to be replaced, e.g. filters, etc.

This warranty does not cover service trips to deliver, pick-up, repair, or install the product, or to instruct in proper usage of the product.

Damages or operating problems resulting from abuse, operation outside environmental specifications, uses contrary to instructions provided in the owner's manual, accidents, vermin, fire, flood, improper installation, unauthorized service, unauthorized installation or modification, or commercial use are excluded from warranty coverage. This warranty does not cover labor incurred 91 days or more after the date of original purchase.

This warranty does not cover use of EdgeStar products in commercial settings.

DESCRIPTION OF WARRANTY SERVICE:

All defective product components covered by this warranty will be repaired or replaced, at EdgeStar's option, free of charge on a mail-in basis to EdgeStar's authorized repair facility during the first 90 days from the date of original purchase.

All defective product components covered by this warranty will be repaired or replaced, at EdgeStar's option, on a mail-in basis to EdgeStar's authorized repair facility during the time period beginning on the 91st day from the date of original purchase and ending one year from the date of original purchase. During this time period, parts will be supplied free of charge, but labor charges will apply.

All replacement parts and units will be new, re-manufactured, or refurbished.

All products and components replaced by EdgeStar under warranty service become the property of EdgeStar.

OBTAINING WARRANTY SERVICE:

Contact EdgeStar for troubleshooting assistance and warranty service authorization at 1-866-319-5473. Please have your order receipt available to confirm the date of purchase.

Once an EdgeStar authorized representative has confirmed that your product is eligible for warranty service, the product must be returned to our EdgeStar repair facility.

The purchaser is solely responsible for prepaying all shipping related costs to and from the repair facility.

EdgeStar is not responsible for damage resulting from shipper mishandling or improper packaging.

Do not return defective product to the place of purchase.

THIS WARRANTY IS IN LIEU OF ANY OTHER WARRANTY, EXPRESS OR IMPLIED, INCLUDING WITHOUT LIMITATION, ANY WARRANTY OF MERCHANTABILITY OR FITNESS FOR A PARTICULAR PURPOSE. TO THE EXTENT ANY IMPLIED WARRANTY IS REQUIRED BY LAW, IT IS LIMITED IN DURATION TO THE EXPRESS WARRANTY PERIOD ABOVE. NEITHER THE MANUFACTURER NOR ITS DISTRIBUTORS SHALL BE LIABLE FOR ANY INCIDENTAL, CONSEQUENTIAL, INDIRECT, SPECIAL, OR PUNITIVE DAMAGES OF ANY NATURE, INCLUDING WITHOUT LIMITATION, LOST REVENUES OR PROFITS, OR ANY OTHER DAMAGE WHETHER BASED IN CONTRACT, TORT, OR OTHERWISE. SOME STATES DO NOT ALLOW THE EXCLUSION OF INCIDENTAL OR CONSEQUENTIAL DAMAGES, SO THE ABOVE EXCLUSION MAY NOT APPLY TO YOU. THIS WARRANTY GIVES YOU SPECIFIC LEGAL RIGHTS. YOU MAY HAVE OTHER RIGHTS THAT VARY FROM STATE TO STATE.

Koldfront

For more information on EdgeStar and to view our
full line of products, please visit our website:
<http://www.edgestar.com>

EdgeStar Products
Box 81336
Austin, Texas 78708-1336
Toll Free : 1-866-319-5473

Free Manuals Download Website

<http://myh66.com>

<http://usermanuals.us>

<http://www.somanuals.com>

<http://www.4manuals.cc>

<http://www.manual-lib.com>

<http://www.404manual.com>

<http://www.luxmanual.com>

<http://aubethermostatmanual.com>

Golf course search by state

<http://golfingnear.com>

Email search by domain

<http://emailbydomain.com>

Auto manuals search

<http://auto.somanuals.com>

TV manuals search

<http://tv.somanuals.com>