

EIKI

**USB Recorder
CD Player
Cassette Tape Recorder**

8080

Owner's Manual

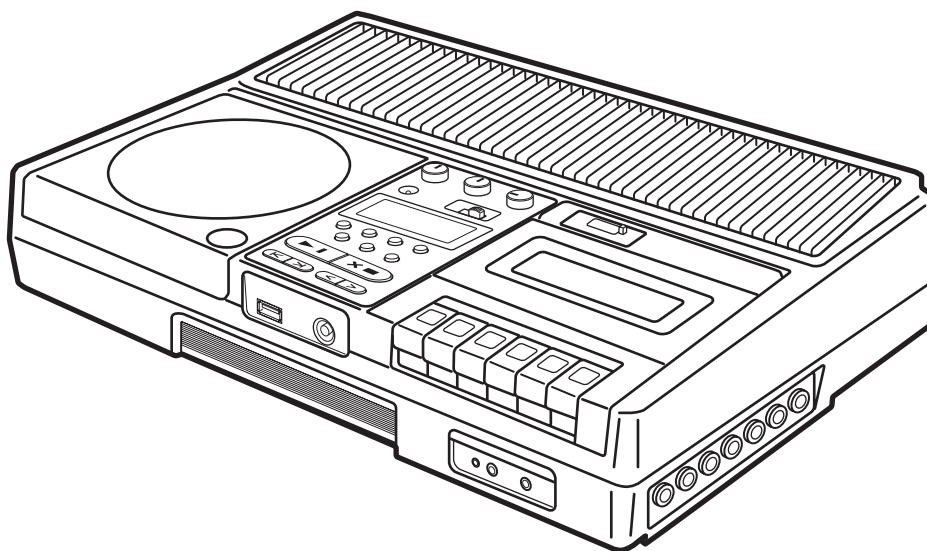

Thank you very much for purchasing an EIKI 8080. Please read this manual thoroughly for information on how to use the 8080 properly, and keep the manual along with the warranty card in a safe place for future reference.

WARNING:

TO REDUCE THE RISK OF FIRE OR ELECTRIC SHOCK, DO NOT EXPOSE THIS APPARATUS TO RAIN OR MOISTURE.

CAUTION:

TO REDUCE THE RISK OF ELECTRIC SHOCK, DO NOT REMOVE COVER (OR BACK). NO USER-SERVICEABLE PARTS INSIDE. REFER SERVICING TO QUALIFIED SERVICE PERSONNEL.



WARNING
RISK OF ELECTRIC SHOCK
DO NOT OPEN

AVIS
RISQUE DE CHOC ELECTRIQUE
NE PAS OUVRIR



The lightning flash with arrowhead symbol, within an equilateral triangle, is intended to alert the user to the presence of uninsulated "dangerous voltage" within the product's enclosure that may be of sufficient magnitude to constitute a risk of electric shock to persons.



The exclamation point within an equilateral triangle is intended to alert the user to the presence of important operating and maintenance (servicing) instructions in the literature accompanying the appliance.

Important Safety Instructions

1. Read these instructions.
2. Keep these instructions.
3. Heed all warnings.
4. Follow all instructions.
5. Do not use this apparatus near water.
6. Clean only with dry cloth.
7. Do not block any ventilation openings. Install in accordance with the manufacturer's instructions.
8. Do not install near any heat sources such as radiators, heat registers, stoves, or other apparatus (including amplifiers) that produce heat.
9. Do not defeat the safety purpose of the polarized or grounding-type plug. A polarized plug has two blades with one wider than the other. A grounding type plug has two blades and a third grounding prong. The wide blade or the third prong are provided for your safety. If the provided plug does not fit into your outlet, consult an electrician for replacement of the obsolete outlet.
10. Protect the power cord from being walked on or pinched particularly at plugs, convenience receptacles, and the point where they exit from the apparatus.
11. Only use attachments/accessories specified by the manufacturer.
12. Use only with the cart, stand, tripod, bracket, or table specified by the manufacturer, or sold with the apparatus. When a cart is used, use caution when moving the cart/apparatus combination to avoid injury from tip-over. PORTABLE CART WARNING
13. Unplug this apparatus during lightning storms or when unused for long periods of time. S3125A
14. Refer all servicing to qualified service personnel. Servicing is required when the apparatus has been damaged in any way, such as power-supply cord or plug is damaged, liquid has been spilled or objects have fallen into the apparatus, the apparatus has been exposed to rain or moisture, does not operate normally, or has been dropped.



15. Damage Requiring Service

Unplug the apparatus from the wall outlet and refer servicing to qualified service personnel under the following conditions:

- A. When the power-supply cord or plug is damaged,
- B. If liquid has been spilled, or objects have fallen into the apparatus,
- C. If the apparatus has been exposed to rain or water,
- D. If the apparatus does not operate normally by following the operating instructions. Adjust only those controls that are covered by the operating instructions as an improper adjustment of other controls may result in damage and will often require extensive work by a qualified technician to restore the apparatus to its normal operation,
- E. If the apparatus has been dropped or damaged in any way, and
- F. When the apparatus exhibits a distinct change in performance this indicates a need for service.

16. Object and Liquid Entry

Never push objects of any kind into the apparatus through openings as they may touch dangerous voltage points or short-out parts that could result in a fire or electric shock. The apparatus shall not be exposed to dripping or splashing and no objects filled with liquids, such as vases shall be placed on the apparatus. Don't put candles or other burning objects on top of this unit.

17. If you install the apparatus in a built-in installation, such as a bookcase or rack, ensure that there is adequate ventilation.

Leave 20 cm (8") of free space at the top and sides and 10 cm (4") at the rear. The rear edge of the shelf or board above the apparatus shall be set 10 cm (4") away from the rear panel or wall, creating a flue-like gap for warm air to escape.

Precautions

- 1. Recording Copyright**—Unless it's for personal use only, recording copyrighted material is illegal without the permission of the copyright holder.
- 2. AC Fuse**—The AC fuse inside the unit is not user-serviceable. If you cannot turn on the unit, contact your dealer.
- 3. Care**—Occasionally you should dust the unit all over with a soft cloth. For stubborn stains, use a soft cloth dampened with a weak solution of mild detergent and water. Dry the unit immediately afterwards with a clean cloth. Don't use abrasive cloths, thinners, alcohol, or other chemical solvents, because they may damage the finish or remove the panel lettering.
- 4. Power**
WARNING
BEFORE PLUGGING IN THE UNIT FOR THE FIRST TIME, READ THE FOLLOWING SECTION CAREFULLY.
AC outlet voltages vary from country to country. Make sure that the voltage in your area meets the voltage requirements printed on the unit's rear panel (e.g., AC 230 V, 50 Hz or AC 120 V, 60 Hz).
The power cord plug is used to disconnect this unit from the AC power source. Make sure that the plug is readily operable (easily accessible) at all times.
Plug Cord into a properly ground wall outlet. The three-prong plug should be used without a two-prong adapter whenever possible.
- 5. Preventing Hearing Loss**
Caution
Excessive sound pressure from earphones and headphones can cause hearing loss.
- 6. Never Touch this Unit with Wet Hands**—Never handle this unit or its power cord while your hands are wet or damp. If water or any other liquid gets inside this unit, have it checked by your dealer.
- 7. Handling Notes**
 - If you need to transport this unit, use the original packaging to pack it how it was when you originally bought it.
 - Do not leave rubber or plastic items on this unit for a long time, because they may leave marks on the case.
 - This unit's top and rear panels may get warm after prolonged use. This is normal.
 - If you do not use this unit for a long time, it may not work properly the next time you turn it on, so be sure to use it occasionally.
 - When you've finished using this unit, remove CD, cassette tape, USB flash drive and turn off the power.
- 8. Installing this Unit**
 - Install this unit in a well-ventilated location.
 - Ensure that there's adequate ventilation all around this unit, especially if it's installed in an audio rack. If the ventilation is inadequate, the unit may overheat, leading to malfunction.
 - Do not expose this unit to direct sunlight or heat sources, because its internal temperature may rise, shortening the life of the optical pickup.
 - Avoid damp and dusty places, and places subject to vibrations from loudspeakers. Never put the unit on top of, or directly above a loudspeaker.
 - Install this unit horizontally. Never use it on its side or on a sloping surface, because it may cause a malfunction.

9. Moisture Condensation

Moisture condensation may damage this unit.

Read the following carefully:

Moisture may condense on the lens of the optical pickup, one of the most important parts inside this unit.

- Moisture condensation can occur in the following situations:
 - The unit is moved from a cold place to a warm place.
 - A heater is turned on, or cold air from an air conditioner is hitting the unit.
 - In the summer, when this unit is moved from an air conditioned room to a hot and humid place.
 - The unit is used in a humid place.
- Do not use this unit when there's the possibility of moisture condensation occurring. Doing so may damage your discs and certain parts inside this unit.

If condensation does occur, remove CD, cassette tape, USB flash drive and leave this unit turned on for two to three hours. By this time, the unit will have warmed up and any condensation will have evaporated.

10. Rated label

Rated label and caution marking are located on the bottom of this unit.

For U.S. models

FCC Information for User

CAUTION:

The user changes or modifications not expressly approved by the party responsible for compliance could void the user's authority to operate the equipment.

NOTE:

This equipment has been tested and found to comply with the limits for a Class B digital device, pursuant to Part 15 of the FCC Rules. These limits are designed to provide reasonable protection against harmful interference in a residential installation.

This equipment generates, uses and can radiate radio frequency energy and, if not installed and used in accordance with the instructions, may cause harmful interference to radio communications. However, there is no guarantee that interference will not occur in a particular installation. If this equipment does cause harmful interference to radio or television reception, which can be determined by turning the equipment off and on, the user is encouraged to try to correct the interference by one or more of the following measures:

- Reorient or relocate the receiving antenna.
- Increase the separation between the equipment and receiver.
- Connect the equipment into an outlet on a circuit different from that to which the receiver is connected.
- Consult the dealer or an experienced radio/TV technician for help.

For Canadian Models

NOTE: THIS CLASS B DIGITAL APPARATUS COMPLIES WITH CANADIAN ICES-003.

For models having a power cord with a polarized plug:

CAUTION: TO PREVENT ELECTRIC SHOCK, MATCH WIDE BLADE OF PLUG TO WIDE SLOT, FULLY INSERT.

Modèle pour les Canadien

REMARQUE: CET APPAREIL NUMÉRIQUE DE LA CLASSE B EST CONFORME À LA NORME NMB-003 DU CANADA.

Sur les modèles dont la fiche est polarisée:

ATTENTION: POUR ÉVITER LES CHOCS ÉLECTRIQUES, INTRODUIRE LA LAME LA PLUS LARGE DE LA FICHE DANS LA BORNE CORRESPONDANTE DE LA PRISE ET POUSSER JUSQU'AU FOND.

For British models

Replacement and mounting of an AC plug on the power supply cord of this unit should be performed only by qualified service personnel.

IMPORTANT

The wires in the mains lead are coloured in accordance with the following code:

Blue: Neutral
Brown: Live

As the colours of the wires in the mains lead of this apparatus may not correspond with the coloured markings identifying the terminals in your plug, proceed as follows:

The wire which is coloured blue must be connected to the terminal which is marked with the letter N or coloured black.

The wire which is coloured brown must be connected to the terminal which is marked with the letter L or coloured red.

IMPORTANT

The plug is fitted with an appropriate fuse. If the fuse needs to be replaced, the replacement fuse must be approved by ASTA or BSI to BS1362 and have the same ampere rating as that indicated on the plug. Check for the ASTA mark or the BSI mark on the body of the fuse.

If the power cord's plug is not suitable for your socket outlets, cut it off and fit a suitable plug. Fit a suitable fuse in the plug.

CLASS 1 LASER PRODUCT

Product complies with DHHS rules 21 CFR subchapter J part 1040: 10 at date of manufacture.

DANGER – invisible laser radiation when open and interlock failed or defeated. Avoid direct exposure to the beam.

CAUTION – use of all controls, adjustments or performance of procedures other than those specified herein may result in hazardous radiation exposure.



The CE Mark is a Directive conformity mark of the European Community (EC).

Supplied Accessory

Owner's manual (this book)

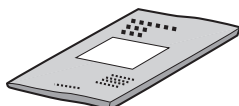

Contents

Precautions	3
Supplied Accessory	4
Features	6
Orientation	7
Controls and Connections.....	7
Top panel	7
Display	8
Front panel	8
Right side panel	8
Basic Operation	9
Turning the Power On.....	9
Turning the Power Off	9
Basic Operation and Connection.....	10
Adjusting the tone	10
Adjusting the left and right level balance	10
Adjusting the volume.....	10
Selecting the input.....	10
Connecting a microphone.....	11
Connecting an external device	11
Listening through the headphones	11
Connecting external speakers	11
Listening to Tracks on a CD or USB Flash Drive.....	12
Changing the display indication	12
Disconnecting the USB flash drive.....	12
Stopping playback	12
Pausing playback.....	12
Skipping tracks (Locating the beginning of a track)..	13
Fast forward/fast rewind (Searching).....	13
Selecting a folder	13
Advanced Playback from a CD or USB Flash Drive.....	14
Playback Pitch Control.....	14
Repeat Playback	14
Random Playback.....	14
Program Playback	14
Listening to a Tape	16
Stopping the tape playback.....	16
Pausing the tape playback	16
Rewinding or fast forwarding the tape.....	16

Recording to a USB Flash Drive	17
Recording from a CD to a USB Flash Drive.....	17
2X Recording from a CD to a USB Flash Drive	18
Recording from a Cassette Tape to a USB Flash Drive.....	19
Recording to a Cassette Tape	20
Recording from a CD to a Cassette Tape.....	20
Recording from a USB Flash Drive to a Cassette Tape	21
Using a Microphone or External Device	22
Mic Mixing Recording	22
Mic Mixing Playback (Microphone Amplification)	22
Using an External Device	23
Supported Discs, USB Devices, and Files ..	24
Supported Discs.....	24
Supported USB Devices	24
Supported Files on a CD and USB Flash Drive.....	24
About Folders and Files.....	25
File Playback Sequence	25
Folders and Files Created during Recording	25
About CD and Cassette Tape	26
Handling CDs.....	26
Handling Cassette Tapes	27
Appendix	28
Maintenance.....	28
Troubleshooting	29
Specifications.....	31

Features

CD player compatible with MP3 and WMA files

- The 8080's built-in CD player can play not only music CDs but MP3 and WMA files.
- It is also compatible with CD-R and CD-RW discs.

USB recorder

- The built-in USB recorder can play MP3 and WMA files on the connected USB flash drive.
- It also converts audio data on a CD or cassette tape into the MP3 format and records it to the connected USB flash drive.

Cassette tape recorder

- The 8080's built-in cassette recorder not only plays audio on a tape, but records tracks from the CD or the connected USB flash drive to a cassette tape.

Playback pitch (speed) control

- You can change the playback pitch (speed) of tracks on the CD or USB flash drive in the range of -50% to +100% without transposing the tune.

Repeat, Program and Random Playback functions

- Repeat, Program and Random Playback functions are available during playback of tracks on a CD or USB flash drive.

7W+7W high-output amplifier

- The internal high-output amplifier can drive not only the built-in stereo speakers, but external speakers (optional) as well.

Five headphone jacks

- Up to five headphone jacks can be used simultaneously.

Microphone and AUX input connectors

- These connectors can be used for mic mixing or mic sound amplification.
- Playback, pause and resume recording can be controlled via the remote switch on a connected microphone (optional).
- The AUX input (monaural) enables you to connect the device to an external device.

Robust design scheme

- A very robust product design facilitates years of reliable use in even demanding environments.

Controls and Connections

Please refer to the bracketed page number for a detailed explanation of the corresponding control.

Top panel

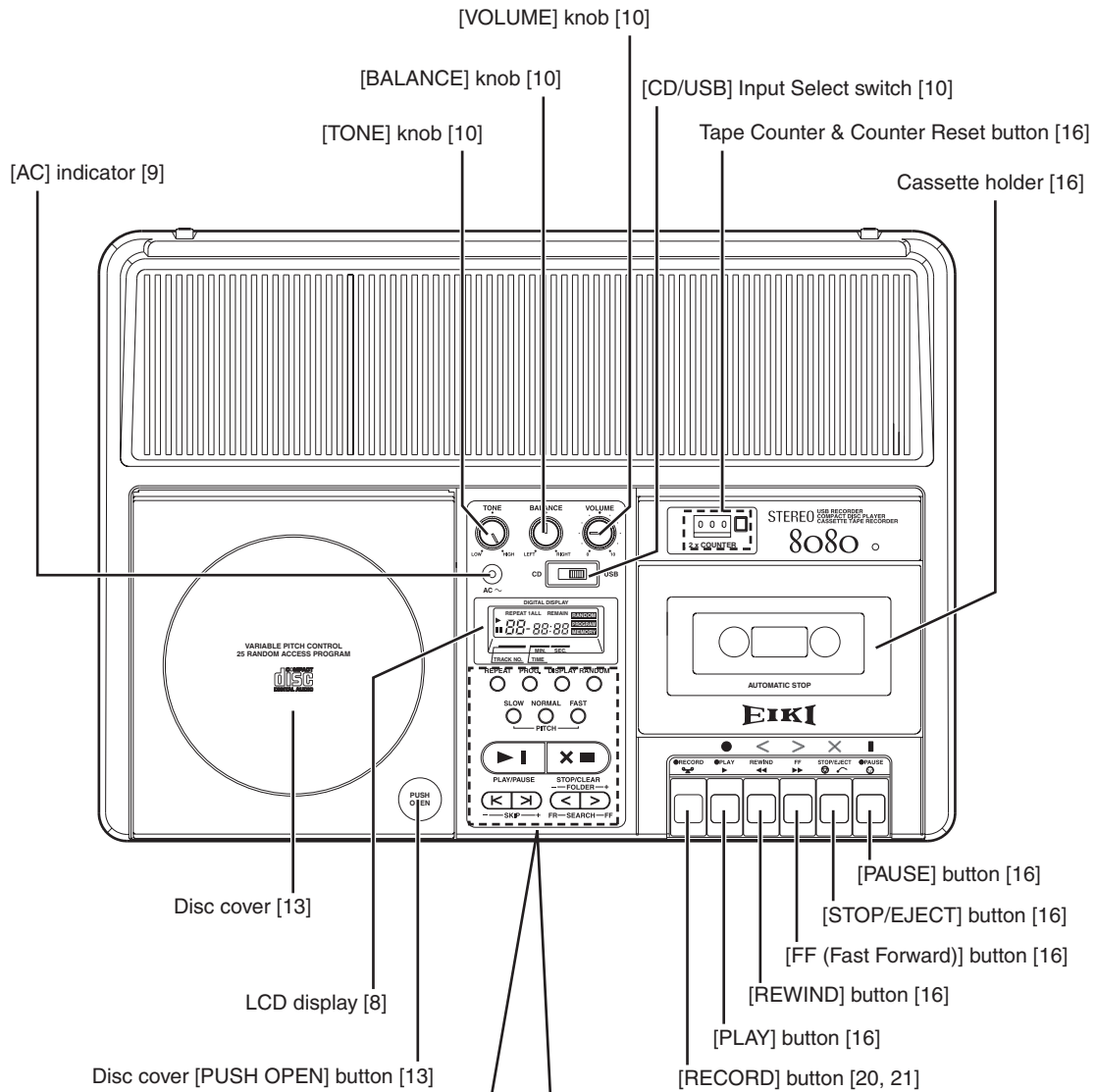

CD/USB transport section

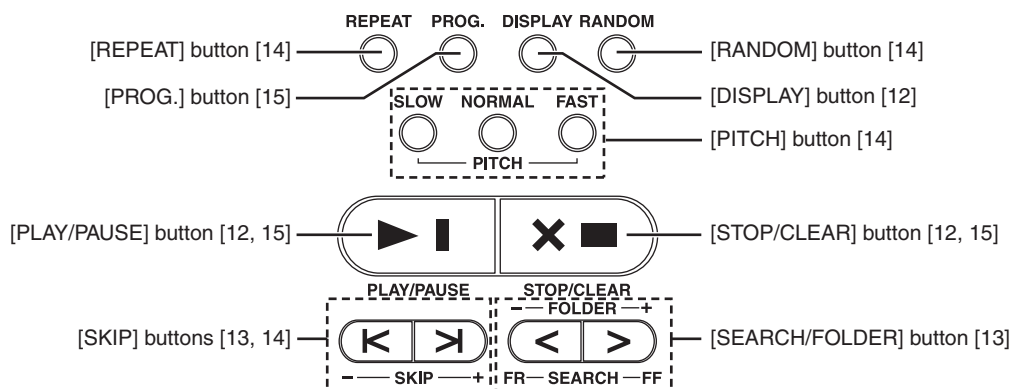

Display

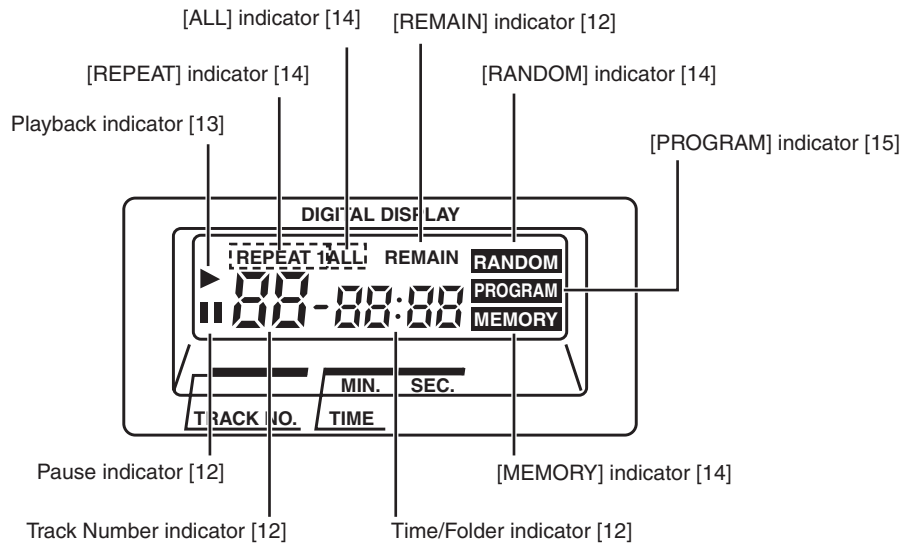

Front panel

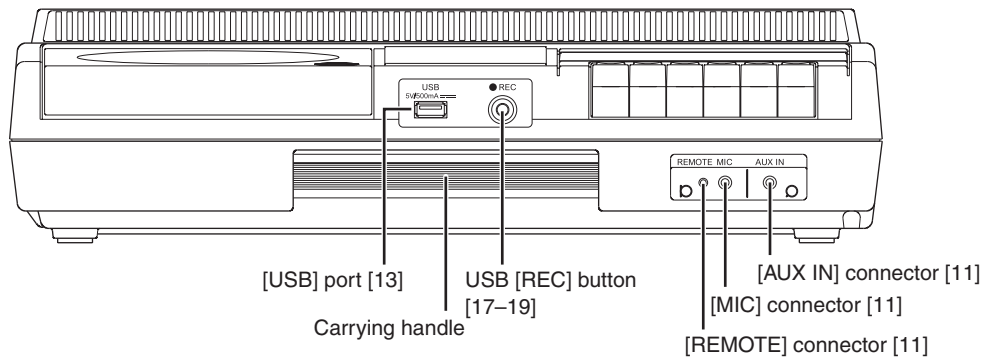

Right side panel

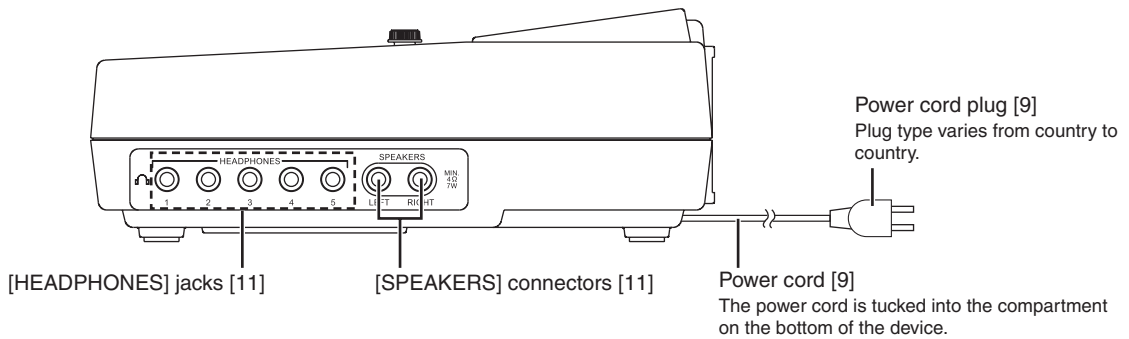

Turning the Power On

Connect the power cord of the 8080 to an AC outlet of appropriate voltage.

The [AC] indicator lights up.

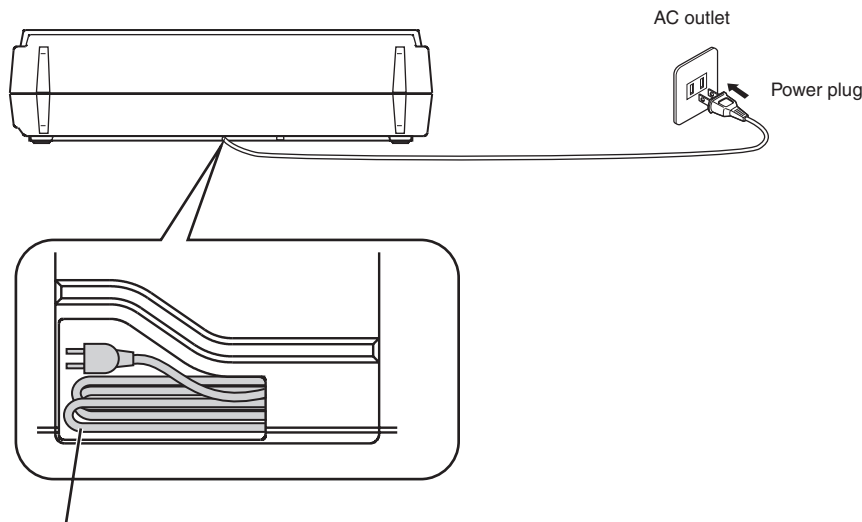

The power cord is tucked inside the compartment on the bottom of the unit. Before you use the unit, extract the power cord from the compartment. If you plan not to use the unit for a long period of time, or if you plan to carry or transport the unit, store the power cord in the compartment.

CAUTION:

- The 8080 does not have a power switch. When you connect the power cord to the AC outlet, the power to the unit is turned on.

Turning the Power Off

Stop the CD and cassette tape, and remove the USB flash drive.
Then remove the power cord plug from the AC outlet.

The [AC] indicator turns off.

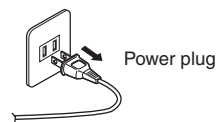

CAUTION:

- The 8080 does not have a power switch. Remove the power cord plug from the AC outlet when you are not using the unit.
- If a USB flash drive has been connected to the [USB] port, first remove the USB flash drive by following the correct procedure (see page 12), then remove the power cord plug from the AC outlet.

Basic Operation and Connection

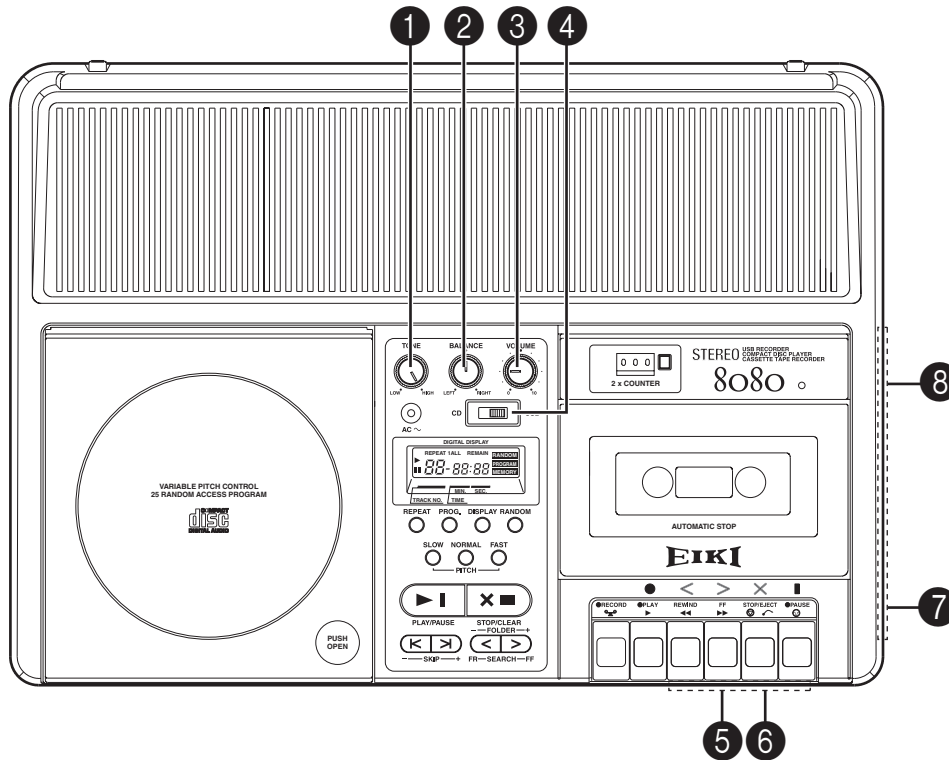

1 Adjusting the tone

TONE



In most cases, set the [TONE] knob to “HIGH,” which is the standard setting. If you want to cut some high frequency range or reduce hiss, rotate the knob counter-clockwise.

* “Hiss” is high frequency noise that is often present on analogue magnetic tape recordings.

2 Adjusting the left and right level balance

BALANCE



In most cases, set the [BALANCE] knob to the center. Turning the knob counter-clockwise pans the sound to the left in the stereo image, and turning it clockwise pans the sound to the right.

3 Adjusting the volume

VOLUME

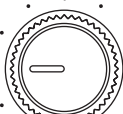

Rotate the [VOLUME] knob clockwise to raise the volume, or counter-clockwise to lower the volume.

CAUTION:

- If the volume level is too high, the sound may be distorted or the speakers may be damaged. Adjust the volume carefully.

4 Selecting the input

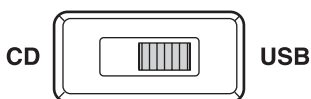

To listen to a CD, set the [CD/USB] Input Select switch to “CD.” To listen to an audio file on the USB flash drive, set the [CD/USB] Input Select switch to “USB.”

The corresponding (CD or USB) transport controls (see page 13) become active. To record audio from a cassette tape to a connected USB flash drive, set this switch to “USB.”

CAUTION:

- The cassette tape transport controls have the highest priority. consequently, during playback of a cassette tape, you cannot play a CD or an audio file on the connected USB flash drive.

5 Connecting a microphone

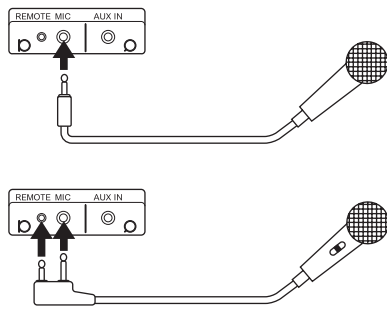

Connect a monaural dynamic microphone to the [MIC] connector on the front panel. The connector accepts a monaural mini plug (ø3.5mm). If you are connecting a microphone with a built-in remote switch, connect it to the [MIC] and [REMOTE] connectors.

CAUTION:

- The [MIC] connector is not compatible with a condenser-type microphone. Be sure to use a dynamic microphone.

7 Listening through the headphones

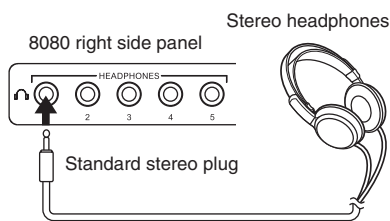

Connect the standard stereo plug (ø6.3mm) of the headphones to one of the [HEADPHONES] connectors on right side. If your headphones use a stereo mini plug (ø3.5mm), use a commercially available adapter plug. When you connect headphones, the internal speaker output will be muted.

CAUTION:

- You can connect up to five sets of headphones to the 8080 simultaneously. If you are using multiple headphones, use the same type so that the volume level will be consistent among all headphones.

6 Connecting an external device

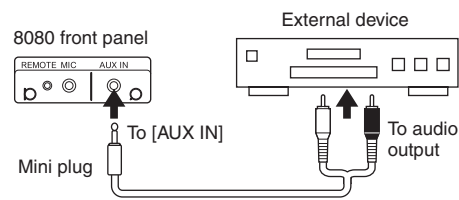

Connect the audio output of an external device to the [AUX IN] connector on the front panel of the 8080. The [AUX IN] connector accepts monaural signals via a monaural mini plug (ø3.5mm). Use an appropriate commercially available cable.

CAUTION:

- You cannot use the [AUX IN] connector and the [MIC] connector simultaneously. If you are using the [AUX IN] connector, remove the microphone from the [MIC] connector.

8 Connecting external speakers

Although the 8080 features a built-in speaker, you can also connect external speakers if desired.

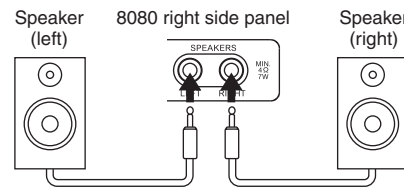

Use the SPEAKERS [LEFT]/[RIGHT] connectors (which accept monaural ø6.3mm standard plugs) on the right side. When you connect external speakers, the built-in speaker output will be muted.

CAUTION:

- Be sure to use speakers with an impedance of 4Ω or higher.

Listening to Tracks on a CD or USB Flash Drive

NOTE:

When you change the [CD/USB] Input Select switch setting during playback of a CD or USB flash drive, playback will stop.

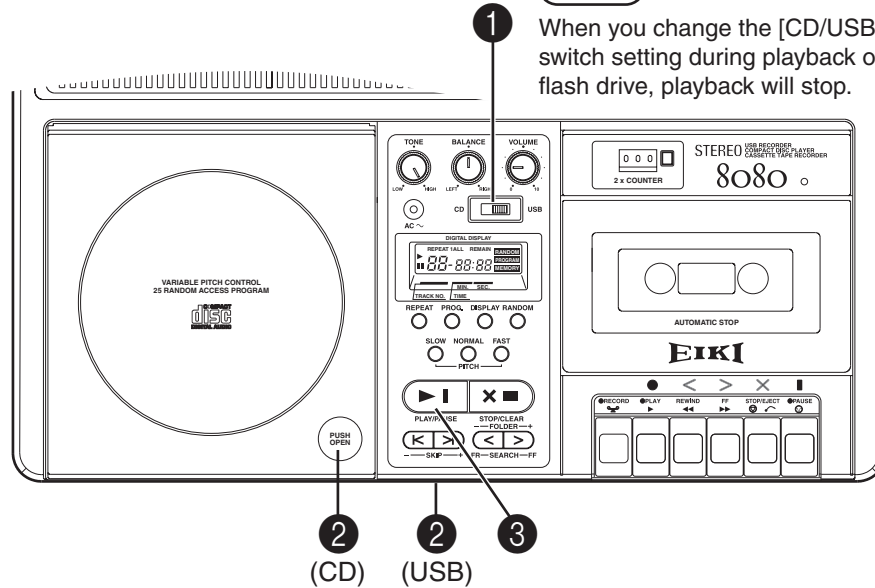

CAUTION:

Opening the disc cover during playback or while the CD is paused may cause the spinning disc to fly out, resulting in personal injury or damage to the disc. Be sure to press the [STOP/CLEAR] button to cancel playback or pause, wait for more than five seconds, then open the disc cover. If the CD is still spinning when you open the cover, be careful not to touch the disc.

Changing the display indication

Pressing the [DISPLAY] button repeatedly cycles through the following indicators on the display.

While playback is stopped:

Music CD



Total number of tracks Total playback time

MP3/WMA (CD/USB)

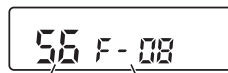

Total number of files * Total number of folders

* If the total number of files exceeds 99, "--" will be displayed.

* If the stop position is memorized, the position will be displayed.

During playback or pause

Music CD

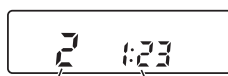

Track number Elapsed track playback time

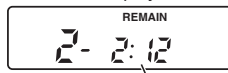

Remaining track playback time

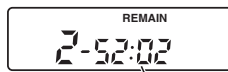

Total remaining playback time on the disc

MP3/WMA (CD/USB)



Track number Elapsed track playback time*

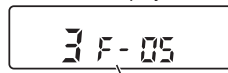

Folder number

* The time indicator may not display the correct value for some MP3/WMA files in the following cases:
 - When you play back a VBR (Variable Bit Rate) file.
 - When you fast rewind or fast forward a file.
 - When you change the pitch (playback speed).

Disconnecting the USB flash drive

Set the [CD/USB] Input Select switch to "USB," then press the [STOP/CLEAR] button repeatedly until the unit displays the following indication.



After the dotted line indicator "-- --" stops flashing and lights up steadily, make sure that the USB flash drive's indicator is turned off. Then remove the USB flash drive.

CAUTION:

- When the dotted line indicator "-- --" lights up, you cannot play or record audio using the USB flash drive. If you wish to do so, disconnect the USB flash drive, then connect it again.

Stopping playback

Press the [STOP/CLEAR] button.

To cancel the Resume function, press the button again.

Pausing playback

Press the [PLAY/PAUSE] button.

The **||** indicator lights up.



Press the button again to resume playback.

Resume function

While the CD player is playing a CD, if you press the [STOP/CLEAR] button, change the Input Select switch setting, or play back a cassette tape, the CD player will stop playing and memorize the stopped position. The next time you play the CD, playback will start from the stopped position. This is called Resume function.

Instead, if you want to play back the CD from the first track, press the [STOP/CLEAR] button again to cancel the Resume function, then press the [PLAY/PAUSE] button.

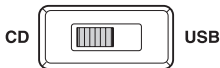
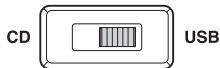
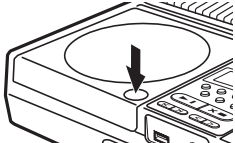
The Resume function will also be cancelled when you open the disc cover, remove the USB flash drive, or turn off the power to the unit.

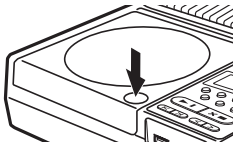
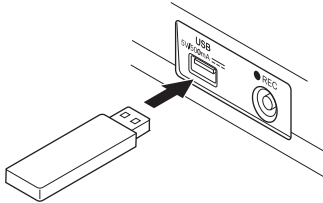
	CD	USB flash drive
1	<p>Set the Input Select switch to "CD."</p> 	<p>Set the Input Select switch to "USB."</p> 
2	<p>Insert a CD.</p> <p>1 Open the disc cover.</p>  <p>2 Place a CD on the turntable with its label side facing up.</p>  <p>3 Close the disc cover.</p>  <p>CAUTION:</p> <ul style="list-style-type: none"> Press the [PUSH OPEN] button to open or close the disc cover. Follow the same steps for playing an 8cm CD. Do not use an adapter. Otherwise, the CD player or the CD may be damaged. 	<p>Connect the USB flash drive.</p> <p>Connect the USB flash drive to the [USB] port on the front panel.</p>  <p>CAUTION:</p> <ul style="list-style-type: none"> The [USB] port does not support a USB hub. Connect the USB flash drive directly to the [USB] port. The [USB] port does not support connection with a computer. To disconnect the USB flash drive, be sure to follow the instructions in the section "Disconnecting the USB flash drive" on page 12.
3	<p>Press the [PLAY/PAUSE] button.</p> <p>The ► indicator lights up and playback starts. Adjust the volume as desired.</p>	<p>CAUTION:</p> <ul style="list-style-type: none"> You cannot play a CD or USB flash drive during cassette tape playback.

Skipping tracks (Locating the beginning of a track)

Use the [SKIP] (◀/▶) buttons to select the desired track number.

Pressing the [◀] button once will locate the top of the current track. To go back to the previous tracks, press the [◀] button repeatedly.

Fast forward/fast rewind (Searching)

During playback or pause, press and hold the [SEARCH <] or [SEARCH >] button, then release the button at the desired position.

You can fast forward or rewind an MP3 or WMA file only while the unit displays the time indicators. When the beginning of a track is reached after fast rewind or fast forward during playback, the track will automatically start to play.

Selecting a folder

For MP3/WMA files, press the [DISPLAY] button to switch the display indication to the folder number, then press the [FOLDER] (</>) buttons to select the desired folder number. The Track Number indicator displays "1."

Tips:

- Select the desired track or folder number while the unit is stopped so that playback will start with the desired track.
- For more information on the MP3/WMA folders and files, refer to page 25.

Advanced Playback from a CD or USB Flash Drive

Playback Pitch Control

You can change the playback pitch (speed) by pressing the PITCH [SLOW] or PITCH [FAST] buttons. To restore the normal pitch (speed), press the PITCH [NORMAL] button.

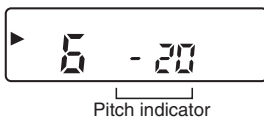

When you press the PITCH [SLOW] or [FAST] button, the indicator will change to the pitch indicator. (A minus symbol (–) appears if the speed is slower than the original.) You can adjust the pitch in the range of –50% to +100%, in 5% steps for the range of –50% to 0%, and 10% steps for the range of 0% to +100%.

CAUTION:

- If you open the disc cover, disconnect the USB flash drive, or turn of the power to the unit, the pitch returns to normal.
- During recording the pitch (speed) returns to normal and the Pitch Control function is disabled.
- If you change the pitch (playback speed) of an MP3/WMA file that uses a high bit rate to a very high positive number, the playback may sometimes skip. If you plan to change the playback speed to a value close to +100%, we recommend that you use files that feature a relatively low bit rate (for example, 128kbps).

Repeat Playback

You can set Repeat Playback using the [REPEAT] button.



Pressing the [REPEAT] button repeatedly cycles through the following options:

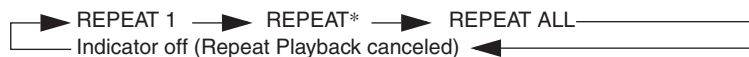

* You cannot select "REPEAT" for music CD playback.

"REPEAT 1" plays only the current track repeatedly. "REPEAT" plays tracks in the current folder repeatedly.

"REPEAT ALL" plays all tracks repeatedly.

You can combine Repeat Playback (excluding "REPEAT 1") with Random Playback.

Random Playback

You can set Random Playback using the [RANDOM] button.



Pressing the [RANDOM] button repeatedly cycles through the following options:



* You cannot select "RANDOM" for music CD playback.

"RANDOM" plays tracks in the current folder randomly. "RANDOM ALL" plays all tracks randomly.

Random Playback will stop after all tracks are played. However, you can combine Random Playback with Repeat Playback to play tracks repeatedly and randomly.

CAUTION:

- If you programmed the unit to play tracks, you cannot use the Random Playback function.

Program Playback

You can program the unit to play up to 25 tracks in the programmed order. Programming should be performed when the unit is stopped and the Resume function is canceled. Also, cancel the Random Playback function if it has been set.

I Press the [PROG.] button.



The **MEMORY** indicator lights up. If no track is programmed, the unit displays "P-00." If some tracks have already been programmed, the unit displays an indicator that prompts you to check the programmed tracks. Refer to the "Checking, deleting and adding programmed tracks" on the lower half of next page.

2 **Music CD**

Use the [SKIP] buttons to select a track to program.



The selected track number and playback time appear.

MP3/WMA (CD/USB)

Use the [SEARCH/FOLDER] buttons to select a folder, then use the [SKIP] buttons to select a track to program.



The selected track number and folder number appear.

3 Press the [PROG.] button.



The selected track is programmed to P-01.

4 Continue programming, if necessary.

Repeat steps 2 and 3. You can program up to 25 tracks (up to P-25).

5 Press the [PLAY/PAUSE] button.



Playback starts from the track programmed as P-01.

The **MEMORY** indicator turns off and the **PROGRAM** indicator turns on. The **PROGRAM** indicator turns on if any track has been programmed.

Checking, deleting and adding programmed tracks

1 Stop playback to cancel the resume function, then press the [PROG.] button.



The **PROGRAM** indicator flashes. The track number and the program number appear. Then the playback time or the folder number appears.

2 Press the [SEARCH] buttons.

Check the programmed tracks by pressing the [SEARCH] buttons repeatedly to increase or decrease the program number.

When you finish checking the tracks, press the [PROG.] button or wait five seconds without operating the unit.

3 To add or delete programmed tracks, press the [STOP/CLEAR] button while checking the programmed tracks.



The **MEMORY** indicator turns on, and the unit enters programming/deleting mode. The last programmed track number and its P (Program) number appear.

4 To delete programmed tracks, press the [STOP/CLEAR] button.

Repeatedly pressing the [STOP/CLEAR] button will delete the last programmed track one by one, and the previous program number will appear on the display. When all programmed tracks are deleted, the **PROGRAM** indicator turns off.

To add a track, repeat the steps described in Steps 2 and 3 in the “Program Playback” section.

5 Press the [PLAY/PAUSE] button.

Program Playback starts from track P-01.

CAUTION:

- All programmed data will be cleared when you open the disc cover, disconnect the USB flash drive, or turn off the power to the unit.
- To play back tracks normally, delete all programmed tracks so that the **PROGRAM** indicator will turn off.

Listening to a Tape

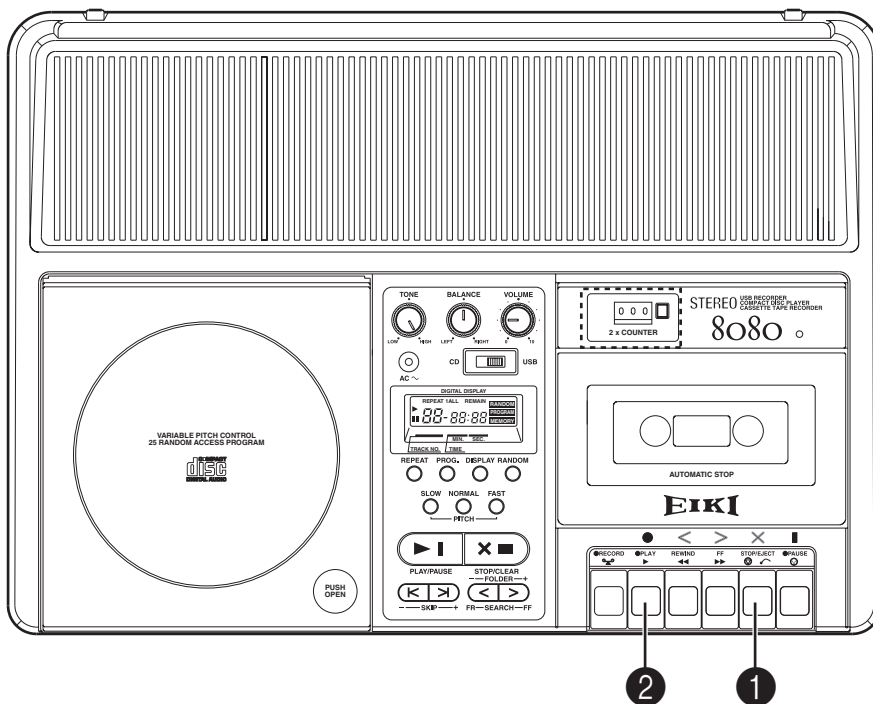

■ About the tape counter

The tape counter indicates the approximate amount of tape transport. Press the counter reset button to reset the counter to "000."

tape counter/counter reset button

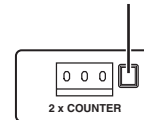

1 Load a cassette tape.

1 Press the [STOP/EJECT] button to pop open the cassette holder.

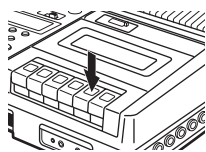

2 Insert a tape so that the side you want to record will face up and the exposed tape will face toward you.

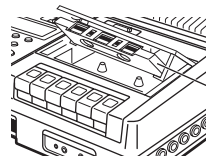

Place the tape on top of the guides.

3 Close the cassette holder.

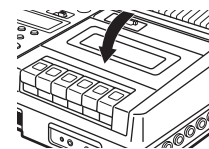

2 Press the [PLAY] button.



Adjust the volume level.

CAUTION:

- The [CD/USB] Input Select switch can be set to either [CD] or [USB].
- When tape playback starts, CD or USB playback will stop.
- During tape playback, you cannot play a CD or files on the USB flash drive.

Stopping the tape playback

Press the [STOP/EJECT] button.
Press the [STOP/EJECT] button again to eject the cassette tape.

Pausing the tape playback



Press the [PAUSE] button.
Press the [PAUSE] button again to resume playback.

Rewinding or fast forwarding the tape

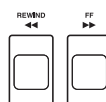

Press the [REWIND] or [FF] button respectively.

Press the [STOP/EJECT] button at the desired position.

CAUTION:

- Before you press any tape transport button, press the [STOP/EJECT] button to stop the tape.
- When the tape reaches the end, the automatic stop mechanism will stop the transport operation and the button that has been depressed will return to its original position. Do not press the button again.

Recording to a USB Flash Drive

Recording from a CD to a USB Flash Drive

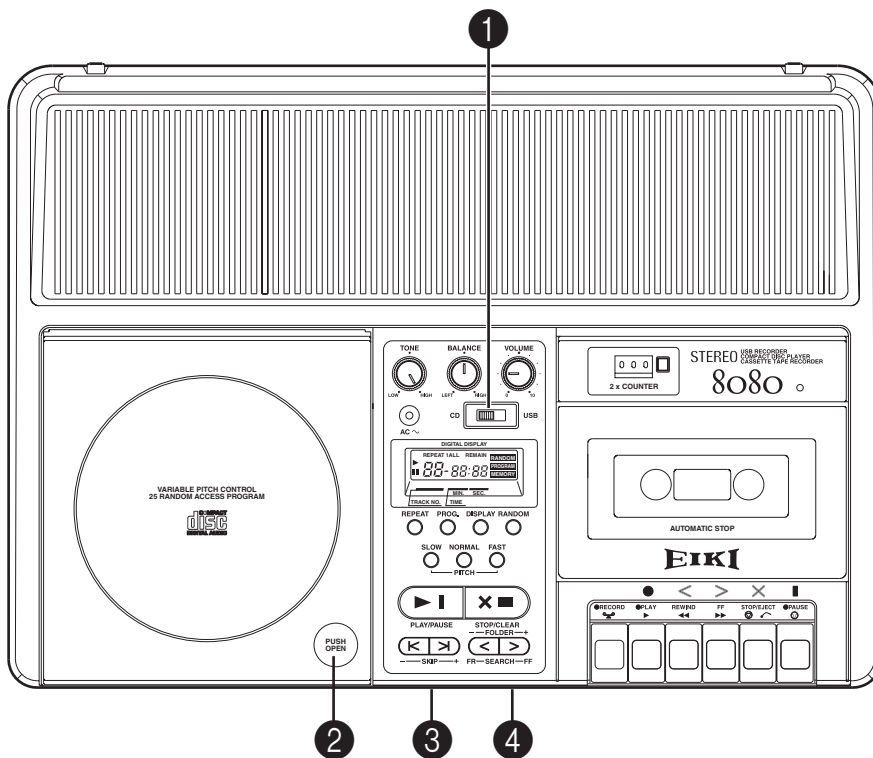

NOTE:

Tracks will automatically be recorded to available space on the drive.

You do not have to locate the appropriate position to record (as you would with a cassette tape).

1 Set the Input Select switch to [CD].

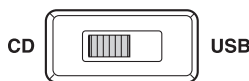

2 Insert a music CD.

See page 13.

CAUTION:

- MP3/WMA files on a CD cannot be recorded to the USB flash drive.

3 Connect the USB flash drive to the [USB] port.

See page 13.

4 Press the USB [REC] button.

The button lights up red, the CD automatically starts playing, and recording starts.

Tips:

- Recording tracks from a CD will create a separate file for each track.

Stopping recording

Press the [STOP/CLEAR] button.

Starting recording from the desired track

Select or start playing back the desired track on the CD, then press the USB [REC] button. Recording will start from the selected track. If you pressed the USB [REC] button during playback, the beginning of that track will be located, then recording will start.

CAUTION:

- During recording from a CD to a USB flash drive, the transport controls, such as pause, skip, fast rewind and fast forward, are disabled.
- Tracks will be recorded to the USB flash drive in MP3 format with a bit rate of 128kbps. You cannot change this setting.
- Please refer to page 25 for information on the folders and files that are created during USB recording.
- Changing the volume, tone, or balance during recording will not affect the recording.

2X Recording from a CD to a USB Flash Drive

The 8080 enables you to record tracks from a music CD to a USB flash drive at 2X speed. At this time, Mic Mixing recording (see page 22) is disabled.

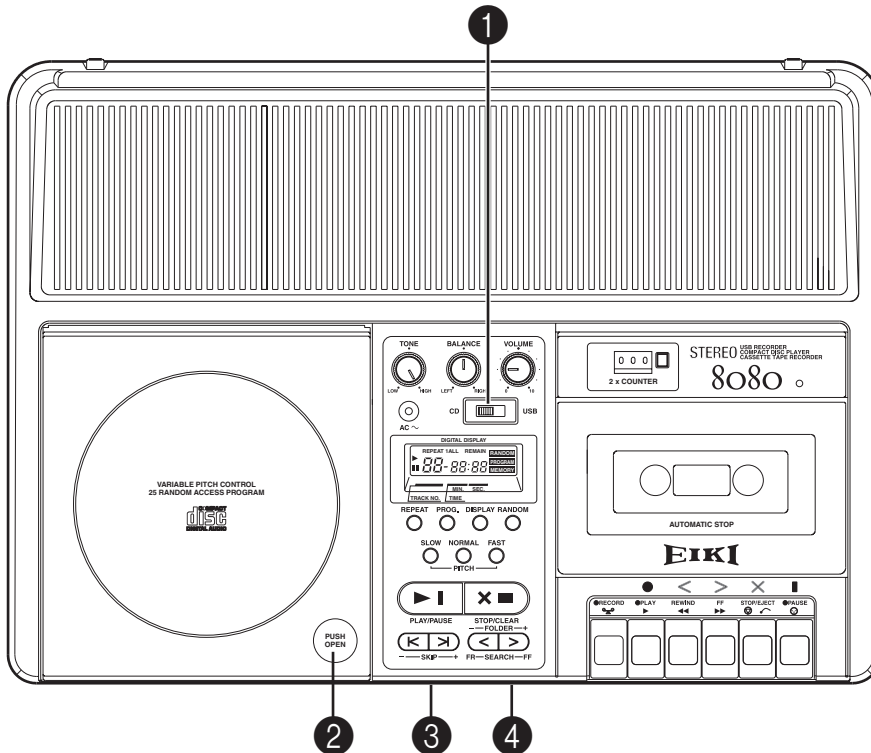

NOTE:

Tracks will automatically be recorded to available space on the drive. You do not have to locate the appropriate position to record (as you would with a cassette tape).

1 Set the Input Select switch to [CD].

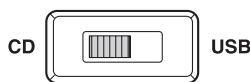

2 Insert a music CD.

See page 13.

CAUTION:

- MP3/WMA files on a CD cannot be recorded to the USB flash drive.

3 Connect the USB flash drive to the [USB] port.

See page 13.

4 Press the USB [REC] button twice within one (1) second.

The button lights up red, the CD automatically starts playing, and recording starts. The playback sound will be muted during 2X recording.

CAUTION:

- Recording tracks from a CD will create a separate file for each track.

Stopping recording

Press the [STOP/CLEAR] button.

If you press the [STOP/CLEAR] button while a track is playing, that track will be deleted and will not be recorded on the USB flash drive.

CAUTION:

- The transport controls, such as pause, skip, fast rewind and fast forward, are disabled during 2X-speed recording from a CD to a USB flash drive.
- Tracks will be recorded to the USB flash drive in MP3 format with a bit rate of 128kbps. You cannot change this setting.
- Please refer to page 25 for information on the folders and files that are created during USB recording.
- Changing the volume, tone, or balance during recording will not affect the recording.

Start recording from the desired track

Select or start playing back the desired track on the CD, then press the USB [REC] button twice within one (1) second. Recording will start from the selected track. If you pressed the USB [REC] button during playback, the beginning of that track will be located, then recording will start.

Recording from a Cassette Tape to a USB Flash Drive

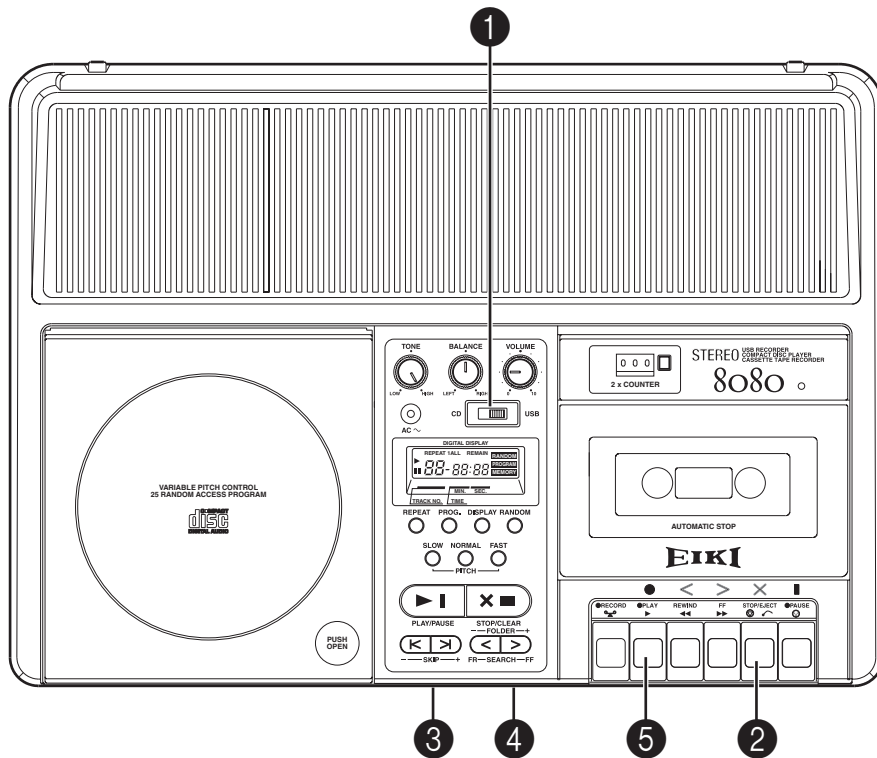
**NOTE:**

Tracks will automatically be recorded to available space on the drive. You do not have to locate the appropriate position to record (as you would with a cassette tape).

1 Set the Input Select switch to [USB].

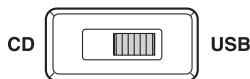

2 Insert a cassette tape.

See page 16.

3 Connect the USB flash drive to the [USB] port.

See page 13.

4 Press the USB [REC] button.

The button blinks red, and the unit enters record ready mode.

5 Press the [PLAY] button in the tape transport section.

The tape starts playing, and the USB flash drive automatically starts to record (the USB [REC] button lights up red).

Tips:

- Pressing the [PLAY/PAUSE] button during record ready mode will also start recording.
- Pressing the USB [REC] button while recording will place a track mark (track divider) in the position where you pressed the button.

Stopping recording

Press the [STOP/EJECT] button in the tape transport section. Alternatively, press the [STOP/CLEAR] button, then press the [STOP/EJECT] button in the tape transport section.

CAUTION:

- If you press the USB [REC] button while the tape is playing, recording will start immediately.
- Audio will be recorded to the USB flash drive in MP3 format with a bit rate of 128kbps. You cannot change this setting.
- Please refer to page 25 for information on the folders and files that are created during USB recording.
- Changing the volume, tone, or balance during recording will not affect the recording.

Recording to a Cassette Tape

Recording from a CD to a Cassette Tape

Use a TYPE I (Normal) cassette tape for recording.

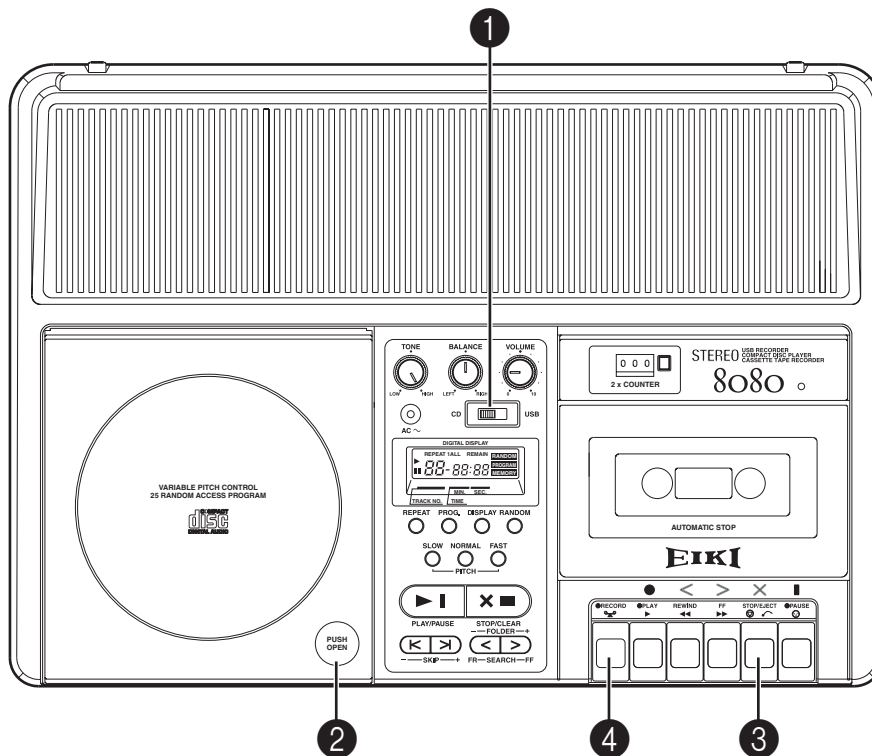

1 Set the Input Select switch to [CD].

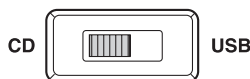

2 Insert a CD.

See page 13.

3 Insert a cassette tape.

See page 16.

4 Press the [RECORD] button in the tape transport section. (The [PLAY] button will also be pushed in automatically.)

The CD will start playing in a few seconds and the tracks will be recorded to the tape.



Stopping recording

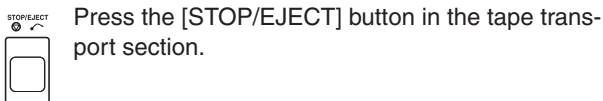

Press the [STOP/EJECT] button in the tape transport section.

Starting recording from the desired track

Select or start playing back the desired track on the CD, then press the [RECORD] button in the tape transport section. Recording will start from the selected track. During playback, the beginning of that track will be located, then recording will start.

Tips:

- If you record something on a previously-recorded tape, the existing recordings will be deleted. If you want to delete recordings on a tape without recording new audio, place the tape transport section into record mode without loading a CD.
- Changing the volume, tone, or balance during recording will not affect the recording.

Recording from a USB Flash Drive to a Cassette Tape

Use a TYPE I (Normal) cassette tape for recording.

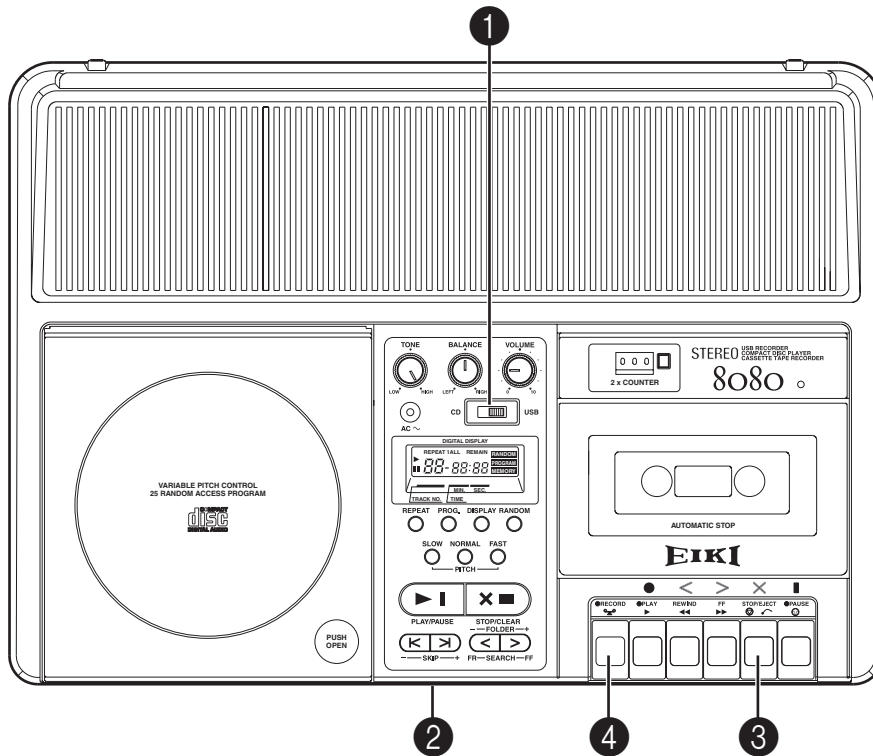

1 Set the Input Select switch to [USB].

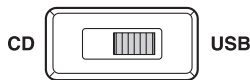

2 Connect a USB flash drive.

See page 13.

3 Insert a cassette tape.

See page 16.

4 Press the [RECORD] button in the tape transport section. (The [PLAY] button will also be pushed in automatically.)

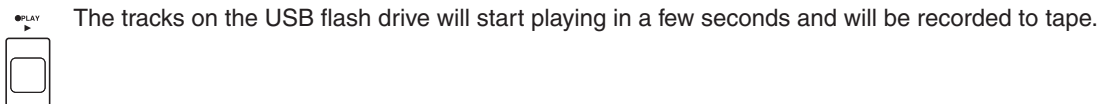

Stopping recording

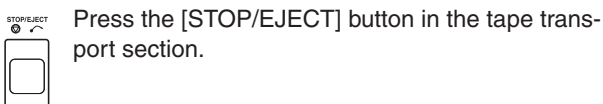

Starting recording from the desired track

Select or start playing back the tracks on the USB flash drive, then press the [RECORD] button in the tape transport section. Recording will start from the selected track. During playback, the beginning of that track will be located, then recording will start.

Tips:

- If you record something on a previously-recorded tape, the existing recordings will be deleted. If you want to delete recordings on a tape without recording new audio, place the tape transport section into record mode without connecting the USB flash drive to the unit.
- Changing the volume, tone, or balance during recording will not affect the recording.

Using a Microphone or External Device

Mic Mixing Recording

Mic Mixing Recording function enables you to mix audio signals from a connected microphone with the audio playback signals from the CD, USB flash drive or tape. (This function is not available during 2X-speed recording from a CD to a USB flash drive.)

- 1 **Connect a microphone to the [MIC] connector. (See page 11.)**
- 2 **Set up and start recording.**
- 3 **Input the sound you want to mix from a connected microphone.**

Tips:

- To record only the mic sound to a cassette tape, perform the CD to tape recording procedure without loading a CD. You could also perform the USB to tape recording procedure without connecting a USB flash drive.
- To record only the mic sound to a USB flash drive, prepare a cassette tape to USB flash drive recording, press the USB [REC] button to place the unit in record ready mode, then press the [PLAY/PAUSE] button to start recording.
- If you are using a microphone with a built-in remote switch, first turn the switch on, then start recording. Once recording starts, you can pause and resume recording by turning the remote switch off and on. (This function does not apply to a CD to USB flash drive recording or to a 2X-speed recording.)

CAUTION:

- If the volume level is too high, feedback may occur. In this case, locate the microphone away from the speakers or lower the volume level.
- In general, turn the remote switch on. If the switch remains turned off, you will be unable to control recording or playback.

Mic Mixing Playback (Microphone Amplification)

You can amplify the microphone input volume. At this time, the mic input will be mixed with the playback of the CD, USB flash drive or cassette tape.

- 1 **Connect a microphone to the [MIC] connector. (See page 11.)**
- 2 **Set up and start playback.**
- 3 **Input the sound you want to mix from a connected microphone.**

Tips:

- To amplify only the mic sound, pause the tape playback after playback starts. If you are playing a CD or a file from a USB flash drive, turn the remote switch on the microphone off.
- If you are using a microphone with a built-in remote switch, first turn the switch on, then start playback. Once playback starts, you can pause and resume playback by turning the remote switch off and on.

CAUTION:

- You must play or pause the playback source to amplify the microphone input volume.
- If the volume level is too high, feedback may occur. In this case, locate the microphone away from the speakers or lower the volume level.
- In general, leave the remote switch turned on. If the switch remains turned off, you will be unable to control playback.

Using an External Device

You can play back or record sound input from a connected external device in the same way as Mic Mixing Recording and Playback.

- 1 Connect a device to the [AUX IN] connector. (See page 11.)**
- 2 Set up and start playback or recording.**
- 3 Play the external device.**

Tips:

- The sound from an external device will be mixed with the playback sound of the 8080. If you want to play or record only the sound of the external device, refer to the Tips in the “Mic Mixing Playback (Microphone Amplification)” and “Mic Mixing Recording” sections.

CAUTION:

- You cannot use the [MIC] connector and the [AUX IN] connector at the same time. Remove the microphone from the [MIC] connector if you plan to use the [AUX IN] connector.
- The [AUX IN] connector accepts a monaural signal. Signals from a connected external device will be mixed with the playback sound of the 8080 in monaural.

Supported Discs, USB Devices, and Files

Supported Discs

The 8080 supports playback of 8 cm and 12 cm CDs with the following logo.



- Eiki does not guarantee the operation of the unit if you use discs that do not comply with the compact disc standards.
- Do not use discs that feature a non-standard shape, such as a heart shape. Otherwise, the unit may malfunction.

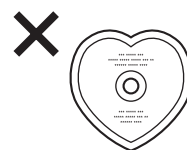

■ About CD-R and CD-RW discs

- CD-R and CD-RW discs must be finalized before they can be used in the unit.
- The 8080 supports CD-R and CD-RW discs formatted as a music CD (CD-DA) or in MP3/WMA format. However, certain CD characteristics, recording conditions, or dirt on the optical pickup lens can also affect playback.

Supported USB Devices

The 8080 supports USB flash drives that comply with USB Mass Storage Class standards. The USB flash drive format supports FAT and FAT32.

CAUTION:

- Do NOT remove the USB flash drive or unplug the unit while the unit is accessing the USB flash drive.
- Eiki does not guarantee the operation and power supply of all types of USB flash drives.
- Eiki will not be liable for the damage or loss of any data that is stored on a USB flash drive that is caused by connection of such drive to the 8080.

Supported Files on a CD and USB Flash Drive

The 8080 supports the following file formats:

Format	Bit Rate	Sampling Frequency	File Extension
MP3	8kbps – 320kbps, VBR	16kHz, 22.05 kHz, 24 kHz 32kHz, 44.1kHz, 48kHz	.MP3 .mp3
WMA	48kbps – 192kbps, VBR	32kHz, 44.1kHz, 48kHz	.WMA .wma

VBR: Variable Bit Rate

CAUTION:

- You cannot play WMA files that are protected by copyright.
- Some files may not play correctly, depending on the combination of the bit rate and sampling frequency.
- If you cancel a 2X-speed CD to USB flash drive recording in the middle of the first track, no track file will be recorded. Only an empty folder will be created.
- MP3/WMA tag information is not supported.
- WAV format is not supported.
- MP3i and mp3PRO formats are not supported.
- WMA9 Pro, WMA9 Lossless and WMA9 voice formats are not supported.
- The format of files recorded to a USB flash drive is MP3 (128kbps, 44.1kHz) and cannot be changed.

About Folders and Files

File Playback Sequence

The 8080 loads the folders (that contain MP3/WMA files) starting with the highest level of the folder hierarchy. Within the same level of the hierarchy, the 8080 loads folders in the numerical order.

The folder numbering format is “F-00” (where “00” is a two-digit number), as shown in the example diagram below.

Folders that do not contain any MP3/WMA files will not be numbered.

The 8080 reads and plays back files in a folder in numerical order.

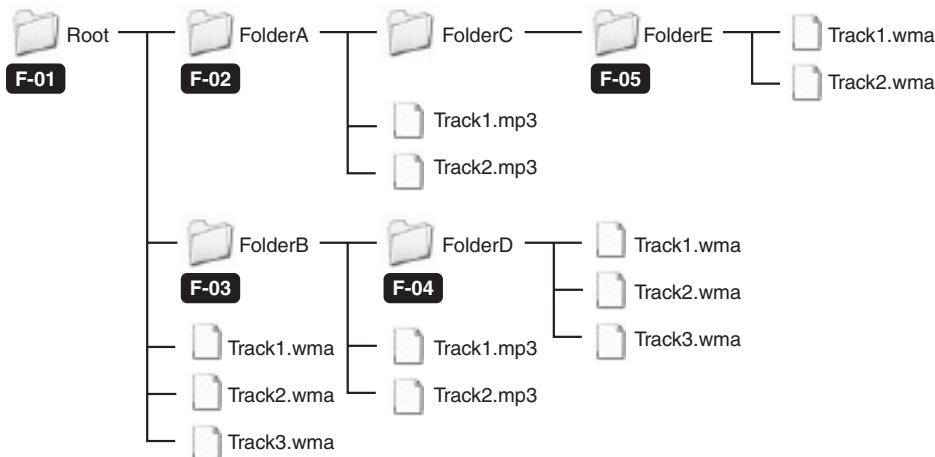

CAUTION:

- Folders and files will be read in the numerical order. However, the playback sequence will not necessarily be the same as the recording sequence.
- If no folders exist (that is, only the root exists) the root will be numbered as “F-01.”
- The unit recognizes up to 99 MP3/WMA files at the root level or in each folder, and ignores any additional files.

Folders and Files Created during Recording

Each time you make a recording after the unit is stopped, the 8080 will create a new folder.

During recording from a CD to a USB flash drive, a file will be created for each track. On the other hand, during recording from a tape to a USB flash drive, one recording session will create one file, unless you place track marks or pause the recording.

CD → USB flash drive

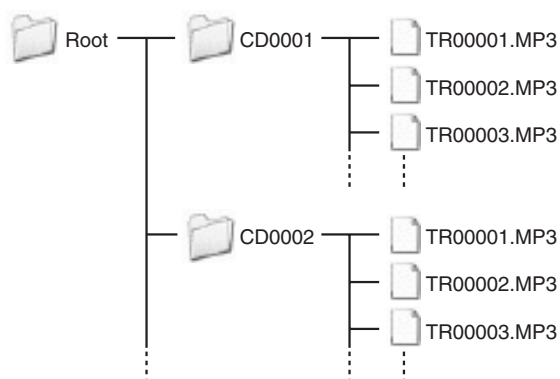

Tape → USB flash drive

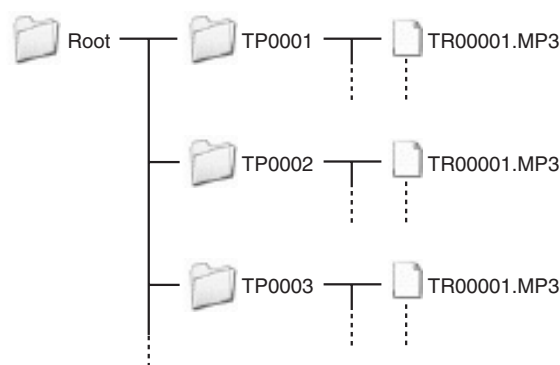

CAUTION:

- The folder number or track number on the CD or tape does not necessarily correspond to the folder name or file name on the USB flash drive. (Please refer to the “File Playback Sequence” above.)
- You cannot change the folder or file names, or delete or move the files using the 8080. Connect the USB flash drive to your computer and use the computer to change the folder or file names, or delete unnecessary files.

About CD and Cassette Tape

Handling CDs

■ Holding a disc

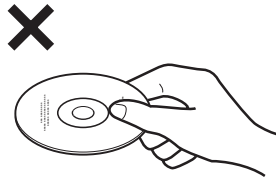
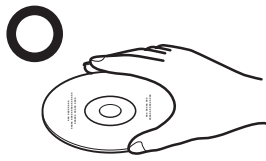

Do not touch the playback side.

Handle the disc carefully by holding it by its edges. Do not touch the playback side (non-label, shiny side).

■ Cleaning a disc

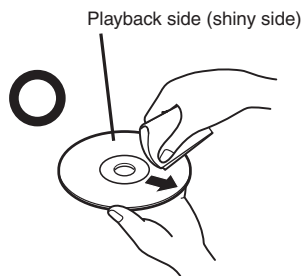

From inside to outside

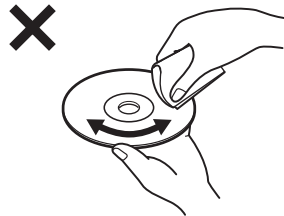

Use a soft, dry cloth to wipe dust and fingerprints off the surface of a CD. Wipe from the center toward the perimeter.

Don't use vinyl record cleaners or antistatic agents. Do not use volatile agents, such as thinner or benzene.

■ Removing condensation

Moisture condensation may form inside the 8080, affecting the performance of the unit, if:

- The unit is moved from a cold place to a warm place.
- A heater is turned on, or cold air from an air conditioner is hitting the unit.

If condensation does form, remove the disc and leave the unit turned on for an hour before using.

■ Other precautions for handling discs

- Do not use a pencil or ball point pen to write on the surface of a disc.
- Do not use discs that have a residue of adhesives or rental discs with peeling labels.
- Do not leave a CD in direct sunlight or in locations subject to heat, such as near a heater.

Handling Cassette Tapes

■ Recommended cassette tapes

- Use a TYPE I (Normal) tape. Using other types of tape may cause the unit to record or delete audio incorrectly.
- Do not use tapes that are longer than 90 minutes in duration. These tapes are thin and can easily get caught on the pinch rollers or capstans.

■ Loose tape

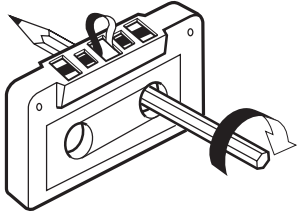

Loose tape can easily be damaged or cut. Remove any tape slack with a pencil or similar device as shown in the figure.

■ Preventing important recordings from being erased accidentally

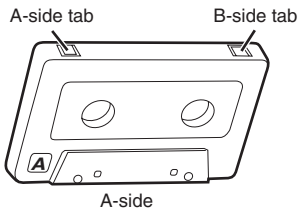

Break off the erasure prevention tab(s) using a small flat-head screw driver or similar tool.

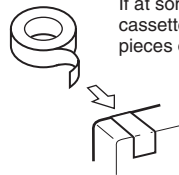

If at some later date you wish to record the cassette, simply cover the hole(s) with small pieces of cellophane tape.

■ Other precautions for handling cassette tapes

- Do not apply labels in locations not specified on the tape.
- Do not place tapes near magnetic sources (speakers, TVs, etc.) Otherwise, important recordings might be erased or damaged.
- Do not expose cassette tapes to direct sunlight, high temperature or high humidity.

NOTE:

Recording copyrighted material is illegal without the permission of the copyright holder, although you may copy purchased or broadcast recordings if the duplicate is exclusively for your personal use.

Appendix

Maintenance

■ Cleaning the unit

Dust the unit with a soft cloth. For stubborn dirt, use a soft cloth dampened with a weak solution of mild detergent and water. Dry the unit immediately afterwards with a clean, dry cloth.

- Do not use thinners, alcohol, or other chemical solvents.
- If you are using chemical cleaning cloth, follow the instructions for using the cloth carefully.

■ Cleaning the optical pickup lens of the CD player

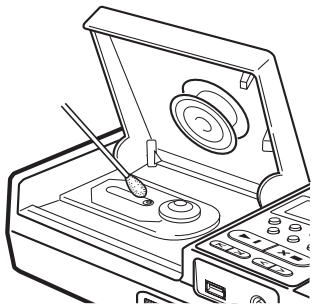

A dirty optical pickup lens on the CD player may cause the player to skip or become unable to play back. In this case, remove the power cord from the AC outlet, then use a cotton swab to lightly wipe the dirt off the lens or use a blower to blow the dust off.

- Do not apply too much force when you clean the lens. Otherwise, the CD player may malfunction.

■ Cleaning the head of the cassette tape recorder

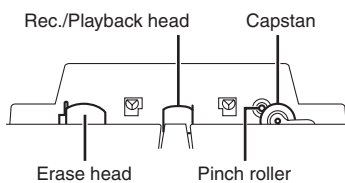

As you use the cassette tape recorder, magnetic particles accumulate on the recording/playback head, leading to a greatly diminished sound quality, decreased volume, or incomplete recording. Use a commercially available cleaning kit to clean the erase head, record/playback head, pinch rollers and capstans every 10 hours of operation.

Troubleshooting

If you have any trouble using the 8080, look for a solution here before you contact your Eiki dealer for repair.

	Symptoms	Causes	Actions	See page:	
Common section	The power indicator does not light up.	<ul style="list-style-type: none"> The power cord plug is disconnected from the AC outlet. 	<ul style="list-style-type: none"> Insert the power cord plug into the AC outlet securely. 	9	
	The sound is barely heard.	<ul style="list-style-type: none"> The volume setting is too low. 	<ul style="list-style-type: none"> Raise the [VOLUME] knob setting to an appropriate level. 	10	
	No sound is heard from the built-in speaker.	<ul style="list-style-type: none"> The headphones or external speakers are connected. 	<ul style="list-style-type: none"> Disconnect all the headphones and external speakers. 	11	
	Noise is heard.	<ul style="list-style-type: none"> A device that is emitting electronic waves (such as a cell phone) is being used in the vicinity. 	<ul style="list-style-type: none"> Move such a device away from the unit. 	–	
CD player section	Playback does not start.	<ul style="list-style-type: none"> A cassette tape is still playing. There is no file to play back on the CD. 	<ul style="list-style-type: none"> The tape recorder section has the higher priority for playback. Stop the tape playback, then play the CD. Insert a CD that contains supported MP3 or WMA files. 	13 24	
	“NO DISC” appears on the display even though a disc is inserted.	<ul style="list-style-type: none"> The CD is inserted upside down. The CD is very dirty. The CD player’s optical pickup lens is very dirty. Condensation has formed on the optical pickup lens. No recordings on the CD-R/CD-RW. The CD-R/CD-RW has not been finalized. Depending on the disc characteristics or recording conditions, some CD-R/CD-RW discs might not play. 	<ul style="list-style-type: none"> Insert the CD with its label side facing up. Wipe the dirt off the CD surface. Clean the CD player’s optical pickup lens. Leave the unit with the power turned on for an hour to remove condensation. Insert a CD-R/CD-RW that contains recordings. Finalize the CD-R/CD-RW. Change the disc. 	13 26 28 26 24 24	
	Playback skipping or noise	<ul style="list-style-type: none"> The CD is very dirty. The CD surface has scratches. The CD player’s optical pickup lens is very dirty. Depending on the disc characteristics or recording conditions, skipping or noise may occur. The MP3 or WMA files are in an unsupported format. 	<ul style="list-style-type: none"> Wipe the dirt off the CD surface. Change the disc. Clean the CD player’s optical pickup lens. Change the disc. Play a CD that contains files in the supported format. 	26 28 24 24	
	The CD player takes a while to read the inserted CD.	<ul style="list-style-type: none"> It may take a while to read a disc that contains a larger number of files. 	<ul style="list-style-type: none"> Wait until the disc is completely read. 	–	
	Some files cannot be played.	<ul style="list-style-type: none"> WMA files that are protected by copyright cannot be played. The unit does not support WAV format. The MP3 or WMA files are in an unsupported format. The root level or the folder contains 100 or more MP3/WMA files. 	<ul style="list-style-type: none"> Play WMA files that are not protected by copyright. Play files that use the MP3 or WMA format. Play only files that use the supported format. The unit recognizes up to 99 files at the root level or in each folder. 	24 24 24 25	
	Playback sequence does not correspond to the track order.	<ul style="list-style-type: none"> The unit is in Repeat, Random, or Program Play mode. 	<ul style="list-style-type: none"> Cancel Repeat, Random, or Program Play mode. 	14, 15	

	Symptoms	Causes	Actions	See page:
USB recorder section	Playback does not start.	<ul style="list-style-type: none"> The cassette tape is still playing. There is no file to play back on the USB flash drive. 	<ul style="list-style-type: none"> The tape recorder section has the higher priority for playback. Stop the tape playback, then play the files on the USB flash drive. Connect a USB flash drive that contains supported MP3 or WMA files. 	13 24
	“NO USB” appears on the display even when a USB flash drive is connected.	<ul style="list-style-type: none"> The unit does not recognize the USB flash drive. The unit does not support the USB flash drive. 	<ul style="list-style-type: none"> Remove the USB flash drive, then connect it again. Use a different USB flash drive. 	24
	Some files cannot be played.	<ul style="list-style-type: none"> WMA files that are protected by copyright cannot be played. The unit does not support WAV format. The MP3 or WMA files are in an unsupported format. The root level or the folder contains 100 or more MP3/WMA files. 	Play WMA files that are not protected by copyright.	24
			Play files that use the MP3 or WMA format.	24
			Play only files that use the supported format.	24
			The unit recognizes up to 99 files at the root level or in each folder.	25
	Playback skipping or noise	<ul style="list-style-type: none"> The MP3 or WMA files are in an unsupported format. 	<ul style="list-style-type: none"> Play only files that use the supported format. 	24
	Playback sequence does not correspond to track order.	<ul style="list-style-type: none"> The unit is in Repeat, Random, or Program Play mode. 	<ul style="list-style-type: none"> Cancel Repeat, Random, or Program Play mode. 	14, 15
Playback sequence does not correspond to the recording order.	<ul style="list-style-type: none"> You have edited the file or folder on the computer. 	<ul style="list-style-type: none"> Tracks are played in the order of entry, not in the order in which they were recorded. 	24	
Tracks cannot be recorded from CD to USB flash drive.	<ul style="list-style-type: none"> You attempted to record tracks from an MP3 or WMA disc. 	<ul style="list-style-type: none"> Only music CDs are supported for recording to a USB flash drive. 	17, 18	
Tracks cannot be recorded.	<ul style="list-style-type: none"> The free space on the flash drive is less than 256KB. The root level contains a folder named “CD9999” or “TP9999.” 	<ul style="list-style-type: none"> Due to the limitations of the system, recording is unavailable if the free space on the drive is less than 256KB. Due to the limitations of the system, recording is unavailable if the root level contains a folder with a name that includes number 9999. 	—	
Tape recorder section	The cassette tape cannot be inserted.	<ul style="list-style-type: none"> The orientation of the cassette tape is wrong. 	<ul style="list-style-type: none"> Insert the tape so that the exposed tape is facing toward the front of the unit. 	16
	Low sound quality or noise	<ul style="list-style-type: none"> The record/playback head is dirty. 	<ul style="list-style-type: none"> Clean the head. 	28
	Tape is damaged or tangled.	<ul style="list-style-type: none"> The tape has too much slack. You did not press the [STOP/EJECT] button before pressing another transport control button. You are using a long tape that exceeds 90 minutes. 	Remove the tape slack, then insert the tape.	27
			<ul style="list-style-type: none"> Before switching the transport control, press the [STOP/EJECT] button. (e.g.,) [REWIND] → [STOP] → [PLAY] A long tape is thin and may easily become tangled with the capstans and rollers. Use a 90 minutes or shorter tape. 	16 27
	The [REC] button cannot be depressed.	<ul style="list-style-type: none"> The erase prevention tab on the tape has been removed. 	<ul style="list-style-type: none"> Check to see if the tab is broken. If you want to overwrite the tape, cover the erasure prevention hole with a piece of cellophane tape. 	27
The previous recording is not deleted completely.	<ul style="list-style-type: none"> The erase head is dirty. You are using a TYPE II (high-position) or TYPE IV (metal) tape. 	Clean the erase head.	28	
		Use a TYPE I (normal) tape.	27	

Specifications

■ CD player section

Frequency response	127 Hz – 20 kHz
Number of channels	2 channel stereo
D/A converter	1 bit (8fs digital filter)
Playback format	CD-DA, MP3, WMA

■ USB recorder section

Compliance	USB Mass Storage Class
Interface	USB 2.0 Full Speed
File system	FAT, FAT32
Playback format	MP3, WMA
Recording format	MP3 (128kbps)
Current supply	Max. 500mA

■ Cassette tape recorder section

Frequency response	125 Hz – 8 kHz
Track format	Compact cassette, stereo
Tape	Normal (TYPE I)

■ Common section

Maximum output	7W+7W (JEITA 4 Ω)	
Speakers	10cm, round type x 2	
Input connectors	USB x 1 Mic ø3.5 monaural x 1 Remote ø2.5 x 1 AUX ø3.5 monaural x 1	
Output connectors	Headphones ø6.3 stereo x 5	
	External speakers ø6.3 monaural	Left x 1, Right x 1
Power supply	North American: AC120V, 60 Hz European: 230V, 50 Hz Australian: 240V, 50 Hz	
Power consumption	North American: 28 W European: 33W Australian: 33W	
Dimensions	400 (w) x 100 (h) x 285 (d) mm	
Weight	3.7 kg	

- Specifications and features are subject to change without notice.

EIKI

U.S.A.

EIKI International, Inc.
30251 Esperanza
Rancho Santa Margarita
CA 92688-2132
U.S.A.
Tel : 800-242-3454 (949)-457-0200
Fax : 800-457-3454 (949)-457-7878
E-Mail : usa@eiki.com

Deutschland & Österreich

EIKI Deutschland GmbH
Am Frauwald 12
65510 Idstein
Deutschland
Tel : 06126-9371-0
Fax : 06126-9371-14
E-Mail : info@eiki.de

China

EIKI (Shanghai) Co., Ltd.
1. Dapu Road,
Golden Magnolia Plaza
#2109 Shanghai,
200023 China
Tel : 86-21-5396-0088
Fax : 86-21-5396-0318
E-mail : info@eiki-china.com

Canada

EIKI CANADA - Eiki International, Inc.
P.O. Box 156, 310 First St. - Unit 2,
Midland, ON, L4R 4K8, Canada
Tel : 800-563-3454 (705)-527-4084
Fax : 800-567-4069 (705)-527-4087
E-Mail : canada@eiki.com

Eastern Europe

EIKI CZECH SPOL. s.r.o.
Nad Cementárnou 1163/4a
Paraha 4, Podolí
147 00
Czech Republic
Tel : +42 02 4141 0928
+42 02 4140 3095
Fax: +42 02 4140 9435
E-Mail : easterneurope@eiki.de

South East Asia

EIKI Industrial (M) Sdn Bhd
No. 3A-2C, 4th Floor, Jalan PJU 8/3A,
Perdana Business Centre,
Bandar Damansara Perdana,
47820 Petaling Jaya, Selangor
Malaysia
Tel : +603-7722-4362
Fax : +603-7722-4392
E-Mail : sales@eiki.my

Japan & Worldwide

EIKI Industrial Company Limited.
4-12 Banzai-Cho, Kita-Ku, Osaka,
530-0028 Japan
Tel : +81-6-6311-9479
Fax : +81-6-6311-8486

WorldWide Website <http://www.eiki.com>

Free Manuals Download Website

<http://myh66.com>

<http://usermanuals.us>

<http://www.somanuals.com>

<http://www.4manuals.cc>

<http://www.manual-lib.com>

<http://www.404manual.com>

<http://www.luxmanual.com>

<http://aubethermostatmanual.com>

Golf course search by state

<http://golfingnear.com>

Email search by domain

<http://emailbydomain.com>

Auto manuals search

<http://auto.somanuals.com>

TV manuals search

<http://tv.somanuals.com>