

EIKI

MULTIMEDIA PROJECTOR

MODEL **EIP-25**

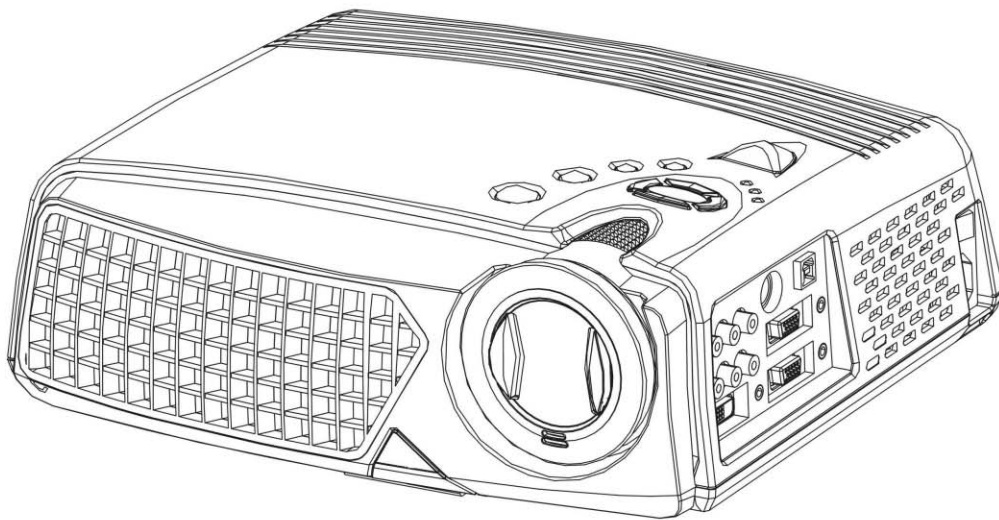

OWNER'S INSTRUCTION MANUAL

Table of Contents

1. Introduction	2
2. Features	2
3. Operation notice	3
4. Projector figure	4
4.1 Function list of control panel	4
5. Accessories	7
5.1 Remote control	8
5.2 Function list of remote control panel	9
6. Operation guide	11
6.1 Connecting component	11
6.2 How to connect the projector to your computer	12
6.3 How to connect the projector to a DVD or VCR	12
6.4 Turning on the projector	13
6.5 Basic Image Adjustment	13
6.6 Turning off the projector	14
6.7 Adjusting the projected image height	14
6.8 Adjusting the image focus and zoom	15
7. OSD menu	16
7.1 Image (Computer mode)	16
7.2 Image (Video mode)	17
7.3 Display (Computer mode)	18
7.4 Display (Video mode)	20
7.5 Audio	21
7.6 Projection setting	22
7.7 Language	23
8. Maintenance and service	24
8.1 Replacing the lamp module	24
8.2 Cleaning the projector lens	24
9. Appendix	26
9.1 Common problems and solutions	26
9.2 Distance ratio of screen and projector	28
9.3 Specifications	29

1.Introduction

Please read this manual carefully before using, to find out:











- How to use the projector safely
- How to use the remote control
- How to set up and connect the projector
- How to start and turn off the projector
- How to use the On-screen display (OSD) menus
- How to replace the lamp module
- How to solve troubleshoot common problems

2.Features

- Use the technology of chip TI 0.7"/ 0.6" DLP™.
- Full-function remote including mouse controls.
- High quality manual zoom lens.
- Weight only 7.5 pounds with beautifully designed appearance.
- Expandable module design, compact and lightweight.
- High brightness/high contrast. Clear images.
- Provide the adjustment of 4 : 3 / 16 : 9 aspect ratio.
- Compatible with the VGA of P- Scan (480P) & HDTV (1080i / 720P).
- Compatible with the video of NTSC / PAL / HDTV.
- Multi languages function window.

3.Operation notice:

Please read and follow the following safety instructions and description carefully. Inappropriate operation method may result in fire, electrical shock, and personal injury or shorten the life span of projector.

-  Warning: Do not cover the lens while the lamp lights up.
-  Warning: To protect your eyes, do not look directly into the projector's light source.
-  Warning: Make sure that you provide adequate ventilation for the projector. Do not block the ventilation holes in the case
-  Warning: To prevent electrical shock, never open the projector case.
-  Warning: Before using, please make sure that the power cord is connected to an AC receptacle with a protective safety ground terminal. Do not neglect the receptacle with protective safety ground terminal.
-  Warning: To replace the lamp, turn the projector off and unplug the power cord. To avoid burns, wait 1 hr before opening the lamp door. For relevant operation procedures, please refer to page 24 the section of “changing lamp”.
-  Warning: Please use the power cord provided. And use the receptacle with a protective safety ground terminal.
-  Warning: Do not block ventilation openings to avoid danger.
-  Warning: Do not place any drinks on top of your projector. Spilled liquids may damage the projector.
-  Warning: Do not place the projector on a hot surface, moisture or in direct sunlight.
-  Warning: Handle carefully during transportation. Avoid dropping it.

4. Projector figure

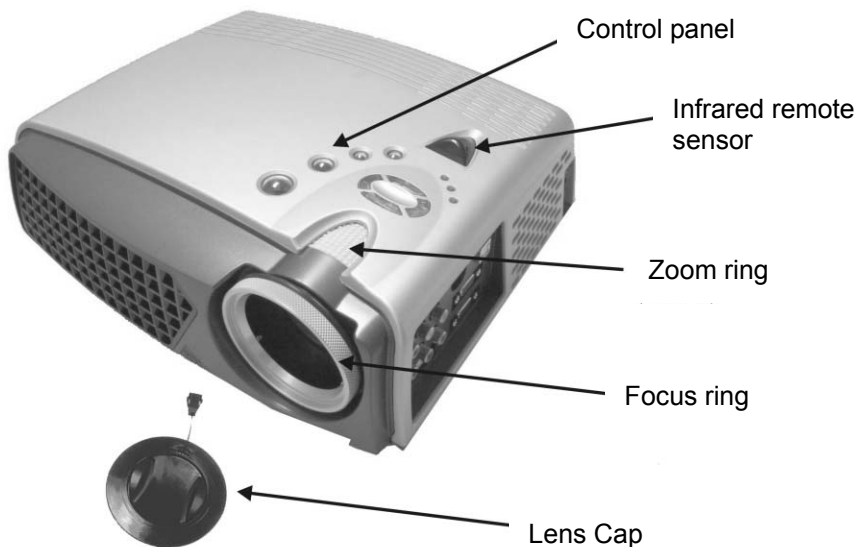

4.1 Function list of control panel:

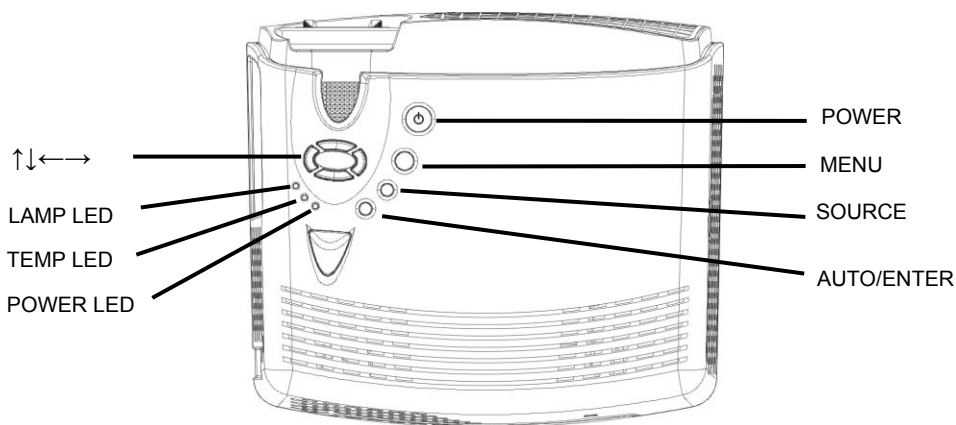

Power LED (Indicator light)

- When the projector is on, Power LED will blink. Press “Power” button to enter screen, Power LED remains lit continually.

Temp LED (Indicator light)

- When fan malfunctions, the screen will shows the message stating “fan error, system is forced to turn off!”. Temp LED remains lit continually.
- When the temperature is unusual, screen will shows the message stating “temperature error, system is forced to turn off!”. Temp LED blinks once every **half** of second.

Lamp LED (Indicator light)

- **Lamp LED will turn on automatically when lamp is on. Lamp LED will turn off automatically when the lamp is off.**

Power (On/Standby)

- Press to turn power off and on.
- Please refer to the “Starting and turning off the projector” section in Page 13.

Menu (OSD menu)

- Press this button to display the menu, press once again to close the menu.
- If no other action is taken after the menu is opened, it will disappear automatically after 20 sec.

Source (Signal source)

- Select the signal of Analog RGB, Analog Y Pb Pr, Digital RGB, Composite Video, S-Video and Component Video in proper order, and automatically adjust the phase and frequency.

Auto/Enter (confirm/Sync)

- When using menu, this button is the Enter function.
- Under general condition, this button is the Sync function.

↑↓ (Up and down button)

- OSD active: Press to move between menu options.
- OSD inactive: Press to select the video input source.

←→(Left and right button)

- When using these buttons, press "Auto/Enter" button then press right key to add setting value; on the contrary, left button to reduce the setting value.

5. Accessories

You should check to make sure the accessories below are complete with nothing missing. For any missing accessory, please contact the local distributor.



Projector lens cap



power cord



Component Video cable



Composite Video cable



PC Audio in/out cable



S-Video cable



VGA cable



USB cable



Carry bag



VGA - RCA cable



DVI cable



remote control & 2 AAA batteries

5.1 Remote Control

The infrared sensor is located on the top of the projector. The distance between the sensor and remote control should not exceed 10 meters for the remote control to function correctly.



How to insert batteries in the remote control:



- 1) Remove the battery compartment cover.
- 2) Insert two AAA batteries into the battery compartment. Ensure the batteries polarity is aligned correctly.
- 3) Replace the battery compartment cover.

- Using remote control



5.2 Function list of remote control panel:

Function key	Function description
Freeze/Esc/L	<ul style="list-style-type: none"> • OSD inactive: press this button to freeze the display image. Press again to resume motion. • OSD active: press this button to exit. • Mouse active: Use as the left mouse button.
Enter/R	<ul style="list-style-type: none"> • During common status or using OSD options, please refer to “Auto/Enter” of “Projector panel” in page 5. • Mouse active: Use as the right mouse button.
Power 	<ul style="list-style-type: none"> • Please refer to “Turning on and turning off the projector” section in page 13.
Mode	<ul style="list-style-type: none"> • Press “Mode” button to make LED light become green. At this time, the remote control presents mouse status and capable of simulating mouse. • If no action is input within 15 sec, remote control will return to common status automatically. Please press “Mode” button again to return to mouse mode. • You must have USB cable connected between your computer and the projector to use this option.
Menu	<ul style="list-style-type: none"> • Please refer to “Menu” of “Projector panel” in page 5.
Source	<ul style="list-style-type: none"> • Select the signal of Analog RGB, Analog Y Pb Pr, Digital RGB, Composite Video, S-Video and Component Video in proper order.
Blank	<ul style="list-style-type: none"> • Press to set the current image into a plain blue screen. Press again to restore the display image.
Auto	<ul style="list-style-type: none"> • This button can automatically adjust the picture position and frequency.
Pg.Up 	<ul style="list-style-type: none"> • Use as display image magnifying (*). • Mouse active: Use as Page up cursor.
Pg.Dn 	<ul style="list-style-type: none"> • Use as display image minifying (*). • Mouse active: Use as Page down cursor.

	<ul style="list-style-type: none"> • Press this button, then press right and left button to execute keystone correction. • Press ← button to correct a display image that is wider at the bottom. • Press → button to correct a display image that is wider at the top.(*) • Do not activate when displaying text or spreadsheets to eliminate text distortion.
	<ul style="list-style-type: none"> • OSD inactive: The same as the Up, Down, Left, Right control button on the panel. (*) • Mouse active: Use as the Up, Down, Left, Right button of mouse.

Press “Auto” button to return to previous setting value.

6.Operation guide

6.1 Connecting components

You can connect the projector to your computer, DVD player or VCR. To connect the projector to a DVD player or VCR, go to “Connecting to a DVD player or VCR” on page 12.

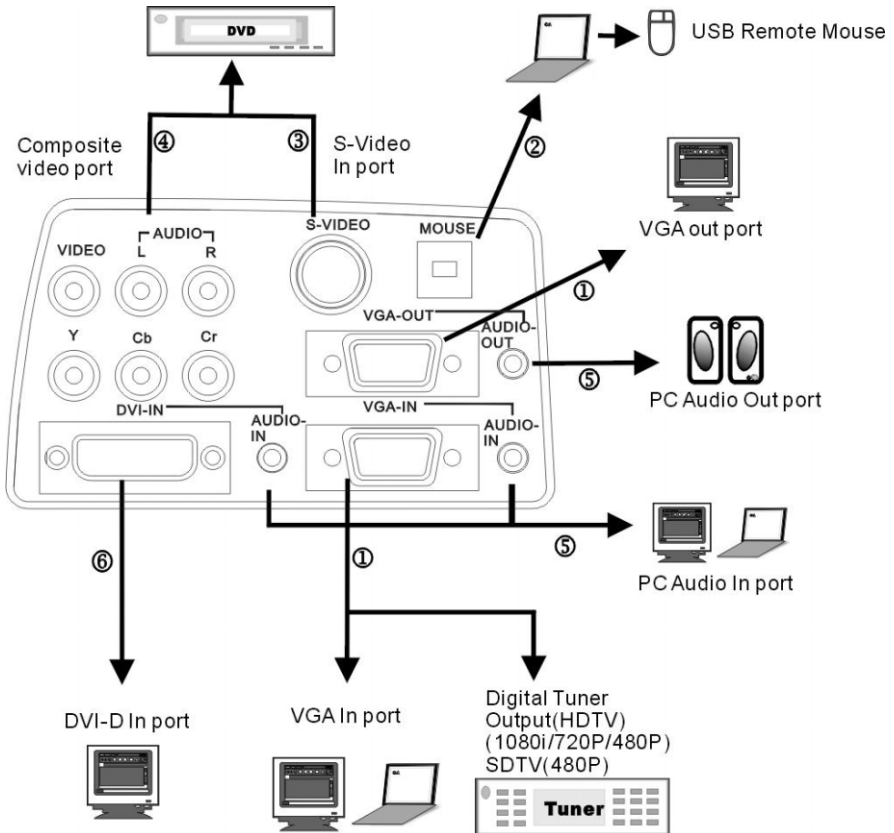

1. VGA In/Out port
2. USB In port
3. S-Video In port
4. Composite Video port
5. PC Audio In/Out In port
6. DVI-D In port

6.2 How to connect the projector to your computer

- 1) Plug the VGA cable into the VGA port at the left side of projector, then plug the other end of VGA cable into the computer.

Note: If you are connecting to a notebook, you may need to make adjustments to the notebook's display settings first. Please refer to the user's guide that came with your notebook.

- 2) If you want to use the remote control as a mouse, plug the USB cable into the USB port at the left side of projector, and then plug the other end into the computer.
- 3) If your presentation contains an audio track, plug the PC Audio in/out cable into the Audio In port at the left side of projector then plug the other end into the computer.
- 4) Turn on the projector first, then the computer.

6.3 How to connect the projector to a DVD player or VCR

If you are using composite video cable, please refer to the following description to complete the connection action.

- 1) Plug the yellow, red, and white composite cable connectors separately into the same color port at the left side of projector.
- 2) Then plug the yellow, red, and white connectors on the other end into the corresponding ports on the back of the DVD player or VCR.

If you are using S-video cable, please refer to the following description to complete the connection action.

- 1) Plug the S-Video cable connector into the S-Video port at the left side of projector, then plug the other end into the DVD player or VCR.
- 2) Plug the red and white connectors from a composite video cable into the corresponding ports at the left side of projector, then plug the other end of red and white connectors into the corresponding ports on the back of DVD player or VCR.

Note: When you are using the S-Video cable along with the A/V cable, make sure you do not plug in the A/V cable's yellow connector.

After you have connected all components to the projector, you are ready to begin using the projector.

6.4 Turning on the projector:

- 1) Remove the lens cap.
- 2) Ensure the cable connectors have connected properly.
- 3) Plug the power cord, press the main switch on the top of power cord socket of the projector, Power LED blinks steadily and slowly.
- 4) Press down the “Power” button on the remote control or panel to turn on the projector, the Power LED displays steady green.
- 5) The projection screen displays “Warming up! Please wait! ”. Please wait for 30sec; the projector will automatically detect the input source.
- 6) If the screen displays “No signal”, ensure the source is turned on and the cables are properly connected.
- 7) To have the best image performance, press “AUTO/ENTER” each time when you turn on the projector.

Note: After the projector is turned on, it will detect the interior temperature automatically. If it is overheated, Lamp LED will blink rapidly and the fan will carry out cooling action automatically after rotating 8 sec. At this time, “Power” will have no function.

6.5 Basic image adjustment

- 1) Power up your equipment in right order and aim the projector at the screen.
- 2) Please rotate the zoom ring to adjust the image size.
- 3) Please rotate the focus ring to adjust the image focus.
- 4) Please use the tilt foot to adjust the image height.
- 5) Please use the panel or remote control to adjust the horizontal and vertical position of image or execute keystone correction.
- 6) Please use the OSD menu to adjust the brightness, contrast and color of the screen.

6.6 Turning off the projector

- 1) Press “Power” button to turn off the projector lamp.
- 2) When you press the “Power ” button, you will see the message stating “Press Power again to turn off the lamp!”. At this time, you only have to press “Power” button again to turn off the projector. Or else the message will disappear automatically after 5 sec.
- 3) After the lamp is turned off, LED indicator will blink rapidly. At this time, “Power” will have no function. To restart the projector, please wait 60 sec, when LED indicator blinks slowly and steadily, you can restart the projector.
- 4) After turning off the main switch on the top of power cord socket of the projector, then disconnect the power cable.

Note: To extend the lamp life-span, please do not unplug the power cord immediately after the lamp is turned off. Please allow at least 120 sec for the fan to stop, and then you can unplug the power cord.

6.7 Adjusting the projected image height.

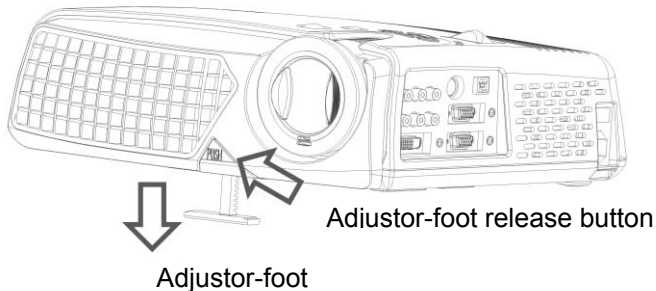

To adjust the tilt angle of the projector

To raise the projector

1. Press and hold the Adjustor-foot release button.
2. Raise the projector to the height you want, then release the button to lock the foot into position.

To lower the projector

1. Press and hold the Adjustor-foot release button.
2. Lower the projector to the height you want, then release the button to lock the foot into position.

6.8 Adjusting the image focus and zoom

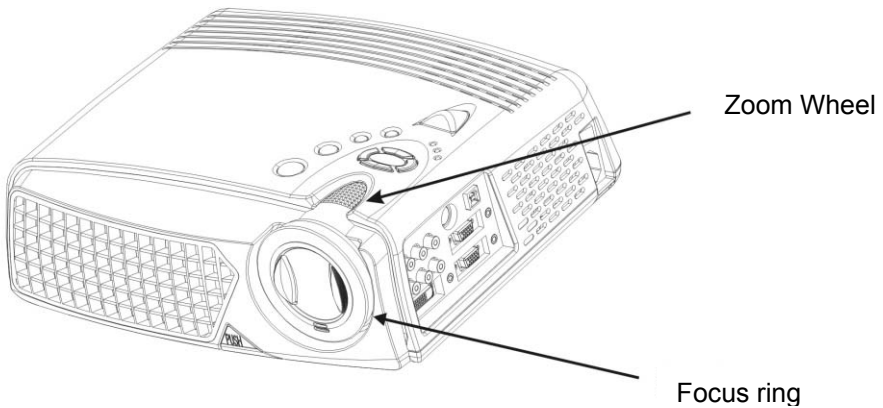

You can adjust the zoom ring to magnify or minify the image. Rotate counterclockwise to magnify the image. Rotate clockwise to minify the image. To adjust the focus, please rotate the focus ring to obtain the best focus. The focus distance of this projector is 1.4~12 meter.

7.OSD Menu

Press “Menu” button to open the menu. Press up and down button to choose the OSD options or press Esc to exit. To enter the submenu, please press “Auto/Enter” button or right button. Under the submenu, press “Menu” or the Esc button on the remote control to return to Menu main screen or double click to exit the OSD menu.

7.1 Image (Computer mode)

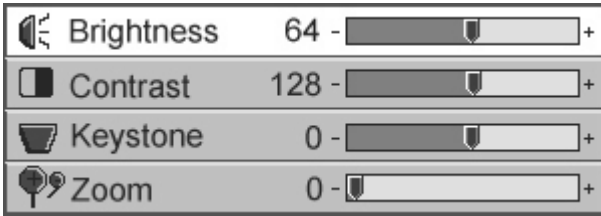

Submenu options	Description	Operation method
Brightness (**)	Adjusts the brightness of the display image	<ul style="list-style-type: none"> • Press←button can reduce the brightness of display image. • Press→button can increase the brightness of display image.(*)
Contrast	Adjusts the contrast of the display image.	<ul style="list-style-type: none"> • Press←button can reduce the contrast of display image. • Press→button to increase the contrast of display image.(*)
Keystone	Corrects a display image that is wider at the top or at the bottom.	<ul style="list-style-type: none"> • Press←button to correct the display image that is wider at the bottom. • Press→ button to correct the display image that is wider at the top.(*)
Zoom	Enlarges or reduces the display image.	<ul style="list-style-type: none"> • Press←button to reduce the display image. • Press→button to enlarge the display image.(*) • Please press Auto/Enter button to enter zoom operation. <ul style="list-style-type: none"> ➤ Under this mode, press←→buttons to shift the image, press the Pg Up and Pg Dn button on the remote control to adjust the image size.

* Press “Auto” button to return to previous setting value.

**If the source is switched to HDTV/DVD 480P, the “Brightness” turns to “Tint” the adjust the balance between red and blue colors in the image.

7.2 Image (Video mode)

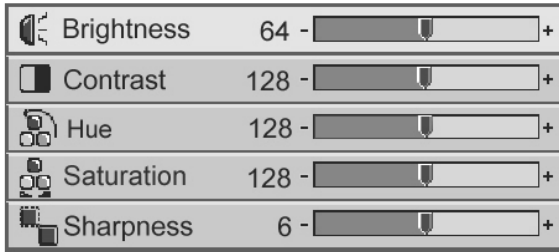

Submenu options	Description	Operation method
Brightness	Adjusts the brightness of the display image.	<ul style="list-style-type: none"> • Press←button can reduce the brightness of display image. • Press→button can increase the brightness of display image.(*)
Contrast	Adjusts the contrast of the display image.	<ul style="list-style-type: none"> • Press←button can reduce the contrast of display image. • Press→button to increase the contrast of display image.(*)
Hue	Adjusts the balance between red and green color levels.	<ul style="list-style-type: none"> • Press←button to increase the color level of green. • Press→button to increase the color level of red.(*)
Saturation	Changes the display image from black and white to color.	<ul style="list-style-type: none"> • Press←button to reduce the color saturation. • Press→button to increase the color saturation level.(*)
Sharpness	Adjusts the sharpness of the display image..	<ul style="list-style-type: none"> • Press←button to reduce the sharpness. • Press→button to increase the sharpness.(*)

* Press “Auto” button to return to previous setting value.

7.3 Display (Computer mode)

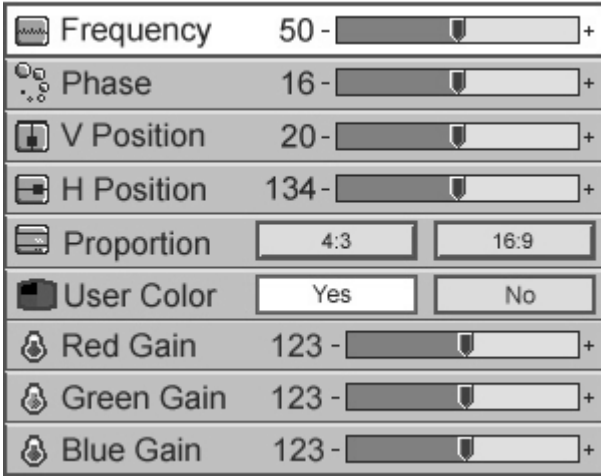

Submenu options	Description	Operation method
Frequency	Minimizes any vertical bars or stripes visible on the screen background.	<ul style="list-style-type: none"> • Press ← → button to adjust (*).
Phase	Removes any horizontal distortion and clears or sharpens the displayed characters.	<ul style="list-style-type: none"> • Press ← → button to adjust(*).
V position	Adjusts the display image up and down.	<ul style="list-style-type: none"> • Press ← button to move down the display image. • Press → button to move up the display image.(*)
H position	Adjusts the display image left and right.	<ul style="list-style-type: none"> • Press ← button to move the display image to the left. • Press → button to move the display image to the right.(*)

Proportion	Switches between a display image mode of 4:3 or 16:9.	<ul style="list-style-type: none"> • Press ← → button to choose.
User color	Activates individual red, green, or blue color correction controls.	<ul style="list-style-type: none"> • Choose Yes, and the red gain, green gain, green gain option emerges. • Choose No, and only color temperature appears.
Red Gain	Customizes the red color levels.	<ul style="list-style-type: none"> • Press←button to reduce the red color levels of the image. • Press→button to increase the red color levels of the image.(*)
Green Gain	Customizes the green color levels.	<ul style="list-style-type: none"> • Press←button to reduce the green color levels of the image. • Press→button to increase the green color levels of the image.(*)
Blue Gain	Customizes the blue color levels.	<ul style="list-style-type: none"> • Press←button to reduce the blue color levels of the image. • Press→button to increase the blue color levels of the image.(*)
Color temperature	Increases the red or blue tint of the display image.	<ul style="list-style-type: none"> • Press←button to reduce the color temperature, and the screen will display the warmer feeling. • Press→button to increase the color temperature, and the screen will display the colder feeling.(*)

* Press “Auto” button to return to previous setting.

7.4 Display (Video mode)



Submenu options	Description	Operation method
Keystone	Corrects a display image that is wider at the top or at the bottom.	<ul style="list-style-type: none"> • Press ← button to correct the display image that is wider at the bottom. • Press → button to correct the display image that is wider at the top.(*)
Proportion	To choose the screen image proportion 16:9 or 4:3.	<ul style="list-style-type: none"> • Press ← → button to choose.

* Press “Auto” button to return to previous setting.

7.5 Audio



Submenu options	Description or operation method
Volume	<ul style="list-style-type: none"> • Press←button to decrease the volume. • Press→button to increase the volume.(*)
Balance	<ul style="list-style-type: none"> • Press←button to decrease the volume of the left speaker. • Press→button to increase the volume of the right speaker.(*)
Treble	<ul style="list-style-type: none"> • Press←button to decrease the treble • Press→button to increase the treble.(*)
Bass	To adjust the low frequency of the sound source. <ul style="list-style-type: none"> • Press←button to weaken the bass. • Press→button to enhance the bass.(*)
Mute	<ul style="list-style-type: none"> • Choose “Yes” to mute.

* Press “Auto” button to return to previous setting.

7.6 Management

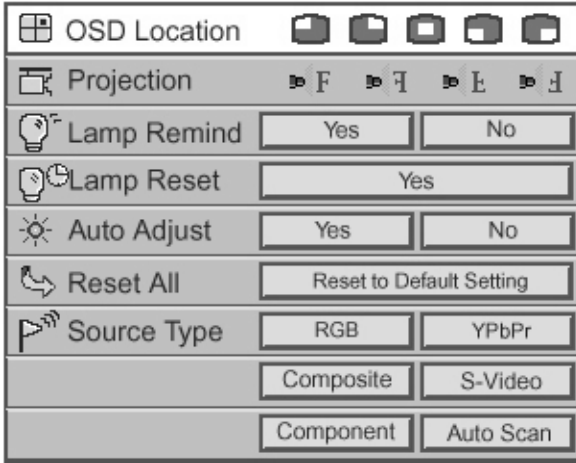

Submenu options	Description	Operation method
OSD location	Adjusts the position of the OSD within the display image.	<ul style="list-style-type: none"> Press ← → button to select (*).
Projection	<p>▸ F (Projection before the screen) Default</p> <p>▸ I (Projection behind the screen) Flips the display image so it can be viewed correctly when the projector is set up for rear screen projection.</p> <p>▸ E ▸ J (Projection ceiling-mounted) Flips the display image so it can be viewed correctly when the projector is ceiling-mounted.</p>	<ul style="list-style-type: none"> Press ← → button to select (*).
Lamp remind	Displays the hours that the lamp has been in use and lets you set a warning message that will be displayed when the lamp is within 30 hours of maximum lamp life.	<ul style="list-style-type: none"> Press ← → button to select.

Lamp Reset	Resets the lamp timer after replacing the lamp module.	<ul style="list-style-type: none"> Press right button, then it will display the message stating “Press Auto/Enter button, reset the lamp timer” to confirm that the user has replaced the lamp. After replacing the lamp, please press “Auto/Enter” button. Or otherwise, press “Menu” button or the “Esc” on remote control.
Auto Adjust	Automatically adjusts the display image to the ideal settings for the display source.	<ul style="list-style-type: none"> Select Yes, and the brightness and contrast value will be adjusted automatically each time you press “Auto” button. Select No, the brightness and contrast value is fixed and unchanged.
Reset All	Returns all settings to the factory defaults.	<ul style="list-style-type: none"> Press right button.
Source type	Switches between available vide input sources.	<ul style="list-style-type: none"> Press ← → button to choose.

* Press “Auto” button to return to previous setting.

7.7 Language

Changes the language of the OSD menu. Choose between English, German, French, Italian, Spanish, Portuguese, Japanese, Traditional, Chinese, and Simple Chinese.

English	English
German	Deutsch
French	Français
Italian	Italiano
Spanish	Español
Portuguese	Português
Japanese	日本語
Traditional Chinese	繁體中文
Simple Chinese	简体中文

8. Maintenance and service

Change the module lamp immediately when the lamp life reaches 1500 hrs to maintain the best projection image.

8.1 Replacing the lamp module

When the lamp is within 30 hours of maximum lamp life, projector will display a warning automatically stating, “Lamp has reached its end of life! Lamp replacement is suggested!”. When this message appears, please change the lamp immediately.

To replace the lamp module:

1. Turn off the projector and wait for the fan to stop.
2. Turn off the main power switch, and disconnect the power cord and all cables.
3. Let the projector lamp cool down completely (approximately 30 minutes).
4. Use screwdriver to loosen the screws of lamp access panel and lamp module.
5. Take out the lamp module.
6. Gently process the new lamp module into the lamp bay, then replaces the lamp module retaining screws.
7. Replace the lamp bay access panel, and then replace the access panel screw.

Use screwdriver to loosen the lamp access panel screws, and then press down the access panel lock to remove the access panel.



Remove the three lamp module retaining screws, unsnap the lamp removal handle to change the lamp module.



8.2 Cleaning the projector lens

Please follow the following procedures to clean the projector lens:

- 1 Pour out a little cleaner on a clean soft cloth. Do not use the cleaner with particle, the cleaner that contains solvent or other chemicals of poor quality, they may cause damage to the projector lens.
- 2 Use the soft cloth to wipe the projector lens lightly according to the direction of a certain circling motion.
- 3 After finish wiping, place the lens cap on when the projector is not being used.

9. Appendix

9.1 Common problems and solutions

When you encounter problems while using the projector, please refer to the following contents:

If the suggestions in the troubleshooting section does not correct the problem, please contact the local distributor or our customer service center.

■No picture on the screen

- ⇒Make sure that all components are connected correctly and securely in accordance to the connection method and line that is introduced in the previous chapter.
- ⇒Make sure the power cord is not bended or broken.
- ⇒Make sure that the main switch of projector is turned on.
- ⇒Check whether the lamp of projector is securely installed.
- ⇒Make sure you have removed the lens cap and turn on the projector switch.

■The screen resolution is not right

- ⇒ Make sure the computer's video card is set for a resolution of no greater than 1280 X 1024.

■Display image is instable or flashing

- ⇒Please press the “Auto” button on the remote control or the Auto/Enter button on the projector.
- ⇒Or use “Phase” option in the “Display” menu to correct.
- ⇒Or change the color setting of display from your computer.

■Display image has vertical flashing stripes or bars.

- ⇒Please press the “Auto” button on the remote control or the Auto/Enter button on the projector.
- ⇒ Or use “Frequency” option in the “Display” menu to adjust.
- ⇒Or check and resetting the display mode of your display card and make it be compatible with this product.

■The focus of display image is blurred

⇒Adjust the focus ring on the projector.

⇒Make sure the projection screen is 1.4 ~12 meters from the projector.

■Projected colors don't match the computer or video player's colors

⇒This is a normal phenomenon; just adjust the brightness, color or contrast value in the menu.

■When projector is connected to DVD, and the film aspect ratio is 16:9, the display image is distorted.

⇒Please adjust the image proportion of projector into 4:3.

■Image is reversed

⇒Open the Menu, and then choose "Projection setting" option to adjust the projection method.

■Lamp is burned or cracking sound happens.

⇒When the lamp has reached its end of life, it will burn out and may produce shatter of glass. Sometimes, it will jam the fan and causing it unable to start. If this kind of condition is happening, please contact the local authorized distributor to buy the lamp module for replacement.
If you want to change the lamp, please refer to the procedures of "Changing the lamp module" and act accordingly.

**9.2 The distance proportion between screen and projector
(Based on Zoom Ratio 1.18:1, for reference only)**

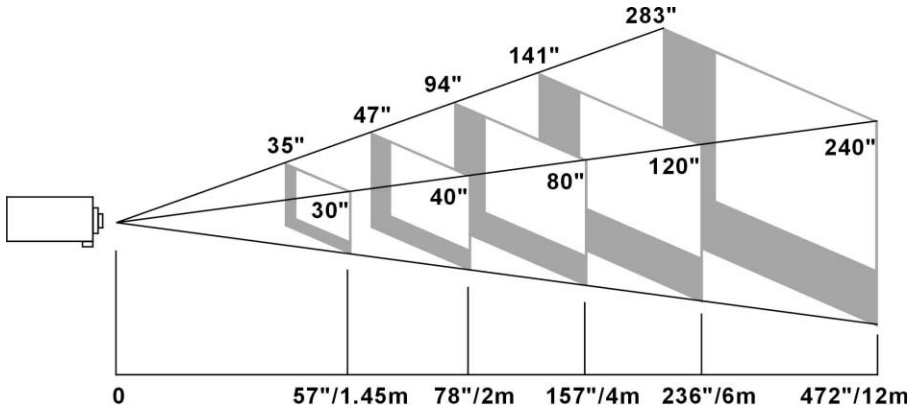

Projection distance	1.45M	2M	4M	6M	12M
Tele Projection screen size	30"	40"	80"	120"	240"
Wide Projection screen size	35"	47"	94"	141"	283"

9.3 Specifications

Model No.	EIP-25
Resolution	XGA(1024*768), SXGA(1280*1024) compressed
Lamp	250W User Replaceable VIP Lamp
Brightness	2500 Lumens
Dimensions	330 x 276 x 104 mm
Weight	7.5 lbs
Projection distance	1.4m--12m
Ratio of projection screen and distance	1.34:1-- 1.6:1 (Distance: Diagonal)
Zoom ratio	1.2:1 (Manual Zoom/Focus)
Uniformity	80%
Screen proportion	4:3 / 16:9 screen selectable
Contrast ratio	1800 : 1
H. Frequency	31.5 -- 80 kHz
V. Scan rate	56 -- 85 Hz
Video compatibility	NTSC / PAL /SECAM
HDTV compatibility	480p/720p/1080i
Power supply	90 to 240 VAC, 50 to 60 Hz
Power consumption	350W
IO port	DVI, USB Mouse, RGB In(D-Sub 15 pin), RGB Out(D-Sub 15 pin), Component Video, S-Video Mini DIN 4 pin, Audio: RCA Jack, 3.5mm Mini Jack, Composite Video(RCA Jack), PC Audio In, PC Audio Out, 2 watt speaker

* The specifications are subject to change without notice.

This device complies with Part 15 of the FCC Rules. Operation is subject to the following two conditions: (1) the device may not cause harmful interference, and (2) this device must accept any interference received, including interference that may cause undesired operation.



A-key to better communications

U.S.A.

EIKI International, Inc.
30251 Esperanza
Rancho Santa Margarita
CA 92688-2132

U.S.A.

Tel : 800-242-3454 (949)-457-0200
Fax : 800-457-3454 (949)-457-7878
E-Mail : usa@eiki.com

Deutschland & Österreich

EIKI Deutschland GmbH
Am Frauwald 12
65510 Idstein
Deutschland
Tel : 06126-9371-0
Fax : 06126-9371-14
E-Mail : info@eiki.de

Canada

EIKI CANADA - Eiki International, Inc.
P.O. Box 156, 310 First St. - Unit 2,
Midland, ON, L4R 4K8, Canada
Tel : 800-563-3454 (705)-527-4084
Fax : 800-567-4069 (705)-527-4087
E-Mail : canada@eiki.com

Eastern Europe

EIKI CZECH spol. s.r.o.
Umělecká 15
170 00 Praha 7
Czech Republic
Tel : +42 02 20570024
+42 02 20571413
Fax : +42 02 20571411
E-Mail : easterneurope@eiki.de

Japan & Worldwide

EIKI Industrial Company Limited.
4-12 Banzai-Cho, Kita-Ku, Osaka,
530-0028 Japan
Tel : +81-6-6311-9479
Fax : +81-6-6311-8486
E-Mail : WorldWide@eiki.com

WorldWide Website <http://www.eiki.com>

7538500014-0A

Free Manuals Download Website

<http://myh66.com>

<http://usermanuals.us>

<http://www.somanuals.com>

<http://www.4manuals.cc>

<http://www.manual-lib.com>

<http://www.404manual.com>

<http://www.luxmanual.com>

<http://aubethermostatmanual.com>

Golf course search by state

<http://golfingnear.com>

Email search by domain

<http://emailbydomain.com>

Auto manuals search

<http://auto.somanuals.com>

TV manuals search

<http://tv.somanuals.com>