

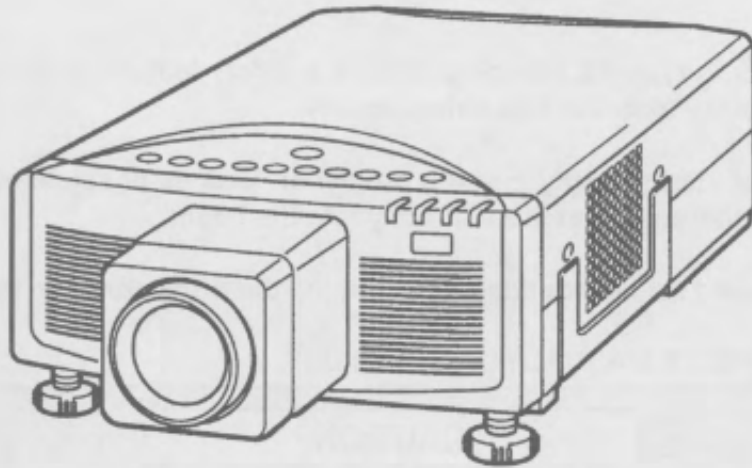

MULTIMEDIA PROJECTOR

MODEL LC-7000U



OWNER'S INSTRUCTION MANUAL

INFORMATION TO THE USER

NOTE: This equipment has been tested and found to comply with the limits for a Class A digital device, pursuant to Part 15 of the FCC Rules. These limits are designed to provide reasonable protection against harmful interference when the equipment is operated in a commercial environment. This equipment generates, uses, and can radiate radio frequency energy and, if not installed and used in accordance with the instruction manual, may cause harmful interference to radio communications. Operation of this equipment in a residential area is likely to cause harmful interference in which case the user will be required to correct the interference at his own expense.

SAFETY PRECAUTIONS

WARNING:

TO REDUCE THE RISK OF FIRE OR ELECTRIC SHOCK, DO NOT EXPOSE THIS APPLIANCE TO RAIN OR MOISTURE.

The projector has a grounding-type AC line plug. This is a safety feature to be sure that the plug will fit into the power outlet. Do not try to defeat this safety feature.

Intense light source. Do not stare directly into the projection lens as possible eye damage could result. Be especially careful that children do not stare directly into the beam.

If the projector will not be used for an extended time, unplug the projector from the power outlet.

READ AND KEEP THIS OWNER'S MANUAL FOR LATER USE.

	CAUTION RISK OF ELECTRIC SHOCK DO NOT OPEN	
CAUTION: TO REDUCE THE RISK OF ELECTRIC SHOCK, DO NOT REMOVE COVER (OR BACK). NO USER-SERVICEABLE PARTS INSIDE. REFER SERVICING TO QUALIFIED SERVICE PERSONNEL.		
 THIS SYMBOL INDICATES THAT DANGEROUS VOLTAGE CONSTITUTING A RISK OF ELECTRIC SHOCK IS PRESENT WITHIN THIS UNIT.	 THIS SYMBOL INDICATES THAT THERE ARE IMPORTANT OPERATING AND MAINTENANCE INSTRUCTIONS IN THE OWNER'S MANUAL WITH THIS UNIT.	

IMPORTANT:

For your protection in the event of theft or loss of this LC Data-Grade projector, please record the Model Number and Serial Number located on the rear of unit and retain this information. Refer to these numbers whenever you call upon your authorized dealer regarding this product.

Do not discard shipping carton and packing materials. These items may be needed for storage or future servicing.

Model No: LC-7000U

Serial No: _____

IMPORTANT SAFETY INSTRUCTIONS

All the safety and operating instructions should be read before the product is operated.

Read all of the instructions given here and retain them for later use. Unplug this projector from AC power supply before cleaning. Do not use liquid or aerosol cleaners. Use a damp cloth for cleaning.

Do not use attachments not recommended by the manufacturer as they may cause hazards.

Do not place this projector on an unstable cart, stand, or table. The projector may fall, causing serious injury to a child or adult, and serious damage to the projector. Use only with a cart or stand recommended by the manufacturer, or sold with the projector. Wall or shelf mounting should follow the manufacturer's instructions, and should use a mounting kit approved by the manufacturer.

Do not expose this unit to rain or use near water... for example, in a wet basement, near a swimming pool or the like.

Slots and openings in the cabinet and the back or bottom are provided for ventilation, to insure reliable operation of the equipment and to protect it from overheating.

The openings should never be covered with cloth or other material, and the bottom opening should not be blocked by placing the projector on a bed, sofa, rug, or other similar surface. This projector should never be placed near or over a radiator or heat register.

This projector should not be placed in a built-in installation such as a bookcase unless proper ventilation is provided.

This projector should be operated only from the type of power source indicated on the marking label. If you are not sure of the type of power supplied, consult your authorized dealer or local power company.

Do not overload wall outlets and extension cords as this can result in fire or electric shock. Do not allow anything to rest on the power cord. Do not locate this projector where the cord will be abused by persons walking on it.

Never push objects of any kind into this projector through cabinet slots as they may touch dangerous voltage points or short out parts that could result in a fire or electric shock. Never spill liquid of any kind on the projector.

Do not attempt to service this projector yourself as opening or removing covers may expose you to dangerous voltage or other hazards. Refer all servicing to qualified service personnel.

Unplug this projector from wall outlet and refer servicing to qualified service personnel under the following conditions:

- a. When the power cord or plug is damaged or frayed.
- b. If liquid has been spilled into the projector.
- c. If the projector has been exposed to rain or water.
- d. If the projector does not operate normally by following the operating instructions. Adjust only those controls that are covered by the operating instructions as improper adjustment of other controls may result in damage and will often require extensive work by a qualified technician to restore the projector to normal operation.
- e. If the projector has been dropped or the cabinet has been damaged.
- f. When the projector exhibits a distinct change in performance-this indicates a need for service.

When replacement parts are required, be sure the service technician has used replacement parts specified by the manufacturer that have the same characteristics as the original part. Unauthorized substitutions may result in fire, electric shock, or injury to persons.

Upon completion of any service or repairs to this projector, ask the service technician to perform routine safety checks to determine that the projector is in safe operating condition.



This projector is equipped with a grounding type AC line plug. Should you be unable to insert the plug into the outlet, contact your electrician. Do not defeat the safety purpose of this grounding type plug.

Follow all warnings and instructions marked on the projectors.

For added protection for the projector during a lightning storm, or when it is left unattended and unused for long periods of time, unplug it from the wall outlet. This will prevent damage due to lightning and powerline surges.



An appliance and cart combination should be moved with care. Quick stops, excessive force, and uneven surfaces may cause the appliance and cart combination to overturn.

TABLE OF CONTENTS

	PAGE
INTRODUCTION	5
POWER REQUIREMENT	6
DESCRIPTION	7
SETTING-UP THE PROJECTOR	8-9
MOVING THE PROJECTOR	9
CONNECTING THE PROJECTOR	10-17
OPERATION OF CONTROLS	18-19
OPERATION OF REMOTE CONTROL	20-21
CONTROL THE PROJECTOR	22-23
USING THE PROJECTOR	24-25
COMPUTER SYSTEM SELECT (COMPUTER MODE)	26-27
PICTURE IMAGE ADJUSTMENT (COMPUTER MODE)	28-29
PICTURE SCREEN ADJUSTMENT (COMPUTER MODE)	30
COLOR SYSTEM SELECT (VIDEO MODE)	31
PICTURE IMAGE ADJUSTMENT (VIDEO MODE)	32-33
PICTURE SCREEN ADJUSTMENT (VIDEO MODE)	34
OTHER FUNCTION SETTING	35-36
PC ADJUSTMENT	37-38
LANGUAGE ADJUSTMENT	39
AIR FILTER CARE AND CLEANING	40
TEMPERATURE WARNING INDICATOR	40
LAMP REPLACEMENT	41
CLEANING THE LENS	42
TROUBLESHOOTING	42-43
TECHNICAL SPECIFICATIONS	44

INTRODUCTION

The projector is a multimedia projector designed for portability, durability, and ease of use. The projector utilizes built-in multimedia features, a palette of 16.8 million colors, and active matrix liquid crystal display (LCD) technology.

COMPATIBILITY

The projector is compatible with many different types of personal computers and video devices, including;

- IBM-compatible computers, including laptops, up to 1024 × 768 resolution with a vertical frequency up to 75Hz.
- Apple Macintosh and PowerBook computers up to 1024 × 768 resolution.
- Various VCRs, video disc players, video cameras, satellite TV tuners or other AV equipment using any of the worldwide video standards, including NTSC, NTSC4.43, PAL and SECAM.

IMAGE RESOLUTION

The resolution of the projector's projected image is 832 × 624. The projector displays computer images just as they appear on your computer's monitor. Screen resolutions between 832 × 624 and 1024 × 768 are compressed to 800 × 600. The projector cannot display screen resolutions above 1024 × 768. If your computer's screen resolution is higher than 1024 × 768, reset it to a lower resolution before you connect the projector.

PORTABILITY

The projector is extremely compact in size and weight. Having a sophisticated shape like an attaché case with a retractable carrying handle, the projector will help you make the powerful presentation wherever you go. To strengthen the portability, the LENS RETRACT function is designed to protect the lens from being damaged during transportation. With this function, the lens is pulled in when not in use.

UNPACKING THE PROJECTOR

The projector comes with the parts shown listed below. Check to make sure all are included. If any parts are missing, contact an authorized dealer or service station.

- Owner's Manual.
- AC Power Cord.
- Remote Control Transmitter Unit and batteries.
- Lens Cover.
- Protective Dust Cover.
- VGA Cable.
- VGA/MAC Adapter.
- Mouse Cable for PS/2 port.
- Mouse Cable for serial port.
- Mouse Cable for ADB port.

TRADEMARKS

- Apple, Macintosh, and PowerBook are trademarks or registered trademarks of Apple Computer, Inc.
- IBM and PS/2 are trademarks or registered trademarks of International Business Machines, Inc.

POWER REQUIREMENTS

Your projector uses nominal input voltages of 100-120 VAC. The projector automatically selects the correct input voltage. The projector is designed to work with single-phase power systems having a grounded neutral conductor. To reduce the risk of electrical shock, do not plug into any other type of power system. Consult your authorized dealer or service station if you are not sure what type of power is supplied to your building.

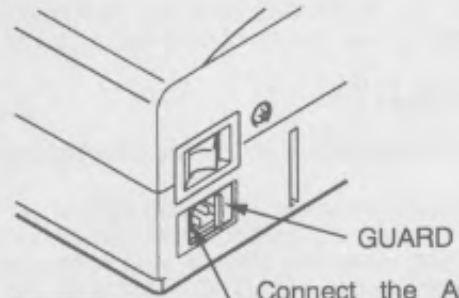

Slide the guard when the AC cord may not be connected by the guard.

Projector side (Female)

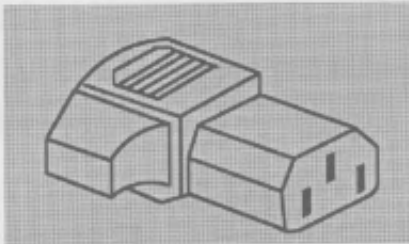

AC outlet side (Male)

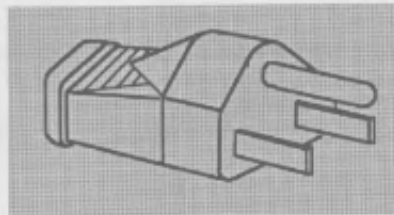

DESCRIPTION

FRONT

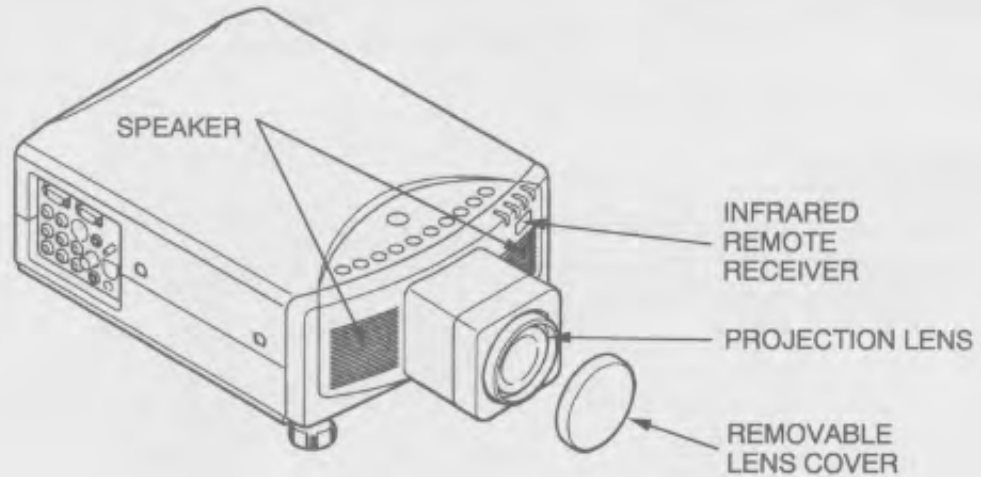

REAR

EXHAUST VENT



CAUTION HOT AIR !

Air blow from the exhaust vent is hot. Observe the following when handling your projector or choosing a location to install it.

- Keep heat-sensitive objects away from the exhaust port.
- If you set the projector on top of a metallic surface, the surface will become hot because of the hot air exhaust. Be careful when handling.
- Do not touch the cabinet near to the exhaust vent, and especially screws and metallic parts. These parts will become hot while the projector is used.

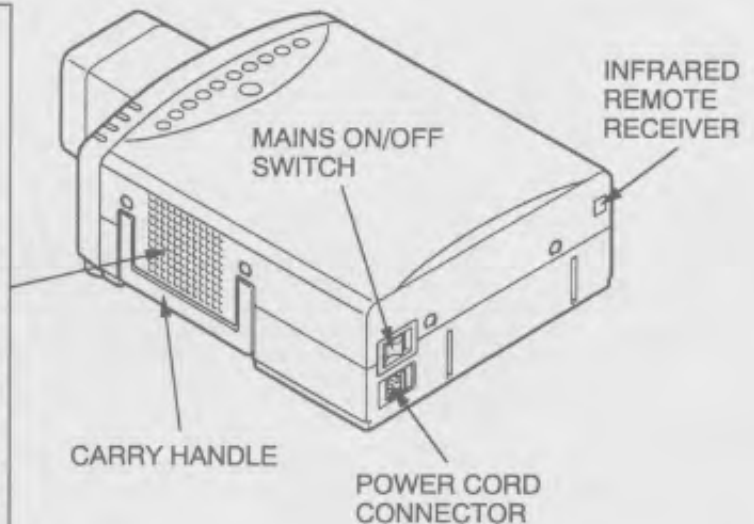

BOTTOM

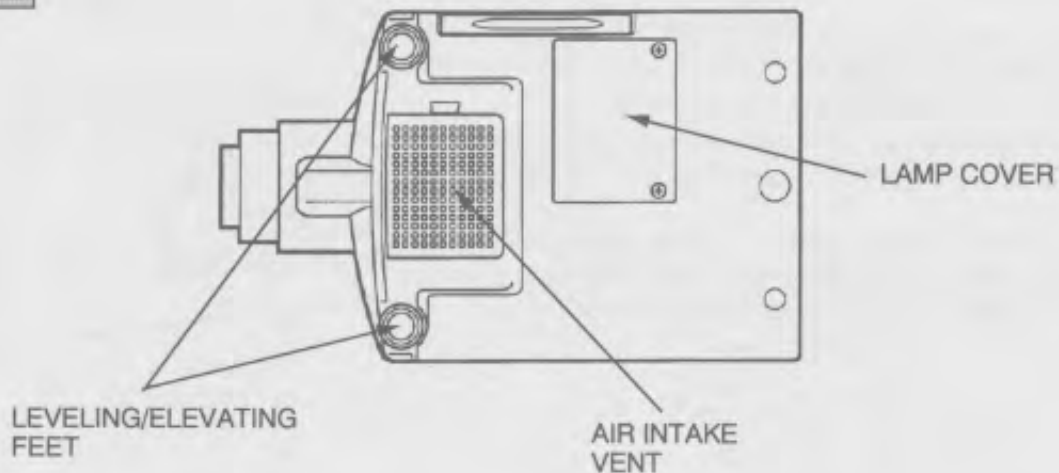

SETTING-UP THE PROJECTOR

POSITIONING:

- This projector is basically designed to project on a flat projection surface.
- This projector can be focused from 3.6' (1.1m) - 75.6' (23.0m).
- Use the illustration below as an example when positioning the projector to the screen.

ROOM LIGHT

The projector ideally should be placed in a room with very limited light. Picture quality will be directly affected by lighting conditions.

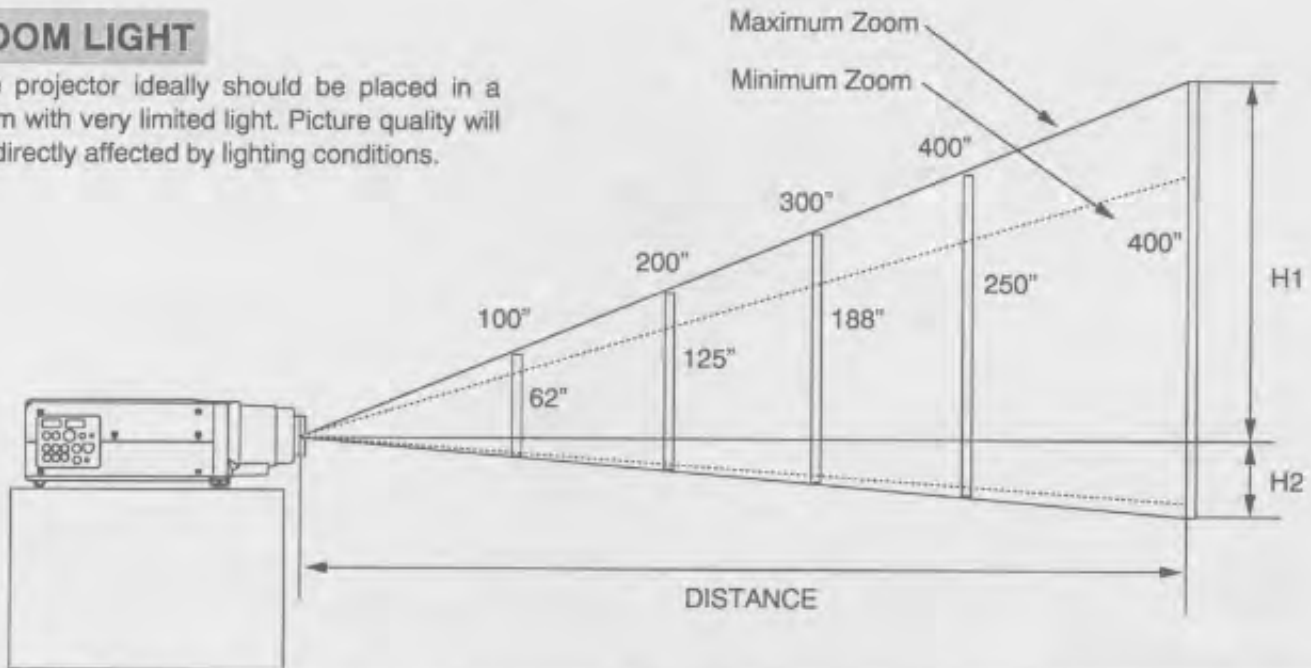

Screen Size	Max. Zoom	32"	60"	100"	150"	200"	300"	400"	640"
	Min. Zoom	20"	37"	62"	94"	125"	188"	250"	400"
Distance		3.6'(1.1 m)	6.9'(2.1 m)	11.8'(3.6 m)	17.8'(5.4 m)	23.7'(7.2 m)	35.2'(10.7 m)	47'(14.3 m)	75.6'(23.0 m)

Screen Size (W × H) inch	20"	60"	100"	150"	200"	300"	400"
	16 × 12	49 × 36	80 × 60	120 × 90	160 × 120	240 × 180	320 × 240
Height (H1)	10.7 inch	32 inch	53 inch	80 inch	106 inch	160 inch	212 inch
Height (H2)	1.3 inch	4 inch	7 inch	10 inch	14 inch	20 inch	28 inch

VENTILATION

Although this projector has a cooling fan to protect it from overheating, please be careful to set the projector so that it can cool properly and you can avoid a risk of fire and malfunction.



- Do not cover the vents with papers or other materials.
- Keep the side grill at least 3.3' (1m) away from any object.
- Make sure that there are no objects under the projector. An object under the projector may prevent the projector from taking the cooling air through the bottom vent.

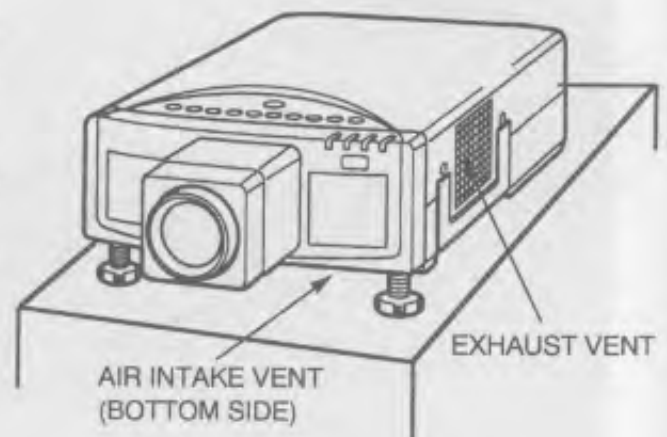

LEVELING AND ELEVATING ADJUSTMENTS

Picture adjustments can be made with the two leveling/elevating feet. Adjustments of 6° up are possible by rotating the feet on the bottom of the projector.

Adjust leveling of the projector, by rotating the two (left and right) feet on the bottom of the projector.

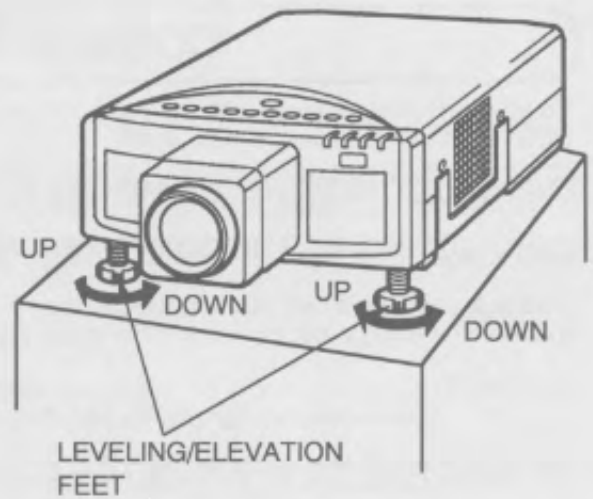

MOVING THE PROJECTOR

Use the carry handle when moving projector.
Replace the lens cover when moving the projector to prevent damage to the lens.

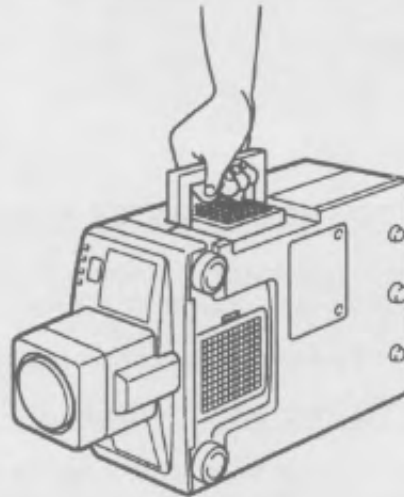

CONNECTING THE PROJECTOR

Your projector is equipped with various audio/video inputs and outputs including Computer HDB15-pin terminals, Monitor HDB15-pin terminals and S-VHS video .

CONNECTING THE COMPUTER

CONNECTING TO THE COMPUTER INPUT HDB15-PIN TERMINAL

Personal computers can be connected to the HDB15-pin terminal on the projector.

- Connect the computer to this terminal using the VGA cable and VGA/MAC adapter (provided).

WARNING: For projectors, VGA cable provided is designed to reduce RFI (Radio Frequency Interference) emissions. For regulatory compliance reasons, this cable must be used and must not be replaced by any other cable.

CONNECTING TO THE MONITOR OUTPUT HDB15-PIN TERMINAL

Monitor televisions can be connected to the HDB15-pin terminal on the projector.

- Connect the monitor television to this terminal using the monitor cable (not provided).

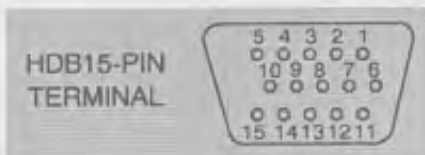

Pin No./Signal

- 1 Red input
- 2 Green input
- 3 Blue input
- 4 Sense 2
- 5 Ground (Horiz. sync.)
- 6 Ground (Red)
- 7 Ground (Green)
- 8 Ground (Blue)

Pin No./Signal

- 9 Non Connect
- 10 Ground (Vert. sync.)
- 11 Sense 0
- 12 Sense 1
- 13 Horiz. sync.
- 14 Vert. sync.
- 15 Reserved

CONNECTING TO THE COMPUTER AUDIO INPUT JACKS

- Connect audio outputs from your computer to these jacks using the audio cable (not provided).
- If the audio input of the audio equipment is stereo, be sure to connect the right and left channels to the respective right and left jacks.
- If the audio input of the audio equipment is monaural, connect it to the left jack.

CONNECTING TO THE MULTI-POLE 12-PIN (CONTROL PORT) CONNECTOR

- If you control the computer by projector's remote control unit, you must connect a cable (three type cables provided) from control port (PS/2, Serial or ADB port) on your computer to this connector.

■ CONTROL PORT

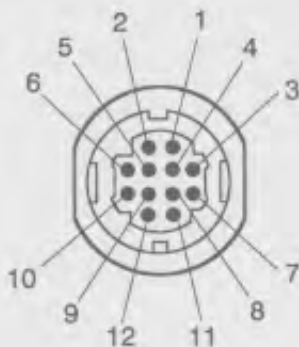

	PS/2 Port	Serial Port	ADB Port
1	_____	TxD	_____
2	CLK	_____	ADB
3	DATA	_____	_____
4	_____	_____	_____
5	_____	_____	_____
6	_____	_____	_____
7	_____	READY	_____
8	_____	_____	_____
9	GND	GND	GND
10	_____	_____	_____
11	_____	_____	_____
12	_____	_____	_____

Connecting an IBM-compatible desktop computer

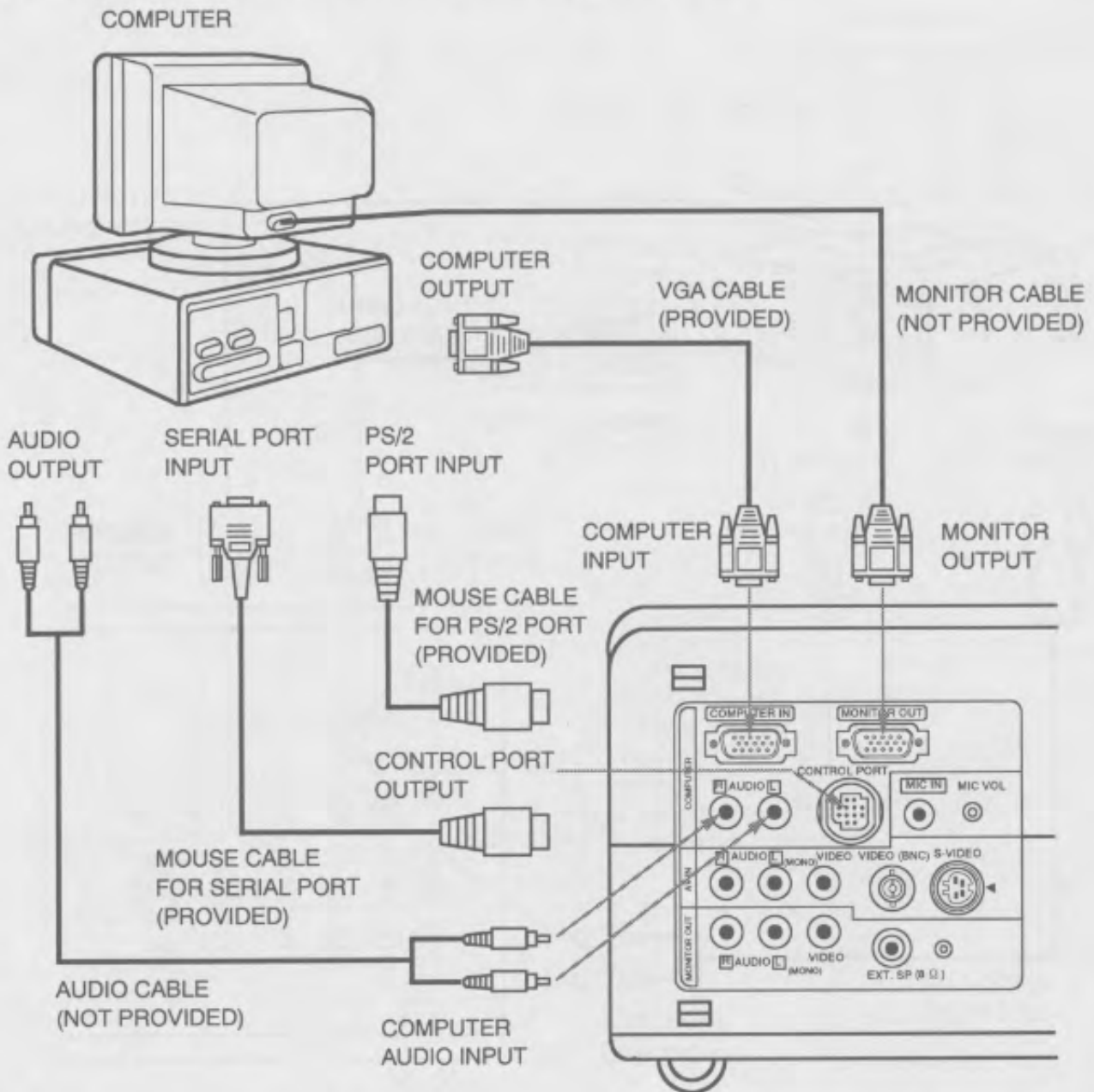

NOTE: The hook up should be done as per the above illustration. After hook up, turn on the projector, monitor, computer, in that order.

Connecting a Macintosh desktop computer

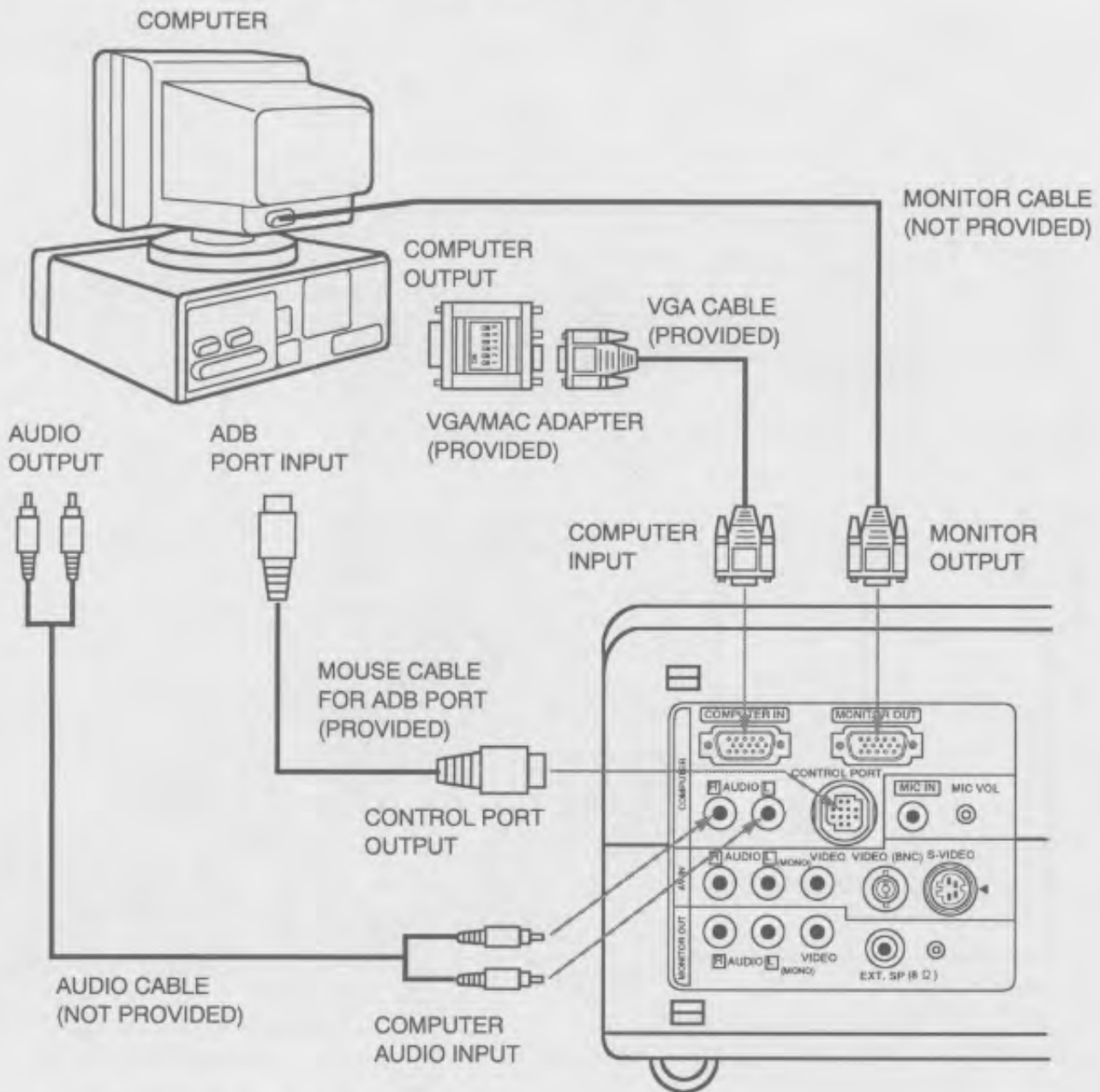

Set the slide switches as shown in the table below depending on the RESOLUTION MODE that you want to use before you turn on the projector and computer.

RESOLUTION MODE	SW1	SW2	SW3	SW4	SW5	SW6
13" MODE (640 × 480)	ON	OFF	OFF	OFF	OFF	OFF
16" MODE (832 × 624)	OFF	OFF	OFF	OFF	OFF	ON

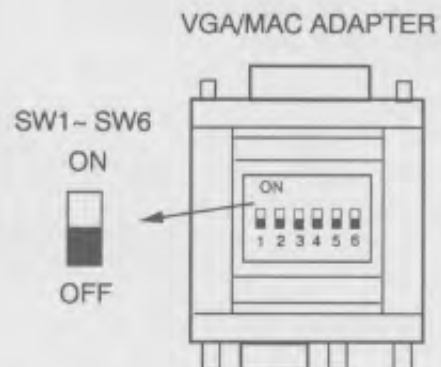

NOTE: The hook up should be done as per the above illustration. After hook up, turn on the projector, monitor, computer, in that order.

Connecting a IBM-compatible laptop computer

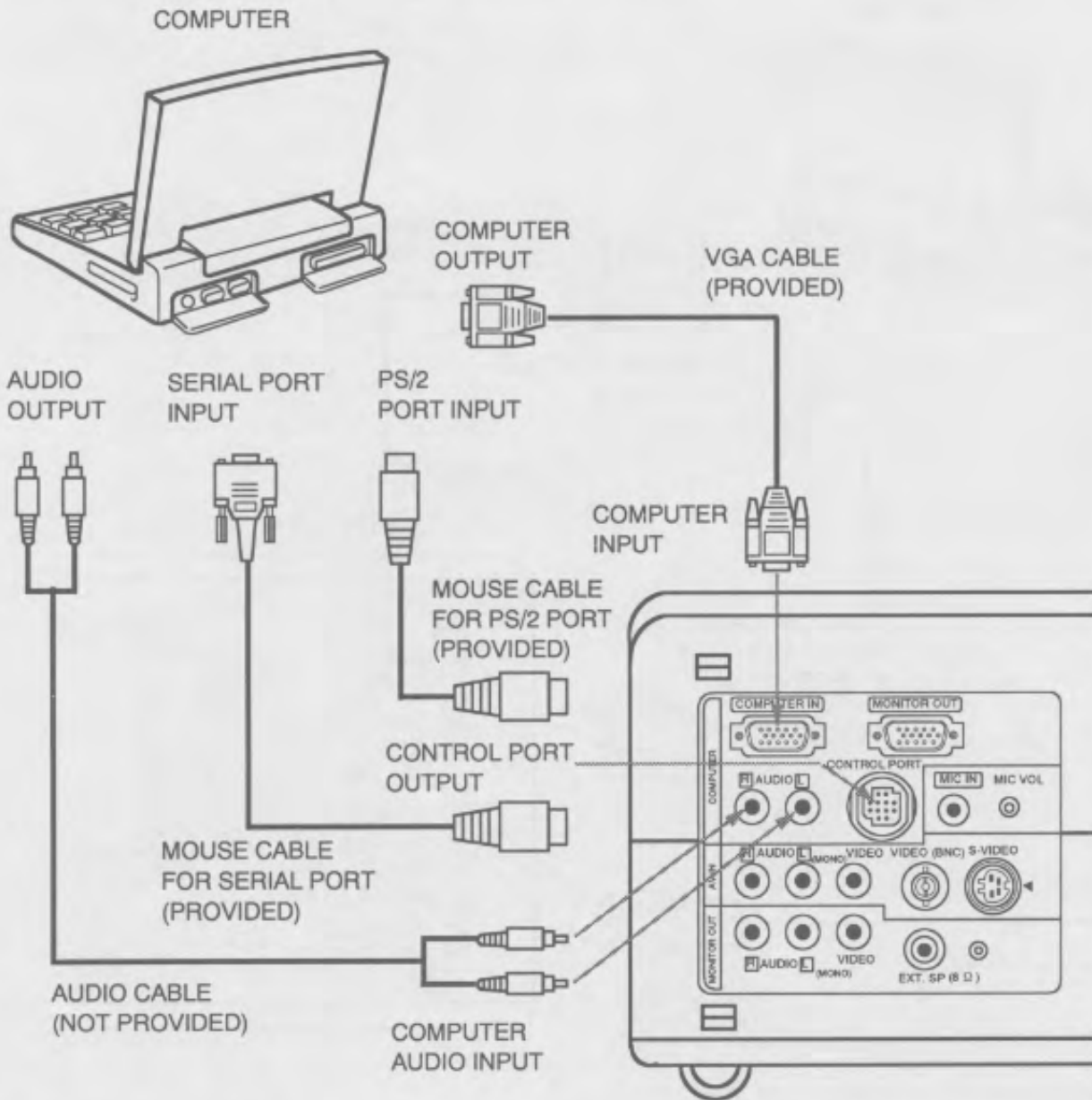

NOTE: The hook up should be done as per the above illustration. After hook up, turn on the projector, computer, in that order.

Connecting an Macintosh PowerBook computer

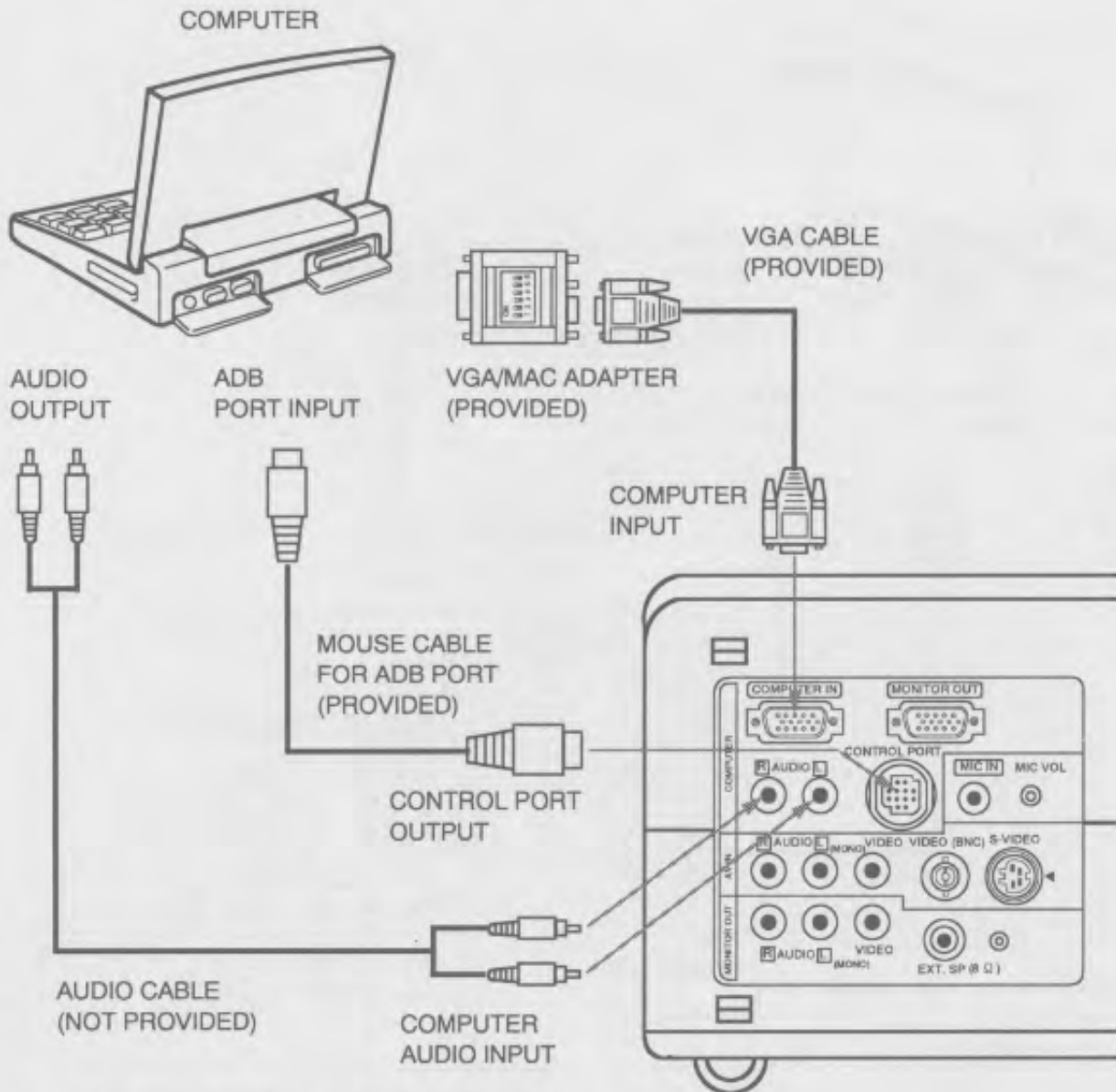

Set the slide switches as shown in the table below depending on the RESOLUTION MODE that you want to use before turn on the projector and computer.

RESOLUTION MODE	SW1	SW2	SW3	SW4	SW5	SW6
13" MODE (640 × 480)	ON	OFF	OFF	OFF	OFF	OFF
16" MODE (832 × 624)	OFF	OFF	OFF	OFF	OFF	ON

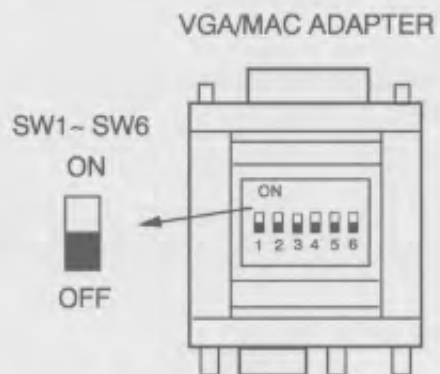

NOTE: The hook up should be done as per the above illustration. After hook up, turn on the projector, computer, in that order.

CONNECTING THE VIDEO EQUIPMENT

CONNECTING TO THE AV INPUT JACKS

Connect to the video and audio outputs of a VCR, video disc player, video camera, satellite TV tuner or other AV equipment.

- Connect audio/video outputs from external sources to these input jacks using the audio/video cable (not provided).
- If the audio signal from the AV equipment is stereo, be sure to connect the right and left channels to the respective right and left audio input jacks.
- If the external audio signal is monaural, connect it to the left jack.
- Do not connect the video sources to the video input jack (RCA TYPE) together with the BNC jack. Use one video input only for video input jack.

S-VHS FORMAT VCR CONNECTION

The AV input includes an extra video input jack marked S-VIDEO to allow connection to an S-VHS format VCR that has separate Y/C video signals. The S-VIDEO jack has priority over the VIDEO (RCA TYPE or BNC) jack.

CONNECTING TO THE MONITOR OUTPUT JACKS

These jacks contain the audio/video information that is viewed on the screen.

- Connect audio/video inputs from AV equipment to these output jacks using the audio/video cable (not provided).
- If the audio input of the audio equipment is stereo, be sure to connect the right and left channels to the respective right and left jacks.
- If the audio input of the audio equipment is monaural, connect it to the left jack.
- Whenever the S-VIDEO signal source is viewed on the screen, the video signal available at the MONITOR OUTPUT jack will be in black and white (monochrome).

Connecting the Video Equipment

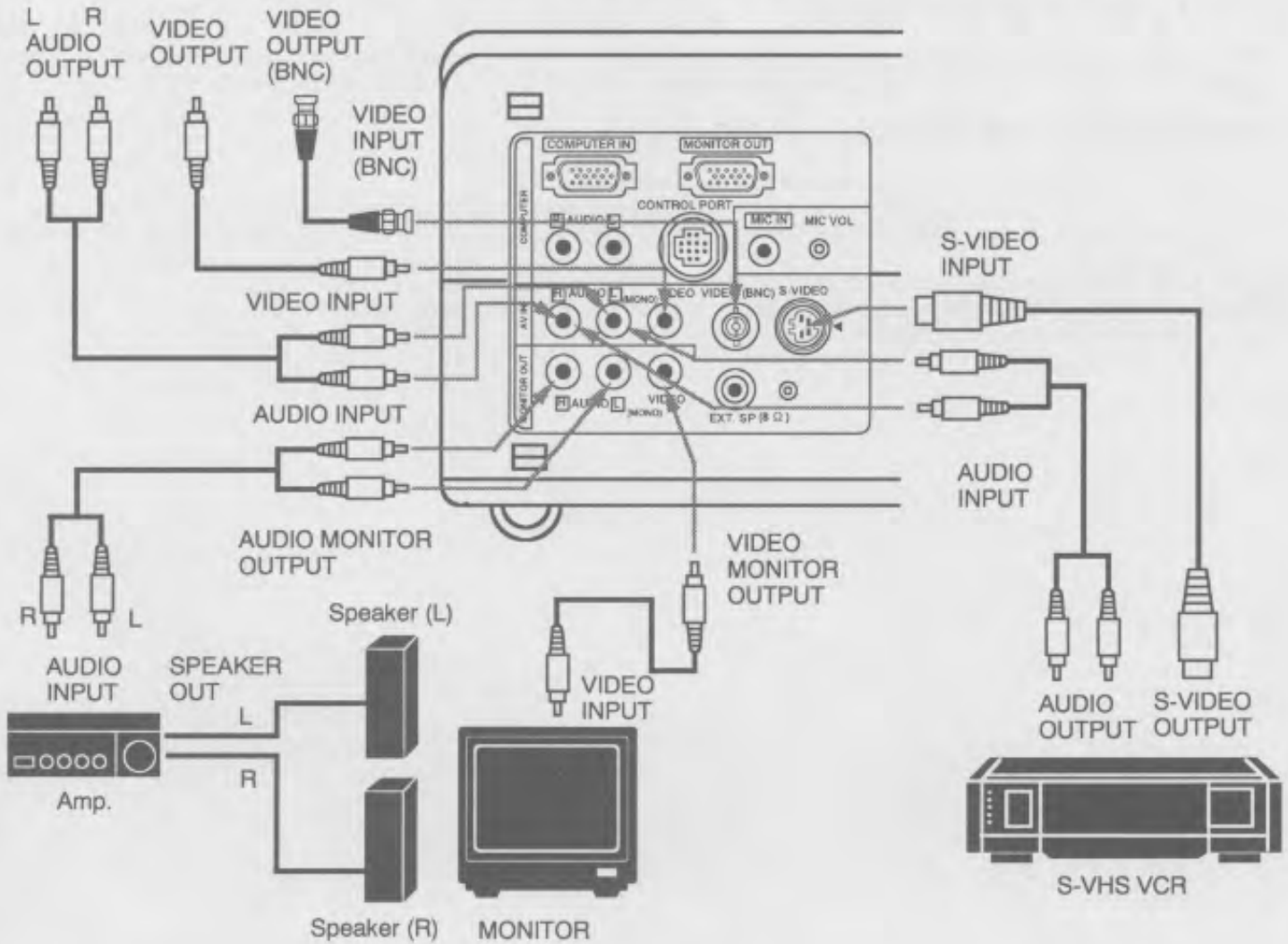

NOTE: The hook up should be done as per the above illustration. After hook up, turn on the projector, video equipment, in that order.

CONNECTING AN EXTERNAL SPEAKER AND MICROPHONE

CONNECTING TO THE EXT. SP. JACK (3.5mm mini stereo type)

This jack contain the audio information that is viewed on the screen. Use to connect a external speakers system when using this jack, turn off the audio from the internal speaker.

MICROPHONE CONNECTION

The Microphone jack (mini type) are provided projector.

- Connect the microphone into the microphone jack.
- Turn the MIC VOLUME control to adjust the microphone volume.

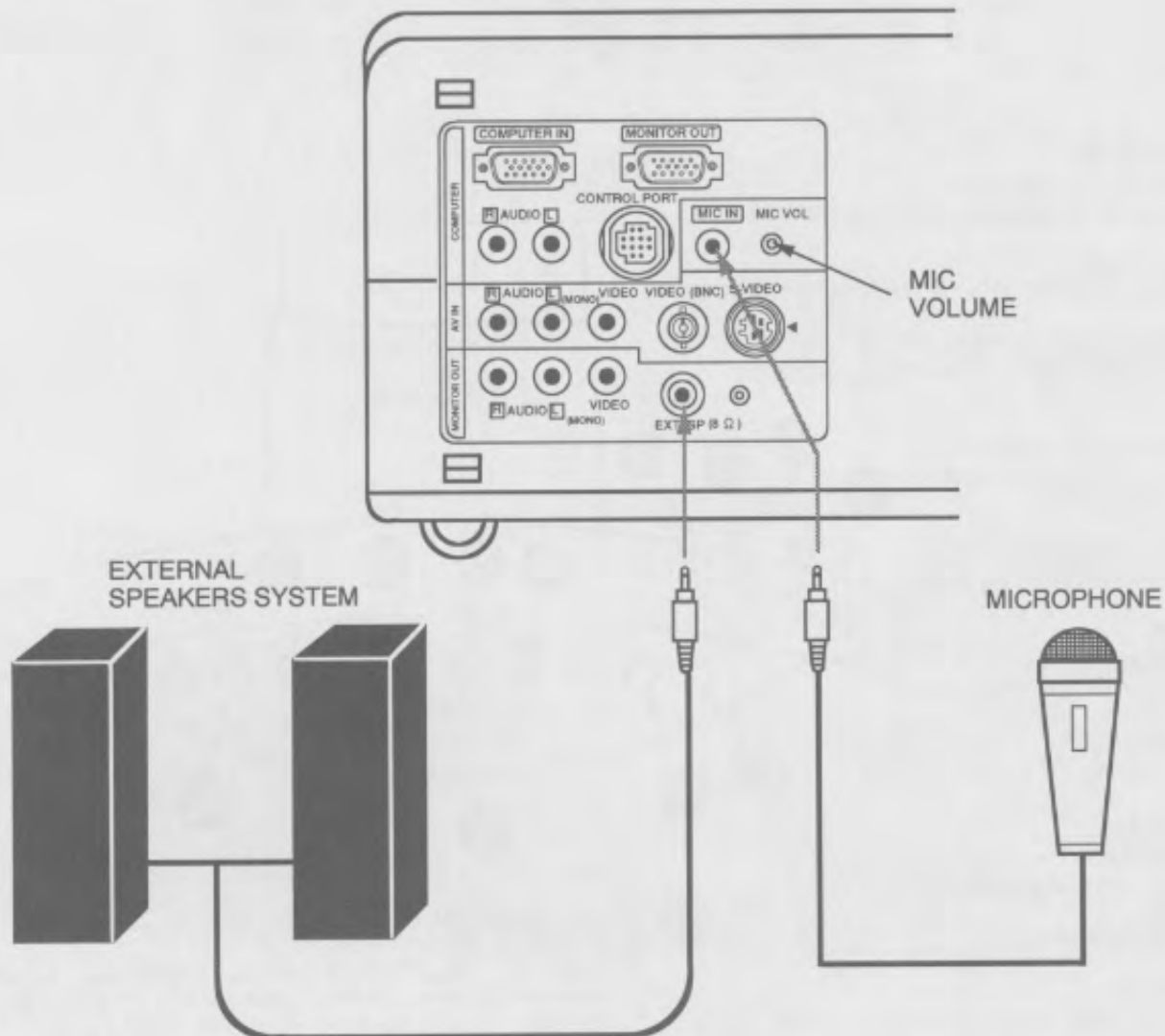

OPERATION OF CONTROLS

TOP OF THE PROJECTOR

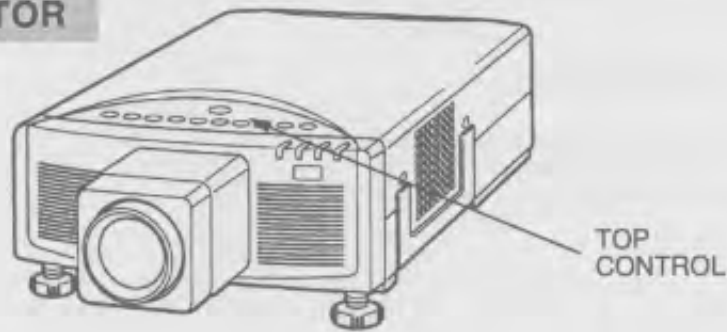

- 1 POWER INDICATORS**
Lights dim when the projector is on.
Lights bright when the projector is stand-by position.
- 2 READY INDICATORS**
Lights green when projector lamp is ready to be turned on.
- 3 TEMPERATURE WARNING INDICATOR**
Flashes red when internal projector temperature is too high.

- 4 LAMP REPLACEMENT INDICATOR**
Lights orange when projection lamp is nearing end of service life.
- 5 POWER (LAMP) ON/OFF BUTTON**
Used to turn projection lamp on or off.

- 6 MODE BUTTON**
Used to select video source.
(Computer Input or VIDEO Input)

- 7 VOLUME BUTTONS**
Used to adjust volume.

- 8 SYSTEM BUTTON**
 - **Computer Mode**
Used to select computer system.
 - **VIDEO Mode**
Used to select color system.

- 9 SETTING BUTTON**
Used to setting the auto retract, reverse scan T/B, reverse scan L/R, blueback and display.

- 10 MENU BUTTON**
 - **Computer Mode**
Used to adjust picture image.
(brightness, contrast, horizontal position, vertical position and fine sync.)
 - **VIDEO Mode**
Used to adjust picture image.
(color, tint, contrast, brightness and sharpness.)

- 11 LEVEL CONTROL BUTTONS**
 - **Computer Mode**
Used to adjust zoom, focus, brightness, contrast, horizontal position, vertical position, fine sync and setting the auto retract, reverse scan T/B, reverse scan L/R, blueback and display by pressing + or - button.
 - **VIDEO Mode**
Used to adjust zoom, focus, color, tint, contrast, brightness, sharpness and setting the auto retract, reverse scan T/B, reverse scan L/R, blueback and display by pressing + or - button.

- 12 ZOOM/FOCUS BUTTON**
Used to select power zoom lens or focus adjust.

- 13 NORMAL BUTTON**
Used to reset to normal picture adjustment preset by factory.

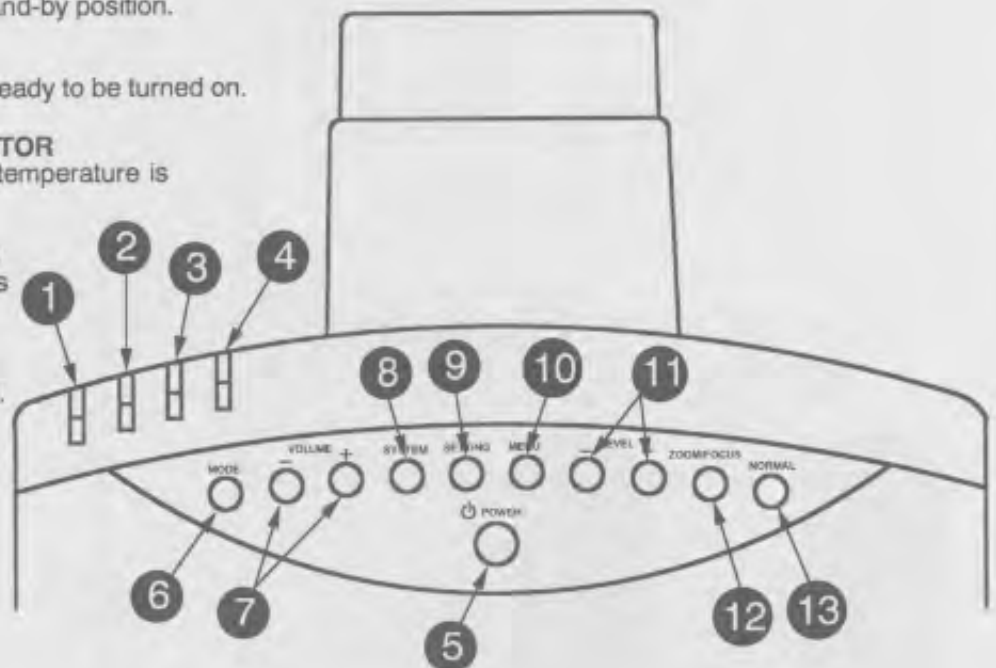

SIDE OF THE PROJECTOR

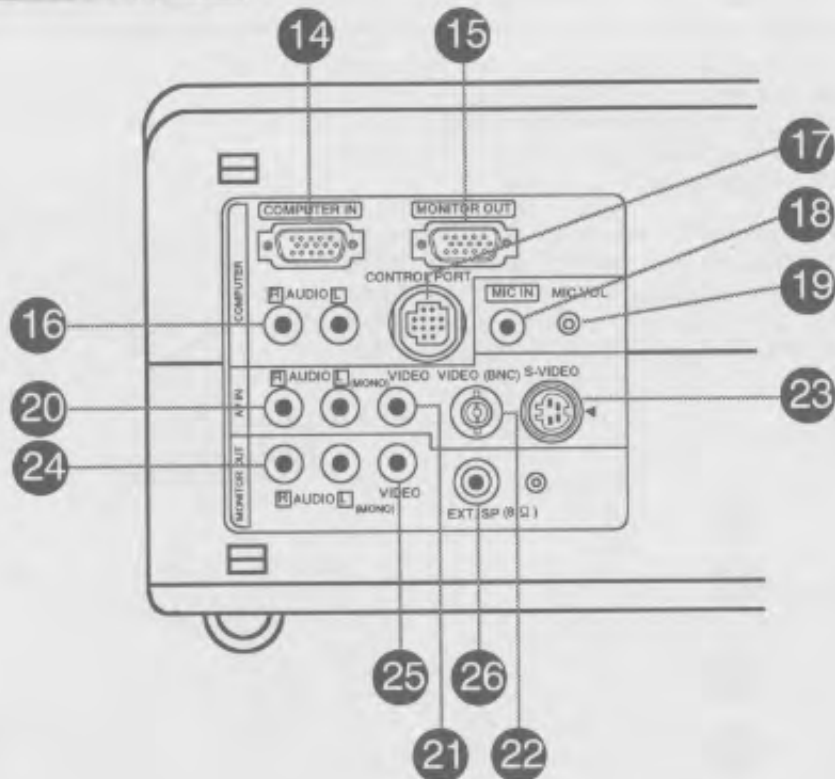

- 14 COMPUTER INPUT TERMINAL**
Used to connect a computer to the projector.
- 15 MONITOR OUTPUT TERMINAL**
Used to connect a monitor to the projector.
- 16 COMPUTER AUDIO INPUT JACKS**
Used to connect a computer audio input to the projector.
- 17 CONTROL PORT CONNECTOR**
Used to connect a computer to the projector.
- 18 MICROPHONE JACK**
Used to connect the microphone.
- 19 MICROPHONE VOLUME**
Used to adjust the microphone volume.
- 20 AUDIO INPUT JACKS**
Used to connect an audio input to the projector.
- 21 VIDEO INPUT JACK**
Used to connect a video source to the projector.
- 22 VIDEO INPUT (BNC) JACK**
Used to connect a video source to the projector.
- 23 S-VIDEO INPUT JACK**
Used to connect a S-VHS video source to the projector.
- 24 AUDIO MONITOR OUTPUT JACKS**
Permits audio connection to a monitor.
- 25 VIDEO MONITOR OUTPUT JACK**
Permits video connection to a monitor.
- 26 EXT. SP. JACK (3.5 mm mini stereo type)**
Used to connect a external speakers system.

OPERATION OF REMOTE CONTROL

This remote control unit can be used not only as a remote control for the projector operation but also as a wireless mouse for PC. The remote control unit has a pointing pad and two click buttons. The wireless mouse function is activated when you do not adjust the setting by using the MENU operation.

NOTE: To use the wireless mouse function, connect the attached cable between the projector and your PC since the mouse control signal is transferred through the projector. Use the proper cable and follow the instruction as described in section "CONNECTING THE PROJECTOR" on pages 10 ~ 14 depending on your PC.

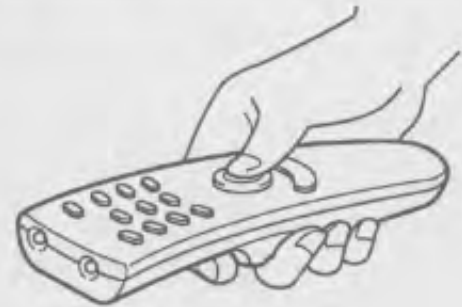

FRONT

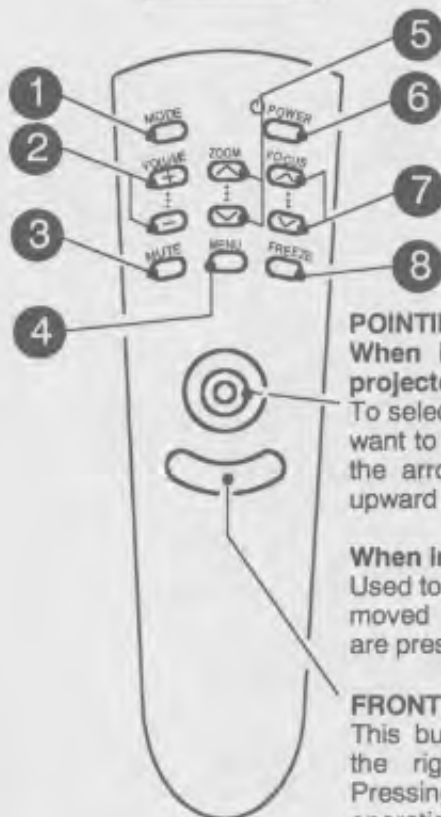

POINTING PAD (POINT BUTTON)
When in use as a remote for the projector.
 To select an item on the MENU that you want to adjust. To select an item, move the arrow by pressing the pad either upward or downward.

When in use as a wireless mouse
 Used to move the pointer. The pointer is moved according to the direction you are pressing.

FRONT CLICK BUTTON
 This button has the same function as the right button in a PC mouse. Pressing this button does not affect any operation when in MENU mode.

SIDE



REAR CLICK BUTTON
When in use as a remote for the projector.

This button has different functions depending on when used. This button is used to execute the item selected, to increase or decrease the values in certain items such as COLOR or BRIGHTNESS.

When in use as a wireless mouse
 This button has the same function as the left button in a PC mouse.

1 MODE BUTTON
 Used to select video source. (Computer Input or VIDEO Input)

2 VOLUME BUTTONS
 Used to adjust volume.

3 SOUND MUTE BUTTON
 Used to mute sound.

4 MENU BUTTON
 This button will activate the MENU operation. Use this button, the point button and the rear click button to make adjustments to the projector's setting in MENU operation.

5 ZOOM BUTTONS
 Used to operate power zoom lens.

6 POWER (LAMP) ON/OFF BUTTON
 Used to turn the projection lamp on or off.

7 FOCUS BUTTONS
 Used to operate power focus system.

8 FREEZE BUTTON
 Use this button to freeze on-screen image.

REMOTE CONTROL BATTERY INSTALLATION

1 Remove the battery compartment lid.



2 Slide the batteries into the compartment.

Note: For correct polarity (+ and - terminal), be sure the battery terminals are in contact with the pins in the compartment.

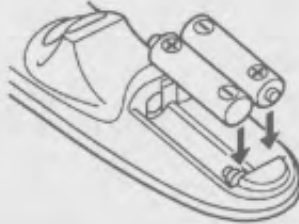

3 Replace the compartment lid.



USING THE REMOTE CONTROL UNIT

Point the remote control toward the projector (Receiver window) whenever pressing the buttons. Maximum operating range for the remote control is about 16.4' (5m) and 60° front and back of the projector.

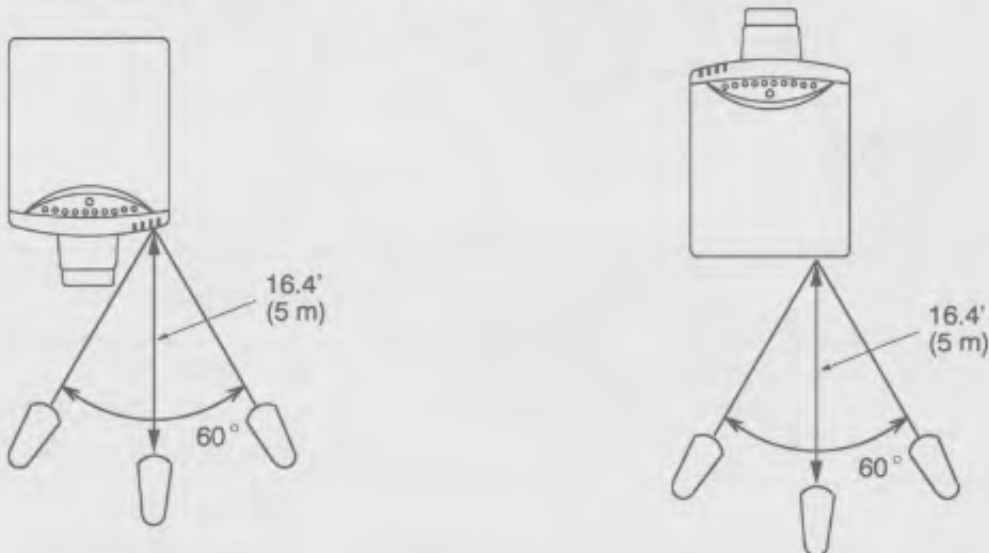

To insure safe operation, please observe the following precautions:

- Use (2) AA type manganese or alkaline batteries.
- Change two batteries at the same time.
- Do not use a new battery with a used battery.
- Avoid contact with water.
- Do not drop the remote control unit.
- If batteries have leaked on the remote control, carefully wipe the case clean and load new batteries.

CONTROL THE PROJECTOR

The projector has two types of operation: DIRECT OPERATION and MENU OPERATION. DIRECT OPERATION allows you to operate the projector by using one button without showing the MENU. In MENU OPERATION mode, you display menus where you can adjust the projector's settings. Follow the instruction for each control.

DIRECT OPERATION

ADJUST ITEM	TOP CONTROL OF THE PROJECTOR	REMOTE CONTROL UNIT
POWER (LAMP) ON/OFF	POWER BUTTON	POWER BUTTON
VIDEO MODE SELECT	MODE BUTTON	MODE BUTTON
VOLUME ADJUSTMENT	VOLUME (+) and (-) BUTTONS	VOLUME (+) and (-) BUTTONS
SOUND MUTE	NOT AVAILABLE	MUTE BUTTON
ZOOM ADJUSTMENT	ZOOM/FOCUS BUTTON LEVEL (+) and (-) BUTTONS	ZOOM (+) and (-) BUTTONS
FOCUS ADJUSTMENT	ZOOM/FOCUS BUTTON LEVEL (+) and (-) BUTTONS	FOCUS (+) and (-) BUTTONS
NORMAL PICTURE	NORMAL BUTTON	NOT AVAILABLE
FREEZE PICTURE	NOT AVAILABLE	FREEZE BUTTON
COLOR SYSTEM	SYSTEM BUTTON	Refer to the Menu operation.

MENU OPERATION

1. COMPUTER MODE

ADJUST ITEM	TOP CONTROL OF THE PROJECTOR	REMOTE CONTROL UNIT
COMPUTER SYSTEM	SYSTEM BUTTON LEVEL (+) BUTTONS	MENU BUTTON POINT (UP/DOWN) BUTTON REAR CLICK BUTTON
PICTURE IMAGE BRIGHTNESS CONTRAST H-POSITION V-POSITION FINE SYNC.	MENU BUTTON LEVEL (+) and (-) BUTTONS	MENU BUTTON POINT (UP/DOWN) BUTTON REAR CLICK BUTTON
PICTURE SCREEN	NOT AVAILABLE	MENU BUTTON POINT (UP/DOWN) BUTTON REAR CLICK BUTTON
PC ADJUSTMENT	SETTING BUTTON LEVEL (+) and (-) BUTTONS	MENU BUTTON POINT (UP/DOWN) BUTTON REAR CLICK BUTTON

2. VIDEO MODE

ADJUST ITEM	TOP CONTROL OF THE PROJECTOR	REMOTE CONTROL UNIT
COLOR SYSTEM	SYSTEM BUTTON (Refer to the Direct operation)	MENU BUTTON POINT (UP/DOWN) BUTTON REAR CLICK BUTTON
PICTURE IMAGE COLOR TINT CONTRAST BRIGHTNESS SHARPNESS	MENU BUTTON LEVEL (+) and (-) BUTTONS	MENU BUTTON POINT (UP/DOWN) BUTTON REAR CLICK BUTTON
PICTURE SCREEN	NOT AVAILABLE	MENU BUTTON POINT (UP/DOWN) BUTTON REAR CLICK BUTTON

3. COMPUTER/VIDEO MODE

ADJUST ITEM	TOP CONTROL OF THE PROJECTOR	REMOTE CONTROL UNIT
OTHER FUNCTION AUTO RETRACT REVERSE SCAN T/B REVERSE SCAN L/R BLUE BACK DISPLAY	SETTING BUTTON LEVEL (+) and (-) BUTTONS	MENU BUTTON POINT (UP/DOWN) BUTTON REAR CLICK BUTTON
LANGUAGE	NOT AVAILABLE	

NOTES;

1. The MENU once activated will not disappear unless you have done the QUIT operation. If you switch the DIRECT operation by pressing a DIRECT operation button during in MENU mode, the menus will disappear and the MENU operation will end.
2. You can use the REMOTE CONTROL UNIT or the TOP CONTROL OF THE PROJECTOR to operate the MENU operation. The ways are different from one another.
3. You cannot make adjustments to items that are not displayed in highlighted letters (or written in gray letters).

USING THE PROJECTOR

TO TURN ON THE PROJECTOR

Connect the projector to a video source (Computer, VCR, Video Camera, Video Disc Player, etc.) using the appropriate terminals on the side of the projector (See "CONNECTING THE PROJECTOR" section on page 10-17).

Connect the projector's AC power cord into a wall outlet and turn the MAINS ON/OFF switch (located on the back of the projector) to ON position. The POWER indicator will light RED, READY indicator will light GREEN and the cooling fan will operate.

Press the POWER (LAMP) ON/OFF button on the remote control unit or on the projector to ON. The POWER indicator will light dim and the other two cooling fan will operate. The wait display (Logo mark and numeral) appears on the screen and the count-down starts (20-19-18-...1). The signal from the video source appears after 30 seconds.



CAUTION:

THIS PROJECTOR USES A METAL-HALIDE ARC LAMP. IF YOU TURN ON THE LAMP, DO NOT TURN IT OFF FOR AT LEAST 5 MINUTES SO THAT ITS LIFE WILL NOT GET SHORTER.

NOTE: TEMPERATURE WARNING INDICATOR flashes red, the projector will automatically turn off. Wait at least 5 minutes before turning the projector on.

If the TEMPERATURE WARNING INDICATOR continues to flash, follow the procedures below:

- (1). Press POWER (LAMP) ON/OFF button to OFF.
- (2). Check the air filter for dust accumulation.
- (3). Remove dust with vacuum cleaner (See "AIR FILTER CARE AND CLEANING" section on page 40.)
- (4). Press POWER (LAMP) ON/OFF button to ON.

If the TEMPERATURE WARNING INDICATOR still continues to flash, call your authorized dealer or service station.

TO TURN OFF THE PROJECTOR

Press the POWER (LAMP) ON/OFF button on the remote control unit or on the projector. The POWER OFF ?" appears on the screen. Press again the POWER (LAMP) ON/OFF button to OFF the projector. The POWER indicator will light bright and READY indicator will turn off. The two cooling fan will operate for 1 minute after the projector is turned off. (During this "cooling down" period, the projector can not be turned on.) The READY indicator will light green again and the projector may be turned on by pressing the POWER (LAMP) ON/OFF button.

POWER OFF ?

VIDEO MODE SELECT

Press the MODE button (located on remote control unit or on the projector) to select Computer Input or VIDEO Input. The "COMPUTER" or "VIDEO" display will be displayed at the bottom right of the screen for a few seconds.

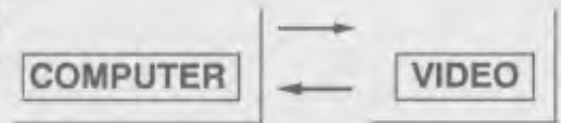

VOLUME ADJUSTMENT

Press VOLUME buttons (located on remote control unit or on the projector) to adjust the volume. The volume display displayed at the bottom right of the screen for a few seconds.

Pressing volume (+) will increase volume and increase the numeral on the screen. Pressing volume (-) will decrease volume and decrease the numeral on the screen.

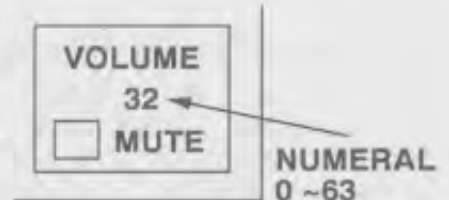

SOUND MUTE FUNCTION

Pressing MUTE button on the remote control unit will mute audio. Press MUTE button again to restore audio to its previous level. The mute display will be displayed at the bottom right of the screen for a few seconds.



ZOOM ADJUSTMENT (With remote control unit)

Press ZOOM (^) or (v) button on the remote control unit to obtain your desired picture size. The zoom display will be displayed at the bottom right of the screen for a few seconds.

For a larger picture, press (^) and for a smaller picture, press (v).

ZOOM ADJUSTMENT (Without remote control unit)

Press ZOOM/FOCUS button on the projector until zoom display appears on the screen, and press LEVEL (+) or (-) to obtain your desired picture size. The zoom display will be displayed at the bottom right of the screen for a few seconds.

For a larger picture, press (+) and for a smaller picture, press (-).

ZOOM

FOCUS ADJUSTMENT (With remote control unit)

Press FOCUS (^) or (v) button on the remote control unit for sharper, crisper picture. The focus display will be displayed at the bottom right of the screen for a few seconds.

FOCUS ADJUSTMENT (Without remote control unit)

Press ZOOM/FOCUS button on the projector until focus display appears on the screen, and press LEVEL (+) or (-) for sharper, crisper picture. The focus display will be displayed at the bottom right of the screen for a few seconds.

FOCUS

NORMAL PICTURE FUNCTION

The normal picture level is factory preset on the projector and can be obtained anytime by pressing the NORMAL button on the projector. The normal display will be displayed at the bottom right of the screen for a few seconds.

FREEZE PICTURE FUNCTION

Press the FREEZE button on the remote control unit, and then, the still picture will remain on-screen. This function is cancelled when the FREEZE button is pressed again or any other function button is pressed.

NOTE: Your computer or video equipment is not affected by this function, and will continue to run.

NORMAL

COMPUTER SYSTEM SELECT (COMPUTER MODE)

This projector is designed to adjust itself to different type of computer display signals based on VGA, SVGA or XGA (See COMPATIBLE PERSONAL COMPUTER SPECIFICATIONS on next page). If you switch VIDEO MODE SELECT to "COMPUTER", the set will automatically process the incoming signal and project the proper image without any special setting. Although this will work in most cases, you may require the manual setting for some computer signals. If the computer image is not reproduced properly, try the following procedure and switch to computer display mode that you want to use. You can alter the system by either the REMOTE CONTROL UNIT and the TOP CONTROL of the projector. The ways are different from one another.

USE REMOTE CONTROL UNIT

1. Connect the COMPUTER and the PROJECTOR, and turn them on.
2. Press the MODE BUTTON to set COMPUTER MODE.
3. Press the MENU BUTTON and the MAIN MENU DISPLAY dialog box will appear.
4. Move the arrow by pressing the POINT BUTTON (UP/DOWN) to select SYSTEM. Press the REAR CLICK BUTTON and another dialog box, COMPUTER SYSTEM DISPLAY will appear. This shows the current display mode initially detected by the projector.
5. If you want to change the display mode from the current one, point the arrow to the SEARCH and press the REAR CLICK BUTTON and select one among possible alternatives shown in the top row.
6. To quit the MENU, point to the QUIT and press the REAR CLICK BUTTON.

NOTE: If the projector cannot discriminate or detect the input signal from the computer, the "NOT COMPATIBLE" appears.

MAIN MENU DISPLAY



COMPUTER SYSTEM DISPLAY

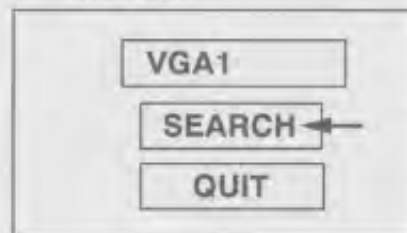

USE TOP CONTROL OF THE PROJECTOR

1. Connect the COMPUTER and the PROJECTOR, and turn them on.
2. Press the MODE BUTTON to set COMPUTER MODE.
3. Press the SYSTEM BUTTON and COMPUTER SYSTEM DISPLAY will appear. This shows the current display mode initially detected by the projector.
4. If you want to change the display mode from the current one, point the arrow to the SEARCH by pressing LEVEL (+) BUTTON, and select one among possible alternatives shown in the top row.
5. To quit the MENU, point to QUIT by pressing SYSTEM BUTTON and press the LEVEL (+) BUTTON.

COMPUTER SYSTEM DISPLAY

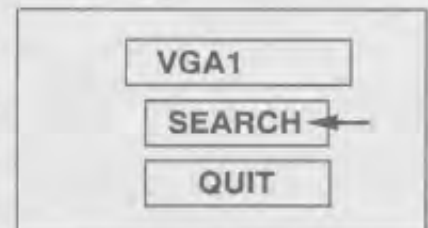

NOTE: If the projector cannot discriminate or detect the input signal from the computer, the "NOT COMPATIBLE" appears.

COMPATIBLE PERSONAL COMPUTER SPECIFICATIONS

ON-SCREEN DISPLAY	RESOLUTION	Horizontal Frequency (kHz)	Vertical Frequency (Hz)
VGA1	640 × 480	31.47	59.94
VGA2	720 × 400	31.47	70
VGA3	640 × 400	31.47	70
VGA4	640 × 480	37.9	74.4
VGA5	640 × 480	37.86	72.81
MAC LC13	640 × 480	34.97	66.66
MAC 13	640 × 480	35.00	66.68
PC98	640 × 400	24.83	56.42
FM TOWNS	640 × 400	24.37	55.37
SVGA1	800 × 600	35.21	56.43
SVGA2	800 × 600	38.02	60
SVGA3	800 × 600	46.94	74.85
SVGA4	800 × 600	48.3	72
SVGA5	800 × 600	48.02	72
MAC 16	832 × 624	49.72	74.55
XGA1	1024 × 768	48.3	60
XGA2	1024 × 768	56.286	70.3
XGA3	1024 × 768	60.09	75.07
XGA4	1024 × 768	56.49	70

Specifications are subject to change without notice.

PICTURE IMAGE ADJUSTMENT (COMPUTER MODE)

Although picture adjustments have been preset at the factory to our standards, you may want to change the setting. You can make adjustments to the picture image by either the REMOTE CONTROL UNIT or the TOP CONTROL of the projector. The ways are different from one another.

USE REMOTE CONTROL UNIT

1. Press the MENU BUTTON and the MAIN MENU DISPLAY dialog box will appear.
2. Move the arrow by pressing the POINT BUTTON (UP/DOWN) to select the IMAGE. Press the REAR CLICK BUTTON and another dialog box, IMAGE ADJUST DISPLAY will appear. This shows the current picture settings.
3. In this dialog box, you can adjust the settings concerning to the picture image by increasing or decreasing the levels shown as numbers. The items and the range of the levels that you can adjust are summarized in the table on the next page.
4. Move the arrow to an item that you want to adjust by pressing the POINT BUTTON (UP/DOWN).
5. To increase the level, point the arrow to Δ and press the REAR CLICK BUTTON. To decrease the level, point the arrow to ∇ and press the REAR CLICK BUTTON.
6. You may want to store the settings to the memory so that you can recall them when you need. To store the settings, move the arrow to the MEMORY and press the REAR CLICK BUTTON. When you have stored the settings, you will see "OK !" as a confirmation. Press the REAR CLICK BUTTON then to quit. The stored settings are permanently held even if the MAINS ON/OFF is switched off.
7. If you do not want to store the settings, move the arrow to the QUIT and press the REAR CLICK BUTTON to quit. The settings changed are temporarily effective until you turn off the MAINS ON/OFF switch.
8. To recall the settings from the memory that you have stored by the MEMORY, move the arrow to the RESET and press the REAR CLICK BUTTON. You can adjust the settings if you need even after recalling.

MAIN MENU DISPLAY

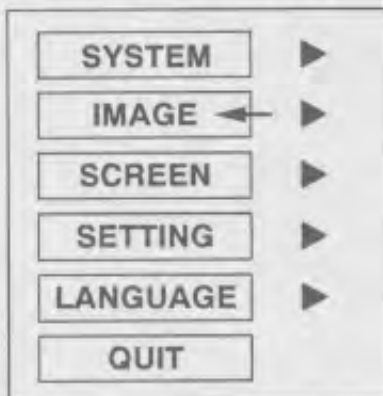
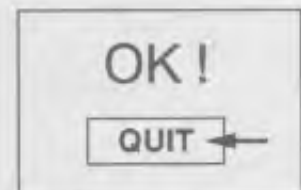
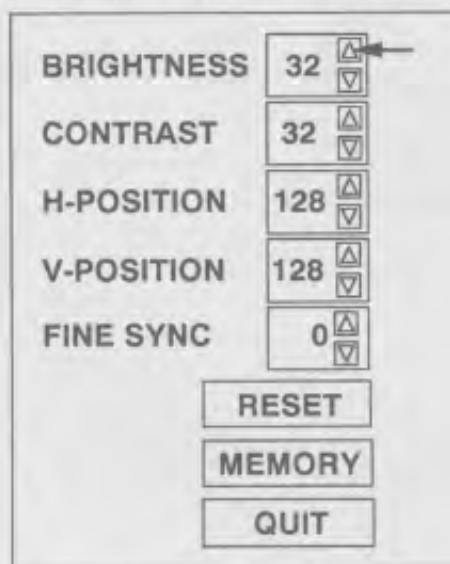

IMAGE ADJUST DISPLAY



USE TOP CONTROL OF THE PROJECTOR

1. Press the MENU BUTTON and the IMAGE ADJUST DISPLAY dialog box will appear. This shows the current picture settings.
2. You can adjust the various settings concerning to the picture image by increasing or decreasing the levels shown as numbers. The items and the range of the levels that you can adjust are summarized in the table below.
3. Move the arrow to an item that you want to adjust by pressing the MENU BUTTON. The arrow will cyclically move downwards one by one each time the MENU BUTTON is pressed.
4. To increase the level, press LEVEL (+) BUTTON. To decrease the level, press LEVEL (-) BUTTON.
5. You may want to store the settings to the memory so that you can recall them when you need. To store the settings, move the arrow to the MEMORY and press the LEVEL (+) BUTTON. When you have stored the settings, you will see "OK !" as a confirmation. Press the LEVEL (+) BUTTON then to quit. The stored settings are permanently held even if the MAINS ON/OFF is switched off.
6. If you do not want to store the settings, move the arrow to the QUIT and press the LEVEL (+) BUTTON to quit. The settings changed are temporarily effective until you turn off the MAINS ON/OFF switch.
7. To recall the settings from the memory that you have stored by the MEMORY, move the arrow to the RESET and press the LEVEL (+) BUTTON. You can adjust the settings if you need even after recalling.

IMAGE ADJUST DISPLAY

BRIGHTNESS	32	▲	←	▼
CONTRAST	32	▲		▼
H-POSITION	128	▲		▼
V-POSITION	128	▲		▼
FINE SYNC	0	▲		▼
RESET				
MEMORY				
QUIT				

<p>OK !</p> <p>QUIT ←</p>

TABLE OF PICTURE IMAGE ADJUSTMENT

BRIGHTNESS	DARKER	0 ↔ 63	BRIGHTER
CONTRAST	LIGHTER	0 ↔ 63	DEEPER
H. POSITION	RIGHT	0 ↔ 255	LEFT
V. POSITION	DOWNWARD	0 ↔ 255	UPWARD
FINE SYNC	Adjust the picture as necessary to eliminate flicker from the display.		0 ↔ 127

NOTE: The projector may not reproduce a proper image for some XGA signals. Since XGA (1024 × 768) image is converted to SVGA (800 × 600) image by partial scan, some lines and dots of the image do not appear. Some video noise of flicker on this compressed XGA image cannot be eliminated even though you try to make a FINE SYNC adjustment.

PICTURE SCREEN ADJUSTMENT (COMPUTER MODE)

This projector has an expanding function, which enables you to project the VGA image in the full screen size.

Expanding function

Although this projector can project a VGA (640 × 480) image without any setting, the image projected is relatively small compared to a SVGA (800 × 600) image since the number of the pixels of a VGA image are smaller than that of a SVGA image. A VGA image is produced by using some part of SVGA area as shown in the illustration below. To avoid this, this projector provide the expanding function to see the full sized VGA image. You can choose either "FINE", where the normal VGA image is projected or "EXPAND", where the full-sized VGA image is projected.

This adjustment is made by only the REMOTE CONTROL UNIT.

1. Press the MODE BUTTON to set COMPUTER MODE.
2. Press the MENU BUTTON and the MAIN MENU DISPLAY dialog box will appear.
3. Move the arrow by pressing the POINT BUTTON (UP/DOWN) to select the SCREEN. Press the REAR CLICK BUTTON and another dialog box, SCREEN ADJUST DISPLAY will appear.
4. To switch the "EXPAND MODE", move the arrow to the EXPAND by pressing the POINT BUTTON (UP/DOWN) and press the REAR CLICK BUTTON.
5. To switch the "FINE MODE", move the arrow to the FINE by pressing the POINT BUTTON (UP/DOWN) and press the REAR CLICK BUTTON.
6. The "EXPAND" settings is temporarily effective until you turn off the MAINS ON/OFF switch.
7. To quit the MENU, move the arrow to the QUIT and press the REAR CLICK BUTTON.

MAIN MENU DISPLAY

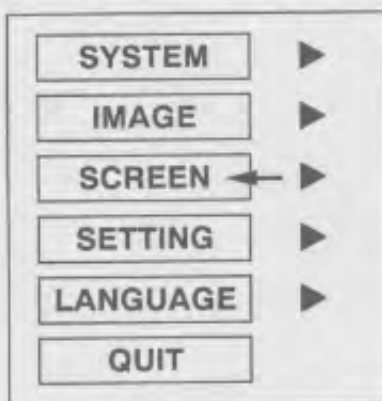

SCREEN ADJUST DISPLAY

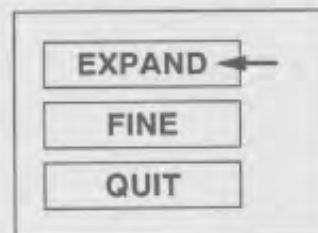

FINE MODE

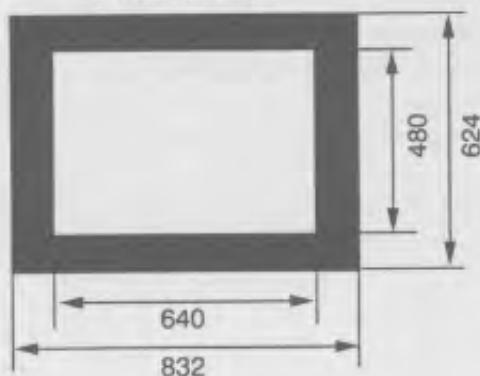

EXPAND MODE

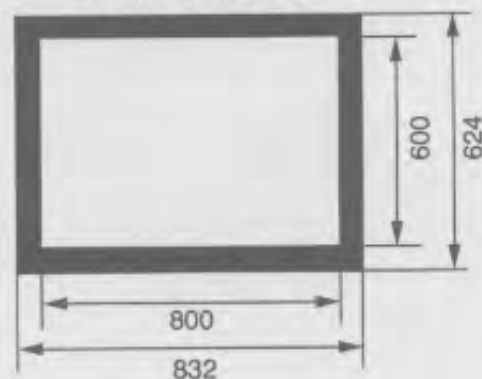

COLOR SYSTEM SELECT (VIDEO MODE)

This projector is compatible with the four major broadcasts video standards: PAL, SECAM, NTSC or NTSC 4.43 (COLOR SYSTEMS). It automatically adjusts to optimize its performance for the incoming video. However, if the video signal is not strong enough to detect the video format, the projector may not reproduce the proper video image. In case this happens, this projector allows you to lock the projector to a specific broadcast signal format. You can select the COLOR SYSTEM by either the REMOTE CONTROL UNIT or the TOP CONTROL of the projector. The ways are different from one another.

USE REMOTE CONTROL UNIT

1. Connect a video equipment and the PROJECTOR, and turn them on.
2. Press the MODE BUTTON to set VIDEO MODE.
3. Press the MENU BUTTON and the MAIN MENU DISPLAY dialog box will appear.
4. Move the arrow by pressing the POINT BUTTON (UP/DOWN) to select the SYSTEM. Press the REAR CLICK BUTTON and another dialog box, COLOR SYSTEM DISPLAY will appear. The current COLOR SYSTEM is displayed at the bottom right of the screen.
5. If you want to change the COLOR SYSTEM from the current one, move the arrow to the system that you want to select and press the REAR CLICK BUTTON.
6. To quit the MENU, point to the QUIT and press the REAR CLICK BUTTON.
7. The setting changed is temporarily effective until you turn off the MAINS ON/OFF switch.

NOTE: The color system you can select are highlighted in COLOR SYSTEM DISPLAY. Some projectors distributed in certain areas allow you to select *limited* systems.

MAIN MENU DISPLAY

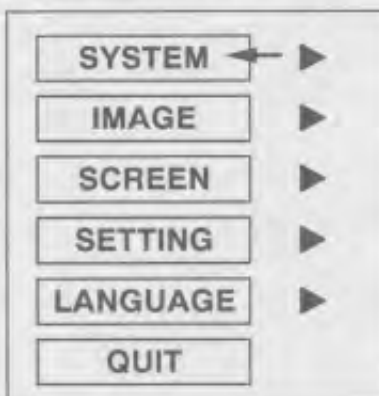

COLOR SYSTEM DISPLAY

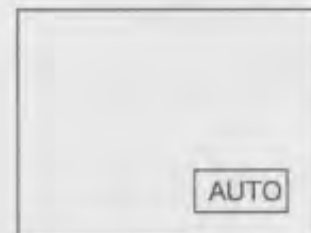
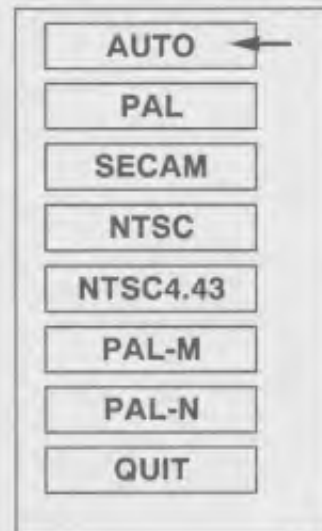

USE TOP CONTROL OF THE PROJECTOR

1. Connect a video equipment and the PROJECTOR, and turn them on.
2. Press the MODE BUTTON to set VIDEO MODE.
3. Press the SYSTEM BUTTON and the current setting will be displayed at the bottom right of the screen for a few seconds.
4. If you want to change the setting, press the SYSTEM BUTTON to select. The COLOR SYSTEM will be cyclically changed each time the SYSTEM BUTTON is pressed.

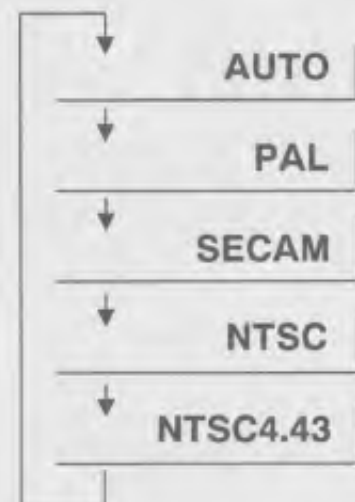

PICTURE IMAGE ADJUSTMENT (VIDEO MODE)

Although picture adjustments have been preset at the factory to our standards, you may want to change the setting. You can make adjustments to the picture image by either the REMOTE CONTROL UNIT or the TOP CONTROL of the projector. The ways are different from one another.

USE REMOTE CONTROL UNIT

1. Press the MENU BUTTON and the MAIN MENU DISPLAY dialog box will appear.
2. Move the arrow by pressing the POINT BUTTON (UP/DOWN) to select the IMAGE. Press the REAR CLICK BUTTON and another dialog box, IMAGE ADJUST DISPLAY will appear. This shows the current picture settings.
3. In this dialog box, you can adjust the settings concerning to the picture image by increasing or decreasing the levels shown as numbers. The items and the range of the levels that you can adjust are summarized in the table on the next page.
4. Move the arrow to an item that you want to adjust by pressing the POINT BUTTON (UP/DOWN).
5. To increase the level, point the arrow to Δ and press the REAR CLICK BUTTON. To decrease the level, point the arrow to ∇ and press the REAR CLICK BUTTON.
6. You may want to store the settings to the memory so that you can recall them when you need. To store the settings, move the arrow to the MEMORY and press the REAR CLICK BUTTON. When you have stored the settings, you will see "OK !" as a confirmation. Press the REAR CLICK BUTTON then to quit. The stored settings are permanently held even if the MAINS ON/OFF is switched off.
7. If you do not want to store the settings, move the arrow to the QUIT and press the REAR CLICK BUTTON to quit. The settings changed are temporarily effective until you turn off the MAINS ON/OFF switch.
8. To recall the settings from the memory that you have stored by the MEMORY, move the arrow to the RESET and press the REAR CLICK BUTTON. You can adjust the settings if you need even after recalling.

MAIN MENU DISPLAY



IMAGE ADJUST DISPLAY

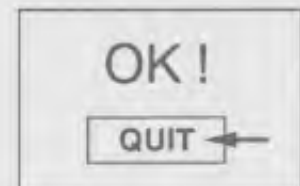

USE TOP CONTROL OF THE PROJECTOR

1. Press the MENU BUTTON and the IMAGE ADJUST DISPLAY dialog box will appear. This shows the current picture settings.
2. You can adjust the various settings concerning to the picture image by increasing or decreasing the levels shown as numbers. The items and the range of the levels that you can adjust are summarized in the table below.
3. Move the arrow to an item that you want to adjust by pressing the MENU BUTTON. The arrow will cyclically move downwards one by one each time the MENU BUTTON is pressed.
4. To increase the level, press LEVEL (+) BUTTON. To decrease the level, press LEVEL (-) BUTTON.
5. You may want to store the settings to the memory so that you can recall them when you need. To store the settings, move the arrow to the MEMORY and press the LEVEL (+) BUTTON. When you have stored the settings, you will see "OK !" as a confirmation. Press the LEVEL (+) BUTTON then to quit. The stored settings are permanently held even if the MAINS ON/OFF is switched off.
6. If you do not want to store the settings, move the arrow to the QUIT and press the LEVEL (+) BUTTON to quit. The settings changed are temporarily effective until you turn off the MAINS ON/OFF switch.
7. To recall the settings from the memory that you have stored by the MEMORY, move the arrow to the RESET and press the LEVEL (+) BUTTON. You can adjust the settings if you need even after recalling.

NOTE: "TINT" will be skipped during in the PAL and SECAM mode.

IMAGE ADJUST DISPLAY

COLOR	32	▲	→
		▼	
TINT	32	▲	
		▼	
CONTRAST	32	▲	
		▼	
BRIGHTNESS	32	▲	
		▼	
SHARPNESS	44	▲	
		▼	
<input type="button" value="RESET"/>			
<input type="button" value="MEMORY"/>			
<input type="button" value="QUIT"/>			

<p>OK !</p> <input type="button" value="QUIT"/> ←
--

TABLE OF PICTURE IMAGE ADJUSTMENT

COLOR	DECREASES	0 ↔ 63	INCREASES
TINT	MORE PURPLE	0 ↔ 63	MORE GREEN
CONTRAST	LIGHTER	0 ↔ 63	DEEPER
BRIGHTNESS	DARKER	0 ↔ 63	BRIGHTER
SHARPNESS	SOFTER	0 ↔ 63	SHARPER

PICTURE SCREEN ADJUSTMENT (VIDEO MODE)

This projector has a WIDE function, which enables you to view a wider video image.

WIDE function

This projector is designed to project a normal video image (with 4 x 3 aspect ratio). In addition, with the WIDE function, the projector can project a wider video image by decreasing 4 x 3 image in vertical size. This feature may be used by those who want to enjoy watching a movie with a cinema-like image. You can switch to either WIDE or REGULAR screen mode.

This setting is made by only the REMOTE CONTROL UNIT.

1. Press the MODE BUTTON to set VIDEO MODE.
2. Press the MENU BUTTON and the MAIN MENU DISPLAY dialog box will appear.
3. Move the arrow by pressing the POINT BUTTON (UP/DOWN) to select the SCREEN. Press the REAR CLICK BUTTON and another dialog box, SCREEN ADJUST DISPLAY will appear. The current screen mode is displayed at the bottom right of the screen.
4. To switch the "WIDE" mode, move the arrow to the WIDE by pressing the POINT BUTTON (UP/DOWN) and press the REAR CLICK BUTTON.
5. To switch the "REGULAR" mode, move the arrow to the REGULAR by pressing the POINT BUTTON (UP/DOWN) and press the REAR CLICK BUTTON.
6. The "WIDE" settings is temporarily effective until you turn off the MAINS ON/OFF switch.
7. To quit the MENU, move the arrow to the QUIT and press the REAR CLICK BUTTON.

MAIN MENU DISPLAY



SCREEN ADJUST DISPLAY

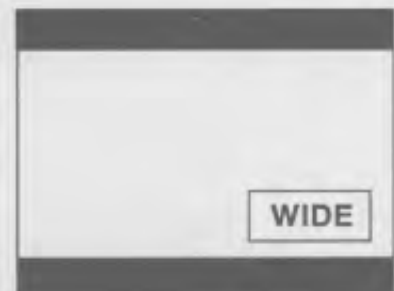
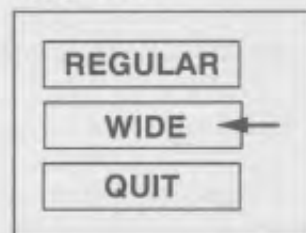

OTHER FUNCTION SETTING

This projector has other function settings; auto retract, reverse scan T/B, reverse scan L/R, blue back, display and PC adjustment.

AUTO RETRACT

When this function is in the "ON" position, the projector will retract the lens when the projector is turned off by the POWER (LAMP) ON/OFF button. To protect the lens from being damaged while you are carrying the set, you are strongly recommended to set this function "ON". Since the lens is pulled in each time the POWER is switched off, you need to make ZOOM and FOCUS adjustments when you turn on the projector.

REVERSE SCAN T/B

When this function is in the "BOTTOM" position, the top/bottom picture invert capability lets you project from a ceiling-mounted projector.

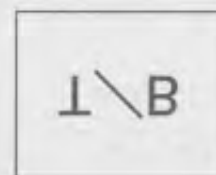

REVERSE SCAN L/R

When this function is in the "RIGHT" position, the left/right picture reverse capability lets you project onto a rear projection screen.

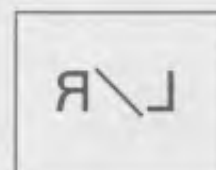

BLUE BACK

When this function is in the "ON" position, the projector will project the blue image without video noise on the screen when the video source is unplugged or turned off.

DISPLAY

When this function is in the "ON" position, on-screen displays always appear when adjustments are made. Although these on-screen displays are very helpful, these may spoil the view if adjustments are made during presentation. To avoid this, you can keep back certain displays by switching this function "OFF". The followings are the displays that you can hide.

- Wait Display
- Volume Display.
- Color System Display.
- Zoom and Focus Display (When remote control unit used).
- Normal Display

PC ADJUSTMENT

This is a special function that may be used when a computer image is not reproduced properly. This item appears only when the projector is in COMPUTER MODE and the MENU is activated by the REMOTE CONTROL UNIT. (See the page 37 ~ 38 for more detail.)

You can adjust these settings except PC ADJUSTMENT by either the REMOTE CONTROL UNIT or the TOP CONTROL of the projector. The ways are different from one another.

USE REMOTE CONTROL TRANSMITTER UNIT

1. Press the MENU BUTTON and the MAIN MENU DISPLAY dialog box will appear.
2. Move the arrow by pressing the POINT BUTTON (UP/DOWN) to select the SETTING. Press the REAR CLICK BUTTON and another dialog box, SETTING DISPLAY will appear.
3. Move the arrow to an item you want to switch and the current setting is displayed at the bottom right of the screen.
4. If you want to flip the setting, press the REAR CLICK BUTTON.
5. To quit the MENU, point to the QUIT and press the REAR CLICK BUTTON.
6. The settings are permanently held even if the MAINS ON/OFF is switched off.

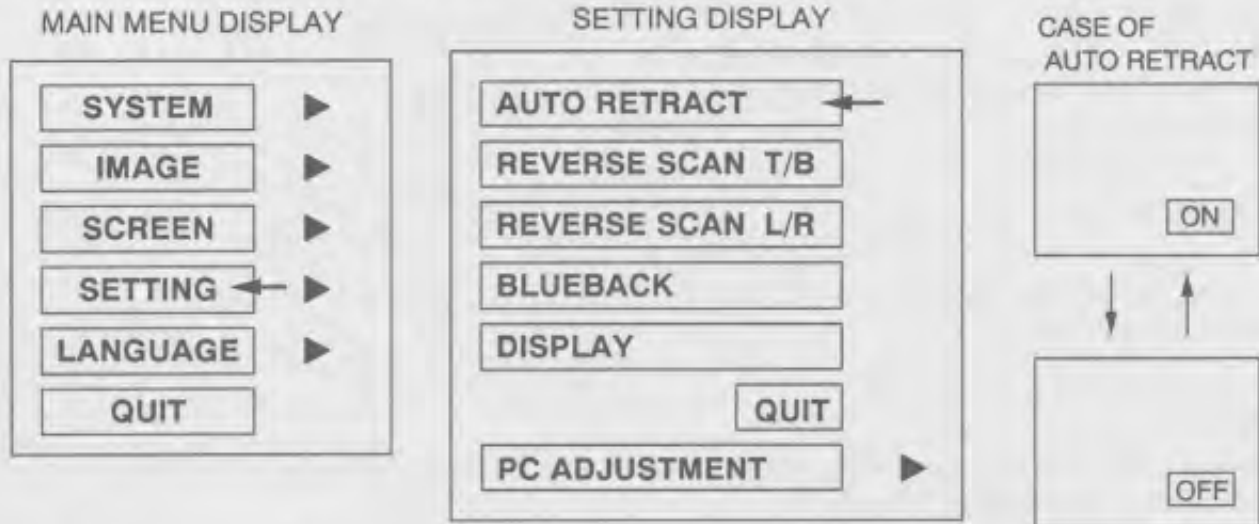

USE TOP CONTROL OF THE PROJECTOR

1. Press the SETTING BUTTON and the SETTING DISPLAY will appear.
2. Move the arrow to an item you want to switch by pressing the SETTING BUTTON. The arrow will cyclically move downwards one by one each time the SETTING BUTTON is pressed.
3. The current setting for the selected item is displayed at the bottom right of the screen.
4. The items and the alternatives that you can set are summarized in the table below.
5. To switch the setting, press the LEVEL (+) or (-) BUTTON.
6. To quit the MENU, point to the QUIT by pressing the SETTING BUTTON and press the LEVEL (+) BUTTON.

NOTE: The adjustments have been preset at the factory to the left column values (LEVEL + side) on this table.

FUNCTION	LEVEL (+)	LEVEL (-)
AUTO RETRACT	ON	OFF
REVERSE SCAN T/B	TOP	BOTTOM
REVERSE SCAN L/R	LEFT	RIGHT
BLUEBACK	ON	OFF
DISPLAY	ON	OFF

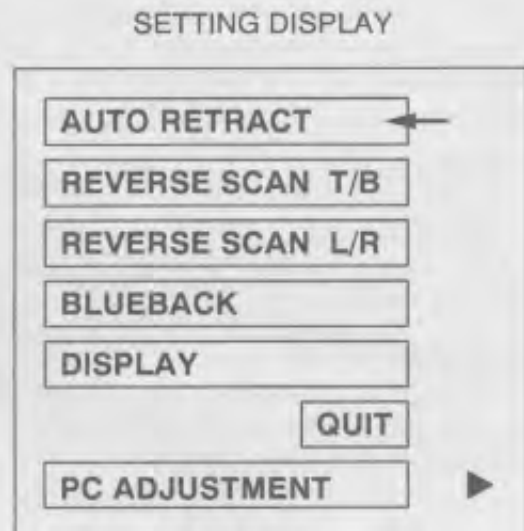

PC ADJUSTMENT

This projector can automatically discriminate most display signals in most personal computers currently distributed. However, some computers employ a special signal format which is different from the standard ones and may not be detected by this projector. If this happens, the projector cannot reproduce a proper image, often recognized as a flickering picture, a non-synchronized picture, a non-centered picture or a skewed picture.

To project a proper image for those non-standard formats, this projector provide PC ADJUSTMENT, in which you can precisely adjust several parameters to match the input signal format. The projector has eight independent memory areas that you can store the parameter settings you have made. Therefore, you can recall the setting for a specific computer when you need.

This adjustment is made by only the REMOTE CONTROL UNIT.

1. Press the MENU BUTTON and the MAIN MENU DISPLAY dialog box will appear.
2. Move the arrow by pressing the POINT BUTTON(UP/DOWN) to select the SETTING. Press the REAR CLICK BUTTON and another dialog box, SETTING DISPLAY will appear.
3. Then, move the arrow by pressing the POINT BUTTON(UP/DOWN) to select the PC ADJUSTMENT. Press the REAR CLICK BUTTON and another dialog box, "WHERE TO RESERVE" will appear.
4. In this dialog box, you will select one of the memory areas shown as "MODE1" to "MODE8". If the parameters have been previously set and stored to the memory, the status "STORED" will appear on a corresponding row. If not, "FREE" will appear.
5. Move the arrow to one of the "MODEs" that you want to modify or store by pressing the POINT BUTTON(UP/DOWN). Press the REAR CLICK BUTTON to select it.

MAIN MENU DISPLAY



SETTING DISPLAY

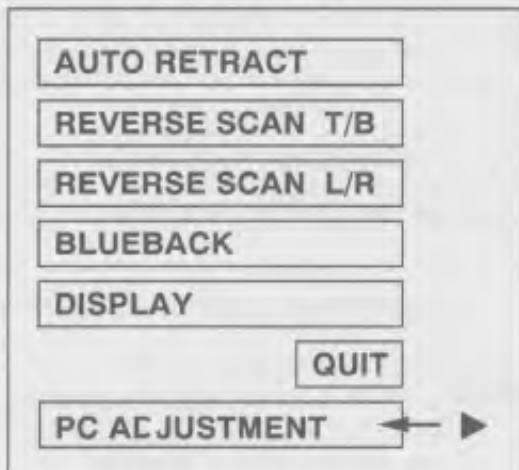

WHERE TO RESERVE

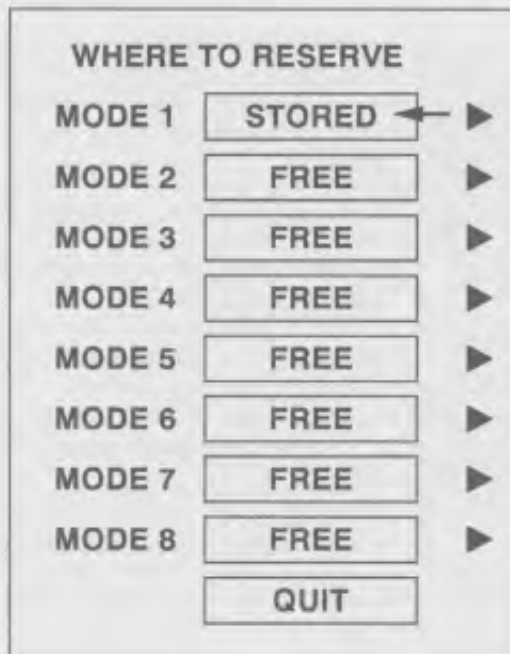

6. Another dialog box will appear and the parameter data for the MODE you have selected are shown in this dialog box.
7. The parameters will be filled with the data determined by the projector according to the present signal input.
8. The function of the parameters and their values are summarized in the table below.
9. For your reference, "PC CONFIGURATION" is also available. This will appear by the parameter dialog box, and show some characteristics of the display signal currently connected. These figures are measured by the projector. PC CONFIGURATION includes "TOTAL LINES, H-FREQUENCY and POLARITY".
10. Move the arrow to an item that you want to adjust by pressing the POINT BUTTON (UP/DOWN).
11. To increase the level, point the arrow to Δ and press the REAR CLICK BUTTON. To decrease the level, point the arrow to ∇ and press the REAR CLICK BUTTON.
12. If you want to store the settings to the memory, move the arrow to the MEMORY and press the REAR CLICK BUTTON. When you have stored the settings, you will see "OK !" as a confirmation. Press the REAR CLICK BUTTON then to quit.
13. Whenever you want to quit the MENU, point to the QUIT and press the REAR CLICK BUTTON.
14. If you quit the MENU without storing the settings to the memory, the parameter data will be kept as you stored them last time even if you have changed some values.
15. The stored settings are permanently held even if the MAINS ON/OFF is switched off.

PC CONFIGURATION	
TOTAL LINES	630
H-FREQUENCY	37.8
POLARITY	H+V+

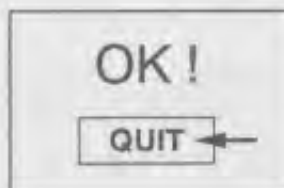

MODE 1 STORED	
TOTAL DOTS	1056 Δ ∇
TOTAL LINES	630 Δ ∇
MAC/XGA	OFF Δ ∇
H-CENTER	47 Δ ∇
V-CENTER	4 Δ ∇
CLAMP	300 Δ ∇
H-SHIFT	OFF Δ ∇
HEIGHT	1 Δ ∇
WIDTH	1 Δ ∇
V-WINDOW	0 Δ ∇
V-RAM SYNC	40 Δ ∇
	MEMORY
	QUIT

ITEM	FUNCTION
TOTAL DOTS	The number of the total dots in one horizontal period. Adjust the number to match your PC image.
TOTAL LINES	The number of the total vertical lines. Adjust the number to match your PC image.
MAC/XGA	Switch to match a MAC/XGA image signal. When MAC or XGA image is to be projected, turn this on.
H-CENTER	Adjustment of the horizontal picture position. When the image is not centered on the screen, adjust this.
V-CENTER	Adjustment of the vertical picture position. When the image is not centered on the screen, adjust this.
CLAMP	Adjustment of the clamp level. When the image has a dark bar, try this adjustment.
H-SHIFT	Coarse adjustment of the CLAMP position. To be adjusted in conjunction with CLAMP.
HEIGHT	Expanding or compressing level for the vertical direction.
WIDTH	Expanding or compressing level for the horizontal direction.
V-WINDOW	To be adjusted to lessen the skew noise.
V-RAM SYNC	To be adjusted to eliminate the VRAM noise generated by the partial scan.

LANGUAGE ADJUSTMENT

You can select a language used in the MENU among English, German, French, Italian and Spanish. This can be switched by only the REMOTE CONTROL UNIT.

1. Press the MENU BUTTON and the MAIN MENU DISPLAY dialog box will appear.
2. Move the arrow by pressing the POINT BUTTON (UP/DOWN) to select the LANGUAGE. Press the REAR CLICK BUTTON and another dialog box, LANGUAGE SETTING DISPLAY will appear.
3. Move the arrow to the language you want to use by pressing the POINT BUTTON (UP/DOWN) and press the REAR CLICK BUTTON.
4. To quit the MENU, move the arrow to the QUIT and press the REAR CLICK BUTTON.
5. The setting is permanently held even if the MAINS ON/OFF is switched off.

NOTE: The languages you can select are highlighted in LANGUAGE SETTING DISPLAY. Some projectors distributed in certain areas allow you to select *limited* languages.

MAIN MENU DISPLAY

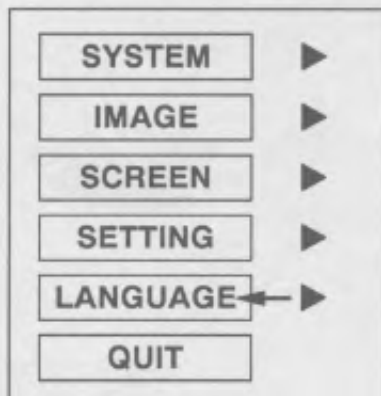

LANGUAGE SETTING DISPLAY

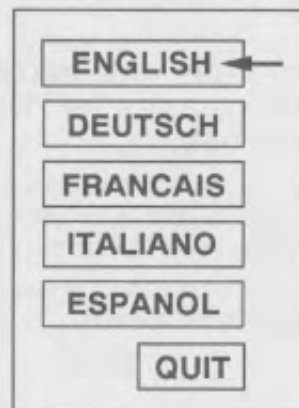

AIR FILTER CARE AND CLEANING

The removable air filter prevents dust from accumulating on the surface of the projection lens and projection mirror. Should the air filter become clogged with dust particles, it will reduce the cooling fan's effectiveness and may result in internal heat built up and reduce the life of the projector.

To clean the air filter, follow the cleaning procedures below:

1. Turn the POWER (LAMP) ON/OFF button OFF.
2. Remove the air filter cover.
Carefully place a coin against the indented part of the filter cover and lift.
3. Remove the air filter from the filter cover.
4. Clean the air filter with a vacuum cleaner.
5. Replace the air filter. Make sure that air filter cover is fully inserted.

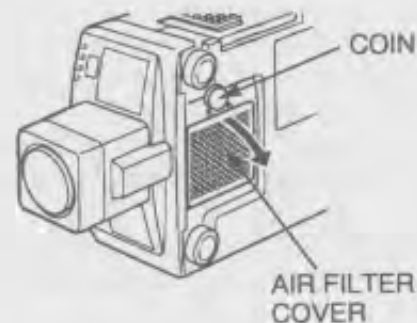

Do not clean with water. Doing so may damage the air filter.
Do not operate the projector with air filter removed.

RECOMMENDATION

TO ENJOY PICTURE IMAGE, USE THE PROJECTOR IN THE CLEAN ENVIRONMENT. USAGE IN THE CLEAN ENVIRONMENT IS RECOMMENDED.

When used under the dusty or smoky conditions, dust may accumulate on the liquid crystal panel and lens inside it, and may resultantly be projected on the screen together with the picture.

When the above symptoms are noticed contact the place where your authorized dealer or service station for the cleaning.

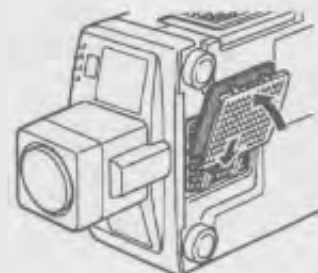

TEMPERATURE WARNING INDICATOR

The TEMPERATURE WARNING INDICATOR flashes red when the internal temperature of the projector exceeds the normal temperature.

Possible causes for the temperature warning may be:

1. Ventilation slots of the projector are blocked. In such an event, reposition the projector so that ventilation slots are not obstructed.
2. Air filter is clogged with dust particles. Remove dust from the air filter by following instructions in the Air Filter Care and Cleaning section above. If temperature warning indicator remains on after performing the checks listed above, cooling fan/internal circuits may be malfunctioning. Request service from an authorized dealer or service station.

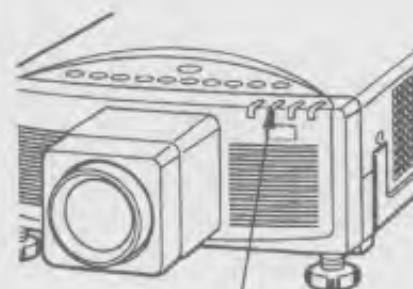

TEMPERATURE
WARNING
INDICATOR

LAMP REPLACEMENT

If the lamp fails to come on and the lamp monitor on the projector light is orange, you must replace the bulb.



- For continued safety, replace with a lamp assembly of the same type.
- Allow the projector to cool for at least 45 minutes before you open the lamp cover. The inside of the projector can become very hot.
- Do not drop the lamp module or touch the glass bulb ! The glass can shatter and cause injury.
- To prevent operator injury, the lamp cover is locked. Unless the guard is in the unlocked position, the lamp cover will not disconnect even if the screws have been removed.

Follow these steps to replace the lamp assembly.

1. Turn off the projector and allow the projector to cool thoroughly.
2. Disconnect the AC cord from the projector and slide the guard to the unlock position.
3. Remove 2 screws with a screwdriver and disconnect the lamp cover.
4. Remove 2 screws with a screwdriver and pull out the lamp assembly by grasping the handle.
5. Replace the lamp assembly.
6. Tighten 4 screws to secure the lamp cover to the lamp assembly.
7. Slide the guard, locking the lamp cover.
8. Connect the detachable AC cord to the projector.

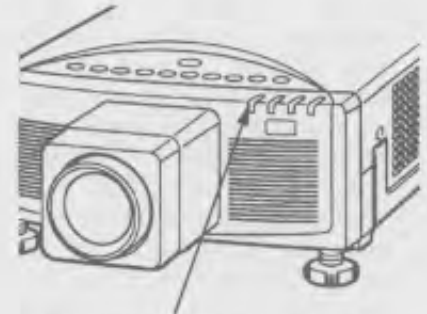

LAMP REPLACEMENT INDICATOR

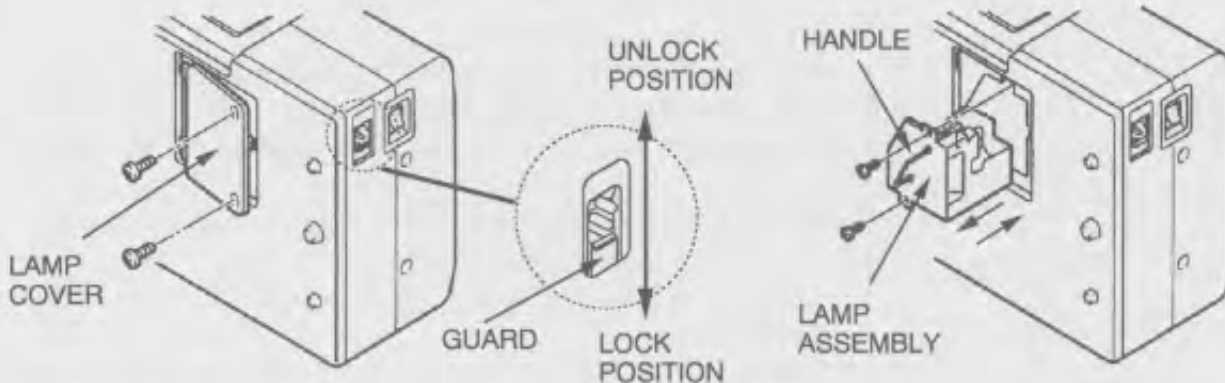

9. Reset the lamp replacement monitor timer.
 - (1). Plug the projector into an AC outlet and switch the power on.
 - (2). Wait for about 30 seconds until the wait display goes off.
 - (3). Press the Reset switch on the left side of the projector using the tip of a ball-point pen for two seconds.
 - (4). "RESET" will appear on the screen and go off after a few seconds. The timer is now reset.

NOTE: Do not press the RESET SWITCH, except after the lamp replacement.

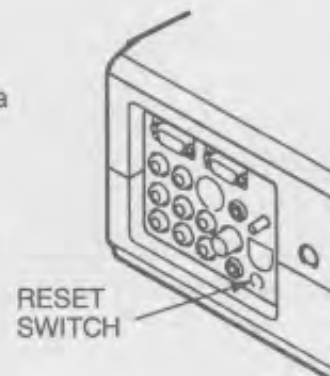

RESET SWITCH

RESET

CLEANING THE LENS

Follow these steps to clean the projection lens:

1. Apply a non-abrasive camera lens cleaner to a soft, dry cleaning cloth.
Avoid using an excessive amount of cleaner.
Abrasive cleaners, solvents or other harsh chemicals might scratch the lens.
2. Lightly wipe the cleaning cloth over the lens.
3. If you don't intend to use the projector immediately, replace the lens cover.

TROUBLESHOOTING

Before calling your dealer or service station for assistance, follow these steps in this order to make sure everything is properly connected.

1. Make sure you have connected the projector to your equipment as described in section "CONNECTING THE PROJECTOR" on page 10 - 17.
2. Check cable connections. Verify that all computer, video and power cord are properly connected.
3. Verify that all power is switched on.
4. If the projector still does not display an image, restart the computer.
5. If the image is still does not display, unplug the projector from the computer and check the computer monitor's display. The problem may be with your graphics controller rather than with the projector. (When you reconnect the projector, remember to turn the computer and monitor off before you power up the projector. Power the equipment back up in this order: Projector, monitor, computer)
6. If the problem still exists, check the following chart.

Problem:	Try these Solutions:
No power	<ul style="list-style-type: none"> ● Plug the projector into an AC outlet. ● Turn the MAINS ON/OFF button to ON. ● Press the POWER (LAMP) ON/OFF switch to ON. ● Check the READY INDICATOR light ON. ● One minute has not passed after the projector turned OFF. <p>NOTE: After pressing the POWER (LAMP) ON/OFF button to OFF, the projector functions as follows.</p> <ol style="list-style-type: none"> 1. The POWER indicator will light bright and READY indicator will turn off. 2. After one minute, the READY indicator will light green again and the projector may be turned on by pressing the POWER (LAMP) ON/OFF button. <ul style="list-style-type: none"> ● Check temperature warning indicator. (If flash red the indicator, the projector can not be turned on. (See "USING THE PROJECTOR" section on page 24). ● Check projection lamp.
Image is out of focus	<ul style="list-style-type: none"> ● Adjust the focus. ● Make sure the projection screen is at least 3.6 feet (1.1 m) from the projector. ● Check the projection lens to see if it needs cleaning. <p>NOTE: Moving the projector from a cool temperature location to a warm temperature location may result in moisture condensation on the lens. In such an event, leave the projector OFF and wait until condensation disappears.</p>

Problem:	Try these Solutions:
The lens is pulled in when the POWER is switched off.	Check AUTO RETRACT function. (See "OTHER FUNCTION SETTING" section on page 35).
Picture is L/R Reversed.	Check REVERSE SCAN L/R feature. (See "OTHER FUNCTION SETTING" section on page 35).
Picture is T/B inverted.	Check REVERSE SCAN T/B feature. (See "OTHER FUNCTION SETTING" section on page 35).
Some displays are not seen during the operation.	Check DISPLAY feature. (See "OTHER FUNCTION SETTING" section on page 35).
No sound.	<ul style="list-style-type: none"> ● Check audio cable connection from audio input source. ● Adjust audio source. ● Press the VOLUME (+) button. ● Press the Mute button.
Remote control unit doesn't work.	<ul style="list-style-type: none"> ● Check batteries. ● Make sure nothing is blocking the remote control unit on the projector. ● Make sure you are not too far from the projector when using the remote control unit. {Maximum operate range 16.4 feet (5 m)}.
Wireless mouse function does not work.	<ul style="list-style-type: none"> ● Check cable connection between the projector and the computer. ● Check the mouse setting of your computer. ● Turn on the projector before you turn on the computer.

TECHNICAL SPECIFICATIONS

SPECIFICATIONS

Projector Type	Multi-media Projector
Dimensions (H x W x D)	5.9" (148.9 mm) × 11.6" (296 mm) × 18.1" (459 mm)
Net Weight	16.5 lbs (7.5 kg)
LCD Panel System	1.3" TFT Active Matrix type (Thin Film Transistor) × 3
Number of Pixels	1,557,504 {519,168 (832 × 624) × 3}
Color System	4 color system (PAL, SECAM, NTSC and NTSC4.43)
Scanning Frequency	H-sync. 15 ~ 58 KHz, V-sync. 50 ~ 75 Hz
Projection Image Size (Diagonal)	Adjustable from 20" to 400"
Contrast Ratio	100 :1
Horizontal Resolution	750 TV lines
Projection Lens	f2.5 ~ 3.2 lens with 1.77" ~ 2.95" Motor zoom and focus
Throw Distance	3.6' (1.1 m) ~ 75.6' (23.0 m)
Projection Lamp	Metal Halide, 250 watt type
Projection Mirror	Dichroic mirror and X-prism system
AV Input jacks	RCA Type × 1 (Video, Audio R and L), BNC Type × 1 and DIN 4 pin (S-Video) × 1
Computer Input Jack	HDB15 Terminal × 1, Multi-pole 12 pin (Control port)
Monitor Output Jack	HDB15 Terminal × 1
Computer Audio Input Jack	RCA Type × 1 (R and L)
Video Monitor Output Jack	RCA Type × 1
Audio Monitor Output Jacks	RCA Type × 1 (R and L)
Other Jacks	EXT. Speaker Jack × 1, Microphone Jack × 1
Built-in Speaker	INT. SP. Stereo (R and L), 2 watt RMS (T.H.D. 10%)
Image Elevation Adjustment	Up 6°
Voltage	100 ~ 120V AC, 50/60 Hz
Power Consumption	5.0A (Max. Ampere)
Operating Temperature	5 °C ~ 35 °C
Storage Temperature	- 10 °C ~ 60 °C
Remote Control Battery	(2) AA Type



This symbol on the nameplate means the product is Listed by Underwriters Laboratories Inc. It is designed and manufactured to meet rigid U.L. safety standards against risk of fire, casualty and electrical hazards.

-MEMO-

EIKI

P/N: 6102637397

EIKI

Audio Visual/Video Products

EIKI INTERNATIONAL, INC.

26794 Vista Terrace Drive, Lake Forest, CA. 92630-8113
TEL (714) 457-0200 FAX (714) 457-7878

IN CANADA, EIKI CANADA
355 Cranston Crescent P.O. Box 156
Midland Ontario L4R 4K8 Canada
TEL (705) 527-4084 FAX (705) 527-4087

Printed in Japan
Part No. 610 263 7397 (1AA6P1P1014-- M6FB)

© 1996 Eiki International, Inc.

Free Manuals Download Website

<http://myh66.com>

<http://usermanuals.us>

<http://www.somanuals.com>

<http://www.4manuals.cc>

<http://www.manual-lib.com>

<http://www.404manual.com>

<http://www.luxmanual.com>

<http://aubethermostatmanual.com>

Golf course search by state

<http://golfingnear.com>

Email search by domain

<http://emailbydomain.com>

Auto manuals search

<http://auto.somanuals.com>

TV manuals search

<http://tv.somanuals.com>