

User's Manual

FlexScan[®] L362T

Touch Panel Color LCD Monitor

It shall be assured that the system finally complies with IEC60601-1-1 requirements.



SAFETY SYMBOLS

This manual uses the safety symbols below. They denote critical information. Please read them carefully.



WARNING

Failure to abide by the information in a WARNING may result in serious injury and can be life threatening.



CAUTION

Failure to abide by the information in a CAUTION may result in moderate injury and/or property or product damage.



Indicates a prohibited action.



Indicates to ground for safety.

Copyright© 2003 EIZO NANA O CORPORATION All rights reserved. No part of this manual may be reproduced, stored in a retrieval system, or transmitted, in any form or by any means, electronic, mechanical, or otherwise, without the prior written permission of EIZO NANA O CORPORATION.

EIZO NANA O CORPORATION is under no obligation to hold any submitted material or information confidential unless prior arrangements are made pursuant to EIZO NANA O CORPORATION's receipt of said information. Although every effort has been made to ensure that this manual provides up-to-date information, please note that EIZO monitor specifications are subject to change without notice.

ENERGY STAR is a U.S. registered mark.

VGA is a registered trademark of International Business Machines Corporation.

DPMS is a trademark and VESA is a registered trademark of Video Electronics Standards Association.

Windows is a registered trademark of Microsoft Corporation.

PowerManager is a trademark of EIZO NANA O COROPRATION.

ScreenManager, FlexScan and EIZO are registered trademarks of EIZO NANA O CORPORATION.



As an ENERGY STAR® Partner, EIZO NANA O CORPORATION has determined that this product meets the ENERGY STAR guidelines for energy efficiency.

TABLE OF CONTENTS

 PRECAUTIONS	4
1. INTRODUCTION	9
1-1. Features	9
1-2. Package Contents.....	9
1-3. Controls & Connectors	10
2. CABLE CONNECTION	12
2-1. Before connecting	12
2-2. Connecting the signal cable	13
2-3. Connecting two PCs to the monitor.....	15
2-4. Sound Connections	15
3. ScreenManager	16
3-1. How to use the ScreenManager	16
3-2. Adjustments and Settings	17
3-3. Useful Functions	18
4. ADJUSTMENT	20
4-1. Screen Adjustment	20
4-2. Color Adjustment	24
4-3. Power-save Setup	26
5. ATTACHING AN ARM	28
6. TROUBLESHOOTING	29
7. CLEANING	33
8. SPECIFICATIONS	34
9. GLOSSARY	37
APPENDIX/ANHANG/ANNEXE	i

PRECAUTIONS

IMPORTANT!



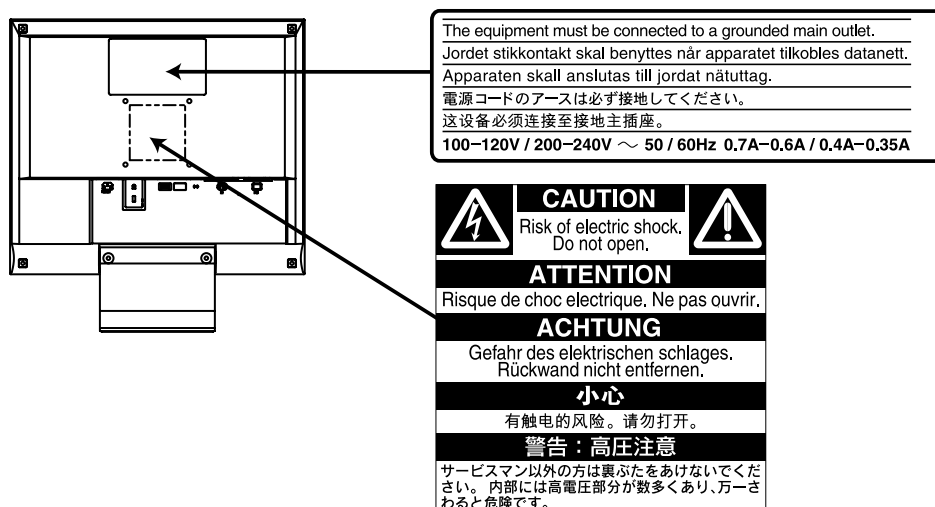

This product has been adjusted specifically for use in the region to which it was originally shipped. If operated outside the region to which it was originally shipped, the product may not perform as stated in the specifications.

To ensure personal safety and proper maintenance, please read this section and the caution statements on the unit (refer to the figure below).

[Location of the Caution Statements]



[Symbols on the unit]

Symbol	Location	This symbol indicates
	Front Control panel	Power button Press to turn the monitor's power on or off.
	Rear Name Plate	Alternating current
	Rear Name Plate	Alerting electrical hazard
	Rear Name Plate	Caution Refer to SAFETY SYMBOLS section in this manual.

WARNING

If the unit begins to emit smoke, smells like something is burning, or makes strange noises, disconnect all power connections immediately and contact your dealer for advice.

Attempting to use a malfunctioning unit can be dangerous.

Do not dismantle the cabinet or modify the unit.

Dismantling the cabinet or modifying the unit may result in electric shock or burn.



Refer all servicing to qualified service personnel.

Do not attempt to service this product yourself as opening or removing covers may expose you to dangerous voltage or other hazards.

Keep small objects or liquids away from the unit.

Small objects accidentally falling through the ventilation slots into the cabinet or spillage into the cabinet may result in fire, electric shock, or equipment damage.

If an object or liquid falls/spills into the cabinet, unplug the unit immediately. Have the unit checked by a qualified service engineer before using it again.

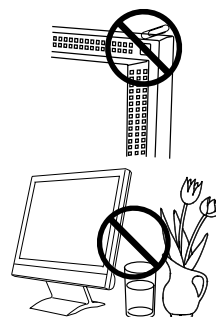

Place the unit on a strong, stable surface.

A unit placed on an inadequate surface may fall, resulting in injury or equipment damage.

When the unit is dropped, please ask your dealer for advice. Do not continue using a damaged unit. Using a damaged unit may result in fire or electric shock.



Set the unit in an appropriate location.

Not doing so may cause damage and could result in fire or electric shock.

- * Do not place outdoors.
- * Do not place in the transportation system (ship, aircraft, trains, automobiles, etc.)
- * Do not place in a dusty or humid environment.
- * Do not place in a location where the steam comes directly on the screen.
- * Do not place near heat generating devices or a humidifier.
- * Do not place in an inflammable gas environment.



WARNING

To avoid danger of suffocation, keep the plastic packing bags away from babies and children.

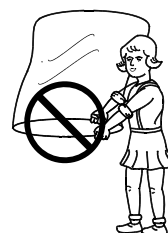

Use the enclosed power cord and connect to the standard power outlet of your country. Be sure to remain within the rated voltage of the power cord.

Not doing so may cause in fire or electric shock.

To disconnect the power cord, grasp the plug firmly and pull.

Never tug on the cord, doing so may cause damage and could result in fire or electric shock.



The equipment must be connected to a grounded main outlet.

Not doing so may cause in fire or electric shock.



Use the correct voltage.

- * Do not overload your power circuit, as this may result in fire or electric shock.
- * The unit is designed for use with a specific voltage only. Connection to another voltage than specified in this User's Manual may cause fire, electric shock, or other damage.
- * Do not overload your power circuit, as this may result in fire or electric shock.

Handle the power cord with care.

- * Do not place the cord underneath the unit or other heavy objects.
- * Do not pull on or tie the cord.

If the power cord becomes damaged, stop using it. Use of a damaged cord may result in fire or electric shock.



Never touch the plug and power cord if it begins to thunder.

Touching them may result in electric shock.

WARNING

When attaching an arm stand, please refer to the user's manual of the arm stand and install the unit securely with the enclosed screws.

Not doing so may cause the unit to come unattached, which may result in injury or equipment damage. When the unit is dropped, please ask your dealer for advice. Do not continue using a damaged unit. Using a damaged unit may result in fire or electric shock. When reattaching the tilt stand, please use the same screws and tighten them securely.

Do not touch a damaged LCD panel directly with bare hands.

The liquid crystal which leaks from the panel is poisonous if it enters the eyes or mouth.

If any part of the skin or body comes in direct contact with the panel, please wash thoroughly. If some physical symptoms result, please consult your doctor.

Follow local regulation or laws for safe disposal.

The backlight of the LCD panel contains mercury.

CAUTION

Handle with care when carrying the unit.

Disconnect the power cord and cables when moving the unit. Moving the unit with the cord attached is dangerous. It may result in injury or equipment damage.

When handling the unit, grip the bottom of the unit firmly with both hands ensuring the panel faces outward before lifting.

Dropping the unit may result in injury or equipment damage.

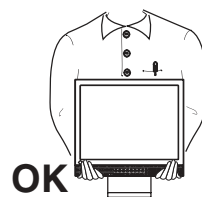

Do not block the ventilation slots on the cabinet.

- * Do not place books or any other papers on the ventilation slots.
- * Do not install the unit in a closed space.
- * Do not use the unit lying down or upside down.

Using the unit in these ways blocks the ventilation slots and prevents proper airflow, leading to fire or other damage.



CAUTION

Do not touch the plug with wet hands.

Touching them may result in electric shock.



Use an easily accessible power outlet.

This will ensure that you can disconnect the power quickly in case of a problem.

Periodically clean the area around the plug.

Buildup of dust, water, or oil on the plug may result in fire.

Unplug the unit before cleaning it.

Cleaning the unit while it is plugged into a power outlet may result in electric shock.

If you plan to leave the unit unused for an extended period, disconnect the power cord from the wall socket after turning off the power switch for the safety and the power conservation.

LCD Panel

In order to suppress the luminosity change by long-term use and to maintain the stable luminosity, use of a monitor in lower brightness is recommended.

The screen may have defective pixels. These pixels may appear as slightly light or dark area on the screen. This is due to the characteristics of the panel itself, and not the product.

The backlight of the LCD panel has a fixed life span. When the screen becomes dark or begins to flicker, please contact your dealer.

Do not scratch or press on the panel with any sharp objects, such as a pencil or pen as this may result in damage to the panel. Do not attempt to brush with tissues as this may scratch the panel.

1. INTRODUCTION

Thank you very much for choosing an EIZO Color Monitor.

1-1. Features

- ≠ Dual inputs compliant
- ≠ DVI (p.37) Digital input (TMDS (p.38)) compliant.
- ≠ Horizontal scanning frequency: Analog input 24 - 61 kHz
Digital input 31 - 49 kHz
- Vertical scanning frequency: Analog input 55 - 75 Hz
Digital input 59 - 61 Hz (VGA text: 70 Hz)
- Resolution: 0.8 M pixels (1024 dots x 768 lines)
- ≠ Auto Adjustment compliant
- ≠ Support to sRGB (p.38) standard
- ≠ Built-in speaker system
- ≠ Touch Panel provided

1-2. Package Contents

Please contact your local dealer for assistance if any of the listed items are missing or damaged.

- ≠ LCD Monitor
- ≠ Power Cord
- ≠ Signal Cable (MD-C87/100)
- ≠ Touch Panel Cable (FD-C38)
- ≠ Stereo mini-jack Cable
- ≠ User's Manual
- ≠ ScreenManager Quick Reference
- ≠ LIMITED WARRANTY
- ≠ Mounting Screws: M4 x 12 (mm) x 4 pcs
- ≠ CD-ROM for Touch Panel (Contents: Touch Panel Driver, User's Manual)

NOTE

- ≠ Please retain the packing materials for future transference.
- ≠ Regarding the installing the touch panel driver, please follow the instructions in the CD-ROM.

1-3. Controls & Connectors

Front

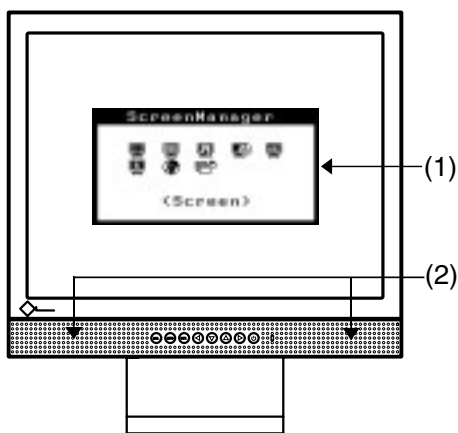

Control Panel

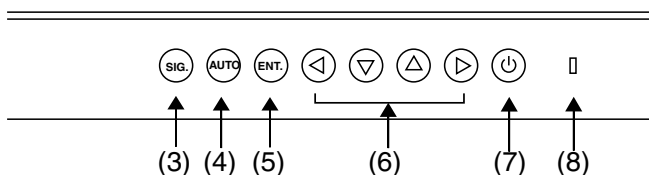

- (1) ScreenManager®
- (2) Speaker^{*1}

Volume Control	Press the Right and Left Buttons.
Mute	Press the Up or Down Button for a while after pressing the Right or Left Button to display the volume control bar. Press the Right or Left Button to mute off.

- (3) Input Signal Selection Button
- (4) Auto Adjustment Button
- (5) Enter Button
- (6) Control Buttons (Left, Down, Up, Right)
- (7) Power Switch
- (8) Power Indicator^{*2}

Blue	Operation
Yellow	Power saving
Flashing yellow (2 times for each)	Power save mode Digital only
Flashing yellow slowly	Power off

^{*1} Regarding the sound connection, see page 15.

^{*2} Regarding the power indicator for the off timer, see page 18.

Rear

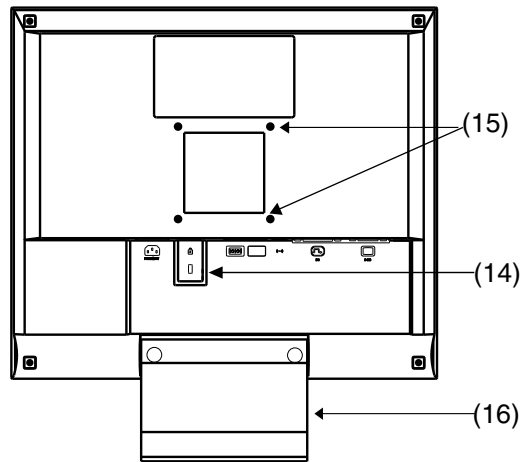

Bottom

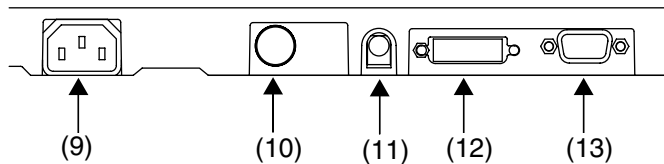

- (9) Power Connector
- (10) RS-232C port (Mini DIN 6 pin)
- (11) External line in (stereo mini-jack)
- (12) DVI-D Connector (SIGNAL 1)
- (13) D-Sub mini 15 pin Connector (SIGNAL 2)
- (14) Security Lock Slot^{*3}
- (15) 4 Holes for Mounting an Arm^{*4}
- (16) Stand (Detachable)^{*4}

^{*3} Allows for connection of a security cable. This lock supports Kensington's MicroSaver security system.

For further information, please consult:

Kensington Technology Group
 2855 Campus Drive, San Mateo, CA 94403 USA
 Tel: 800-650-4242, x3348
 Intl: 650-572-2700, x3348 / Fax: 650-572-9675
<http://www.kensington.com>

^{*4} The LCD monitor can be used with an optional arm stand by removing the stand (see page 28).

2. CABLE CONNECTION

2-1. Before connecting

Before connecting your monitor to the PC, change the display screen settings (resolution (p.37) and frequency) in accordance with the charts below.

NOTE

The lower display modes like 640x 480, automatically enlarge to the maximum display mode (1024 x 768), and some lines of the characters may become fuzzy. In this case, use <Smoothing> function (p.22) to make the lines clear.

When your computer and display support VESA DDC, the suitable resolution and the refresh rate are set by just plugging your display into the computer without any manual settings.

Analog Input

Resolution	Frequency	Dot Clock	Remarks
320 x 200	70 Hz	79 MHz (Max)	VGA
640 x 480	~75 Hz		VGA, VESA
720 x 400	70 Hz		VGA TEXT
800 x 600	~75 Hz		VESA
1024 x 768	~75 Hz		VESA

Digital Input

Resolution	Frequency	Dot Clock	Remarks
640 x 480	60 Hz	66 MHz (Max)	VGA
720 x 400	70 Hz		VGA TEXT
800 x 600	60 Hz		VESA
1024 x 768	60 Hz		VESA

2-2. Connecting the signal cable

NOTE

⚠ Be sure that the power switches of both the PC and the monitor are OFF.

1. Plug the signal cable into the connector at the rear of the monitor and the other end of the cable into the video connector on the PC.

After connecting, secure the connection with the screw-in fasteners.

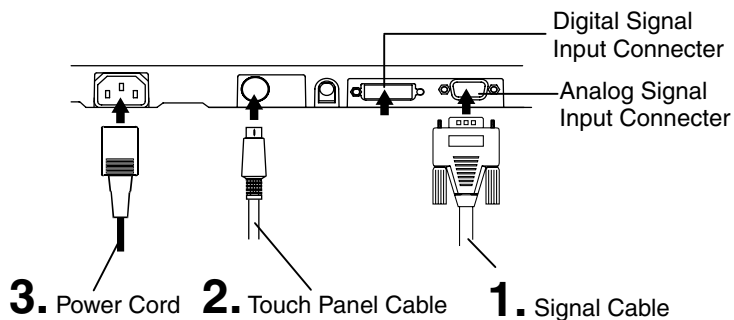

Analog Input

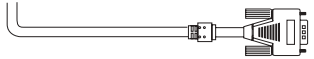
Signal Cable	Connector of PC	PC
Signal Cable (enclosed, MD-C87/100) 	Video Output Connector/ D-Sub mini 15 pin Input Connector (monitor)/ D-Sub mini 15 pin	⚠Standard graphics card

Digital Input

Signal Cable	Connector of PC	PC
FD-C39 (Optional) 	Video Output Connector DVI-I Input Connector (monitor)/ DVI	⚠Digital Graphics card

2. Plug the enclosed touch panel cable into the RS-232C port of the monitor. Then, plug the other end of the cable into the COM port of the computer.

NOTE

⚠ When using the monitor without the touch panel cable, please uninstall the touch panel driver from the computer. Not doing so may cause hang-up of the computer.

3. Plug the power cord into the power connector on the rear of the monitor. Then, plug the other end of the cord into a power outlet.

⚠ WARNING

Use the enclosed power cord and connect to the standard power outlet of your country.

Be sure to remain within the rated voltage of the power cord.
Not doing so may cause in fire or electric shock.

The equipment must be connected to a grounded main outlet.

Not doing so may cause in fire or electric shock.



4. Turn on the monitor's main power and then switch on the PC's power.

The monitor's power indicator will light up (blue).

If an image does not appear, refer to the "6. TROUBLESHOOTING" (p.29) for advice.

Whenever finished, turn off the PC and the monitor.

NOTE

- ⚠ Adjust brightness of the screen depending on the brightness of your environment. Too dark or too bright of a screen can cause eyestrain.
- ⚠ Be sure to take adequate rests. A 10-minute rest period each hour is suggested.

2-3. Connecting two PCs to the monitor

Two PCs can be connected to the monitor through the DVI and the D-Sub mini 15 pin connector on the back of the monitor.

Selecting the active input

The Input Signal Selection Button on the control panel can be used to select either Signal 1 or Signal 2 as the active input at any time. Every time the button is pressed, the input changes. When switching the signal, the kind of the input signal (Signal1 or 2/Analog or Digital) is displayed for a few seconds on the right top corner of the screen.

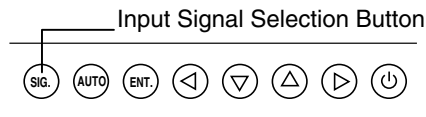

2-4. Sound Connections

NOTE

- ≠ Always switch the monitor and audio devices or computers off whenever connecting or disconnecting any audio devices (computer or CD player) to the monitor.
- ≠ Use the enclosed stereo mini-jack cable for connecting audio devices or computers to the monitor.

1. Connect the stereo mini-jack cable to the external line in of the monitor.
2. Connect the other side of stereo mini-jack cable to the line out of audio devices.

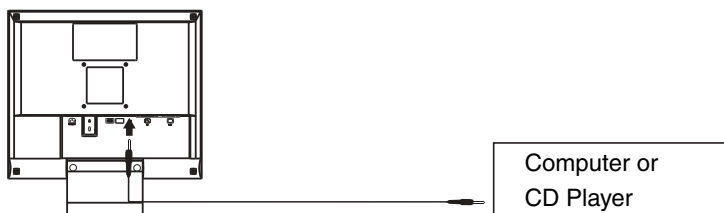

Volume control

Volume control	Press the Right and Left Buttons.
Mute	Press the Up or Down Button for a while after pressing the Right or Left Button to display the volume control bar.
Mute off	Press the Right or Left Button.

NOTE

- ≠ <Sound> menu of the ScreenManager also controls the sound.

3. ScreenManager

3-1. How to use the ScreenManager

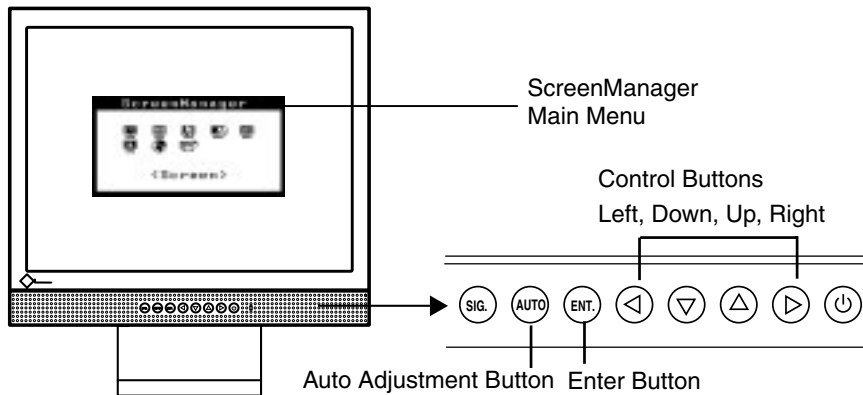

1. Entering the ScreenManager

Press the Enter Button once to display the main menu of the ScreenManager.

2. Making Adjustments and Settings

- (1) Select the desired sub menu icon using the Control Buttons and press the Enter Button. The sub menu appears.
- (2) Use the Control Buttons to select the desired setting icon and press the Enter Button. The setting menu appears.
- (3) Use the Control Buttons to make all required adjustments and press the Enter Button to save the settings.

3. Exiting the ScreenManager

- (1) To return to the main menu, select the <Return> icon or press the Down Button twice, followed by the Enter Button.
- (2) To exit the ScreenManager, select <Exit> icon or press the Down Button twice, followed by the Enter Button.

NOTE

Double clicking the Enter Button at any time also exits the ScreenManager menu.

3-2. Adjustments and Settings

The following table shows all the ScreenManager's adjustment and setting menus.
 “*” indicates adjustments of analog input only and “**” indicates digital input only.

Main menu	Sub menu	Reference
Screen	Clock	*
	Phase	*
	Position	*
	Range Adjustment	*
	Smoothing	
Color	Brightness	
	Color Mode	
	∅ Custom	
	Temperature	
	Gamma	
	Saturation	
	Hue	
	Gain	
	Reset	
∅ sRGB		
Sound	Volume	
	Mute	
PowerManager	DVI DMPM	**
	VESA DPMS	*
	Sound	
Others	Input Signal	
	Off Timer	
	VGA Selection	
	Menu Position	
	Translucent	
	Menu Off Timer	
	Reset	
Information	Information	
Language	English, German, French, Spanish, Italian and Swedish	

¹ Due to the inspection on the factory, the usage time may not “0 hour” at shipping.

3-3. Useful Functions

Adjustment Lock

Use the “Adjustment Lock” function to prevent any accidental changes.

Locked function	##Auto Adjustment Button adjustments and settings in the ScreenManager.
Unlocked function	##Adjustment of brightness by the Control Buttons. ##Sound control by the Control Buttons. ##Input Signal Selection Button

[To lock]

- (1) Switch off the monitor’s power by the power switch on the control panel.
- (2) Press on the Auto adjustment button while switching on the monitor’s power.

[To unlock]

- (1) Switch off the monitor’s power by the power switch on the control panel.
- (2) Hold down the Auto adjustment button once again and turn the power back on.

Off Timer

The off timer function causes the monitor to automatically enter a power off state after a predetermined amount of time has lapsed. This function was created to reduce afterimage (p.37) characteristics that are particular to LCD monitors when the monitor screen is left on for a long period without use.

[Procedure]

- (1) Select <Off Timer> in the ScreenManager <Others> menu.
- (2) Select “Enable” and press the Right and Left Buttons to adjust the “On Period” (1 to 23 hours).

[Off timer system]

PC	Monitor	Power Indicator
On Period (1H - 23H)	Operation	Blue
Last 15 min. in “On period”	Advance Notice ¹⁾	Blue Flashing
“On period” expired	Power off	Flashing yellow slowly

¹⁾ Advance notice (Power Indicator flashing blue) will be given 15 minutes before the monitor automatically enters the “Power Off” mode. To delay entering the “Power Off” mode, press the power switch during the advance notice period. The monitor will continue to operate for an additional 90 minutes.

[Power Resumption Procedure]

Press the power switch.

NOTE

The off timer function works while the PowerManager is active, but there is no advance notice before the monitor’s power is switched off.

EIZO Logo disappearing function

When switching on the Power Switch on the control panel, the EIZO logo is displayed for a while. If you desire to display or undisplay this logo, use this function. (Default is logo appearing.)

[To undisplay]

- (1) Switch off the monitor's power by the Power switch on the control panel.
- (2) Hold down the Enter button once again and turn the power back on.

[To display again]

- (1) Switch off the monitor's power by the Power switch.
- (2) Hold down the Enter button once again and turn the power back on.

Automatically selecting the input signal function

The monitor will automatically detect the inputted signal of either the connection for display.

Connecting two PCs to the monitor

When the one computer is switched off or entering the power saving mode, the monitor will automatically display the other signal.

Use the ScreenManager to switch the input selection to manual.

[Procedure]

- (1) Select <Input Signal> in the <Others> menu.
- (2) Select "Manual".

4. ADJUSTMENT

The monitor displays the digital input image correctly based on its pre-setting data. Adjust the brightness (p.23).

4-1. Screen Adjustment

Screen adjustments for the LCD monitor should be used in suppressing screen flickering and also for adjusting the screen to its proper position. There is only one correct position for each display mode. It is also recommended to use the ScreenManager function when first installing the display or whenever changing the system.

Adjustment Procedure

NOTE

⚠ Allow the LCD monitor to stabilize for at least 20 minutes before making image adjustments.

1. Press the Auto Adjustment Button on the control panel.

The message “Your setting will be lost, if you press again now.” appears and remains on the screen for 5 seconds. While the message is on the screen, press the Auto Adjustment Button again to automatically adjust the clock, phase, and screen position. If you do not wish to do adjust the screen, do not press the Auto Adjustment Button again.

NOTE

⚠ The Auto Adjustment function is intended for use on AT-compatible PC running Windows. It may not work properly in either of the following cases. When running an AT-compatible PC on MS-DOS (Not windows). The background color for the “wall paper” or “desktop” pattern is set to black.

If the appropriate screen can not be made by using the Auto Adjustment Button, adjust the screen through the following procedures. If the appropriate screen can be made, proceed to step 4.

2. We recommend setting the desktop pattern to that as shown in the diagram below.

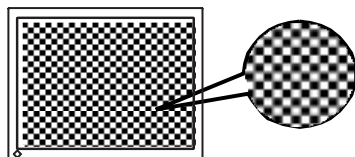

NOTE

≠ More precise adjustment is available for using the “Screen Adjustment program” utility software. It can be downloaded from the EIZO homepage (<http://www.eizo.com/>).

3. Adjust by using <Screen> menu in the ScreenManager.

- (1) Vertical bars appear on the screen

↓  Use the <Clock> (p.37) adjustment.

Select the <Clock> and eliminate the vertical bars by using the Right and Left of the Control Buttons.

Do not continuously press the Control Buttons, as the adjustment value will change quickly and make it difficult to locate the most suitable adjustment point. If the horizontal flickering, blur or bars appear, proceed to <Phase> adjustment as follows.

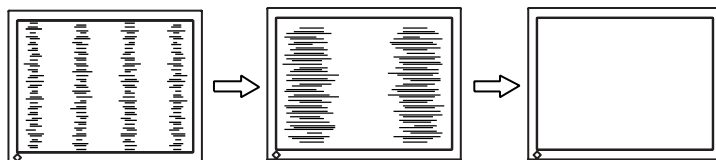

- (2) Horizontal bars appear on the screen.

↓  Use the <Phase> (p.38) adjustment.

Select the <Phase> and eliminate the horizontal flickering, blurring or bars by using the Right and Left Buttons.

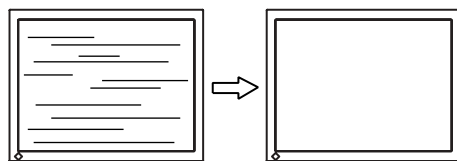

NOTE

≠ Horizontal bars may not completely disappear from the screen depending on the PC.

(3) The screen position is incorrect.

↓  Use the <Position> adjustment.

The correct displayed position of the monitor is decided because the number and the position of the pixels are fixed. The “Position” adjustment moves the image to the correct position.

Select <Position> and adjust the position by using the Up, Down, Right and Left Buttons.

If vertical bars of distortion appear after finishing the <Position> adjustment, return to <Clock> adjustment and repeat the previously explained adjustment procedure. Clock↓ Phase↓ Position

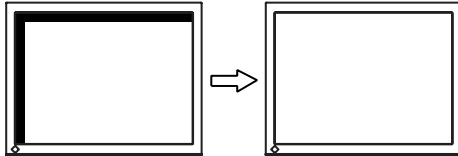

4. To adjust the output signal range (Dynamic Range) of the signal.

↓  Use the <Range Adjustment> (p.38) of <Screen> menu.

This controls the level of output signal range to display the whole color gradation (256 colors).

[Procedure]

Press the Auto Adjustment Button on the control panel while displaying the <Range Adjustment> menu to automatically adjust the range. The screen blanks for a moment, and adjusts the color range to display the whole color gradation of the current output signal.

5. To smooth the blurred texts of the enlarged screen of the lower resolutions.

↓  Switch the <Smoothing> setting.

<Smoothing> is clear-cut the letters or lines.

Select <Smoothing> in the screen menu and select the suitable level from 1 ~ 5.

NOTE

⚠ The “Smoothing” is disabled in the resolution 1024 x 768.

⚠ Since the displayed image is enlarged, the blurred texts may not be necessarily lost completely.

6. To Set the Brightness of the screen.

↓  Use the < Brightness > adjustment.

The brightness of the entire screen is controlled by changing the brightness of the backlight.

Select < Brightness > in the screen menu and adjust by using the Up and Down Buttons.

NOTE

⚠ Directly pressing the Up and Down Buttons also adjusts the brightness. Press the Enter Button to save and exit the settings after the adjustment.

4-2. Color Adjustment



The <Color> menu in the ScreenManager enables to change the color of the screen. By using the <Color Mode>, the adjustment mode can be selected from <Custom mode> (to adjust the color settings according to your preference) and <sRGB> mode.





In the analog input, perform the “Range Adjustment” (p.22) before making the color adjustments.

NOTE

- ⚠ Allow the LCD monitor to stabilize for at least 20 minutes before making image adjustments. (Allow the monitor to warm up for at least 20 minutes before making adjustments.)
- ⚠ Performing the <Reset> of the <Color> menu returns the color settings to the default settings
- ⚠ The values shown in percentages represent the current level within the specific adjustment. They are available only as a reference tool. (To create an uniform white or black screen, the percentages for each will probably not be the same.)

Adjustment Contents

Menu	Color Mode		Function Descriptions	Adjustable range
	Custom	sRGB		
Brightness 	.	.	To set the brightness of the screen	0 ∽ 100%
Temperature (p.37) 	.	-	To set the color temperature	4,000 ∽ 10,000 K in 500 K increments (including 9,300 K). Default setting is off (normal white)
NOTE ⚠The values shown in the Kelvin are available only as a reference tool. ⚠Setting the temperature under 4,000 K or over 10,000 K invalidates the color temperature setting. (The color temperature's setting turns "OFF".)				
Gamma (p.38) 	.	-	To set the gamma value	1.8 ∽ 2.6
NOTE ⚠If setting the gamma value, the using the monitor in the digital signal input is recommended. If using the monitor in the analog input signal, set the gamma value from 1.8 to 2.2.				

Menu	Color Mode		Function Descriptions	Adjustable range
	Custom	sRGB		
Saturation 	.	-	To change the saturation	-128 ∽ 127 Setting the minimum level (-128) turns the image to the monochrome.
			NOTE ∅#The <Saturation> adjustment may cause undisplayable color tone.	
Hue 	.	-	To change the flesh color, etc.	-32 ∽ 32
			NOTE ∅#The <Hue> adjustment may cause undisplayable color tone.	
Gain (p.37) 	.	-	To change each color (red, green and blue)	0 ∽ 100% By adjusting the red, green and blue color tones for each mode, custom colors can be defined. Display a white or gray background image and adjust the <Gain>.
			NOTE ∅#The values shown in the percentage are available only as a reference tool. ∅#Setting the <Temperature> (p.37) invalidates the <Gain> adjustment. <Gain> setting returns to the default.	
Reset 	.	-	To return the color settings to the default settings	Select the "Reset".

4-3. Power-save Setup

The <PowerManager> menu in the ScreenManager enables to set the power-save setup.

NOTE

⚠ Do your part to conserve energy, turn off the monitor when you are finished using it. Disconnecting the monitor from the power supply is recommended to save energy completely.

Analog Input

This monitor complies with the VESA DPMS (p.38).

[Procedure]

- (1) Set the PC's power saving settings.
- (2) Select "VESA DPMS" from the <PowerManager> menu.

[Power saving system]

PC		Monitor	Power Indicator
Operation		Operation	Blue
Power saving	STAND-BY SUSPEND OFF	Power saving	Yellow

Operate the mouse or keyboard to return to a normal screen.

Digital Input

This monitor complies with the DVI DMPM (p.37).

[Procedure]

- (1) Set the PC's power saving settings.
- (2) Select "DVI DMPM" from the < PowerManager > menu.

[Power saving system]

PC		Monitor	Power Indicator
Operation		Operation	Blue
Power saving		Power saving	Yellow
Off mode		Power saving ¹	Flashing yellow (2 times for each)

¹ Power saving through the PC's off mode is only supported when "Manual" is selected on the ScreenManager's <Input Signal>.

Operate the mouse or keyboard to return to a normal screen from the Power save mode of the PC.

Power on the PC to return a normal screen from the Off mode of the PC.

Power save for speaker

When the monitor is in the power-saving mode, sound of speaker also erases simultaneously can be performed.

[Procedure]

- (1) Set the PC's power saving settings.
- (2) Select <Sound>.
- (3) Select "Disable". ("Enable" is selected to leave sound.)

5. ATTACHING AN ARM

The LCD monitor can be used with an arm by removing the tilt stand and attaching the arm or stand to the LCD monitor.

Using our optional arm or stand is recommended. (Ask your local dealer for information.)

NOTE

If you will use the arm or stand of other manufacturers, confirm the followings to the manufacturers before selecting.

- Hole spacing on the arm mounting: 75 mm x 75 mm (VESA compliant)
- Supportable Weight: Total weight of the monitor (without stand) and attaching equipment such as a cable
- TÜV/GS approved arm or stand

Please connect cables after attaching an arm stand.

Setup Procedure

1. Lay the LCD monitor down. Do not scratch the panel.
2. Remove the tilt stand by loosening the screws (2 pcs of M4 x 10 mm).
3. Attach an arm stand to the LCD monitor securely.

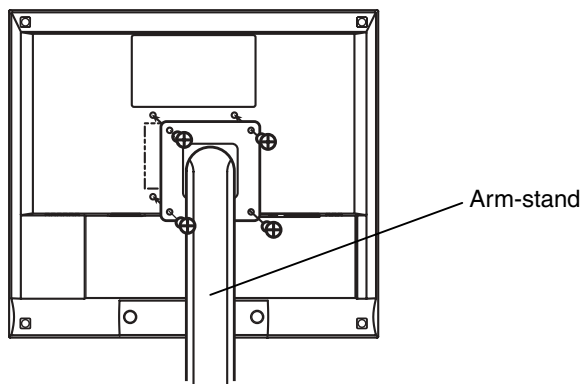

4 Mounting Screws (enclosed): M4 x 12 mm

6. TROUBLESHOOTING

If a problem persists even after applying the suggested remedies, contact an EIZO dealer.



No picture problems : See No.1 ~ No.2

Imaging problems : See No.3 ~ No.9

Other problems : See No.10 ~ No.13

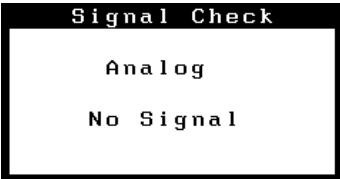
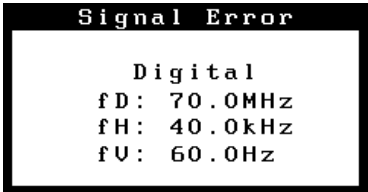
Touch Panel Problems: See No. 14 ~ No.17

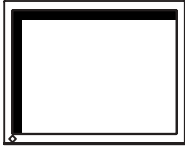
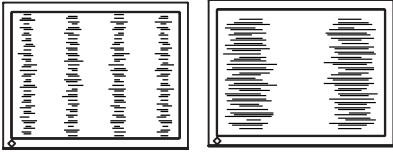
Problems	Points to check with possible solutions
1. No picture ##Indicator status: Off	Y Check that the power cord is correctly connected. If the problem persists, turn off the monitor power for a few minutes, then turn it back on and try again.
##Indicator status: Blue ##Indicator status: Yellow ##Indicator status: Flashing Yellow (twice for each)	Y Check the "Brightness" setting. Y Switch the signal input by pressing the Input Signal Selection Button on the front control panel. Y Try pressing a key on the keyboard, or clicking the mouse. (p.26) Y Try pressing the power of the computer.
2. Following messages appear. (Error messages shown below will remain on the screen for 40 seconds.) 	These message appear when the signal is not inputted correctly, even if the monitor functions properly. Y When the image is displayed correctly after a short time, there is no problem with the monitor. (Some PCs do not output the signal soon after powering on.) Y Check that the PC is turned ON. Y Check that the signal cable is properly connected to the PC or graphics board. Y Switch the signal input by pressing the Input Signal Selection Button on the front control panel.
##Whenever an error signal message appears, the signal frequency will be displayed in red. 	Y Use the graphics board's utility software to change the frequency setting. (Refer to the manual of the graphics board.)

Problems	Points to check with possible solutions
<p>3. Display position is incorrect.</p> 	<p>ÿ Adjust the image position using the <Position> (p.22)</p> <p>ÿ The two display modes, VGA 720 x 400 (70 Hz) and 320 x 200 (70 Hz), have the same signal timings. Using this adjustment selects the appropriate display mode. (This function effects only when the resolution is VGA 720 x 400 (70 Hz) or 320 x 200 (70 Hz).</p> <p>ÿ If the problem persists, use the graphics board's utility software to change the display position if available.</p>
<p>4. Vertical bars of distortion appear.</p> 	<p>ÿ Decrease the vertical bars using the <Clock>. (p.21)</p>
<p>5. Horizontal bars of distortion appear.</p> 	<p>ÿ Decrease the horizontal bars using the <Phase>. (p.21)</p>
<p>6. Letters and lines appear blurred.</p>	<p>ÿ Switch the <Smoothing> mode. (p.22)</p>
<p>7. The screen is too bright or too dark.</p>	<p>ÿ Adjust the <Contrast and brightness> (The baklight of the LCD monitor has a fixed life span. When the screen becomes dark or begins to flicker, please consult your dealer.)</p>
<p>8. Afterimages appear.</p>	<p>ÿ When the screen image is changed after displaying the same image for a long period, an afterimage may appear. The "Afterimage" can be removed gradually by changing the displayed image. Use the "Off Timer" function and avoid keeping the screen on all the time. (p.18)</p>
<p>9. The screen has defective pixels (e.g. slightly light or dark).</p>	<p>ÿ This is due to the characteristics of the panel itself, and not the LCD product.</p>

Problems	Points to check with possible solutions
10. The <Smoothing> cannot be selected.	ÿ <Smoothing> is disabled when the screen is displayed in the 1024 x768.
11. The Enter Button does not operate.	ÿ The adjustment lock is probably on. To unlock: switch the LCD monitor off. Then, while pressing the Auto Adjustment Button switch, the power on. (p.18)
12. The Auto Adjustment Button does not operate.	<p>ÿ The adjustment lock is probably on. To unlock: switch the LCD monitor off. Then, while pressing the Auto Adjustment Button switch, the power on. (p.18)</p> <p>ÿ The Auto sizing function is intended for use on the AT-compatible PC running Windows. It may not work properly in either of the following cases.</p> <ul style="list-style-type: none"> • When running an AT-compatible PC on MS-DOS (Not windows). • The background color for the “wall paper” or “desktop” pattern is set to black. <p>ÿ Some signals from a graphics board may not function properly.</p>
13. The signal Selection Button does not operate.	ÿ The computer with digital may be in the off mode (power indicator flashing yellow). Try to press the monitor’s power switch and press the Input Signal Selection Button again.

€# Touch Panel problems

Problems	Points to check with possible solutions
14. Cursor is jittery. / Drawing lines are not straight and smooth.	<ul style="list-style-type: none"> ÿ Locate the monitor where no influence of the metal. ÿ Run the Stabilize Cursor option from the TouchWare (Touch Panel driver).
15. Cursor position is not correct. / Cursor jumps.	<ul style="list-style-type: none"> ÿ The drawing touch for a long time may cause cursor jump or incorrect cursor position. ÿ Keep metals away from the panel surface. ÿ Point and touch with one finger only. Keep other fingers away from the touch screen. Do not rest the hand in the monitor or bezel while touching the screen. ÿ Do not touch the screen while the computer is starting. Touch the screen after disappearing TouchWare starting window. ÿ The spray for preventing static electricity may influences the sensibility of the touch panel. Do not use it on cleaning.
16. Cursor does not work.	<ul style="list-style-type: none"> ÿ Do not keep touching a point for more than 15 seconds.
17. Computer is hang-up when using the monitor without touch panel.	<ul style="list-style-type: none"> ÿ When using the monitor without touch panel cable, please uninstall the touch panel driver from the computer.

7. CLEANING

Periodic cleaning is recommended to keep the monitor looking new and to prolong its operation lifetime.

NOTE

- ⚠ Never use thinner, benzene, ethanol, abrasive cleaners, or other strong solvents, as these may cause damage to the cabinet or panel.
- ⚠ Never use spray for preventing static electricity, as it may influence the sensibility of the touch panel.

Cabinet

To remove stains, wipe the cabinet with a soft, lightly moistened cloth using a mild detergent. Do not spray wax or cleaner directly into the cabinet. (For details, refer to the manual of the PC.)

Panel

- ⚠ The Panel surface can be cleaned with a soft cloth, such as cotton or lens paper.
- ⚠ If necessary, stubborn stains can be removed by moistening part of a cloth with water or isopropyl alcohol to enhance its cleaning power.

8. SPECIFICATIONS

LCD Panel	38 cm (15.0 inch), TFT color LCD panel with Anti-Glare Hard Coating, Viewing Angle: H: 170° V: 170° Response Time: approx. 55 ms	
Dot Pitch	0.297 mm	
Horizontal Scan Frequency	Analog: 24 ~ 61 kHz (Automatic) Digital: 31 ~ 49 kHz	
Vertical Scan Frequency	Analog: 55 ~ 75 Hz (Automatic) Digital: 59 ~ 61 Hz, (VGA Text : 70Hz)	
Resolution	0.8 M pixels (1024 dots x 768 lines)	
Dot Clock (Max.)	Analog: 79 MHz Digital: 66 MHz	
Display Colors	16 million colors (max.)	
Display Area	304.1 mm (H) x 228.1 mm (V) (11.9" (H) x 8.9" (V)) (Viewable image size: 381 mm (15.0"))	
Touch Panel	OS	Microsoft Windows 2000/XP (Not compatible with MacOS)
	Communication protocol	RS-232C serial
	Detective method	Analog capacitive digitizer technology, finger touch
Power Supply	100-120/200-240 VAC ±10%, 50/60 Hz, 0.7-0.6 A/0.4-0.35 A	
Power Consumption	Max.: 40 W (with speaker) Power Saving Mode: Less than 3 W	
Input Connector	D-Sub mini 15 pin, DVI-D	
Analog Input Signal (Sync)	Separate, TTL, Positive/Negative	
Analog Input Signal (Video)	0.7Vp-p/75T Positive	
Input Signal (Digital)	TMDS (Single Link)	
Signal registration	Analog: 45 (Factory preset: 12)	
Plug & Play	VESA DDC 2B	
Amplifier Output (max.)	1 W + 1 W	
Line input	Input impedance 11 kT (min.) Input sensitivity: 500 mV	
Dimensions	346 mm (W) x 369 mm (H) x 157 mm (D) (13.4"(W) x 14.5"(H) x 6.2"(D))	
Dimensions (without stand)	346 mm (W) x 301 mm (H) x 54.5 mm (D) (13.4"(W) x 11.6"(H) x 1.9"(D))	
Weight	5.0 kg (11.2 lbs.)	
Weight (without stand)	4.1 kg (9.0 lbs.)	

Environment conditions	Temperature	Operating: 0 °C ~ 35 °C (32 °F ~ 95 °F) Storage: -20 °C ~ 60 °C (-4 °F ~ 140 °F)
	Humidity	30% to 80% R.H. Non-condensing
	Pressure	860 to 1,060 hPa
Certifications and Standards 100-120 VAC 200-240 VAC		CB, NRTL/C-TÜV, FCC-B, EPA ENERGY STAR Program, CE(93/42/EEC), CB, TÜV Rheinland/GM, EPA ENERGY STAR Program
Classification of Equipment		Type of protection against electric shock: Class I EMC class: EN60601-1-2 2001 Group1 Class B Classification of medical device (MDD 93/42/EEC): Class I

Default settings

	Analog input	Digital input
Brightness	100%	
Smoothing	3	
Temperature	Off (Normal white)	
PowerManager	VESA DPMS	DVI DMPM
Input Signal	Auto	
Off Timer	Disable	
Language	English	

Dimensions

Unit mm (inches)

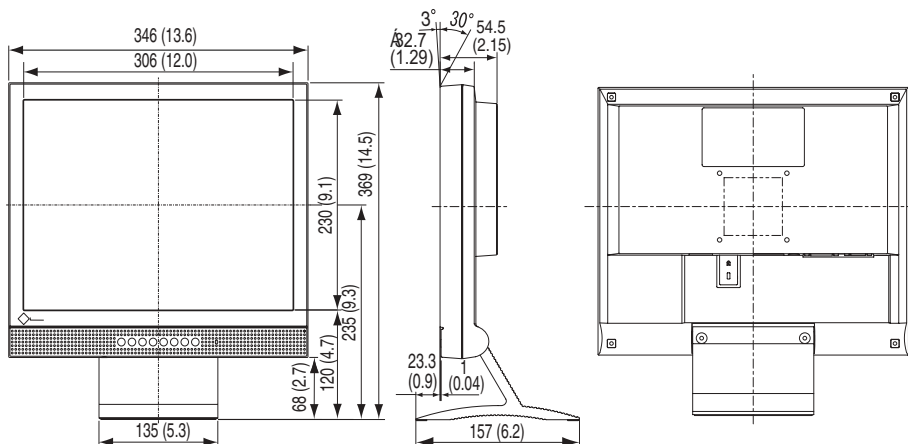

Pin Assignment

D-Sub mini 15 pin connector

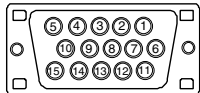

Pin No.	Signal	Pin No.	Signal	Pin No.	Signal
1	Red video	6	Red ground	11	Ground Shorted
2	Green video	7	Green ground	12	Data (SDA)
3	Blue video	8	Blue ground	13	H. Sync
4	Ground	9	No pin	14	V. Sync
5	No pin	10	Ground Shorted	15	Clock (SCL)

DVI-D Connector

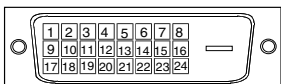

Pin No.	Signal	Pin No.	Signal	Pin No.	Signal
1	TMDS Data2-	9	TMDS Data1-	17	TMDS Data0-
2	TMDS Data2+	10	TMDS Data1+	18	TMDS Data0+
3	TMDS Data2/4 Shield	11	TMDS Data1/3 Shield	19	TMDS Data0/5 Shield
4	NC*	12	NC	20	NC
5	NC	13	NC	21	NC
6	DDC Clock (SCL)	14	+5V Power	22	TMDS Clock shield
7	DDC Data (SDA)	15	Ground (For +5V)	23	TMDS Clock+
8	Analog Vertical Sync	16	Hot Plug Detect	24	TMDS Clock-

(*NC: No Connection)

RS-232C Port (Mini DIN 6 pin)



Pin No.	Signal
1	NC*
2	NC
3	TXD
4	RXD
5	NC
6	GND

(*NC: No Connection)

9. GLOSSARY

Afterimage

The Afterimage is particular to LCD monitors when the monitor screen is left on for a long period without use. The “Afterimage” can be removed gradually by changing the displayed image.

Clock

With the analog input signal display, the analog signal is converted to a digital signal by the LCD circuitry. To convert the signal correctly, the LCD monitor needs to produce the same number clock pulse as the dot clock of the graphics system. When the clock pulse is not correctly set, some vertical bars of distortion are displayed on the screen.

Color Temperature (Temperature)

Color Temperature is a method to measure the white color tone, generally indicated in degrees Kelvin. At high temperatures the white tone appears somewhat blue, while at lower temperatures it appears somewhat red. Computer monitors generally give best performance at high temperature settings.

5,000 K: Slightly reddish white.

6,500 K: Warm-white tone, similar to white paper or daylight.

9,300 K: Slightly bluish white.

DVI

(Digital Visual Interface)

A digital flat panel interface. DVI can transmit digital data from the PC directly without loss with the signal transition method “TMDS”.

There are two kinds of DVI connectors. One is DVI-D connector for digital signal input only. The other is DVI-I connector for both digital and analog signal inputs.

DVI DMPM

(DVI Digital Monitor Power Management)

The Power management system for the digital interface. The “Monitor ON” status (operation mode) and the “Active Off” status (power-saving mode) are indispensable for the DVI-DMPM as the monitor’s power mode.

Gain Adjustment

Adjusts each color parameter for red, green and blue. The color of the LCD monitor is displayed through the color filter of the LCD panel. Red, green and blue are the three primary colors. The colors on the monitor are displayed by combining these three colors. The color tone can change by adjusting the illumination amount passed through each color’s filter.

Gamma

Generally, the relationship that the light intensity values of a monitor change nonlinearly to the input signal level is called “Gamma Characteristic”. On the monitor, low gamma values display the whitish images and high gamma values display the high contrast images.

Phase

The phase adjustment decides the sampling timing point for converting the analog input signal to a digital signal. Adjusting the phase after the clock adjustment will produce a clear screen.

Range Adjustment

The Range Adjustment controls the level of output signal range to display the whole color gradation.

Resolution

The LCD panel consists of a fixed number of pixel elements which are illuminated to form the screen image. The EIZO L362T display panel consists of 1024 horizontal pixels and 768 vertical pixels. At a resolution of 1024 x768, all pixels are displayed as a full screen.

sRGB (Standard RGB)

“International Standard for Red, Green, and Blue color space”

A color space was defined with the aim of the color matching between applications and hardware devices, such as monitors, scanners, printers and digital cameras. As a standard default space, sRGB allows Internet users to closely match colors.

TMDS

(Transition Minimized Differential Signaling)

A signal transition method for the digital interface.

VESA DPMS

(Video Electronics Standards Association - Display Power Management Signaling)

The acronym VESA stands for “Video Electronics Standards Association”, and DPMS stands for “Display Power Management Signaling.”DPMS is a communication standard that PCs and graphics boards use to implement power savings on the monitor side.

APPENDIX/ANHANG/ANNEXE

Preset Timing Chart for Analog input Timing-Übersichten für Analog Eingang Synchronisation des Signaux pour Analog numerique

Based on the signal diagram shown below 12 factory presets have been registered in the monitor's microprocessor.

Der integrierte Mikroprozessor des Monitors unterstützt 12 werkseitige Standardeinstellungen (siehe hierzu die nachfolgenden Diagramme).

12 signaux ont été enregistrés en usine dans le microprocesseur du moniteur, conformément au diagramme de synchronisation ci-dessous.

Mode	Dot Clock MHz	Sync Polarity		Frequencies	
		H	V	H kHz	V Hz
VGA Mode13 320 × 200	25.2	Nega.	Nega.	31.47	59.94
VGA 640 × 480	25.2	Nega.	Nega.	31.47	59.94
VGA 720 × 400	28.3	Nega.	Posi.	31.47	70.09
VESA 640 × 480	31.5	Nega.	Nega.	37.86	72.81
VESA 640 × 480	31.5	Nega.	Nega.	37.50	75.00
VESA 800 × 600	36.0	Posi.	Posi.	35.16	56.25
VESA 800 × 600	40.0	Posi.	Posi.	37.88	60.32
VESA 800 × 600	50.0	Posi.	Posi.	48.08	72.19
VESA 800 × 600	49.5	Posi.	Posi.	46.88	75.00
VESA 1024 × 768	65.0	Nega.	Nega.	48.36	60.00
VESA 1024 × 768	75.0	Nega.	Nega.	56.48	70.07
VESA 1024 × 768	78.8	Posi.	Posi.	60.02	75.03

For U.S.A, Canada, etc. (rated 100-120 Vac) Only

FCC Declaration of Conformity

We, the Responsible Party EIZO NANAOTECHNOLOGIES INC.
5710 Warland Drive, Cypress, CA 90630
Phone: (562) 431-5011

declare that the product Trade name: EIZO
Model: FlexScan L362T

is in conformity with Part 15 of the FCC Rules. Operation of this product is subject to the following two conditions: (1) this device may not cause harmful interference, and (2) this device must accept any interference received, including interference that may cause undesired operation.

This equipment has been tested and found to comply with the limits for a Class B digital device, pursuant to Part 15 of the FCC Rules. These limits are designed to provide reasonable protection against harmful interference in a residential installation. This equipment generates, uses, and can radiate radio frequency energy and, if not installed and used in accordance with the instructions, may cause harmful interference to radio communications. However, there is no guarantee that interference will not occur in a particular installation. If this equipment does cause harmful interference to radio or television reception, which can be determined by turning the equipment off and on, the user is encouraged to try to correct the interference by one or more of the following measures.

- * Reorient or relocate the receiving antenna.
- * Increase the separation between the equipment and receiver.
- * Connect the equipment into an outlet on a circuit different from that to which the receiver is connected.
- * Consult the dealer or an experienced radio/TV technician for help.

Changes or modifications not expressly approved by the party responsible for compliance could void the user's authority to operate the equipment.

Note

Use the attached specified cable below or EIZO signal cable with this monitor so as to keep interference within the limits of a Class B digital device.

- AC Cord
- Shielded Signal Cable
- Stereo mini-jack cable

Canadian Notice

This Class B digital apparatus complies with Canadian ICES-003.
Cet appareil numérique de la classe B est conforme à la norme NMB-003 du Canada.

Recycle Auskunft

Die Rücknahme dieses Produktes nach Nutzungsende übernimmt EIZO in Deutschland zusammen mit dem Partner von Roll MBB Recycling GmbH. Dort werden die Geräte in ihre Bestandteile zerlegt, die dann der Wiederverwertung zugeführt werden. Um einen Abholtermin zu vereinbaren und die aktuellen Kosten zu erfahren, benutzen Sie bitte folgende Rufnummer: 02153-73 35 00. Weitere Informationen finden Sie auch unter der Internet-Adresse: www.eizo.de.

Recycling Information for customers in Switzerland:

All recycling information is placed in the SWICO's website.
<http://www.swico.ch>

Recycling-Information für Kunden in der Schweiz:

Alle Informationen zum Thema Recycling finden Sie auf der Homepage des Branchenverbandes SWICO.

<http://www.swico.ch>

Renseignements de recyclage pour les clients en Suisse:

Vous trouvez tous les renseignements pour le sujet de recyclage sur la page WEB de l'UNION DE BRAN CHE SWICO.

<http://www.eizo.com/cotact/index.html>

Recycling Information for customers in USA:

All recycling information is placed in the EIZO Nanao Technologies, Inc's website.
<http://www.eizo.com/contact/index.html>

Återvinnings information för kunder i Sverige:

All information om återvinning finns på Eizo Nordics hemsida:
www.eizo.se

Free Manuals Download Website

<http://myh66.com>

<http://usermanuals.us>

<http://www.somanuals.com>

<http://www.4manuals.cc>

<http://www.manual-lib.com>

<http://www.404manual.com>

<http://www.luxmanual.com>

<http://aubethermostatmanual.com>

Golf course search by state

<http://golfingnear.com>

Email search by domain

<http://emailbydomain.com>

Auto manuals search

<http://auto.somanuals.com>

TV manuals search

<http://tv.somanuals.com>