

User's Manual

FlexScan® L565

Color LCD Monitor



SAFETY SYMBOLS

This manual uses the safety symbols below. They denote critical information. Please read them carefully.



WARNING

Failure to abide by the information in a WARNING may result in serious injury and can be life threatening.



CAUTION

Failure to abide by the information in a CAUTION may result in moderate injury and/or property or product damage.



Indicates a prohibited action.



Indicates to ground for safety.

Copyright© 2002 by EIZO NANAO CORPORATION. All rights reserved. No part of this manual may be reproduced, stored in a retrieval system, or transmitted, in any form or by any means, electronic, mechanical, or otherwise, without the prior written permission of Eizo Nanao Corporation.

Eizo Nanao Corporation is under no obligation to hold any submitted material or information confidential unless prior arrangements are made pursuant to Eizo Nanao Corporation's receipt of said information. Although every effort has been made to ensure that this manual provides up-to-date information, please note that EIZO monitor specifications are subject to change without notice.

ENERGY STAR is a U.S. registered mark.

Apple and Macintosh are registered trademarks of Apple Computer, Inc.

VGA is a registered trademark of International Business Machines Corporation.

DPMS is a trademark and VESA is a registered trademark of Video Electronics Standards Association.

Windows is a registered trademark of Microsoft Corporation.

ScreenManager and PowerManager are trademarks of Eizo Nanao Corporation.

FlexScan and EIZO are registered trademarks of Eizo Nanao Corporation.



As an ENERGY STAR® Partner, Eizo Nanao Corporation has determined that this product meets the ENERGY STAR guidelines for energy efficiency.

TABLE OF CONTENTS

 PRECAUTIONS	4
1. INTRODUCTION	9
1-1. Features	9
1-2. Package Contents.....	9
1-3. Controls & Connectors	10
2. CABLE CONNECTION	12
2-1. Before connecting	12
2-2. Connecting the signal cable	13
2-3. Sound Connections	15
3. ScreenManager	16
3-1. How to use the ScreenManager	16
3-2. Adjustments and Settings.....	17
3-3. Useful Functions	18
4. ADJUSTMENT	20
4-1. Screen Adjustment	20
4-2. Color Adjustment	24
4-3. Power-save Setup	25
5. ATTACHING AN ARM STAND	27
6. TROUBLESHOOTING	28
7. CLEANING	31
8. SPECIFICATIONS	32
9. GLOSSARY	34
APPENDIX/ANHANG/ANNEXE	i

PRECAUTIONS

IMPORTANT!

- This product has been adjusted specifically for use in the region to which it was originally shipped. If operated outside the region to which it was originally shipped, the product may not perform as stated in the specifications.
- To ensure personal safety and proper maintenance, please read this section and the caution statements on the unit (refer to the figure below).

[Location of the Caution Statements]

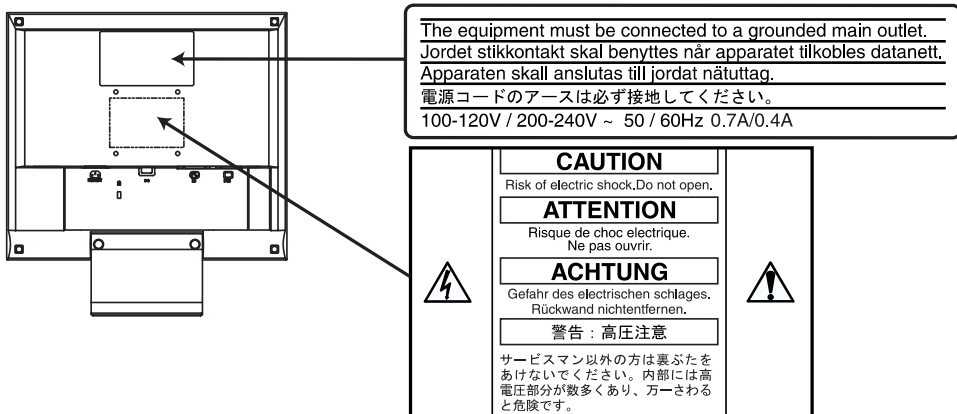

WARNING

If the unit begins to emit smoke, smells like something is burning, or makes strange noises, disconnect all power connections immediately and contact your dealer for advice.

Attempting to use a malfunctioning unit can be dangerous.

Do not dismantle the cabinet or modify the unit.

Dismantling the cabinet or modifying the unit may result in electric shock or burn.



Refer all servicing to qualified service personnel.

Do not attempt to service this product yourself as opening or removing covers may expose you to dangerous voltage or other hazards.

WARNING

Keep small objects or liquids away from the unit.

Small objects accidentally falling through the ventilation slots into the cabinet or spillage into the cabinet may result in fire, electric shock, or equipment damage.

If an object or liquid falls/spills into the cabinet, unplug the unit immediately. Have the unit checked by a qualified service engineer before using it again.

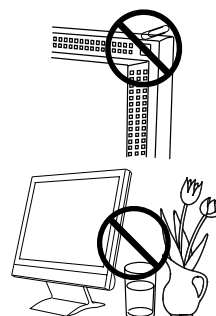

Place the unit on a strong, stable surface.

A unit placed on an inadequate surface may fall, resulting in injury or equipment damage.

When the unit is dropped, please ask your dealer for advice. Do not continue using a damaged unit. Using a damaged unit may result in fire or electric shock.



Set the unit in an appropriate location.

Not doing so may cause damage and could result in fire or electric shock.

- * Do not place in outdoors.
- * Do not place in the transportation system (ship, aircraft, trains, automobiles, etc.)
- * Do not install in a dusty or humid environment.
- * Do not place in a location where the steam comes directly on the screen.
- * Do not place near heat generating devices or a humidifier.



To avoid danger of suffocation, keep the plastic packing bags away from babies and children.



Use the enclosed power cord and connect to the standard power outlet of your country. Be sure to remain within the rated voltage of the power cord.

Not doing so may cause in fire or electric shock.

To disconnect the power cord, grasp the plug firmly and pull.

Never tug on the cord, doing so may cause damage and could result in fire or electric shock.



WARNING

The equipment must be connected to a grounded main outlet.

Not doing so may cause in fire or electric shock.



Use the correct voltage.

- * Do not overload your power circuit, as this may result in fire or electric shock.
- * The unit is designed for use with a specific voltage only. Connection to another voltage than specified in this User's Manual may cause fire, electric shock, or other damage.
- * Do not overload your power circuit, as this may result in fire or electric shock.

Handle the power cord with care.

- * Do not place the cord underneath the unit or other heavy objects.
- * Do not pull on or tie the cord.

If the power cord becomes damaged, stop using it. Use of a damaged cord may result in fire or electric shock.



Never touch the plug and power cord if it begins to thunder.

Touching them may result in electric shock.

When attaching an arm stand, please refer to the user's manual of the arm stand and install the unit securely with the enclosed screws.

Not doing so may cause the unit to come unattached, which may result in injury or equipment damage. When the unit is dropped, please ask your dealer for advice. Do not continue using a damaged unit. Using a damaged unit may result in fire or electric shock. When reattaching the tilt stand, please use the same screws and tighten them securely.

Do not touch a damaged LCD panel directly with bare hands.

The liquid crystal which leaks from the panel is poisonous if it enters the eyes or mouth.

If any part of the skin or body comes in direct contact with the panel, please wash thoroughly. If some physical symptoms result, please consult your doctor.

Follow local regulation or laws for safe disposal.

The backlight of the LCD panel contains mercury.

CAUTION

Handle with care when carrying the unit.

Disconnect the power cord and cables when moving the unit. Moving the unit with the cord attached is dangerous. It may result in injury or equipment damage.

When handling the unit, grip the bottom of the unit firmly with both hands ensuring the panel faces outward before lifting.

Dropping the unit may result in injury or equipment damage.

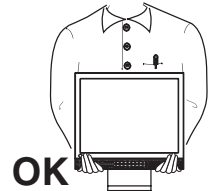

Do not block the ventilation slots on the cabinet.

- * Do not place books or any other papers on the ventilation slots.
- * Do not install the unit in a closed space.
- * Do not use the unit lying down or upside down.

Using the unit in these ways blocks the ventilation slots and prevents proper airflow, leading to fire or other damage.



Do not touch the plug with wet hands.

Touching them may result in electric shock.



Use an easily accessible power outlet.

This will ensure that you can disconnect the power quickly in case of a problem.

Periodically clean the area around the plug.

Buildup of dust, water, or oil on the plug may result in fire.

Unplug the unit before cleaning it.

Cleaning the unit while it is plugged into a power outlet may result in electric shock.

If you plan to leave the unit unused for an extended period, disconnect the power cord from the wall socket after turning off the power switch for the safety and the power conservation.

LCD Panel

The screen may have defective pixels. These pixels may appear as slightly light or dark area on the screen. This is due to the characteristics of the panel itself, and not the product.

The backlight of the LCD panel has a fixed life span. When the screen becomes dark or begins to flicker, please contact your dealer.

Do not press on the panel or edge of the frame strongly, as this will result in damage to the screen. There will be prints left on the screen if the pressed image is dark or black. If pressure is repeatedly applied to the screen, it may deteriorate or damage your LCD panel. Leave the screen white to decrease the prints.

Do not scratch or press on the panel with any sharp objects, such as a pencil or pen as this may result in damage to the panel. Do not attempt to brush with tissues as this may scratch the LCD panel.

1. INTRODUCTION

Thank you very much for choosing an EIZO Color Monitor.

1-1. Features

- Dual inputs compliant
- DVI (p.34) Digital input (TMDS (p.35)) compliant.
- Horizontal scanning frequency: 24.8 - 80 kHz (Digital input: 31.5 - 64 kHz)
Vertical scanning frequency: 55 - 75 Hz Vertical (Digital: 60 Hz (VGA text: 70 Hz))
Resolution: 1280 dots x 1024 lines
- Auto Adjustment compliant
- ColorManagement function incorporated
- Support to sRGB (p.35) standard
- Built-in speaker system

1-2. Package Contents

Please contact your local dealer for assistance if any of the listed items are missing or damaged.

- LCD Monitor
- Power Cord (1)
- Signal cable (MD-C87 or MD-C100) (1)
- Stereo mini-jack cable (1)
- User's Manual
- ScreenManager Quick Reference
- LIMITED WARRANTY
- Mounting Screws: M4 x 12 (mm) (4)

NOTE

- Please retain the packing materials for future transference.

1-3. Controls & Connectors

Front

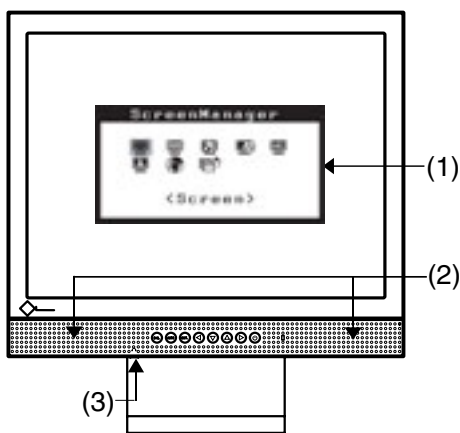

Control Panel

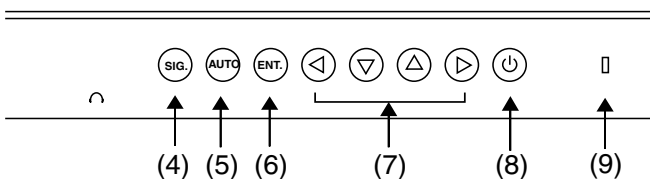

- (1) ScreenManager™
- (2) Speaker¹

Volume Control	Press the right and left buttons.
Mute	Press the up or down button for a while after pressing the right or left button to display the volume control bar. Press the right or left button to mute off.

- (3) Headphone jack (stereo mini-jack)
- (4) Input signal selection button
- (5) Auto Adjustment Button
- (6) Enter Button
- (7) Control Buttons (Up, Down, Left, Right)
- (8) Power Button
- (9) Power Indicator²

Blue	Operation
Yellow	Power saving
Flashing yellow (2 times for each)	Power save mode Digital only
Off	Power off

¹ Regarding the sound connection, see page 15.

² Regarding the power indicator for the “Off Timer”, see page 18.

Rear

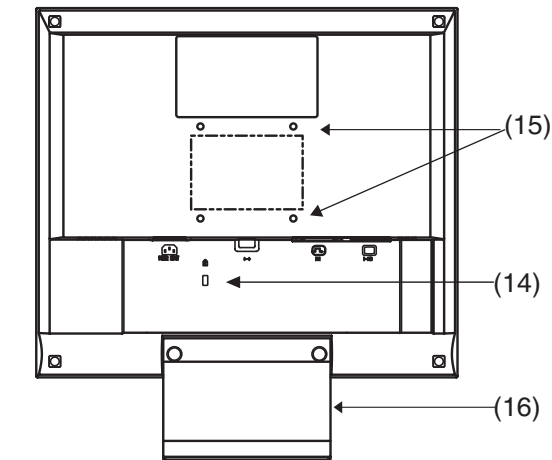

Bottom

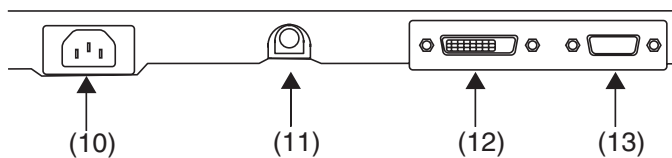

- (10) Power Connector
- (11) External line in (stereo mini-jack)
- (12) DVI-D Input Connector (Signal 1)
- (13) D-Sub mini 15 pin Input Connector (Signal 2)
- (14) Security Lock Slot^{*3}
- (15) 4 Holes for Mounting an Arm-Stand^{*4}
- (16) Stand (Detachable)^{*4}

^{*3} Allows for connection of a security cable. This lock supports Kensington's MicroSaver security system.

For further information, please consult:

Kensington Technology Group
 2855 Campus Drive, San Mateo, CA 94403 USA
 Tel: 800-650-4242, x3348
 Intl: 650-572-2700, x3348 / Fax: 650-572-9675
<http://www.kensington.com>

^{*4} The LCD monitor can be used with an optional arm stand by removing the stand (see page 27).

2. CABLE CONNECTION

2-1. Before connecting

Before connecting your monitor to the PC, change the display screen settings (resolution (p.34) and frequency) in accordance with the charts below.

NOTE

- The lower display modes like 640x 480, automatically enlarge to the maximum display mode (1280 x 1024), and some lines of the characters may become fuzzy. In this case, use <Smoothing> function (p.22) to make the lines clear.
- When your computer and display support VESA DDC, the suitable resolution and the refresh rate are set by just plugging your display into the computer without any manual settings.

Analog Input

Resolution	Frequency	Remarks
640 x 480	~75 Hz	VGA, VESA
720 x 400	70 Hz	VGA TEXT
800 x 600	~75 Hz	VESA
832 x 624	75 Hz	Apple Macintosh
1024 x 768	~75 Hz	VESA
1152 x 864	75 Hz	VESA
1152 x 870	75 Hz	Apple Macintosh
1280 x 960	60 Hz	VESA
1280 x 960	75 Hz	Apple Macintosh
1280 x 1024	~75 Hz	VESA

Digital Input

Resolution	Frequency	Remarks
640 x 480	60 Hz	VGA
720 x 400	70 Hz	VGA TEXT
800 x 600	60 Hz	VESA
1024 x 768	60 Hz	VESA
1280 x 1024	60 Hz	VESA

2-2. Connecting the signal cable

NOTE

- Be sure that the power switches of both the PC and the monitor are OFF.

1. Plug the signal cable into the connector at the rear of the monitor and the other end of the cable into the video connector on the PC.

After connecting, secure the connection with the screw-in fasteners.

Analog Input

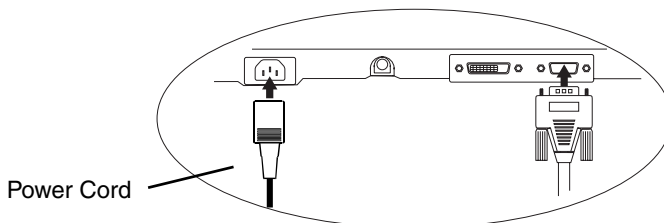

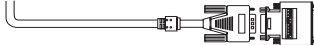
Signal Cable	Connector	PC
Signal Cable (enclosed) 	Video Output Connector D-Sub mini 15 pin	<ul style="list-style-type: none"> • Standard graphics card • Macintosh G3 (Blue & White) / G4
Signal Cable (enclosed) + Macintosh Adapter (Optional) 	Video Output Connector D-Sub 15 pin	<ul style="list-style-type: none"> • Macintosh

Digital Input

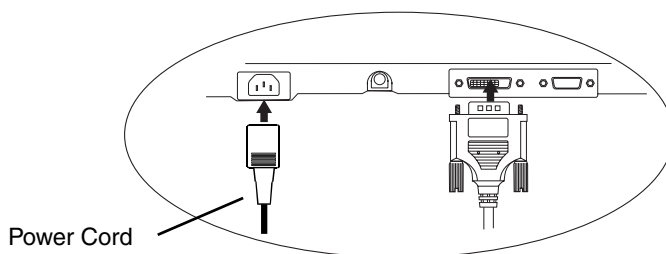

Signal Cable	Connector	PC
FD-C04 (Optional) 	Video Output Connector DVI	Digital Graphics card

NOTE

- The L565 is not compatible with a Power Macintosh G4/G4 Cube ADC (Apple Display Connector).

2. Plug the power cord into the power connector on the rear of the monitor. Then, plug the other end of the cord into a power outlet.

 **WARNING**

Use the enclosed power cord and connect to the standard power outlet of your country.

Be sure to remain within the rated voltage of the power cord.

Not doing so may cause in fire or electric shock.

The equipment must be connected to a grounded main outlet.

Not doing so may cause in fire or electric shock.



3. Turn on the monitor's main power and then switch on the PC's power.

The monitor's power indicator will light up (blue).

If an image does not appear, refer to the "6. TROUBLESHOOTING" (p.28) for advice.

Whenever finished, turn off the PC and the monitor.

NOTE

- Adjust brightness of the screen depending on the brightness of your environment. Too dark or too bright of a screen can cause eyestrain.
- Be sure to take adequate rests. A 10-minute rest period each hour is suggested.

2-3. Sound Connections

NOTE

- Always switch the monitor and audio devices or computers off whenever connecting or disconnecting any audio devices (computer or CD player) to the monitor.
- Use the enclosed stereo mini-jack cable for connecting audio devices or computers to the monitor.

1. Connect the stereo mini-jack cable to the external line in of the monitor.
2. Connect the other side of stereo mini-jack cable to the line out of audio devices.

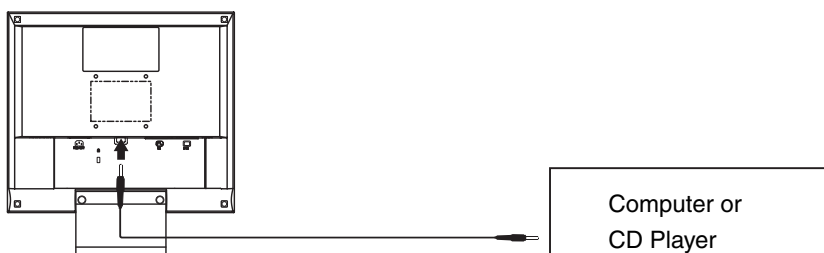

Sound control

Audio performance is available by connecting the headphone to the Headphone jack (When headphones are connected, no sound can be heard from the speakers).

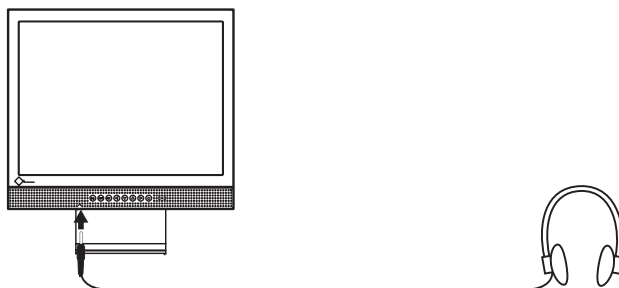

Volume control

Volume control	Press the right and left buttons.
Mute	Press the up or down button for a while after pressing the right or left button to display the volume control bar.
Mute off	Press the right or left button.

NOTE

- <Sound> menu of the ScreenManager also controls the sound.

3. ScreenManager

3-1. How to use the ScreenManager

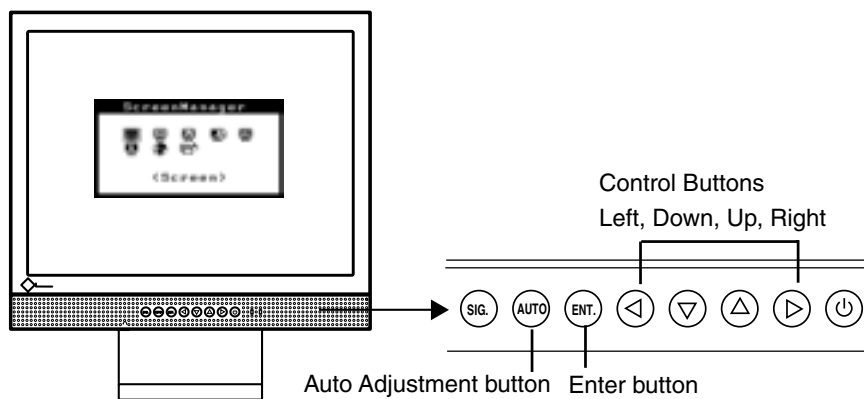

1. Entering the ScreenManager

Push the Enter button once to display the main menu of the ScreenManager.

[Main Menu]



2. Making Adjustments and Settings

- (1) Select the desired sub menu icon using the Control buttons and push the Enter button. The sub menu appears.
- (2) Use the Control buttons to select the desired setting icon and push the Enter button. The setting menu appears.
- (3) Use the Control buttons to make all required adjustments and push the Enter button to save the settings.

3. Exiting the ScreenManager

- (1) To return to the main menu, select the <Return> icon or push the down button twice, followed by the Enter button.
- (2) To exit the ScreenManager, select <Exit> icon or push the down button twice, followed by the Enter button.

NOTE

- Double clicking the Enter button at any time also exits the ScreenManager menu.

3-2. Adjustments and Settings

The following table shows all the ScreenManager's adjustment and setting menus.

“*” indicates adjustments of analog input only and “**” indicates digital input only.

Main menu	Sub menu	Reference
Screen	Clock	*
	Phase	*
	Position	*
	Smoothing	
	Contrast /Brightness	
ColorManagement	Range Adjustment	*
	Color Mode	
	• Custom	
	Temperature	
	Saturation	
	Hue	
	Gain	
	Reset	
Sound	Volume	
	Mute	
PowerManager	DVI DMPM	**
	VESA DPMS	*
	Sound	
Others	Input Signal	
	Off Timer	
	VGA Selection	
	Menu Position	
	Translucent	
	Menu Off Timer	
	Reset	
Information	Information	
Language	English, German, French, Spanish, Italian, Swedish and Japanese	

^{*1} Due to the inspection on the factory, the usage time may not “0 hour” at shipping.

3-3. Useful Functions

Adjustment Lock

Use the “Adjustment Lock” function to prevent any accidental changes.

Locked function	<ul style="list-style-type: none"> • Auto adjustment button adjustments and settings in the ScreenManager.
Unlocked function	<ul style="list-style-type: none"> • Adjustment of contrast and brightness by the control buttons. • Sound control by the control buttons. • Input signal selection button

- To lock

Switch off the monitor’s power by the power switch. Press on the Auto adjustment button while switching on the monitor’s power.

- To unlock

Switch off the monitor’s power by the power switch, then hold down the Auto adjustment button once again and turn the power back on.

Off Timer

The off timer function causes the monitor to automatically enter a power off state after a predetermined amount of time has lapsed. This function was created to reduce afterimage (p.34) characteristics that are particular to LCD monitors when the monitor screen is left on for a long period without use.

[Procedure]

- (1) Select <Off Timer> in the ScreenManager <Others> menu.
- (2) Select “Enable” and press the right and left buttons to adjust the “On Period” (1 to 23 hours).

[Off timer system]

PC	Monitor	LED
On Period (1H - 23H)	Operation	Blue
Last 15 min. in "On period"	Advance Notice ^{*1}	Blue Flashing
"On period" expired	Power off	Off

^{*1} Advance notice (LED flashing blue) will be given 15 minutes before the monitor automatically enters the “Power Off” mode. To delay entering the “Power Off” mode, press the power switch during the advance notice period. The monitor will continue to operate for an additional 90 minutes.

[Procedure]

Press the power switch.

NOTE

- The off timer function works while the PowerManager is active, but there is no advance notice before the monitor’s power is switched off.

EIZO Logo disappearing function

When switching on the power button on the front panel, the EIZO logo is displayed for a while. If you desire to display or undisplay this logo, use this function. (Default is logo appearing.)

- To undisplay
Switch off the monitor's power by the power switch, then hold down the Enter button once again and turn the power back on.
- To display
Switch off the monitor's power by the power switch, then hold down the Enter button once again and turn the power back on.

Automatically selecting the input signal function

The monitor will automatically detect the inputted signal of either the connection for display.

Connecting two PCs to the monitor

When the one computer is switched off or entering the power saving mode, the monitor will automatically display the other signal.

Use the ScreenManager to switch the input selection to manual.

[Procedure]

- (1) Select <Input Signal> in the <Others> menu.
- (2) Select <Manual>.

4. ADJUSTMENT

The monitor displays the digital input image correctly based on its pre-setting data. Adjust the contrast and brightness (p.23).

4-1. Screen Adjustment

Screen adjustments for the LCD monitor should be used in suppressing screen flickering and also for adjusting the screen to its proper position. There is only one correct position for each display mode. It is also recommended to use the ScreenManager function when first installing the display or whenever changing the system.

Adjustment Procedure

NOTE

- Allow the LCD monitor to stabilize for at least 20 minutes before making image adjustments.

1. Push the Auto adjustment button on the front panel.

The message “Your setting will be lost, if you press again now.” appears and remains on the screen for 5 seconds. While the message is on the screen, push the Auto adjustment button again to automatically adjust the clock, phase, and screen position. If you do not wish to do adjust the screen, do not push the Auto adjustment button again.

If the appropriate screen can not be made by using the Auto adjustment button, adjust the screen through the following procedures. If the appropriate screen can be made, proceed to step 4.

2. We recommend setting the desktop pattern to that as shown in the diagram below.

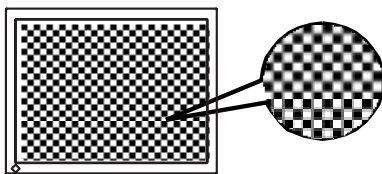

NOTE

- More precise adjustment is available for using the “Screen Adjustment program” utility software. It can be downloaded from the EIZO homepage (<http://www.eizo.com/>).

3. Adjust by using <Screen> menu in the ScreenManager.

(1) Vertical bars appear on the screen

→  Use the <Clock> (p.34) adjustment.

Select the <Clock> and eliminate the vertical bars by using the right and left of the control buttons.

Do not continuously press the control buttons, as the adjustment value will change quickly and make it difficult to locate the most suitable adjustment point. If the horizontal flickering, blur or bars appear, proceed to <Phase> adjustment as follows.



NOTE

- When adjusting the “Clock,” the horizontal screen size will also change.

(2) Horizontal bars appear on the screen.

→  Use the <Phase> (p.35) adjustment.

Select the <Phase> and eliminate the horizontal flickering, blurring or bars by using the right and left buttons.

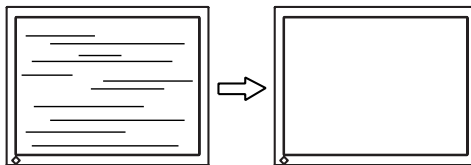

NOTE

- Horizontal bars may not completely disappear from the screen depending on the PC.

(3) The screen position is incorrect.

→  Use the <Position> adjustment.

The correct displayed position of the monitor is decided because the number and the position of the pixels are fixed. The “Position” adjustment moves the image to the correct position.

Select <Position> and adjust the position by using the up, down, right and left buttons.

If vertical bars of distortion appear after finishing the <Position> adjustment, return to <Clock> adjustment and repeat the previously explained adjustment procedure. Clock→ Phase→ Position

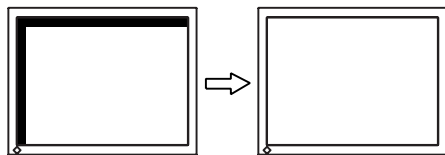

4. To adjust the output signal range (Dynamic Range) of the signal.

→  Use the <Range Adjustment> (p.35) of <ColorManagerment> menu.

This controls the level of output signal range to display the whole color gradation (256 colors).

[Procedure 1]

Push the Auto adjustment button on the front panel while displaying the <Range Adjustment> menu to automatically adjust the range. The screen blanks for a moment, and adjusts the color range to display the whole color gradation of the current output signal.

[Procedure 2]

Pressing Auto adjustment button while displaying the contrast/brightness adjustment screen (appeared by pressing the control buttons directly) adjusts the range automatically. (Contrast and Brightness will not be adjusted.)

5. To smooth the blurred texts of the enlarged screen of the lower resolutions.

→  Switch the <Smoothing> setting.

Select the suitable level from 1 – 5 (Soft – Sharp).

Select <Smoothing> in the <Screen> menu and adjust by using the right and left buttons.

NOTE

- The “Smoothing” is disabled in the resolution 1280 x 1024.
- Since the displayed image is enlarged, the blurred texts may not be necessarily lost completely.

6. To set the Contrast of the screen.

→  Use the <Contrast> adjustment.

This controls the brightness for the each color (red, blue and green) at the same time.

Select <Contrast/Brightness> and adjust by using the right and left buttons.

NOTE

- Percentage except 100 % may cause undisplayable color tone.
- During selecting the <sRGB> of <ColorManagement>, contrast cannot be adjusted.

7. To Set the Brightness of the screen.

→  Use the <Contrast> adjustment.

The brightness of the entire screen is controlled by changing the brightness of the backlight.

Select <Contrast/Brightness> in the screen menu and adjust by using the up and down buttons.

NOTE

- Directly pressing the up and down buttons also adjusts the contrast and brightness. Press the “Enter” button to save and exit the settings after the adjustment.

4-2. Color Adjustment

The <ColorManagement> menu in the ScreenManager enables to change the color of the screen. By using the <Color Mode>, the adjustment mode can be selected from <Custom mode> (to adjust the color settings according to your preference) and <sRGB> mode.

In the analog input, perform the “Range Adjustment” (p.22) before making the color adjustments.

NOTE

- Allow the LCD monitor to stabilize for at least 20 minutes before making image adjustments. (Allow the monitor to warm up for at least 20 minutes before making adjustments.)
- Performing the <Reset> of the <ColorManagement> menu returns the color settings to the default settings (Except <Range Adjustment> settings).
- The values shown in percentages represent the current level within the specific adjustment. They are available only as a reference tool. (To create an uniform white or black screen, the percentages for each will probably not be the same.)

<Custom> mode: To adjust the color settings according to your preference

To set the color temperature (p.34)

→  Set the <Temperature>.

The <Temperature> can be set from 4,000 K to 10,000 K, in 500 K increments (including 9,300 K). Default setting is off (normal white).

NOTE

- The values shown in the Kelvin are available only as a reference tool.
- Setting the temperature under 4,000 K or over 10,000 K invalidates the color temperature setting. (The color temperature's setting turns “OFF”.)

To change the saturation

→  Use the <Saturation> adjustment.

The <Saturation> can be selected from -128 to 127. Setting the minimum level (-128) turns the image to the monochrome.

NOTE

- The “Saturation” adjustment may cause undisplayable color tone.

To change the flesh color, etc.

→  Use the <Hue> adjustment

The <Hue> can be selected from - 32 to 32.

NOTE

- The “Hue” adjustment may cause undisplayable color tone.

To change each color (red, green and blue).

→  Use the <Gain> (p.34) adjustment.

By adjusting the red, green and blue color tones for each mode, custom colors can be defined. The 100 % indicates unadjusted condition. Display a white or gray background image and adjust the <Gain>.

NOTE

- The values shown in the percentage are available only as a reference tool.

To select <sRGB>

→ Select <sRGB> from the <Color Mode>

During selecting the <sRGB>, color and contrast cannot be adjusted.

4-3. Power-save Setup

The <PowerManager> menu in the ScreenManager enables to set the power-save setup.

NOTE

- Do your part to conserve energy, turn off the monitor when you are finished using it. Disconnecting the monitor from the power supply is recommended to save energy completely.

Analog input

This monitor complies with the VESA DPMS (p.35).

[Procedure]

- (1) Set the PC's power saving settings.
- (2) Select “VESA DPMS” from the <PowerManager> menu.

[Power saving system]

PC		Monitor	LED
Operation		Operation	Blue
Power saving	STAND-BY SUSPEND OFF	Power saving	Yellow

[Procedure]

Operate the mouse or keyboard to return to a normal screen.

Digital input

This monitor complies with the DVI DMPM (p.34).

[Procedure]

- (1) Set the PC's power saving settings.
- (2) Select "DVI DMPM" from the "PowerManager" menu.

[Power saving system]

PC	Monitor	LED
Operation	Operation	Blue
Power saving	Power saving	Yellow
Off mode	Power saving ^{*1}	Flashing yellow (2 times for each)

^{*1} Power saving through the PC's off mode is only supported when "Manual" is selected on the ScreenManager's <Input Signal>.

[Procedure]

Operate the mouse or keyboard to return to a normal screen from the Power save mode of the PC.

Power on the PC to return a normal screen from the Off mode of the PC.

Power save for speaker

When the monitor is in the power-saving mode, sound of speaker also erases simultaneously can be performed.

[Procedure]

- (1) Set the PC's power saving settings.
- (2) Select <Sound>.
- (3) Select "Disable". ("Enable" is selected to leave sound.)

5. ATTACHING AN ARM STAND

The LCD monitor can be used with an arm stand by removing the tilt stand and attaching the arm stand to the LCD monitor.

NOTE

- Use an arm stand that satisfies the followings.
 - When using the LCD monitor with an arm stand, the arm stand must be VESA approved :
 - * Use an arm stand with a 100 mm x 100 mm hole spacing on the arm mounting pad.
 - * Weight: Use an arm stand that is able to support an object weighting 13.5 kg (29.8 lbs.).
 - Use an arm stand with sufficient stability (mechanical firmness) to support the weight of the monitor.
 - Use an arm stand remaining that position where it is manually moved.
 - Use an arm stand with the ability to tilt the monitor forward and backward.
- Please connect cables after attaching an arm stand.

Setup Procedure

1. Lay the LCD monitor down. Do not scratch the panel.
2. Remove the tilt stand by loosening the screws (2 pcs of M4 x 10 mm).
3. Attach an arm stand to the LCD monitor securely.

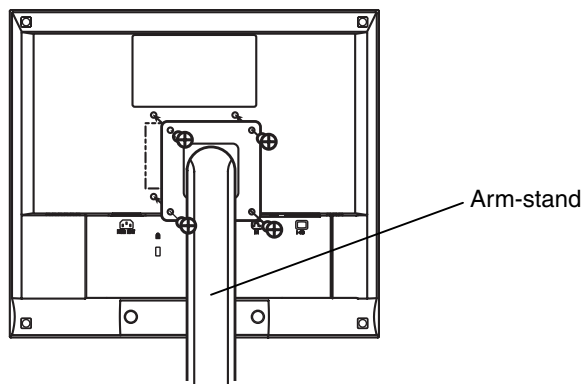



4 Mounting Screws (enclosed): M4 x 12 mm

6. TROUBLESHOOTING

If a problem persists even after applying the suggested remedies, contact an EIZO dealer.

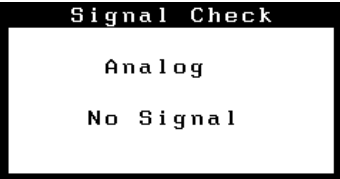
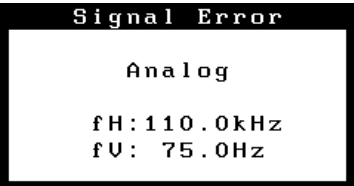
- No picture problems : See No.1 ~ No.2
- Imaging problems : See No.3 ~ No.11
- Other problems : See No.12 ~ No.14

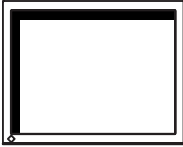
Problems	Points to check with possible solutions
1. No picture <ul style="list-style-type: none"> • Indicator status: Off 	<input type="checkbox"/> Check that the power cord is correctly connected. If the problem persists, turn off the monitor power for a few minutes, then turn it back on and try again.
<ul style="list-style-type: none"> • Indicator status: Blue • Indicator status: Yellow • Indicator status: Flashing yellow (2 times for each) 	<input type="checkbox"/> Check the “Contrast and Brightness” settings. <input type="checkbox"/> Switch the signal input by pressing the input signal selection button on the front control panel. <input type="checkbox"/> Try pressing a key on the keyboard, or clicking the mouse. (p.25) <input type="checkbox"/> Try pressing the power of the computer.
2. Following messages appear. (Error messages shown below will remain on the screen for 40 seconds.) 	<p>These message appear when the signal is not inputted correctly, even if the monitor functions properly.</p> <input type="checkbox"/> When the image is displayed correctly after a short time, there is no problem with the monitor. (Some PCs do not output the signal soon after powering on.) <input type="checkbox"/> Check that the PC is turned ON. <input type="checkbox"/> Check that the signal cable is properly connected to the PC or graphics board. <input type="checkbox"/> Switch the signal input by pressing the input signal selection button on the front control panel.
<ul style="list-style-type: none"> • Whenever an error signal message appears, the signal frequency will be displayed in red. (Example) 	<input type="checkbox"/> Use the graphics board's utility software to change the frequency setting. (Refer to the manual of the graphics board.)

Problems	Points to check with possible solutions
<p>3. Display position is incorrect.</p> 	<ul style="list-style-type: none"> <input type="checkbox"/> Adjust the image position using the <Position> (p.21) <input type="checkbox"/> The two display modes, VGA 720 x 400 (70 Hz) and 320 x 200 (70 Hz), have the same signal timings. Using this adjustment selects the appropriate display mode. (This function effects only when the resolution is VGA 720 x 400 (70 Hz) or 320 x 200 (70 Hz). <input type="checkbox"/> If the problem persists, use the graphics board's utility software to change the display position if available.
<p>4. Vertical bars of distortion appear.</p> 	<ul style="list-style-type: none"> <input type="checkbox"/> Decrease the vertical bars using the <Clock>. (p.21)
<p>5. Horizontal bars of distortion appear.</p> 	<ul style="list-style-type: none"> <input type="checkbox"/> Decrease the horizontal bars using the <Phase>. (p.21)
<p>6. Letters and lines appear blurred.</p>	<ul style="list-style-type: none"> <input type="checkbox"/> Switch the <Smoothing> mode to "Off". (p.22)
<p>7. The screen is too bright or too dark.</p>	<ul style="list-style-type: none"> <input type="checkbox"/> Adjust the <Contrast and brightness> (The baklight of the LCD monitor has a fixed life span. When the screen becomes dark or begins to flicker, please consult your dealer.)
<p>8. Afterimages appear.</p>	<ul style="list-style-type: none"> <input type="checkbox"/> When the screen image is changed after displaying the same image for a long period, an afterimage may appear. The "Afterimage" can be removed gradually by changing the displayed image. Use the "Off Timer" function and avoid keeping the screen on all the time. (p.18)
<p>9. The screen has defective pixels (e.g. slightly light or dark).</p>	<ul style="list-style-type: none"> <input type="checkbox"/> This is due to the characteristics of the panel itself, and not the LCD product.

Problems	Points to check with possible solutions
10. Fingerprints remain on the screen.	<input type="checkbox"/> Leaving the screen white may solve the problem.
11. The <Smoothing> cannot be selected.	<input type="checkbox"/> <Smoothing> is disabled when the screen is displayed in the 1280 x 1024.
12. The Enter button does not operate.	<input type="checkbox"/> The adjustment lock is probably on. To unlock: switch the LCD monitor off. Then, while pressing the Auto adjustment button switch, the power on. (p.18)
13. The Auto adjustment button does not operate.	<input type="checkbox"/> The adjustment lock is probably on. To unlock: switch the LCD monitor off. Then, while pressing the Auto adjustment button switch, the power on. (p.18) <input type="checkbox"/> The Auto sizing function is intended for use on the Macintosh and on AT-compatible PC running Windows. It may not work properly in either of the following cases. When running an AT-compatible PC on MS-DOS (Not windows). The background color for the “wall paper” or “desktop” pattern is set to black. Some signals from a graphics board may not function properly.
14. The signal selection button does not operate.	<input type="checkbox"/> The computer with digital may be in the off mode (power indicator flashing yellow). Try to press the monitor’s power switch and press the input signal selection button again.

7. CLEANING

Periodic cleaning is recommended to keep the monitor looking new and to prolong its operation lifetime.

NOTE

- Never use thinner, benzene, alcohol (ethanol, methanol, or isopropyl alcohol), abrasive cleaners, or other strong solvents, as these may cause damage to the cabinet or LCD panel.

Cabinet

To remove stains, wipe the cabinet with a soft, lightly moistened cloth using a mild detergent. Do not spray wax or cleaner directly into the cabinet. (For details, refer to the manual of the PC.)

LCD Panel

- The LCD surface can be cleaned with a soft cloth, such as cotton or lens paper.
- If necessary, stubborn stains can be removed by moistening part of a cloth with water to enhance its cleaning power.

8. SPECIFICATIONS

LCD Panel	43 cm (17.0 inch), TFT color LCD panel with Anti-Glare Hard Coating Viewing Angle: H: 170°, V: 170°
Dot Pitch	0.264 mm
Horizontal Scan Frequency	24.8 kHz - 80 kHz (Automatic) (Digital): 31.5~64 kHz
Vertical Scan Frequency	50 Hz ~75 Hz (Automatic) (Digital): 60Hz, (VGA Text : 70Hz)
Resolution	1280 dots x 1024 lines
Dot Clock (Max.)	135 MHz (Digital: 108 MHz)
Display Colors	16 million colors (max.)
Display Area	338 mm (H) x 270 mm (V) (13.3" (H) x 10.6" (V)) (Viewable image size: 432 mm (17.0"))
Power Supply	100-120/200-240 VAC±10%, 50/60 Hz, 0.7 A/0.4 A
Power Consumption	Max.: 45W Power Saving Mode: Less than 3 W
Input Connector	D-Sub mini 15 pin, DVI-D
Analog Input Signal (Sync)	Separate, TTL, Positive/Negative
Analog Input Signal (Video)	0.7Vp-p/75Ω Positive
Input Signal (Digital)	TMDS (Single Link)
Signal registration	Analog: 30 (Factory preset: 20)
Plug & Play	VESA DDC 2B
Amplifier Output (max.)	1 W + 1 W
Line input	Input impedance 47 kΩ (typ) Input sensitivity: 500 mV
Headphone output level	2 mW + 2 mW at Amplifier output 1 W + 1 W
Dimensions	380 mm (W) x 416 mm (H) x 178 mm (D) (15.0"(W) x 16.4"(H) x 7.0"(D))
Dimensions (without stand)	380 mm (W) x 353 mm (H) x 58 mm (D) (15.0"(W) x 13.9"(H) x 2.3"(D))
Weight	5.8 kg (12.8 lbs.)
Weight (without stand)	4.5 kg (9.9 lbs.)
Temperature	Operating: 0 °C ~ 35 °C (32 °F ~ 95 ° F) Storage: -20 °C ~ 60 °C (-4 °F ~ 140 ° F) Humidity 30% to 80% R.H. Non-condensing
Certifications and Standards	
100-120 VAC	NRTL/C-TÜV, FCC-B, TCO'99 ¹ , EPA ENERGY STAR Program, TÜV/Rheinland Ergonomics Approved
200-240 VAC	CE, CB, TÜV Rheinland/GS, TCO'99 ¹ , EPA ENERGY STAR Program, TÜV/Rheinland Ergonomics Approved

¹ Applicable to gray (standard) color version only.

Default settings

	Analog input	Digital input
Contrast	100%	
Brightness	100%	
Smoothing	3	
Color Management	Custom mode / Off (Normal white)	
PowerManager	VESA DPMS	DVI DMPM
Input Signal	Auto	
Off Timer	Disable	
Language	English	

Dimensions

Unit mm (inches)

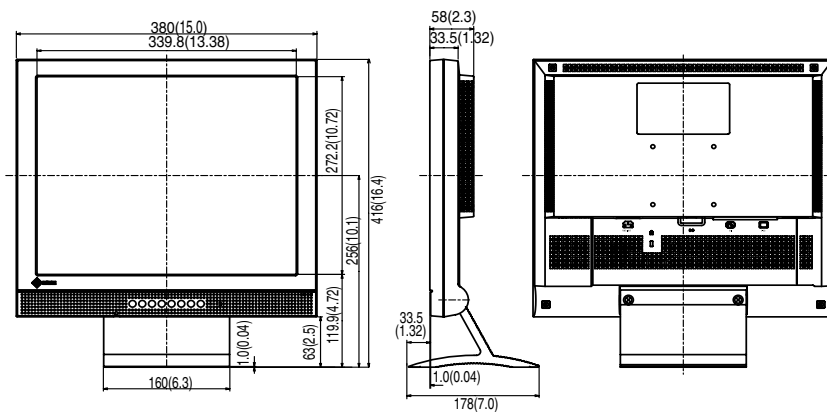

Pin Assignment

D-Sub mini 15 pin connector

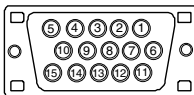

Pin No.	Signal	Pin No.	Signal	Pin No.	Signal
1	Red video	6	Red ground	11	Ground Shorted
2	Green video	7	Green ground	12	Data (SDA)
3	Blue video	8	Blue ground	13	H. Sync
4	Ground	9	No pin	14	V. Sync
5	No pin	10	Ground Shorted	15	Clock (SCL)

DVI-D Connector

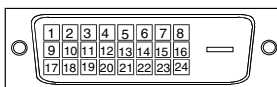

Pin No.	Signal	Pin No.	Signal	Pin No.	Signal
1	TMDS Data2-	9	TMDS Data1-	17	TMDS Data0-
2	TMDS Data2+	10	TMDS Data1+	18	TMDS Data0+
3	TMDS Data2/4 Shield	11	TMDS Data1/3 Shield	19	TMDS Data0/5 Shield
4	NC*	12	NC	20	NC
5	NC	13	NC	21	NC
6	DDC Clock (SCL)	14	+5V Power	22	TMDS Clock shield
7	DDC Data (SDA)	15	Ground (For +5V)	23	TMDS Clock+
8	Analog Vertical Sync	16	Hot Plug Detect	24	TMDS Clock-

(*NC: No Connection)

9. GLOSSARY

Afterimage

The Afterimage is particular to LCD monitors when the monitor screen is left on for a long period without use. The “Afterimage” can be removed gradually by changing the displayed image.

Clock

With the analog input signal display, the analog signal is converted to a digital signal by the LCD circuitry. To convert the signal correctly, the LCD monitor needs to produce the same number clock pulse as the dot clock of the graphics system. When the clock pulse is not correctly set, some vertical bars of distortion are displayed on the screen.

Color Temperature (Temperature)

Color Temperature is a method to measure the white color tone, generally indicated in degrees Kelvin. At high temperatures the white tone appears somewhat blue, while at lower temperatures it appears somewhat red. Computer monitors generally give best performance at high temperature settings.

5,000 K: Slightly reddish white.

6,500 K: Warm-white tone, similar to white paper or daylight.

9,300 K: Slightly bluish white.

DVI

(Digital Visual Interface)

A digital flat panel interface. DVI can transmit digital data from the PC directly without loss with the signal transition method “TMDS”.

There are two kinds of DVI connectors. One is DVI-D connector for digital signal input only. The other is DVI-I connector for both digital and analog signal inputs.

DVI DMPM

(DVI Digital Monitor Power Management)

The Power management system for the digital interface. The “Monitor ON” status (operation mode) and the “Active Off” status (power-saving mode) are indispensable for the DVI-DMPM as the monitor’s power mode.

Gain Adjustment

Adjusts each color parameter for red, green and blue. The color of the LCD monitor is displayed through the color filter of the LCD panel. Red, green and blue are the three primary colors. The colors on the monitor are displayed by combining these three colors. The color tone can change by adjusting the illumination amount passed through each color’s filter.

Phase

The phase adjustment decides the sampling timing point for converting the analog input signal to a digital signal. Adjusting the phase after the clock adjustment will produce a clear screen.

Range Adjustment

The Range Adjustment controls the level of output signal range to display the whole color gradation.

Resolution

The LCD panel consists of a fixed number of pixel elements which are illuminated to form the screen image. The EIZO L565 display panel consists of 1280 horizontal pixels and 1024 vertical pixels. At a resolution of 1280 x 1024, all pixels are displayed as a full screen.

sRGB (Standard RGB)

"International Standard for Red, Green, and Blue color space" A color space was defined with the aim of the color matching between applications and hardware devices, such as monitors, scanners, printers and digital cameras. As a standard default space, sRGB allows Internet users to closely match colors.

TMDS

(Transition Minimized Differential Signaling)

A signal transition method for the digital interface.

VESA DPMS

(Video Electronics Standard Association - Display Power Management Signaling)

The acronym VESA stands for "Video Electronics Standards Association", and DPMS stands for "Display Power Management Signaling." DPMS is a communication standard that PCs and graphics boards use to implement power savings on the monitor side.

APPENDIX/ANHANG/ANNEXE

Preset Timing Chart for Analog input Timing-Übersichten für Analog Eingang Synchronisation des Signaux pour Analog numerique

Based on the signal diagram shown below 20 factory presets have been registered in the monitor's microprocessor.

Der integrierte Mikroprozessor des Monitors unterstützt 20 werkseitige Standardeinstellungen (siehe hierzu die nachfolgenden Diagramme).

20 signaux ont été enregistrés en usine dans le microprocesseur du moniteur, conformément au diagramme de synchronisation ci-dessous.

A	Front Porch	Vordere Schwarzschiulter	Front avant
B	Sync Period	Synchronimpuls	Délai de synchronisation
C	Back Porch	Hintere Schwarzschiulter	Front arrière
D	Blanking Period	Austastzeit	Délai de clignotement
E	Display period	Displya-Zeit	Délai d'affichage
F	Total cycle	Kompletter Zyklus	Cycle total
H	Sync signal level	Sync-Signalpegel	Niveau du signal de synchronisation
V	Video signal level	Video-Signalpegel	Niveau du signal vidéo

Mode	Dot Clock MHz	Sync Polarity		Frequencies		A: Front Porch		B: Sync Period	
		H	V	H kHz	V Hz	H μ s/Dot	V ms/Line	H μ s/ Dot	V ms/ Line
VGA 640 x 480	25.2	Nega.	Nega.	31.47	59.94	0.636/ 16	0.318/ 10	3.813/ 96	0.054/ 2
VGA 720 x 400	28.3	Nega.	Posi.	31.47	70.09	0.636/ 18	0.381/ 12	3.813/ 108	0.064/ 2
Macintosh 640 x 480	30.2	Posi.	Posi.	35.00	66.67	2.116/ 64	0.086/ 3	2.116/ 64	0.086/ 3
Macintosh 832 x 624	57.3	Posi.	Posi.	49.73	74.55	0.559/ 32	0.020/ 1	1.117/ 64	0.060/ 3
Macintosh 1152 x 870	100.0	Posi.	Posi.	68.68	75.06	0.320/ 32	0.044/ 3	1.280/ 128	0.044/ 3
Macintosh 1280x960	126.2	Posi.	Posi.	74.76	74.76	0.190/ 24	0.013/ 1	1.204/ 152	0.0401/ 3
VESA 640 x 480	31.5	Nega.	Nega.	37.86	72.81	0.508/ 16	0.026/ 1	1.270/ 40	0.079/ 3
VESA 640 x 480	31.5	Nega.	Nega.	37.50	75.00	0.508/ 16	0.027/ 1	2.032/ 67	0.080/ 3
VESA 800 x 600	36.0	Posi.	Posi.	35.16	56.25	0.667/ 24	0.028/ 1	2.000/ 72	0.057/ 2
VESA 800 x 600	40.0	Posi.	Posi.	37.88	60.32	1.000/ 40	0.026/ 1	3.200/ 128	0.106/ 4
VESA 800 x 600	50.0	Posi.	Posi.	48.08	72.19	1.120/ 56	0.770/ 37	2.400/ 120	0.125/ 6
VESA 800 x 600	49.5	Posi.	Posi.	46.88	75.00	0.323/ 16	0.021/ 1	1.616/ 80	0.064/ 3
VESA 1024 x 768	65.0	Nega.	Nega.	48.36	60.00	0.369/ 24	0.062/ 3	2.092/ 136	0.124/ 6
VESA 1024 x 768	75.0	Nega.	Nega.	56.48	70.07	0.320/ 24	0.053/ 3	1.813/ 136	0.106/ 6
VESA 1024 x 768	78.8	Posi.	Posi.	60.02	75.03	0.203/ 16	0.017/ 1	1.219/ 96	0.050/ 3
VESA 1280 x 960	60.0	Posi.	Posi.	60.00	60.00	0.889/ 96	0.017/ 1	1.037/ 112	0.050/ 3
VESA 1152 x 864	108.0	Posi.	Posi.	67.50	75.00	0.593/ 64	0.015/ 1	1.185/ 128	0.044/ 3
VESA 1280 x 1024	108.0	Posi.	Posi.	63.98	60.02	0.444/ 48	0.016/ 1	1.037/ 112	0.047/ 3
VESA 1280 x 1024	135.0	Posi.	Posi.	79.98	75.03	0.119/ 16	0.013/ 1	1.067/ 144	0.038/ 3
VGA Graphics 320 x 200	21.2	Nega.	Posi	31.47	70.09	0.336/ 16	0.381/ 12	3.813/ 96	0.064/ 2

C: Back Porch		D: Blanking Period		E: Display Period		F: Total Cycle	
H μ s/ Dot	V ms/ Line	H μ s/ Dot	V ms/ Line	H μ s/ Dot	V ms/ Line	H μ s/ Dot	V ms/ Line
1.907/ 48	1.049/ 33	6.356/ 160	1.430/ 45	25.442/ 640	15.253/ 480	31.778/ 800	16.683/ 525
1.907/ 54	1.112/ 35	6.355/ 180	1.557/ 49	25.422/ 720	12.711/ 400	31.778/ 900	14.267/ 449
3.175/ 96	1.114/ 39	7.407/ 224	1.286/ 45	21.164/ 640	13.714/ 480	28.571/ 864	15.000/ 525
3.911/ 224	0.784/ 39	5.587/ 320	0.865/ 43	14.525/ 832	12.550/ 624	20.112/ 1152	13.414/ 667
1.440/ 144	0.568/ 39	3.040/ 304	0.655/ 45	11.520/ 1152	12.667/ 870	14.560/ 1456	13.322/ 915
1.838/ 232	0.482/ 36	3.233/ 408	0.535/ 40	10.143/ 1280	12.841/ 960	13.376/ 1688	13.379/ 1000
3.810/ 120	0.528/ 20	5.587/ 176	0.634/ 24	20.317/ 640	12.678/ 480	26.413/ 832	13.735/ 520
3.810/ 120	0.427/ 16	6.349/ 200	0.533/ 20	20.317/ 640	12.800/ 481	26.667/ 840	13.333/ 500
3.556/ 128	0.626/ 22	6.222/ 224	0.711/ 25	22.222/ 800	17.067/ 600	28.444/ 1024	17.778/ 625
2.200/ 88	0.607/ 23	6.400/ 256	0.739/ 28	20.000/ 800	15.840/ 600	26.400/ 1056	16.579/ 628
1.280/ 64	0.478/ 23	4.800/ 240	1.373/ 66	16.000/ 800	12.480/ 600	20.800/ 1040	13.853/ 666
3.232/ 160	0.448/ 21	5.172/ 256	0.533/ 25	16.162/ 800	12.800/ 600	21.333/ 1056	13.333/ 625
2.462/ 160	0.600/ 29	4.923/ 320	0.786/ 38	15.754/ 1024	15.880/ 768	20.677/ 1344	16.666/ 806
19.20/ 144	0.513/ 29	4.053/ 304	0.673/ 38	13.653/ 1024	13.599/ 768	17.707/ 1328	14.272/ 806
2.235/ 176	0.466/ 28	3.657/ 288	0.533/ 32	13.003/ 1024	12.795/ 768	16.660/ 1312	13.328/ 800
2.889/ 312	0.600/ 36	4.815/ 520	0.667/ 40	11.852/ 1280	16.000/ 960	16.667/ 1800	16.667/ 1000
2.370/ 256	0.0.474/ 32	4.148/ 448	0.553/ 36	10.667/ 1152	12.800/ 864	14.815/ 1600	13.333/ 900
2.296/ 248	0.594/ 38	3.778/ 408	0.656/ 42	11.852/ 1280	16.005/ 1024	15.630/ 1688	16.661/ 1066
1.837/ 248	0.475/ 38	3.022/ 408	0.525/ 42	9.481/ 1280	12.804/ 1024	12.504/ 1688	13.329/ 1066
1.907/ 48	1.112/ 35	6.356/ 160	1.557/ 49	25.422/ 640	12.711/ 400	31.778/ 800	14.268/ 449

[Applicable to gray (standard color version only).]



Congratulations!

You have just purchased a TCO'99 approved and labelled product! Your choice has provided you with a product developed for professional use. Your purchase has also contributed to reducing the burden on the environment and also to the further development of environmentally adapted electronics products.

Why do we have environmentally labelled computers?

In many countries, environmental labelling has become an established method for encouraging the adaptation of goods and services to the environment. The main problem, as far as computers and other electronics equipment are concerned, is that environmentally harmful substances are used both in the products and during their manufacture. Since it is not so far possible to satisfactorily recycle the majority of electronics equipment, most of these potentially damaging substances sooner or later enter nature.

There are also other characteristics of a computer, such as energy consumption levels, that are important from the viewpoints of both the work (internal) and natural (external) environments. Since all methods of electricity generation have a negative effect on the environment (e.g. acidic and climate-influencing emissions, radioactive waste), it is vital to save energy. Electronics equipment in offices is often left running continuously and thereby consumes a lot of energy.

What does labelling involve?

This product meets the requirements for the TCO'99 scheme which provides for international and environmental labelling of personal computers. The labelling scheme was developed as a joint effort by the TCO (The Swedish Confederation of Professional Employees), Svenska Naturskyddsforeningen (The Swedish Society for Nature Conservation) and Statens Energimyndighet (The Swedish National Energy Administration).

Approval requirements cover a wide range of issues: environment, ergonomics, usability, emission of electric and magnetic fields, energy consumption and electrical and fire safety.

The environmental demands impose restrictions on the presence and use of heavy metals, brominated and chlorinated flame retardants, CFCs (freons) and chlorinated solvents, among other things. The product must be prepared for recycling and the manufacturer is obliged to have an environmental policy which must be adhered to in each country where the company implements its operational policy.

The energy requirements include a demand that the computer and/or display, after a certain period of inactivity, shall reduce its power consumption to a lower level in one or more stages. The length of time to reactivate the computer shall be reasonable for the user.

Labelled products must meet strict environmental demands, for example, in respect of the reduction of electric and magnetic fields, physical and visual ergonomics and good usability.

You will find a brief summary of the environmental requirements met by this product on the right. The complete environmental criteria document may be ordered from:

TCO Development

SE-114 94 Stockholm, Sweden

Fax: +46 8 782 92 07

Email (Internet): development@tco.se

Current information regarding TCO'99 approved and labelled products may also be obtained via the Internet, using the address: <http://www.tco-info.com/>

Environmental Requirements

Flame retardants

Flame retardants are present in printed circuit boards, cables, wires, casings and housings. Their purpose is to prevent, or at least to delay the spread of fire. Up to 30% of the plastic in a computer casing can consist of flame retardant substances. Most flame retardants contain bromine or chloride, and those flame retardants are chemically related to another group of environmental toxins, PCBs. Both the flame retardants containing bromine or chloride and the PCBs are suspected of giving rise to severe health effects, including reproductive damage in fish-eating birds and mammals, due to the bio-accumulative* processes. Flame retardants have been found in human blood and researchers fear that disturbances in foetus development may occur.

The relevant TCO'99 demand requires that plastic components weighing more than 25 grams must not contain flame retardants with organically bound bromine or chlorine. Flame retardants are allowed in the printed circuit boards since no substitutes are available.

Cadmium**

Cadmium is present in rechargeable batteries and in the colour-generating layers of certain computer displays. Cadmium damages the nervous system and is toxic in high doses.

The relevant TCO'99 requirement states that batteries, the colour-generating layers of display screens and the electrical or electronics components must not contain any cadmium.

Mercury**

Mercury is sometimes found in batteries, relays and switches. It damages the nervous system and is toxic in high doses.

The relevant TCO'99 requirement states that batteries may not contain any mercury. It also demands that mercury is not present in any of the electrical or electronics components associated with the labelled unit.

CFCs (freons)

The relevant TCO'99 requirement states that neither CFCs nor HCFCs may be used during the manufacture and assembly of the product. CFCs (freons) are sometimes used for washing printed circuit boards. CFCs break down ozone and thereby damage the ozone layer in the stratosphere, causing increased reception on earth of ultraviolet light with e.g. increased risks of skin cancer (malignant melanoma) as a consequence.

Lead**

Lead can be found in picture tubes, display screens, solders and capacitors. Lead damages the nervous system and in higher doses, causes lead poisoning.

The relevant TCO'99 requirement permits the inclusion of lead since no replacement has yet been developed.

* Bio-accumulative is defined as substances which accumulate within living organisms.

** Lead, Cadmium and Mercury are heavy metals which are Bio-accumulative.

For U.S.A, Canada, etc. (rated 100-120 Vac) Only

FCC Declaration of Conformity

We, the Responsible Party

EIZO NANAOTECHNOLOGIES INC.
5710 Warland Drive, Cypress, CA 90630
Phone: (562) 431-5011

declare that the product

Trade name: EIZO
Model: FlexScan L565

is in conformity with Part 15 of the FCC Rules. Operation of this product is subject to the following two conditions: (1) this device may not cause harmful interference, and (2) this device must accept any interference received, including interference that may cause undesired operation.

This equipment has been tested and found to comply with the limits for a Class B digital device, pursuant to Part 15 of the FCC Rules. These limits are designed to provide reasonable protection against harmful interference in a residential installation. This equipment generates, uses, and can radiate radio frequency energy and, if not installed and used in accordance with the instructions, may cause harmful interference to radio communications. However, there is no guarantee that interference will not occur in a particular installation. If this equipment does cause harmful interference to radio or television reception, which can be determined by turning the equipment off and on, the user is encouraged to try to correct the interference by one or more of the following measures.

- * Reorient or relocate the receiving antenna.
- * Increase the separation between the equipment and receiver.
- * Connect the equipment into an outlet on a circuit different from that to which the receiver is connected.
- * Consult the dealer or an experienced radio/TV technician for help.

Changes or modifications not expressly approved by the party responsible for compliance could void the user's authority to operate the equipment.

Note

Use the attached specified cable below or EIZO signal cable with this monitor so as to keep interference within the limits of a Class B digital device.

- AC Cord
- Shielded Signal Cable (D-SUB mini 15 pin - D-SUB mini 15 pin, the enclosed signal cable)
- Stereo mini-jack cable

Canadian Notice

This Class B digital apparatus complies with Canadian ICES-003.

Cet appareil numérique de la classe B est conforme à la norme NMB-003 du Canada.

Hinweis zur Ergonomie :

Dieser Monitor erfüllt die Anforderungen an die Ergonomie nach EK1-ITB 2000 mit dem Videosignal, 1280 Punkte × 1024 Zeilen, RGB analog, 0,7 Vp-p und mindestens 75,0 Hz Bildwiederholfrequenz, non interlaced. Weiterhin wird aus ergonomischen Gründen empfohlen, die Grundfarbe Blau nicht auf dunklem Untergrund zu verwenden (schlechte Erkennbarkeit, Augenbelastung bei zu geringem Zeichenkontrast.)

Recycle Auskunft

Die Rücknahme dieses Produktes nach Nutzungsende übernimmt EIZO in Deutschland zusammen mit dem Partner von Roll MBB Recycling GmbH. Dort werden die Geräte in ihre Bestandteile zerlegt, die dann der Wiederverwertung zugeführt werden. Um einen Abholtermin zu vereinbaren und die aktuellen Kosten zu erfahren, benutzen Sie bitte folgende Rufnummer: 02153-73 35 00. Weitere Informationen finden Sie auch unter der Internet-Adresse: www.eizo.de.

Free Manuals Download Website

<http://myh66.com>

<http://usermanuals.us>

<http://www.somanuals.com>

<http://www.4manuals.cc>

<http://www.manual-lib.com>

<http://www.404manual.com>

<http://www.luxmanual.com>

<http://aubethermostatmanual.com>

Golf course search by state

<http://golfingnear.com>

Email search by domain

<http://emailbydomain.com>

Auto manuals search

<http://auto.somanuals.com>

TV manuals search

<http://tv.somanuals.com>