



USER'S GUIDE

V:1013-0219-09

PD7709B
Dual 7" Screen DVD Player

CONTENTS

» QUICK START	4
POWERING THE UNIT	4
AC/DC ADAPTER	4
DC CAR ADAPTER.....	4
PLAYING A DVD	4
CONNECTING THE INCLUDED SCREEN	4
GENERAL PRODUCT INFORMATION	5
WHAT'S IN THE BOX	5
FEATURES.....	5
POWER OPTIONS	5
AC/DC ADAPTER	5
REMOTE BATTERIES	5
DC CAR ADAPTER.....	5
OPERATIONS	6
PLAYING A DVD	6
OPERATIONS	7
CONNECTING THE INCLUDED SCREEN	7
OPERATIONS	8
PLAYING A CD	8
OPERATIONS	9
PROGRAMING A CD.....	9
PROGRAMING A DVD.....	9
OPERATIONS	10
USING THE HEADREST STRAPS	10
SETUP MENU	11
LANGUAGE SETUP PAGE	11
AUDIO SETUP PAGE.....	11
VIDEO SETUP PAGE	11
SYSTEM SETUP PAGE.....	11
UNIT CONTROL LOCATIONS	12
UNIT CONTROL GLOSSARY	13
UNIT CONTROL LOCATIONS	14
UNIT CONTROL GLOSSARY	15
REMOTE CONTROL LOCATIONS	16
REMOTE CONTROL GLOSSARY	17
REMOTE CONTROL LOCATIONS	18
REMOTE CONTROL GLOSSARY	19
COMPANY INFORMATION	20
GREEN INITIATIVE	20
INTERNATIONAL SUPPORT	20
SERVICE INFORMATION.....	20

WARNINGS AND PRECAUTIONS

- CAUTION: USE OF ANY CONTROLS, ADJUSTMENTS, OR PROCEDURES OTHER THAN THOSE SPECIFIED HEREIN MAY RESULT IN HAZARDOUS RADIATION EXPOSURE.
- CAUTION: DANGER OF EXPLOSION IF BATTERY IS INCORRECTLY REPLACED. REPLACE ONLY WITH THE SAME OR EQUIVALENT TYPE.
- TO PREVENT FIRE OR SHOCK HAZARD, DO NOT USE THIS PLUG WITH AN EXTENSION CORD, RECEPTACLE OR OTHER OUTLET UNLESS THE BLADES CAN BE FULLY INSERTED TO PREVENT BLADE EXPOSURE.
- WARNING: TO REDUCE THE RISK OF FIRE OR ELECTRIC SHOCK, DO NOT EXPOSE THIS APPLIANCE TO RAIN OR MOISTURE.
- WARNING: THE BATTERIES SHALL NOT BE EXPOSED TO EXCESSIVE HEAT SUCH AS SUNSHINE, FIRE OR THE LIKE.



The lightning flash with arrowhead symbol, within an equilateral triangle, is intended to alert the user to the presence of uninsulated "dangerous voltage" within the product's enclosure that may be of sufficient magnitude to constitute a risk of electric shock to persons.

CAUTION

RISK OF ELECTRIC SHOCK
DO NOT OPEN

WARNING: TO REDUCE THE RISK OF ELECTRIC SHOCK, DO NOT REMOVE COVER (OR BACK). NO USER-SERVICEABLE PARTS INSIDE. REFER SERVICING TO QUALIFIED SERVICE PERSONNEL.



The exclamation point within an equilateral triangle is intended to alert the user to the presence of important operating and maintenance (servicing) instructions in the literature accompanying the appliance.



This product utilizes a Class 1 laser to read Compact Discs. This laser Compact Disc Player is equipped with safety switches to avoid exposure when the CD door is open and the safety interlocks are defeated. Invisible laser radiation is present when the CD Player's lid is open and the system's interlock has failed or been defeated. It is very important that you avoid direct exposure to the laser beam at all times. Please do not attempt to defeat or bypass the safety switches.

IMPORTANT SAFETY INSTRUCTIONS

1. Read these instructions.
2. Keep these instructions.
3. Heed all warnings.
4. Follow all instructions.
5. Do not use this apparatus near water.
6. Clean only with dry cloth.
7. Do not block any ventilation openings. Install in accordance with the manufacturer's instructions.
8. Do not install near any heat sources such as radiators, heat registers, stoves, or other apparatus (including amplifiers) that produce heat.
9. Do not defeat the safety purpose of the polarized or grounding-type plug. A polarized plug has two blades with one wider than the other. A grounding type plug has two blades and a third grounding prong. The wide blade or the third prong are provided for your safety. If the provided plug does not fit into your outlet, consult an electrician for replacement of the obsolete outlet.
10. Protect the power cord from being walked on or pinch particularly at plugs, convenience receptacles, and the point where they exit from the apparatus.
11. Only use attachments/accessories specified by the manufacturer.
12. Use only with the cart, stand, tripod, bracket, or table specified by the manufacturer, or sold with the apparatus. When a cart is used, use caution when moving the cart/apparatus combination to avoid injury from tip-over.
13. Unplug this apparatus during lightning storms or when unused for long periods of time.
14. Refer all servicing to qualified service personnel. Servicing is required when the apparatus has been damaged in any way, such as power-supply cord or plug is damaged, liquid has been spilled or objects have fallen into the apparatus, the apparatus has been exposed to rain or moisture, does not operate normally, or has been dropped.
15. This appliance shall not be exposed to dripping or splashing water and that no object filled with liquid such as vases shall be placed on the apparatus.
16. CAUTION: Visible and Invisible Laser Radiation when open and interlock defeated.
DO NOT STARE INTO BEAM.
17. Rating label is located at the bottom of enclosure.
18. "CAUTION" mark is also located at the bottom of enclosure.



Additional Warnings

- The apparatus shall not be exposed to dripping or splashing and that no objects filled with liquids, such as vases, shall be placed on apparatus.
L'appareil ne doit pas être exposé aux écoulements ou aux éclaboussures et aucun objet ne contenant de liquide, tel qu'un vase, ne doit être placé sur l'objet.
- Main plug is used as disconnect device and it should remain readily operable during intended use. In order to disconnect the apparatus from the mains completely, the mains plug should be disconnected from the mains socket outlet completely.
La prise du secteur ne doit pas être obstruée ou doit être facilement accessible pendant son utilisation. Pour être complètement déconnecté de l'alimentation d'entrée, la prise doit être débranchée du secteur.
- Battery shall not be exposed to excessive heat such as sunshine, fire or the like.
Les piles ne doivent pas être exposées à de forte chaleur, tel qu'à la lumière du soleil, au feu ou autres choses de semblable.
- Caution marking is located at the bottom of apparatus.
Les précautions d'emploi sont inscrites en bas de l'appareil.
- The marking information is located at the bottom of apparatus.
Les marquages sont inscrits en bas de l'appareil.

FCC Warnings

NOTE: This equipment has been tested and found to comply with the limits for a Class B digital device, pursuant to Part 15 of the FCC Rules. These limits are designed to provide reasonable protection against harmful interference in a residential installation. This equipment generates, uses, and can radiate radio frequency energy and, if not installed and used in accordance with the instructions, may cause harmful interference to radio communications. However, there is no guarantee that interference will not occur in a particular installation. If this equipment does cause harmful interference to radio or television reception, which can be determined by turning the equipment off and on, the user is encouraged to try to correct the interference by one or more of the following measures:

- Reorient or relocate the receiving antenna.
- Increase the separation between the equipment and receiver.
- Connect the equipment into an outlet on a circuit different from that to which the receiver is connected.
- Consult the dealer or an experienced radio/TV technician for help.

QUICK START

POWERING THE UNIT

Power the unit by connecting it to one of the following power sources.

AC/DC ADAPTER

Use the 9V AC/DC Adapter to connect the unit to a standard AC outlet.

DC CAR ADAPTER

Use the 12V DC Car Adapter to connect the unit to a vehicle's DC Power Outlet, such as a car lighter outlet.

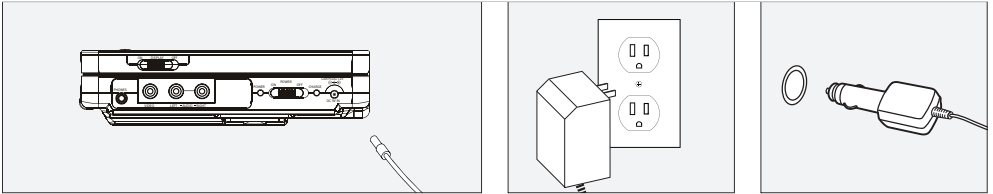

Adjust the **Power Switch** to the "ON" position to power the unit on.

PLAYING A DVD

Load a DVD into the player.

The DVD should start playing automatically.

1. If the DVD does not start playing automatically, press the **Play/Pause Button**.

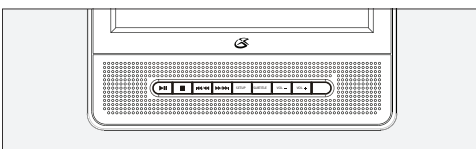
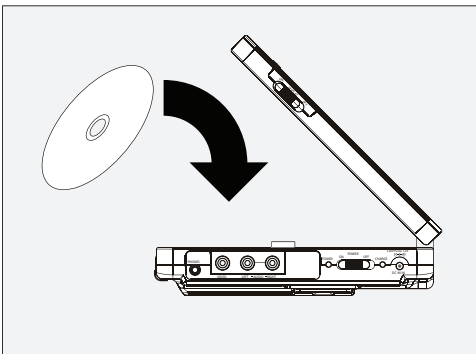

CONNECTING THE INCLUDED SCREEN

The included Screen has a DC Power Input and a DC Power Output.

1. To power both the main unit and the screen, connect the AC/DC Adapter or DC Car Adapter directly to the screen, then use the included power cable to connect the screen and main unit.
2. Connect the included Composite A/V Cable to the video and audio outputs on the main unit to the video and audio inputs on the screen.

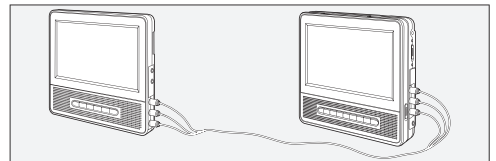
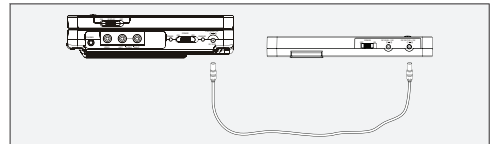

WHAT'S IN THE BOX

PD7709B

AC/DC Adapter

DC Car Adapter

Remote Control

Composite Video/Right and Left Audio Cable

Player to Screen Power Cable

2 Sets of Stereo Earbuds

Documentation

FEATURES

DVD player: DVD, DVD±R/RW, CD, CD-R/RW, JPEG CD

Dual 7" TFT screens

Supports multiple languages and language subtitles

Built-in speakers

Video/audio output

Stereo headphone jack

Video/audio input

Stereo headphone jack

AC power

DC power: 12V DC car adapter

POWER OPTIONS

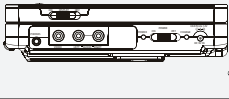

AC/DC ADAPTER

Use the 9V AC/DC Adapter to connect the unit to a standard AC outlet.

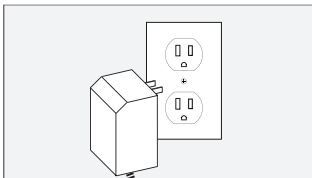

DC CAR ADAPTER

Use the 12V DC Car Adapter to connect the unit to a vehicle's DC Power Outlet, such as a car lighter outlet.

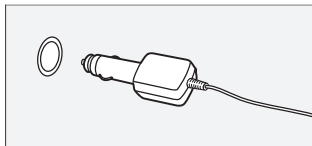

REMOTE BATTERIES

The Remote Control requires 2 AAA batteries.

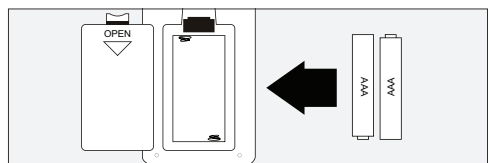

PLAYING A DVD

Load a DVD into the player.

1. Adjust the **Power Switch** to the “ON” position.

The DVD should start playing automatically.

2. If the DVD does not start playing automatically, press the **Play/Pause Button**.

- Press the **Skip/Search Buttons** to skip through chapters on a loaded DVD.

Press and hold the **Skip/Search Buttons** to fast-forward and rewind through a loaded DVD.

- Press the **Stop Button** to stop a DVD during play.
- Press the **Subtitle Button** to access the different subtitle options for the loaded DVD.
- Press the **Audio Button** on the remote to access the different audio options for the loaded DVD.

- Press the **Program Button** to program a loaded DVD to play chapters in a chosen order.

Up to 20 items can be programmed at any one time.

- Press the **Repeat Button** once to repeat the current DVD chapter.

Press the **Repeat Button** twice to repeat the current title.

Press the **Repeat Button** three times to repeat the entire DVD.

Press the **Repeat Button** four times to turn the repeat function off.

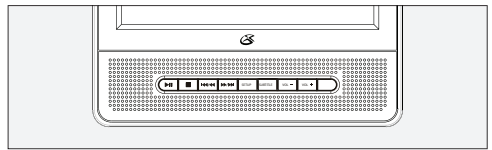
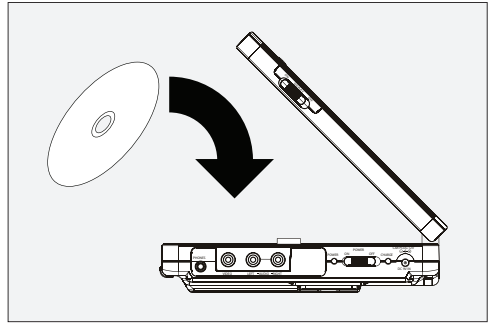

- Press the **Repeat Button** five times to set a repeat starting point (A).

Press the **Repeat Button** six times to set a repeat ending point (B).

Press the **Repeat Button** seven times to turn the repeat function off.

- Press the **Title Button** to return to the title menu of a loaded DVD.

- Press the **Display Button** to view the on-screen display for the loaded DVD.

- Press the **Menu Button** to return to the menu on a loaded DVD.

- Press and hold the **Angle Button** to view different angles of a loaded DVD.

Please note: the loaded DVD must include angle options for the angle button to work.

- Press the **Zoom Button** to zoom in on the loaded DVD.

- Press and hold the **Slow Button** to view the loaded DVD in slow motion.

CONNECTING THE INCLUDED SCREEN

The included Screen has a DC Power Input and a DC Power Output.

1. To power both the main unit and the screen, connect the AC/DC Adapter or DC Car Adapter directly to the screen, then use the included power cable to connect the screen and main unit.

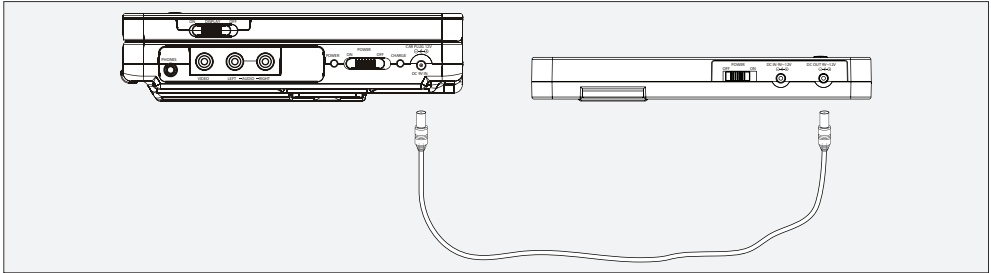
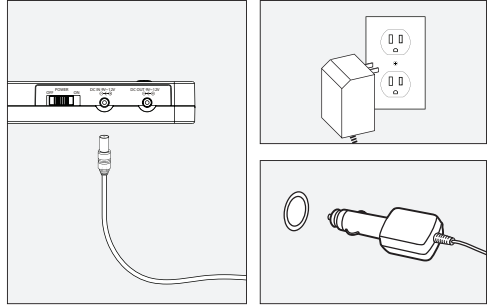

2. Connect the included Composite A/V Cable to the video and audio outputs on the main unit to the video and audio inputs on the screen.

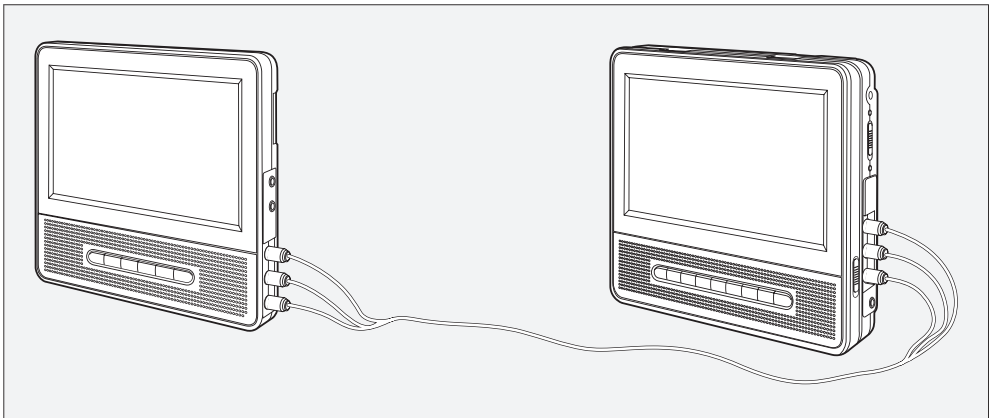

PLAYING A CD

Load a CD into the player.

1. Adjust the **Power Switch** to the “ON” position.

The CD should start playing automatically.

2. If the CD does not start playing automatically, press the **Play/Pause Button**.

- Press the **Skip/Search Buttons** to skip through chapters on a loaded CD.

Press and hold the **Skip/Search Buttons** to fast-forward and rewind through a loaded CD.

- Press the **Stop Button** to stop a CD during play.

- Press the **Repeat Button** once to repeat the current CD track.

Press the **Repeat Button** twice to repeat the entire album.

Press the **Repeat Button** three times to turn the repeat function off.

- Press the **Repeat Button** four times to set a repeat starting point (A).

Press the **Repeat Button** five times to set a repeat ending point (B).

Press the **Repeat Button** six times to turn the repeat function off.

- Press the **Display Button** to view the on-screen display for the loaded CD.
- Press the **Program Button** to program a loaded CD to play tracks in a chosen order.

Up to 20 items can be programmed at any one time.

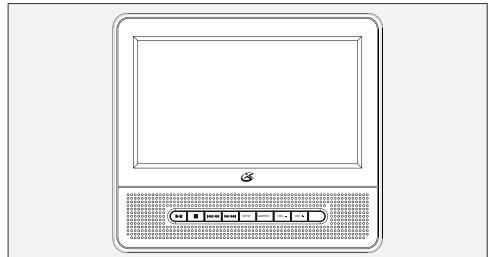
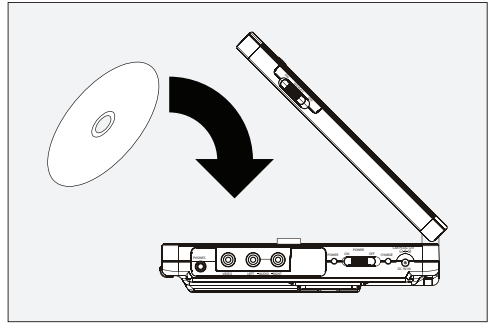

 Track

 All

Repeat Off

 A

 AB

Repeat Off

PROGRAMING A CD

Load a CD into the player.

1. Adjust the **Power Switch** to the “ON” position.

The CD should start playing automatically.

2. Press the **Program Button**.
3. Use the **Number Keypad** to enter in the track numbers in the order you want them to play.

Up to 20 tracks can be programmed at one time.

4. Use the **Directional Buttons** to highlight the “Start” option on the display, and press the **Select Button**.
- Press the **Stop Button** twice to reset the programmed tracks.

PROGRAMING A DVD

Load a DVD into the player.

1. Adjust the **Power Switch** to the “ON” position.

The DVD should start playing automatically.

2. Press the **Program Button**.
3. Use the **Number Keypad** to enter in the title and chapter numbers in the order you want them to play.

Up to 20 titles and chapters can be programmed at one time.

4. Use the **Directional Buttons** to highlight the “Start” option on the display, and press the **Select Button**.
- Press the **Stop Button** twice to reset the programmed tracks.

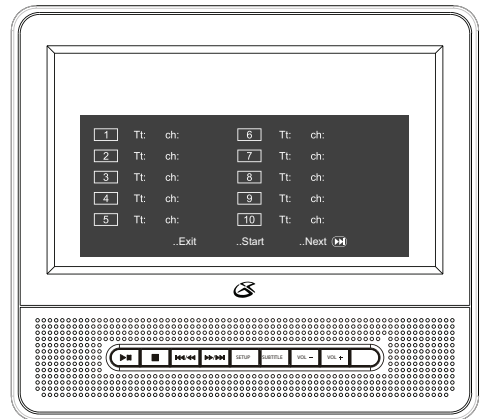
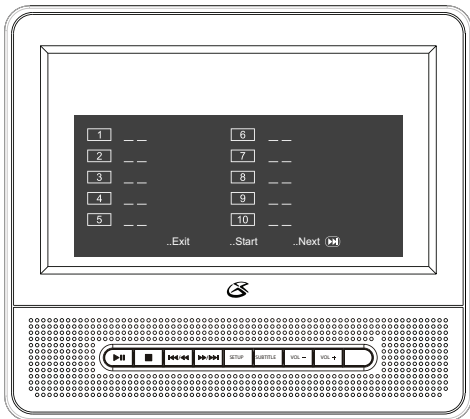

USING THE HEADREST STRAPS

1. Slide the main unit and the included screen into their headrest strap cases.
2. Run the headrest strap through the **Head Rest Strap Connections** on the back of the main unit and the included screen.
3. Tighten the straps around the headrests of a vehicles seats.

Main Unit Headrest Strap Connection

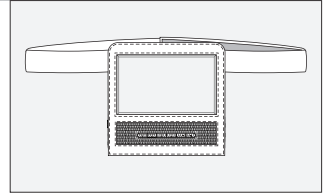
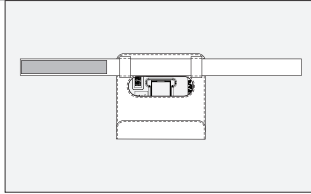
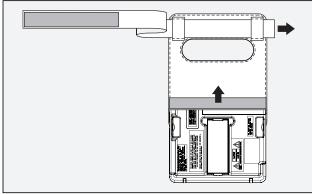

Screen Headrest Strap Connection

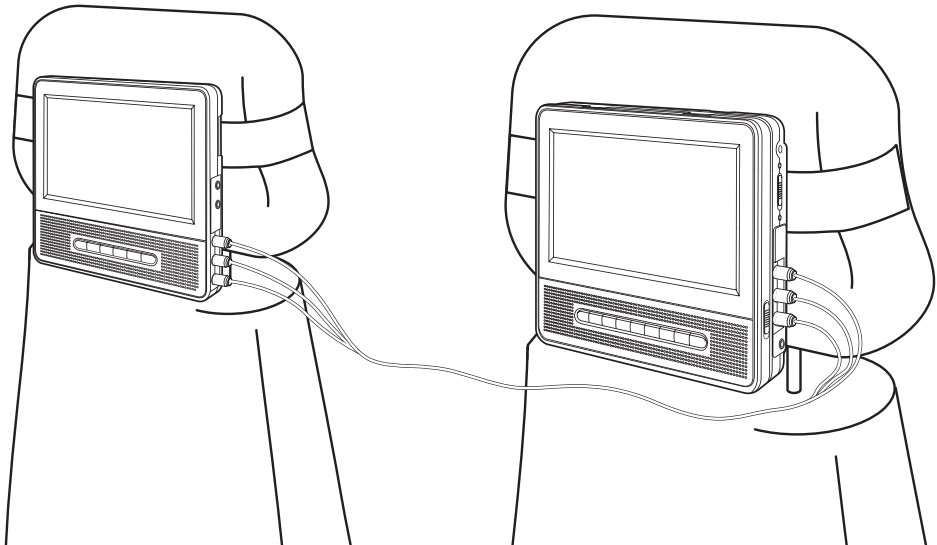
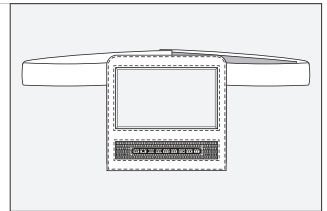
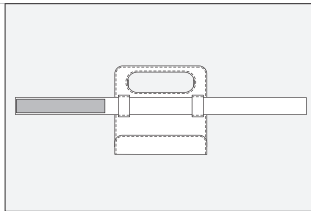
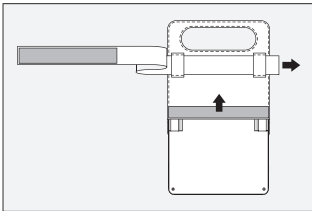

To access the Setup Menu, press the **Setup Button**.

LANGUAGE SETUP PAGE

General	Audio	Video	System
-- Language Setup Page --			
Tv Display	Wide		
Lcd Mode	Wide		
OSD Language	Eng		
Screen Saver	On		
Exit Setup			

AUDIO SETUP PAGE

General	Audio	Video	System
-- Audio Setup Page --			
Downmix			
Exit Setup			

Downmixing is an advanced feature that allows users to manipulate audio output from the device, to produce a lower number of distinct audio channels.

VIDEO SETUP PAGE

General	Audio	Video	System
-- Video Setup Page --			
Sharpness	Low		
Brightness	00		
Contrast	00		
Hue	00		
Saturation	00		
Exit Setup			

SYSTEM SETUP PAGE

General	Audio	Video	System
-- System Page --			
Audio	Eng		
Subtitle	Eng		
Disc Menu	Eng		
Default			
Exit Setup			

The *Audio Language*, *Subtitle Language*, and *Disc Menu Language* are all dependent on what the loaded DVD offers. Please lift the CD door up or make sure there is no disc in the tray first, then press SETUP button to setup the SYSTEM.

UNIT CONTROL LOCATIONS

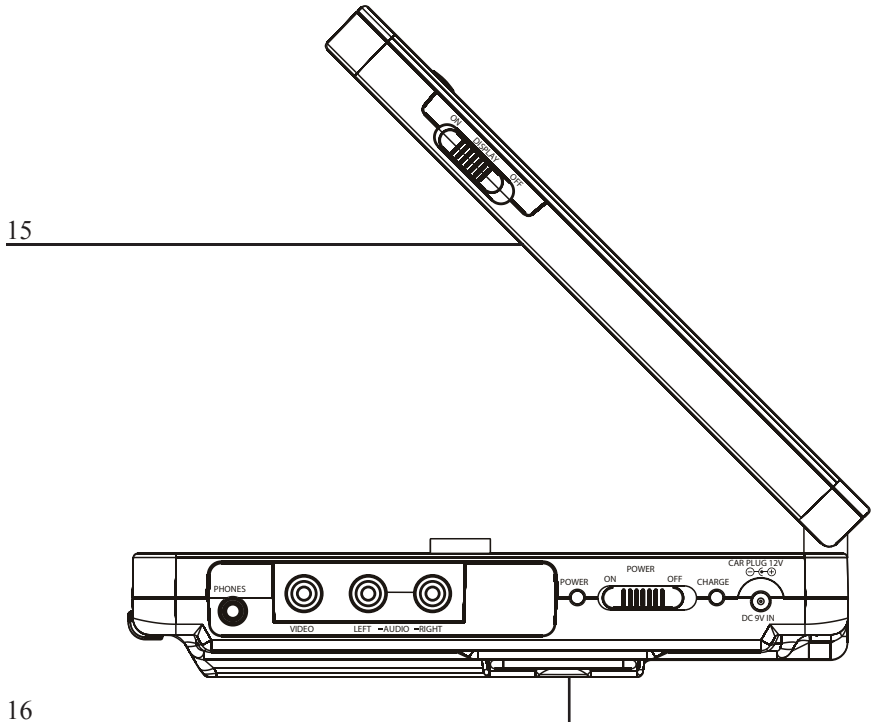
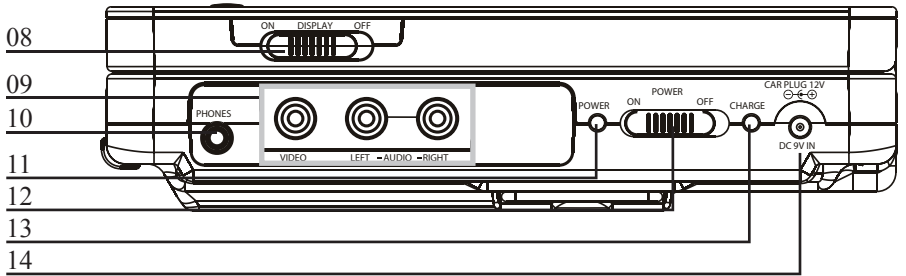
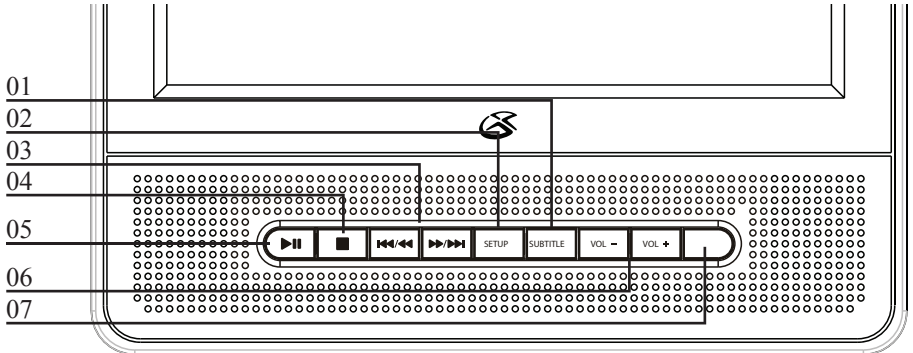

01. Subtitle Button

Press the Subtitle Button to turn subtitles on for the loaded DVD.

02. Setup Button

Press the Setup Button to enter the setup menu.

03. Skip/Search Buttons

Press the Skip/Search Buttons to skip through DVD chapters or CD tracks.

Press and hold the Skip/Search Buttons to rewind and fast forward through DVD chapters or CD tracks.

04. Stop Button

Press the Stop Button to stop a DVD or CD during play.

05. Play/Pause Button

Press the Play/Pause Button to play or pause a loaded DVD or CD.

06. Volume Buttons

Press the Volume Buttons to adjust the volume of the unit.

07. Infrared Receiver for the Remote**08. Display Power Switch**

Adjust the Display Power Switch to turn the display off and on.

09. Composite Video Output**Left/Right Audio Output**

Use the Composite Video Output to send video from the main unit to the included screen.

Use the Left/Right Audio Output to send audio from the main unit to the included screen.

10. Headphone Jack

Use the Headphone Jack to connect a set of earbuds or headphones to the unit.

11. Power Indicator

The power indicator will illuminate when the unit is powered on.

12. Power Switch

Adjust the Power Switch to turn the unit off and on.

13. Charge Indicator

The Charge Indicator will blink when the unit is charging..

The Charge Indicator will remain lit when the unit is fully charged.

14. DC Power Input

Use the DC Power Input to connect the unit to a power source.

15. DVD Door

Open the DVD Door to load a DVD or CD into the unit.

16. Headrest Strap Connection

Use the Headrest Strap Connections to securely connect the headrest strap to the unit.

UNIT CONTROL LOCATIONS

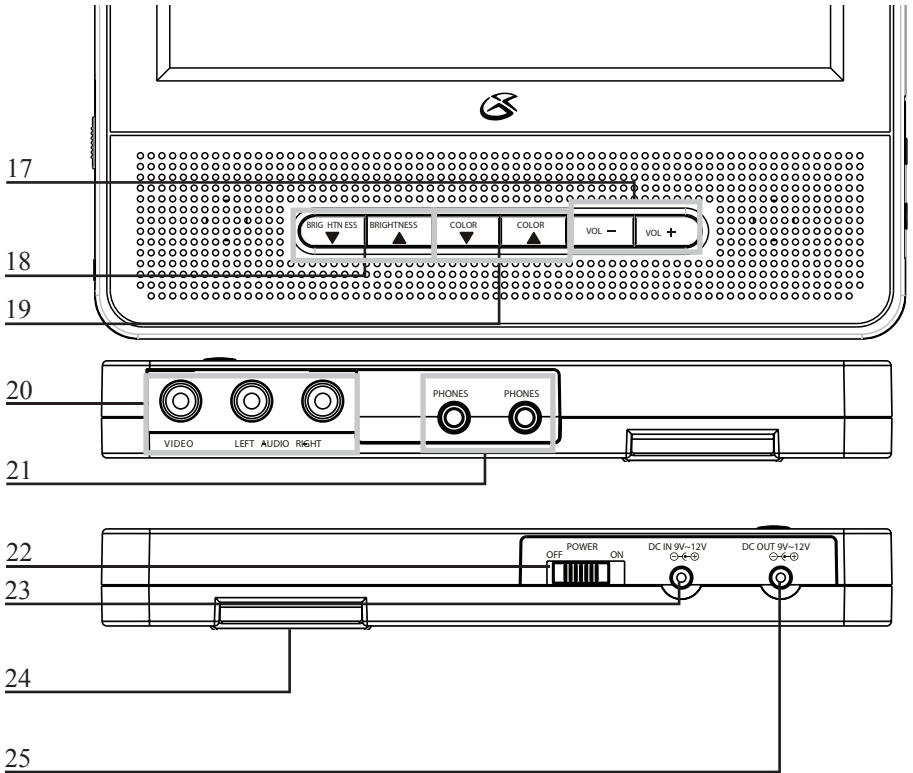

17. Volume Buttons

Press the Volume Buttons to adjust the volume of the unit.

18. Brightness Controls

Use the Brightness Controls to adjust the brightness of the screen.

19. Color Controls

Use the Color Controls to adjust the color of the screen.

**20. Composite Video Input
Left/Right Audio Input**

Use the Composite Video Input to receive video from the main unit.

Use the Left/Right Audio Input to receive audio from the main unit.

21. Headphone Jacks

Use the Headphone Jacks to connect a set of earbuds or headphones to the unit.

22. Power Switch

Adjust the Power Switch to turn the screen off and on.

23. DC Power Input

Use the DC Power Input to connect the unit to a power source.

24. Headrest Strap Connection

Use the Headrest Strap Connections to securely connect the headrest strap to the unit.

25. DC Power Output

Use the DC Power Output to send power from the screen to the main unit.

The DC Power Input must be connected to a power source for the DC Power Output to power the main unit.

REMOTE CONTROL LOCATIONS

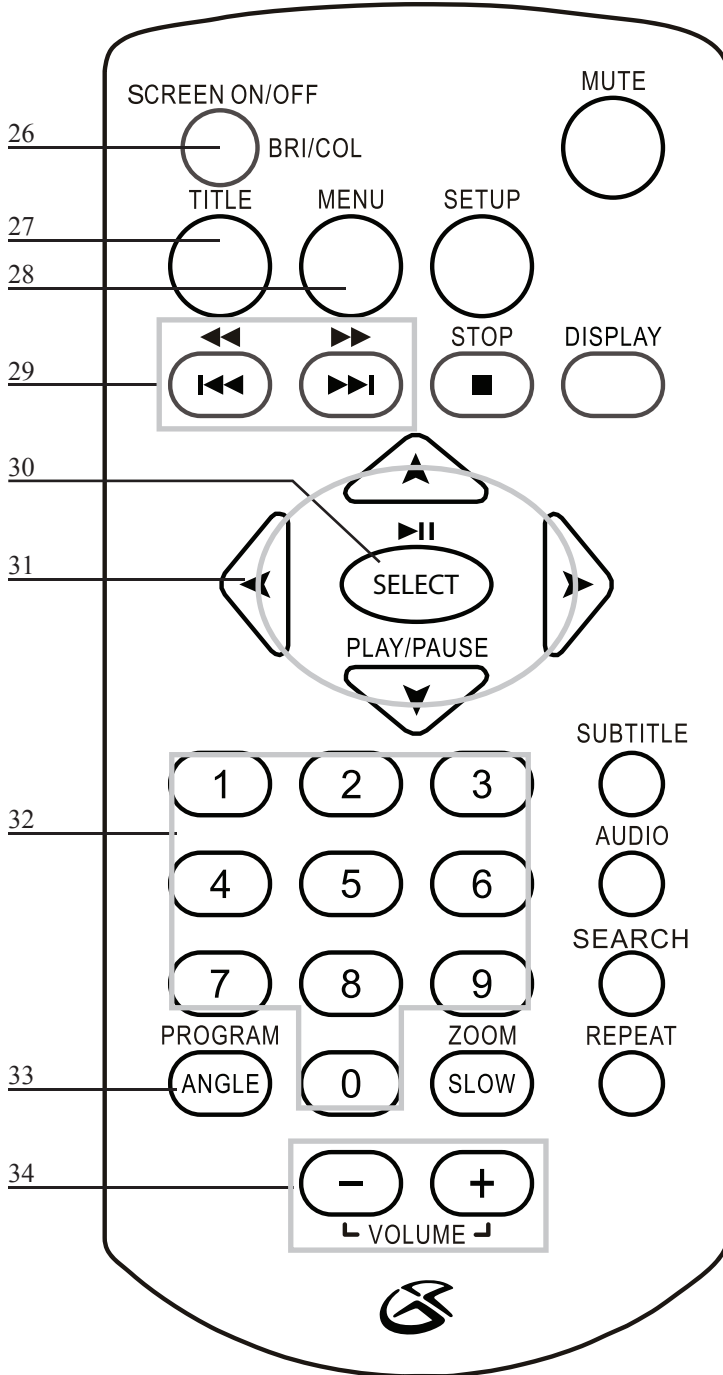

The remote control will control the main unit only, it will not control the included secondary screen.

26. Screen On/Off Button

Brightness/Color Button

Press and hold the Screen On/Off Button to turn the display on the main unit off and on.

Press the Brightness/Color Button to access the brightness and color adjustments on the main unit.

After accessing the brightness and color adjustments, press the directional buttons to adjust the brightness and color.

27. Title Button

Press the Title Button to return to the title menu on a loaded DVD.

28. Menu Button

Press the Menu Button to return to the menu on a loaded DVD.

29. Skip/Search Buttons

Press the Skip/Search Buttons to skip through DVD chapters or CD tracks.

Press and hold the Skip/Search Buttons to rewind and fast forward through DVD chapters or CD tracks.

30. Play/Pause Button

Select Button

Press the Play/Pause Button to play or pause a loaded DVD or CD.

Press the Select Button to make selections on the unit's display.

31. Directional Buttons

Use the Directional Buttons to navigate the unit's display.

32. Number Keypad

33. Program/Angle Button

Press the Program Button to program a loaded DVD or CD.

Press and hold the Angle Button to access the angle feature of a loaded DVD.

Please note, not all DVD's support this feature.

34. Volume Buttons

Press the Volume Buttons to adjust the volume of the main unit.

REMOTE CONTROL LOCATIONS

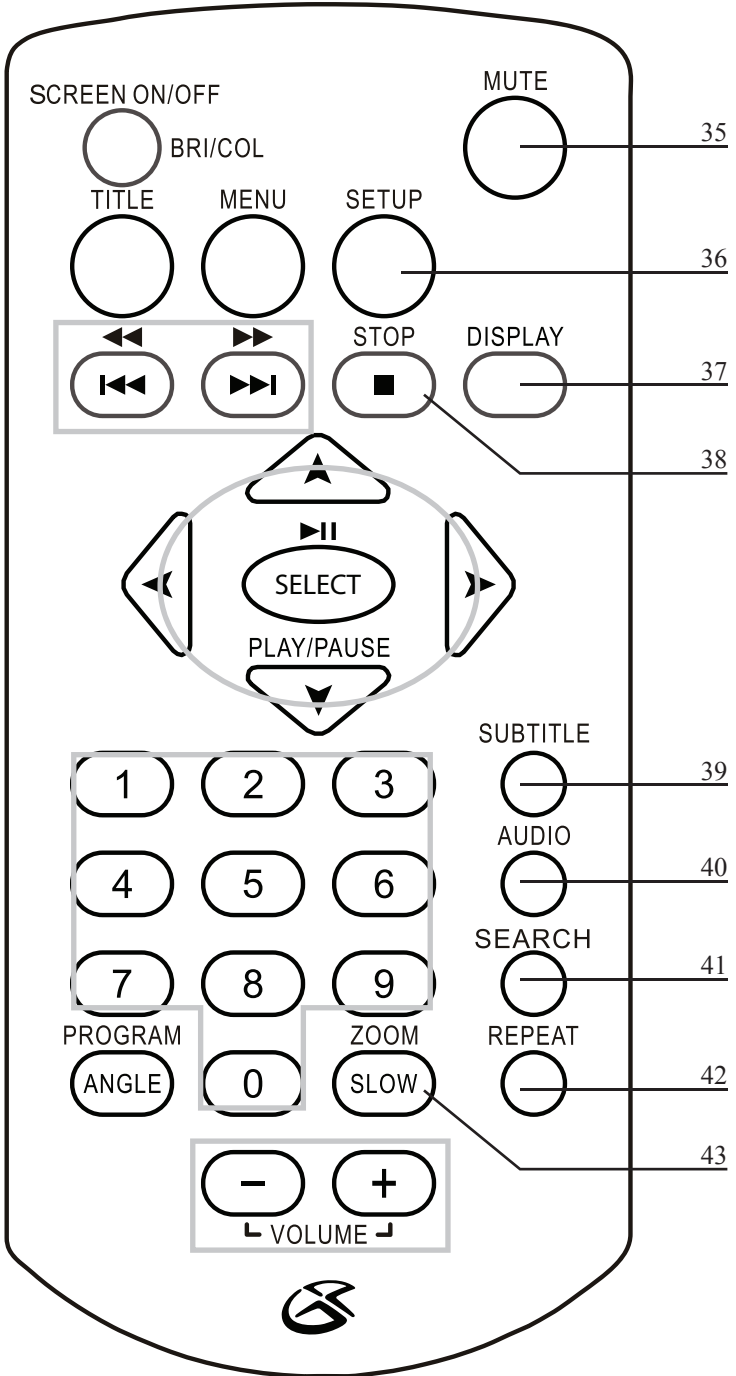

The remote control will control the main unit only, it will not control the included secondary screen.

35. Mute Button

Press the Mute Button to reduce the volume of the main unit entirely.

36. Setup Button

Press the Setup Button to access the setup menu.

37. Display Button

Press the Display Button to view the on-screen-display while a DVD is playing.

38. Stop Button

Press the Stop Button to stop a DVD or CD during play.

39. Subtitle Button

Press the Subtitle Button to turn subtitles on for the loaded DVD.

40. Audio Button

Press the Audio Button to adjust the audio language of a loaded DVD.

41. Search Button

Press the Search Button to search for a specific location on a loaded DVD.

42. Repeat Button

Press the Repeat Button to repeat a chapter, title, entire DVD, or to repeat from point A to point B.

See the "Playing a DVD" or "Playing a CD" operation to better understand how to use the Repeat Button.

43. Zoom/Slow Button

Press the Zoom Button to zoom in on a loaded DVD.

Press and hold the Slow Button to view the loaded DVD in slow motion.

GREEN INITIATIVE

Environmental Commitment to ‘Protect for Today and Sustain for Tomorrow’

2009 marks the official launch of DPI, Inc.’s corporate campaign for a greener and cleaner world. DPI and its four brands, iLive, WeatherX, Capri, and GPX, are building upon environmental initiatives introduced at all of their facilities to help formulate and sustain significant and important conservation efforts within its manufacturing and marketing communities. In addition to targeting and selecting energy efficient product features, and structuring ‘green office’ procedures, other initial program efforts include:

- Reduction of all packaging sizes
- Recyclable plastics for clamshell packages, with a plan to eventually replace plastic with recyclable paper
- Recycled fiber board in place of the polyfoam in packing boxes
- Recycled plastics in place of the virgin material in product construction

INTERNATIONAL SUPPORT

To download this User’s Guide in English, Spanish, or French, visit the support section at www.gpx.com.

Para transferir esta guía de usuario en inglés, español, o francés, visite la sección de la ayuda en www.gpx.com.

Pour télécharger ce guide de l’utilisateur en anglais, espagnol, ou français, visitez la section de soutien chez www.gpx.com.

SERVICE INFORMATION

Address: 2116 Carr Street, St. Louis MO, 63106

Phone: 1-314-621-2881

Fax: 1-314-588-1805

Email: prodinfo@gpx.com

Parts Email: partsinfo@dpi-global.com

Website: www.gpx.com

Free Manuals Download Website

<http://myh66.com>

<http://usermanuals.us>

<http://www.somanuals.com>

<http://www.4manuals.cc>

<http://www.manual-lib.com>

<http://www.404manual.com>

<http://www.luxmanual.com>

<http://aubethermostatmanual.com>

Golf course search by state

<http://golfingnear.com>

Email search by domain

<http://emailbydomain.com>

Auto manuals search

<http://auto.somanuals.com>

TV manuals search

<http://tv.somanuals.com>