



USER'S GUIDE
V:1630-0708-10



TD2220

22" Class HDTV with DVD

For the most up-to-date version of this User's Guide, go to www.gpx.com

Warnings and Precautions

- **CAUTION:** TO PREVENT ELECTRIC SHOCK, MATCH WIDE BLADE OF PLUG TO WIDE SLOT, FULLY INSERT.
- **WARNING:** To reduce the risk of fire or electric shock, do not expose this apparatus to rain or moisture.
- **AVERTISSEMENT:** Pour réduire le risque d'incendie ou de choc électrique, ne pas exposer cet appareil sous la pluie et l'humidité.
- **CAUTION:** Use of controls or adjustments or performance of procedures other than those specified may result in hazardous radiation exposure.
- **WARNING:** Changes or modifications to this unit not expressly approved by the party responsible for compliance could void the user's authority to operate the equipment.
- **WARNING:** Do not place the unit on top of any soft, porous, or sensitive surfaces to avoid damaging the surface. Use a protective barrier between the unit and surface to protect the surface.
- **WARNING:** Use of this unit near fluorescent lighting may cause interference regarding use of the remote. If the unit is displaying erratic behavior move away from any fluorescent lighting, as it may be the cause.
- **CAUTION:** Danger of explosion if battery is incorrectly replaced. Replace only with the same or equivalent type.
- **PRÉCAUTION:** *Danger d'explosion si les piles sont remplacées de façon incorrect. Remplacer les piles seulement par le même type de pile ou l'équivalent.*
- **WARNING:** There is a danger of explosion if you attempt to charge standard Alkaline batteries in the unit. Only use rechargeable NiMH batteries.
- **WARNING:** The remote control's button cell battery contains mercury. Do not put in the trash, instead recycle or dispose of as hazardous waste

- **WARNING:** Lithium batteries, like all rechargeable batteries are recyclable and should be recycled or disposed of in normal household waste. Contact your local government for disposal or recycling practices in your area. They should never be incinerated since they might explode.
- **WARNING:** Shock hazard - Do Not Open.
- **AVIS:** *RISQUE DE CHOC ÉLECTRIQUE - NE PAS OUVRIR*

Mains plug is used as disconnect device and it should remain readily operable during intended use. In order to disconnect the apparatus from the mains completely, the mains plug should be disconnected from the mains socket outlet completely.

La prise du secteur est utilisé pour déconnecter le système.

La prise du secteur ne doit pas être obstruée ou doit être facilement accessible pendant son utilisation. Pour être complètement déconnecté de l'alimentation d'entrée, la prise doit être débranchée du secteur.

Do not mix old and new batteries.

Do not mix alkaline, standard (carbon-zinc), or rechargeable (ni-cad, ni-mh, etc) batteries.

No mezcle baterías viejas y nuevas.

No mezcle baterías alcalinas, estándar (carbono-zinc) o recargables (ni-cad, ni-mh, etc.).



WARNING: TO REDUCE THE RISK OF ELECTRIC SHOCK, DO NOT REMOVE COVER (OR BACK). NO USER-SERVICEABLE PARTS INSIDE. REFER SERVICING TO QUALIFIED SERVICE PERSONNEL.



The lightning flash with arrowhead symbol, within an equilateral triangle, is intended to alert the user to the presence of uninsulated "dangerous voltage" within the product's enclosure that may be of sufficient magnitude to constitute a risk of electric shock to persons.



The exclamation point within an equilateral triangle is intended to alert the user to the presence of important operating and maintenance (servicing) instructions in the literature accompanying the appliance.



This product utilizes a Class 1 laser to read Compact Discs. This laser Compact Disc Player is equipped with safety switches to avoid exposure when the CD door is open and the safety interlocks are defeated. Invisible laser radiation is present when the CD Player's lid is open and the system's interlock has failed or been defeated. It is very important that you avoid direct exposure to the laser beam at all times. Please do not attempt to defeat or bypass the safety switches.

Important Safety Instructions

1. Read these Instructions.
2. Keep these Instructions.
3. Heed all Warnings.
4. Follow all instructions.
5. Do not use this apparatus near water.
6. Clean only with a dry cloth.
7. Do not block any ventilation openings. Install in accordance with the manufacturer's instructions.
8. Do not install near any heat sources such as radiators, heat registers, stoves, or other apparatus (including amplifiers) that produce heat.
9. Do not defeat the safety purpose of the polarized or grounding - type plug. A polarized plug has two blades with one wider than the other. A grounding type plug has two blades and a third grounding prong. The wide blade or the third prong are provided for your safety. When the provided plug does not fit into your outlet, consult an electrician for replacement of the obsolete outlet.
10. Protect the power cord from being walked on or pinched particularly at plugs, convenience receptacles, and the point where they exit from the apparatus.
11. Only use attachments/accessories specified by the manufacturer.



12. Use only with a cart, stand, tripod, bracket, or table specified by the manufacturer, or sold with the apparatus. When a cart is used, use caution when moving the cart/apparatus combination to avoid injury from tip-over.

13. Unplug this apparatus during lightning storms or when unused for long periods of time.
14. Refer all servicing to qualified service personnel. Servicing is required when the apparatus has been damaged in any way, such as power-supply cord or plug is damaged, liquid has been spilled or objects have fallen into the apparatus, the apparatus has been exposed to rain or moisture, does not operate normally, or has been dropped.

FCC Warnings

NOTE: This equipment has been tested and found to comply with the limits for a Class B digital device, pursuant to Part 15 of the FCC Rules. These limits are designed to provide reasonable protection against harmful interference in a residential installation. This equipment generates, uses, and can radiate radio frequency energy and, if not installed and used in accordance with the instructions, may cause harmful interference to radio communications. However, there is no guarantee that interference will not occur in a particular installation. If this equipment does cause harmful interference to radio or television reception, which can be determined by turning the equipment off and on, the user is encouraged to try to correct the interference by one or more of the following measures:

- Reorient or relocate the receiving antenna.
- Increase the separation between the equipment and receiver.
- Connect the equipment into an outlet on a circuit different from that to which the receiver is connected.
- Consult the dealer or an experienced radio/TV technician for help.

Additional Warnings

- The apparatus shall not be exposed to dripping or splashing and that no objects filled with liquids, such as vases, shall be placed on apparatus.
L'appareil ne doit pas être exposé aux écoulements ou aux éclaboussures et aucun objet ne contenant de liquide, tel qu'un vase, ne doit être placé sur l'objet.
- Main plug is used as disconnect device and it should remain readily operable during intended use. In order to disconnect the apparatus from the mains completely, the mains plug should be disconnected from the mains socket outlet completely.
La prise du secteur ne doit pas être obstruée ou doit être facilement accessible pendant son utilisation. Pour être complètement déconnecté de l'alimentation d'entrée, la prise doit être débranchée du secteur.
- Battery shall not be exposed to excessive heat such as sunshine, fire or the like.
Les piles ne doivent pas être exposées à de forte chaleur, tel qu'à la lumière du soleil, au feu ou autres choses de semblable.
- Caution marking is located at the rear or back of the apparatus.
Attention marquage est situé à l'arrière ou à l'arrière de l'appareil
- The marking information is located at the rear or back of apparatus.
Les informations de marquage est situé à l'arrière ou à l'arrière de l'appareil.



This symbol indicates that this product incorporates double insulation between hazardous mains voltage and user accessible parts.

This product incorporates copyright protection technology that is protected by U.S. patents and other intellectual property rights. Use of this copyright protection technology must be authorized by Rovi Corporation, and is intended for home and other limited viewing uses only unless otherwise authorized by Rovi Corporation. Reverse engineering and disassembly are prohibited.

22" Class HDTV with DVD

Features

- 21.6" LCD display
- ATSC/NTSC tuner
- Electronic program guide
- Aspect ratio: 16:9
- Resolution: 1366 x 768
- Viewing angle: 170 (H) x 160 (V)
- Contrast: 1000:1
- Brightness: 350cd/m²
- Response time: <8ms
- Color: 16.7 million
- Multi-language OSD: English, French, Spanish
- Sleep timer
- Auto-play DVD player
- DVD player: DVD, DVD±R/RW
- CD player: CD, CD-R/RW, JPEG CDs
- SD memory card reader
- USB port, 2.0 high speed
- Composite video input
- RCA audio input
- RF input
- VGA/PC input
- HDMI input
- Built-in speakers
- Remote control: requires 2, AAA size, batteries (included)
- AC power input: requires an AC power cable (included)

Included

- Detachable stand
- Remote control: requires 2, AAA size, batteries (included)
- AC power cable

TABLE OF CONTENTS

Warnings and Precautions	. 2
Important Safety Instructions	. 3
• FCC Warnings	
• Additional Warnings	
22" Class HDTV with DVD	. 4
• Features	
• Included	
Introduction	. 6
Setup	. 8
• Power	
• Remote	
• TV Stand	
Television Setup	. 9
• Connecting a TV Antenna	
• Connecting a Set-Top Box	
• Connecting Basic Cable	
Television	10
• Auto Scanning for Channels	
• Channel List View	
• Adding Favorites	
• Viewing Favorites	
• Parental Controls (V-Chip)	
Television	11
• Setting the Clock	
• Television Menu	
DVD and CD	12
• Loading a DVD or CD	
• Playing a DVD or CD	
• Programming a DVD or CD	
• DVD Setup Menu	
USB Port and Memory Card Reader	13
• Connecting a Memory Card	
• Using a Connected Memory Card	
• Connecting a USB Thumb Drive	
• Using a Connected USB Thumb Drive	
Connecting Other Devices (Set-Top Box, Gaming Device, DVD Player, VCR, or PC)	14
• Connecting a Set-Top Box	
• Connecting a Gaming Device	
• Connecting a DVD Player or VCR	
• Connecting a Computer	
Company Information	16
• Green Initiative	
• International Support	
• Contact Information	

Introduction

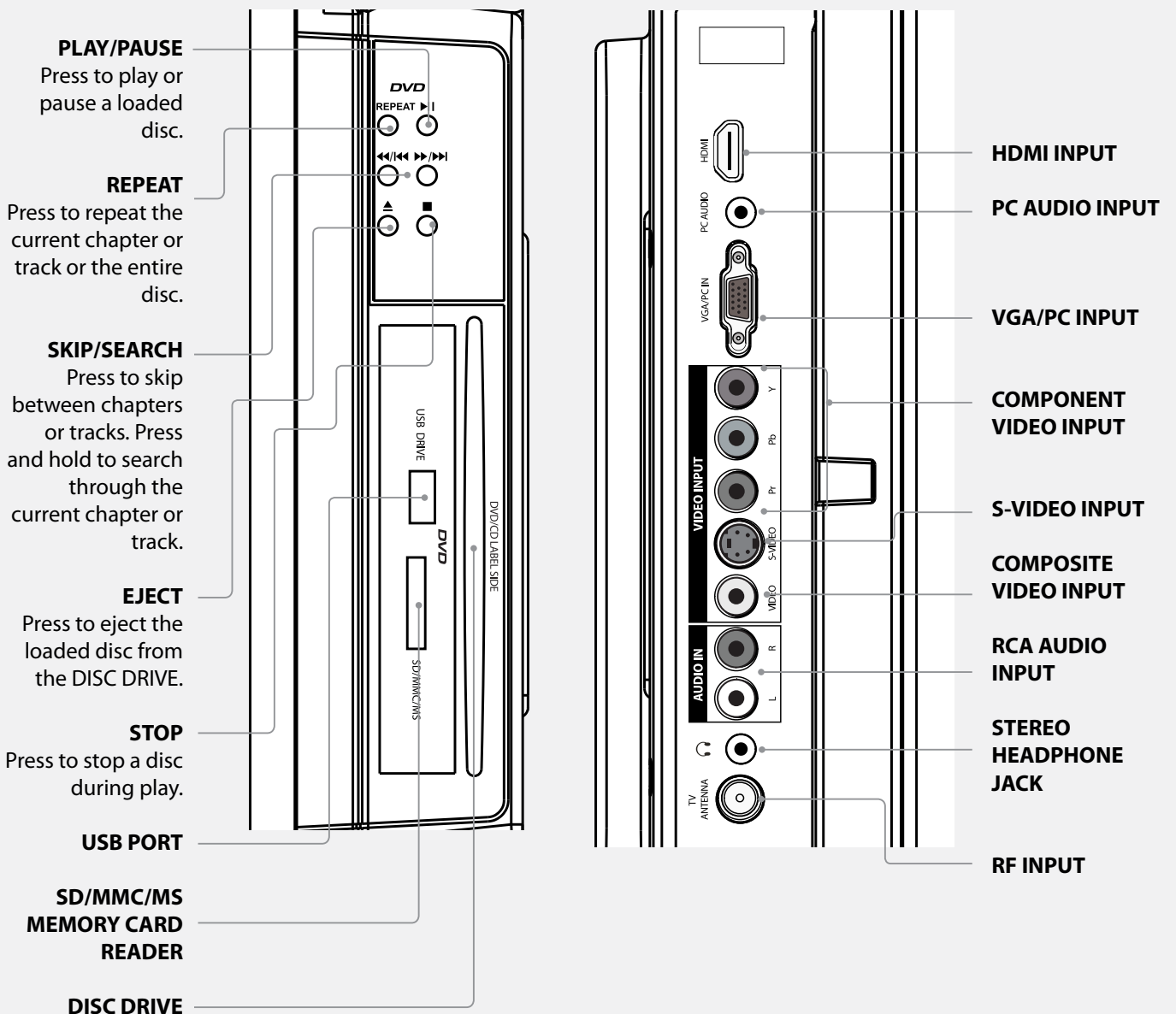
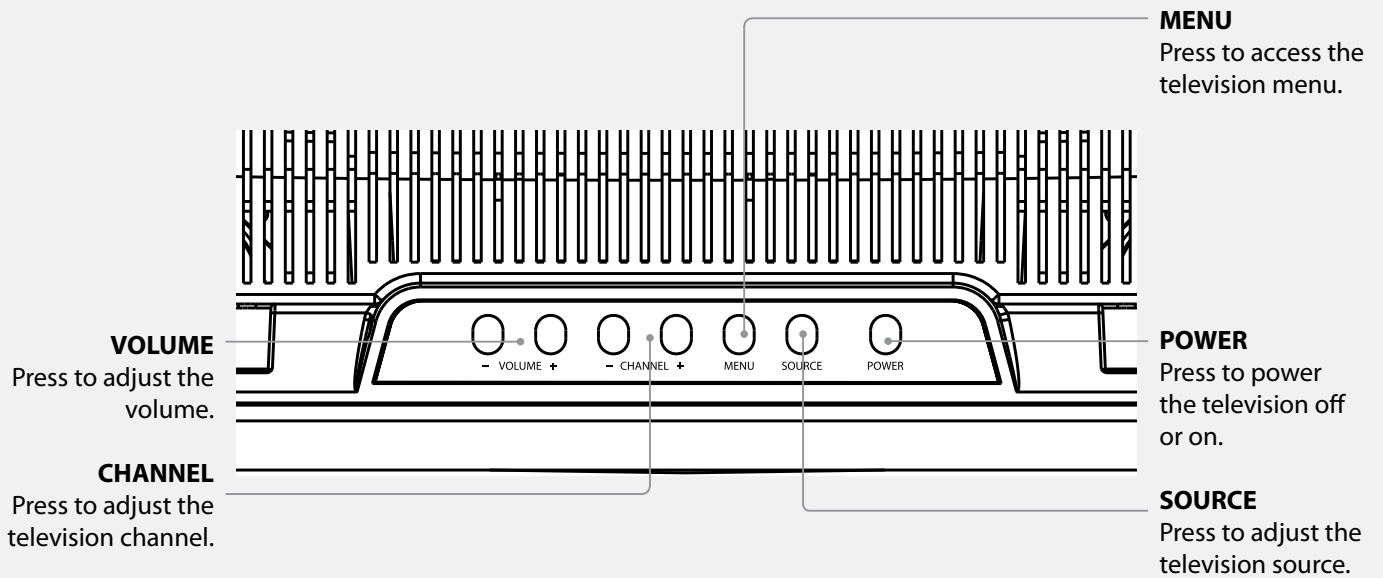

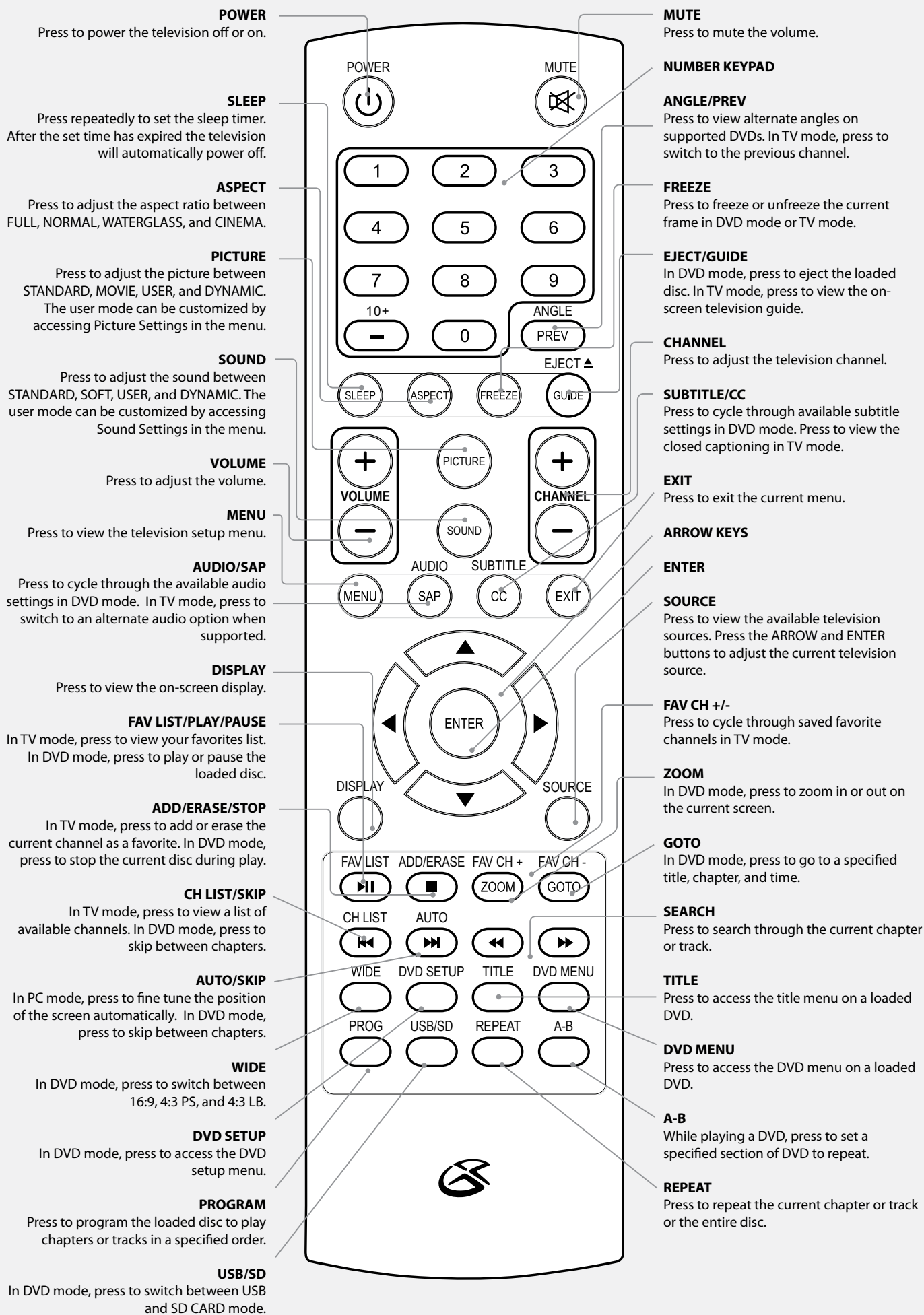

Setup

Power

AC power: requires an AC power cord (included).

Plug the included AC power cord into a standard AC power outlet to power the television.

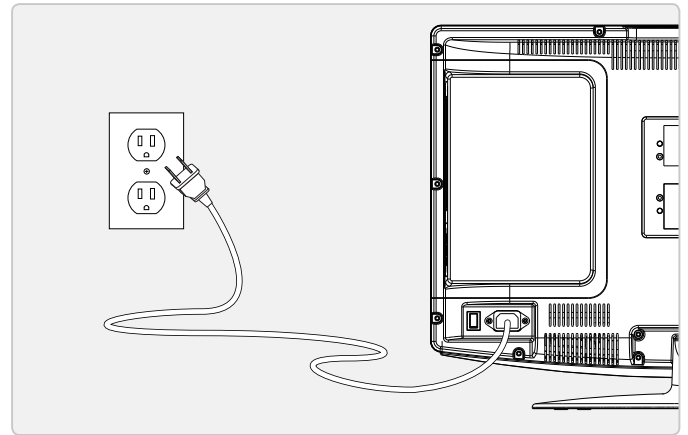

Remote

Requires 2, AAA size, batteries (included)

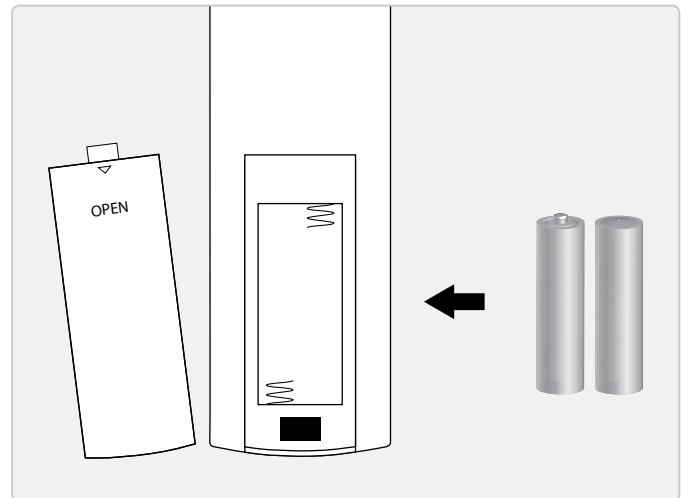

TV Stand

Requires TV stand and 3 screws (included). Use a philips-head screwdriver to tighten the screws. Using an power drill could damage the TV stand.

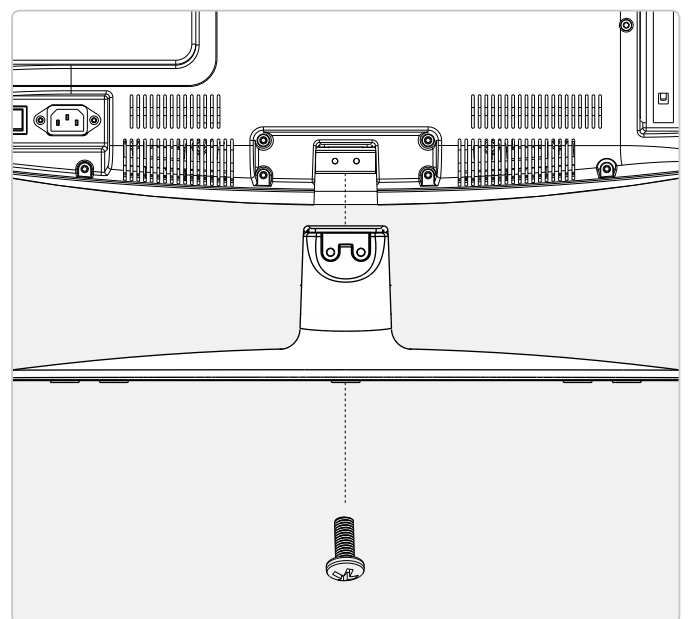
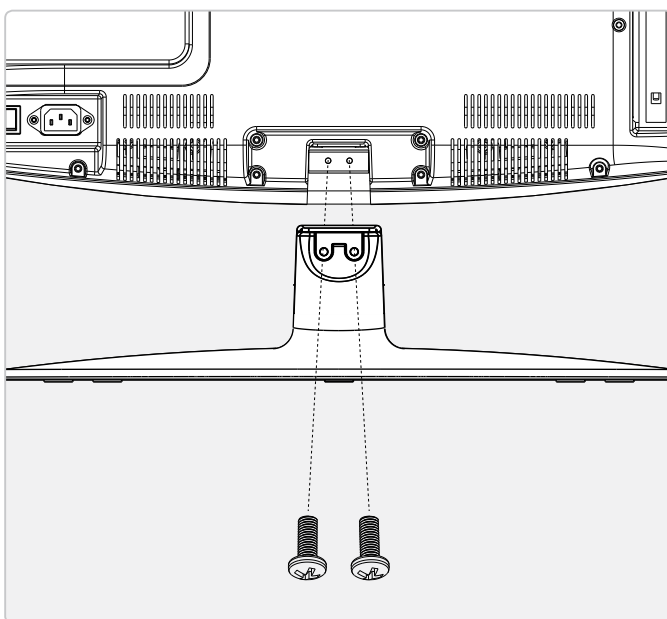

Connecting a TV Antenna

Requires a TV antenna (not included).

1. Connect a VHF, UHF, or HDTV antenna to the **RF INPUT** on the television.
2. Press the **SOURCE** button to switch to TV mode.
3. Press the **MENU** button to access the setup menu.
4. Press the **ARROW** (◀ ▶) buttons to highlight the CHANNEL icon. Press the **ENTER** button.
5. Press the **ARROW** (▼ ▲) buttons to highlight SIGNAL TYPE. Press the **ARROW** (◀ ▶) buttons to select AIR.
6. Press the **ARROW** (▼ ▲) buttons to highlight AUTO CHANNEL SEARCH. Press the **ENTER** button to begin scanning for available channels.

Connecting Basic Cable

Requires a cable connection.

1. Connect a cable to the **RF INPUT** on the television.
2. Press the **SOURCE** button to switch to TV mode.
3. Press the **MENU** button to access the setup menu.
4. Press the **ARROW** (◀ ▶) buttons to highlight the CHANNEL icon. Press the **ENTER** button.
5. Press the **ARROW** (▼ ▲) buttons to highlight SIGNAL TYPE. Press the **ARROW** (◀ ▶) buttons to select AIR.
6. Press the **ARROW** (▼ ▲) buttons to highlight AUTO CHANNEL SEARCH. Press the **ENTER** button to begin scanning for available channels.

Connecting a Set-Top Box

Requires a Set-Top Box (not included).

If your Set-Top Box has an HDMI Output:

- Connect the HDMI output on the Set-Top Box to the **HDMI INPUT** on the television using an HDMI cable (not included).

If your Set-Top Box has a Composite Video Output:

- Connect the video output on the Set-Top Box to the **COMPOSITE VIDEO INPUT** on the television using an A/V RCA cable (not included). Connect the audio output on the Set-Top Box to the **RCA AUDIO INPUT** on the television.

If your Set-Top Box has a Component Video Output:

- Connect the component video output on the Set-Top Box to the **COMPONENT VIDEO INPUT** on the television using a component RCA cable (not included). Connect the audio output on the Set-Top Box to the **RCA AUDIO INPUT** on the television.

After connecting your Set-Top Box:

- Press the **SOURCE** button to switch to YPBPR, S-VIDEO, AV, or HDMI to match the connection used.

Television

Auto Scanning for Channels

The Auto Channel Scan must be run before any channels can be viewed on the television.

1. Press the **SOURCE** button to switch to TV mode.
2. Press the **MENU** button to access the setup menu.
3. Press the **ARROW** (◀ ▶) buttons to highlight the CHANNEL icon. Press the **ENTER** button.
4. Press the **ARROW** (▼ ▲) buttons to highlight SIGNAL TYPE. Press the **ARROW** (◀ ▶) buttons to select AIR.
5. Press the **ARROW** (▼ ▲) buttons to highlight AUTO CHANNEL SEARCH. Press the **ENTER** button to begin scanning for available channels.

Channel List View

1. Press the **SOURCE** button to switch to TV mode.
2. Press the **CH LIST** button, on the remote, to view a list of available channels.

Unless you are using a Set-Top Box, you must auto scan for channels before being able to view channels in list view.

Adding Favorites

1. Press the **SOURCE** button to switch to TV mode.
2. Press the **CHANNEL** buttons to select the desired TV channel.
3. Press the **ADD/ERASE** button to add or erase the current channel as a favorite.

Viewing Favorites

1. Press the **SOURCE** button to switch to TV mode.
2. Press the **FAV LIST** button to view a list of your saved favorites.

Parental Controls (V-Chip)

1. Press the **SOURCE** button to switch to TV mode.
2. Press the **MENU** button.
3. Press the **ARROW** (◀ ▶) buttons, highlight PARENTAL, and press the **ENTER** button.
4. The default passcode for the parental lock is: **0 0 0 0**
5. Enter the passcode to access the PARENTAL CONTROL preferences.
6. From this menu, you can lock specific ratings from the United States rating system or the Canadian rating system by accessing the V-CHIP settings. You can also lock the buttons on the television or lock specific sources from access.

Setting the Clock

1. Press the **MENU** button to access the setup menu.
2. Press the **ARROW** (◀ ▶) buttons to highlight the SETUP icon. Press the **ENTER** button.
3. Press the **ARROW** (▼ ▲) buttons to highlight CLOCK. Press the **ENTER** button.
4. Press the **ARROW** (▼ ▲) buttons to highlight TIME ZONE. Press the **ARROW** (◀ ▶) buttons to select your current time zone.
5. Press the **ARROW** (▼ ▲) buttons to highlight AUTO CLOCK. Press the **ARROW** (◀ ▶) buttons to turn auto clock off and on.

When the correct time zone is set, auto clock will automatically set your clock and date for you.

6. To set the time and date manually, turn auto clock off, highlight SETUP TIME, and use the **ARROW** buttons to manually set the time and date.

Television Menu

Press the **MENU** button to access the TV menu.
Press the **EXIT** button to exit the TV menu.

Picture

Picture Settings
Screen Settings
PC Settings
Color Temperature
Advanced Picture Settings

Sound

Sound Settings
Surround Mode
Analog Sound
Digital Sound
Other Settings

Channel

Channel List
Favorite List
Channel Setting
Signal Type
Auto Channel Search

Parental

Lock Parental Control
V-Chip
Change Password
Front Panel Lock
Source Lock

Setup

Closed Caption
Menu Language
Clock

Others

Blue Back
No Signal Power Off
No Operation Power Off
All Reset
Audio Only

DVD and CD

Loading a DVD or CD

1. Gently insert a DVD or CD into the slot-load disc drive, with the label side of the DVD or CD facing the back of the television.

Once a DVD or CD is loaded into the television, the TV will automatically switch to DVD mode.

Playing a DVD or CD

1. Follow the instructions for [Loading a DVD or CD](#).
2. After the DVD or CD is loaded, it will begin playing automatically.

*If the DVD or CD does not begin playing automatically, press the **PLAY/PAUSE** button to begin playing the loaded disc.*

Programming a DVD or CD

1. While a DVD or CD is playing, press the **PROGRAM** button on the remote.
2. Using the **NUMBER KEYPAD** enter in the title (T) and chapters (C), or tracks in the order you want them to play.
3. Highlight the on-screen PLAY button using the **ARROW** buttons and press the **ENTER** button.
4. The programmed titles and chapters, or tracks will now play in the designated order.
5. To cancel a program, press the **PROGRAM** button, highlight the on-screen CLEAR button using the **ARROW** buttons, and press the **ENTER** button.

DVD Setup Menu

In DVD mode, press the **DVD SETUP** button to access the DVD setup menu. Press the **DVD SETUP** button to exit the DVD setup menu.

System Setup

TV System
Screen Saver
TV Type
Power Resume
Default
Exit Setup

Language Setup

OSD Language
Audio Language
Subtitle Language
Menu Language
Exit Setup

Audio Setup

Key
Exit Setup

Digital Setup

Dynamic Range
Dual Mono
Exit Setup

USB Port and Memory Card Reader

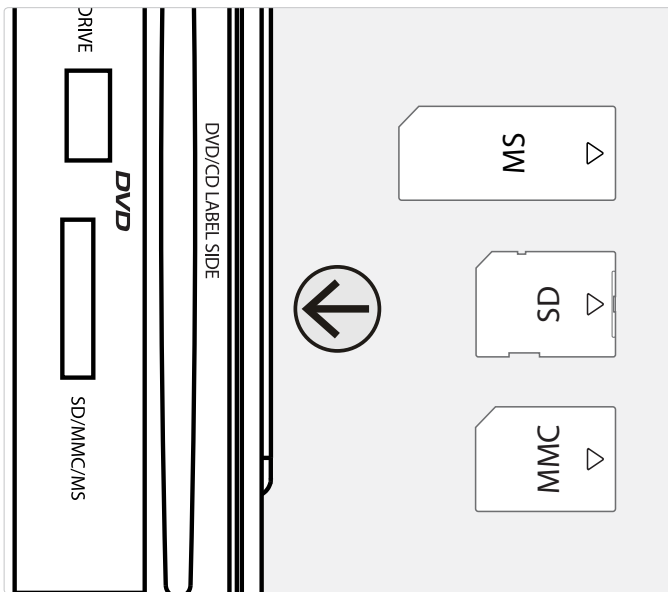

Connecting a Memory Card

1. Load an SD, MS, or MMC memory card into the **MEMORY CARD READER** as shown in the image to the right.

Using a Connected Memory Card

1. Follow the instructions for [Connecting an SD or MMC card](#).
2. Press the **SOURCE** button to switch to DVD mode.
3. Press the **USB/SD** button on the remote to switch to the connected memory card.
4. Use the **ARROW** and **ENTER** buttons to select and play content from the connected memory card.

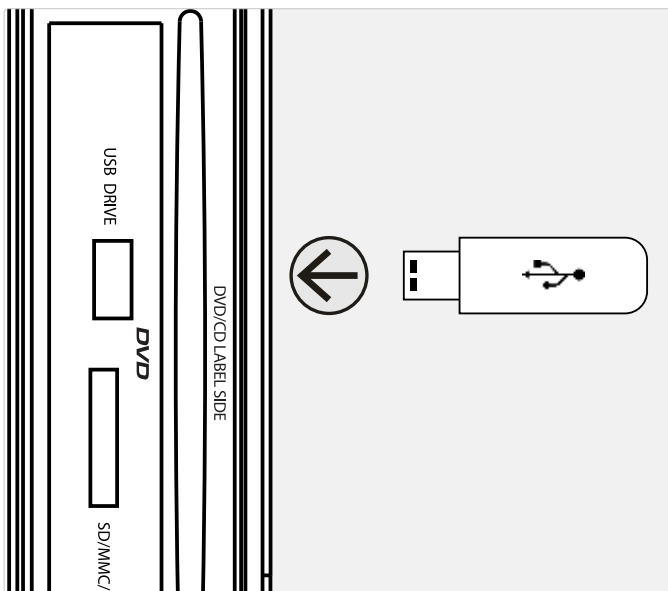

Connecting a USB Thumb Drive

1. Load a USB thumb drive into the **USB PORT** as shown in the image to the right.

Using a Connected USB Thumb Drive

1. Follow the instructions for [Connecting a USB thumb drive](#).
2. Press the **SOURCE** button to switch to DVD mode.
3. Press the **USB/SD** button on the remote to switch to the connected USB thumb drive.
4. Use the **ARROW** and **ENTER** buttons to select and play content from the connected USB thumb drive.

Connecting Other Devices (Set-Top Box, Gaming Device, DVD Player, VCR, or PC)

Connecting a Set-Top Box

- You will need: a set-top box, s-video and RCA stereo cables or composite and RCA stereo cables or component and RCA stereo cables or an HDMI cable. (not included)
- Connect the set-top box's *audio* and *video outputs* to the corresponding audio and video inputs on the television.
- Power the television on and press the **SOURCE** button to switch to the connected input. (AV (composite), YPbPr (component), S-VIDEO, or HDMI)

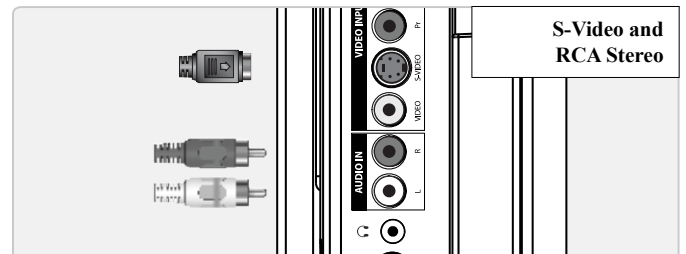
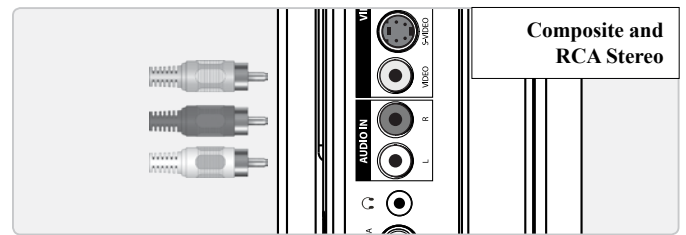

Connecting a Gaming Device

- You will need: a gaming device, s-video and RCA stereo cables or composite and RCA stereo cables or component and RCA stereo cables or an HDMI cable. (not included)
- Connect the gaming device's *audio* and *video outputs* to the corresponding audio and video inputs on the television.
- Power the television on and press the **SOURCE** button to switch to the connected input. (AV (composite), YPbPr (component), S-VIDEO, or HDMI)

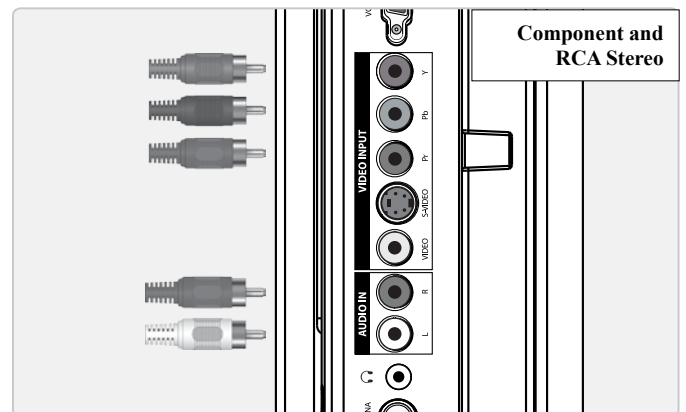

Connecting a DVD Player or VCR

- You will need: a DVD player or VCR, s-video and RCA stereo cables or composite and RCA stereo cables or component and RCA stereo cables or an HDMI cable.
- Connect the DVD player or VCR's *audio* and *video outputs* to the corresponding audio and video inputs on the television.
- Power the television on and press the **SOURCE** button to switch to the connected input. (AV (composite), YPbPr (component), S-VIDEO, or HDMI)

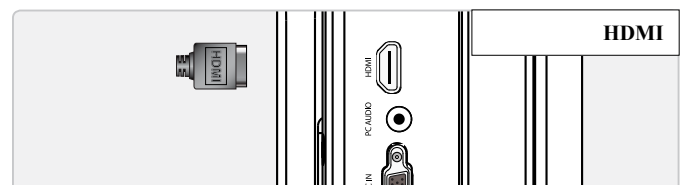

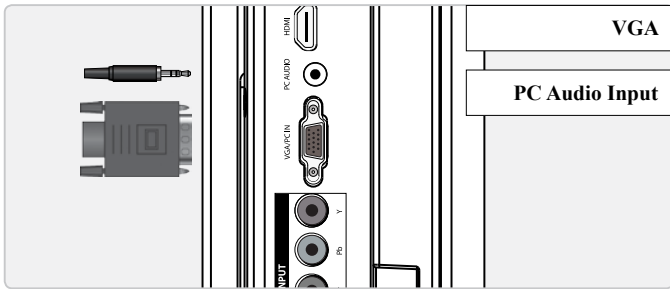

Connecting a Computer

- You will need: a PC with a VGA output, and a VGA cable. (not included)
- Connect the computer's *VGA output* to the **VGA/PC INPUT** on the television.
- Power the television on and press the **SOURCE** button to switch to the *VGA Mode*.
- Audio from the connected PC can be input to the television through the TV's **PC AUDIO INPUT** by using a 3.5mm audio cable (not included).

Company Information

Green Initiative



Environmental Commitment to 'Protect for Today and Sustain for Tomorrow'

2009 marked the official launch of DPI, Inc.'s corporate campaign for a greener and cleaner world. DPI is building upon environmental initiatives introduced at all of their facilities to help formulate and sustain significant and important conservation efforts within its manufacturing and marketing communities. In addition to targeting and selecting energy efficient product features, and structuring 'green office' procedures, other initial program efforts include:

- Reduction of all packaging sizes
- Recyclable plastics for clamshell packages, with a plan to eventually replace plastic with recyclable paper
- Recycled fiber board in place of the polyfoam in packing boxes
- Recycled plastics in place of the virgin material in product construction

International Support

To download this User's Guide in English, Spanish, or French, visit the support section at www.gpx.com.

Para transferir esta guía de usuario en inglés, español, o francés, visite la sección de la ayuda en www.gpx.com.

Pour télécharger ce guide de l'utilisateur en anglais, espagnol, ou français, visitez la section de soutien chez www.gpx.com.

Contact Information

Phone:

1-888-999-4215

Email:

prodinfo@gpx.com

Parts Email:

partsinfo@dpi-global.com

Website:

www.gpx.com

Free Manuals Download Website

<http://myh66.com>

<http://usermanuals.us>

<http://www.somanuals.com>

<http://www.4manuals.cc>

<http://www.manual-lib.com>

<http://www.404manual.com>

<http://www.luxmanual.com>

<http://aubethermostatmanual.com>

Golf course search by state

<http://golfingnear.com>

Email search by domain

<http://emailbydomain.com>

Auto manuals search

<http://auto.somanuals.com>

TV manuals search

<http://tv.somanuals.com>