



USER'S GUIDE
V:1023-0117-12



TDE2282B 21.5" LED HDTV + DVD

For the most up-to-date version of this User's Guide, go to www.gpx.com

Warnings and Precautions

CAUTION: TO PREVENT ELECTRIC SHOCK, MATCH WIDE BLADE OF PLUG TO WIDE SLOT, FULLY INSERT.

WARNING: To reduce the risk of fire or electric shock, do not expose this apparatus to rain or moisture.

AVERTISSEMENT: Pour réduire le risque d'incendie ou de choc électrique, ne pas exposer cet appareil sous la pluie et l'humidité.

CAUTION: Use of any controls or adjustments or performance of procedures other than those herein specified may result in hazardous radiation exposure.

WARNING: Changes or modifications to this unit not expressly approved by the party responsible for compliance could void the user's authority to operate the equipment.

WARNING: Do not place the unit on top of any soft, porous, or sensitive surfaces to avoid damaging the surface. Use a protective barrier between the unit and surface to protect the surface.

WARNING: Use of this unit near fluorescent lighting may cause interference regarding use of the remote. If the unit is displaying erratic behavior move away from any fluorescent lighting, as it may be the cause.

CAUTION: Danger of explosion if battery is incorrectly replaced. Replace only with the same or equivalent type.

PRÉCAUTION: Danger d'explosion si les piles sont remplacées de façon incorrect. Remplacer les piles seulement par le même type de pile ou l'équivalent.

WARNING: Shock hazard - Do Not Open.

AVIS: RISQUE DE CHOC ÉLECTRIQUE - NE PAS OUVRIR

Mains Plug or Direct plug-in adapter is used as disconnect device and it should remain readily operable during intended use. In order to disconnect the apparatus from the mains completely, the Mains Plug or Direct plug-in adapter should be disconnected from the mains socket outlet completely.

La fiche d'alimentation ou adaptateur de courant est utilisé comme dispositif de déconnexion et doit rester accessible pendant l'utilisation. Pour mettre l'appareil hors tension, la fiche ou adaptateur de courant doit être débranché de la prise de courant.

Do not mix old and new batteries.

Do not mix alkaline, standard (carbon-zinc), or rechargeable (ni-cad, ni-mh, etc) batteries.

No mezcle baterías viejas y nuevas.

No mezcle baterías alcalinas, estándar (carbóno-zinc) o recargables (ni-cad, ni-mh, etc.).



WARNING: TO REDUCE THE RISK OF ELECTRIC SHOCK, DO NOT REMOVE COVER (OR BACK). NO USER-SERVICEABLE PARTS INSIDE. REFER SERVICING TO QUALIFIED SERVICE PERSONNEL.



The lightning flash with arrowhead symbol, within an equilateral triangle, is intended to alert the user to the presence of uninsulated "dangerous voltage" within the product's enclosure that may be of sufficient magnitude to constitute a risk of electric shock to persons.



The exclamation point within an equilateral triangle is intended to alert the user to the presence of important operating and maintenance (servicing) instructions in the literature accompanying the appliance.

Important Safety Instructions

1. Read these Instructions.
2. Keep these Instructions.
3. Heed all Warnings.
4. Follow all instructions.
5. Do not use this apparatus near water.
6. Clean only with a dry cloth.
7. Do not block any ventilation openings. Install in accordance with the manufacturer's instructions.
8. Do not install near any heat sources such as radiators, heat registers, stoves, or other apparatus (including amplifiers) that produce heat.
9. Do not defeat the safety purpose of the polarized or grounding - type plug. A polarized plug has two blades with one wider than the other. A grounding type plug has two blades and a third grounding prong. The wide blade or the third prong are provided for your safety. When the provided plug does not fit into your outlet, consult an electrician for replacement of the obsolete outlet.
10. Protect the power cord from being walked on or pinched particularly at plugs, convenience receptacles, and the point where they exit from the apparatus.
11. Only use attachments/accessories specified by the manufacturer.

-
12.  Use only with a cart, stand, tripod, bracket, or table specified by the manufacturer, or sold with the apparatus. When a cart is used, use caution when moving the cart/apparatus combination to avoid injury from tip-over.
-

13. Unplug this apparatus during lightning storms or when unused for long periods of time.
14. Refer all servicing to qualified service personnel. Servicing is required when the apparatus has been damaged in any way, such as power-supply cord or plug is damaged, liquid has been spilled or objects have fallen into the apparatus, the apparatus has been exposed to rain or moisture, does not operate normally, or has been dropped.

Special note: When placing your unit on a lacquered or natural finish, protect your furniture with a cloth or other protective material.

FCC Warnings

WARNING: Changes or modifications to this unit not expressly approved by the party responsible for compliance could void the user's authority to operate the equipment.

NOTE: This equipment has been tested and found to comply with the limits for a Class B digital device, pursuant to Part 15 of the FCC Rules. These limits are designed to provide reasonable protection against harmful interference in a residential installation. This equipment generates, uses, and can radiate radio frequency energy and, if not installed and used in accordance with the instructions, may cause harmful interference to radio communications. However, there is no guarantee that interference will not occur in a particular installation. If this equipment does cause harmful interference to radio or television reception, which can be determined by turning the equipment off and on, the user is encouraged to try to correct the interference by one or more of the following measures:

- Reorient or relocate the receiving antenna.
- Increase the separation between the equipment and receiver.
- Connect the equipment into an outlet on a circuit different from that to which the receiver is connected.
- Consult the dealer or an experienced radio/TV technician for help.

Additional Warnings

The apparatus shall not be exposed to dripping or splashing and that no objects filled with liquids, such as vases, shall be placed on apparatus.

L'appareil ne doit pas être exposé aux écoulements ou aux éclaboussures et aucun objet ne contenant de liquide, tel qu'un vase, ne doit être placé sur l'objet.

Battery shall not be exposed to excessive heat such as sunshine, fire or the like.

Les piles ne doivent pas être exposées à de forte chaleur, tel qu'à la lumière du soleil, au feu ou autres choses de semblable.

Caution marking is located at the rear or bottom of the apparatus.

Attention marquage est situé sur le panneau arrière ou inférieur de l'unité.

The marking information is located at the rear or bottom of apparatus.

Le marquage est situé sur le panneau arrière ou inférieur de l'unité.



This symbol indicates that this product incorporates double insulation between hazardous mains voltage and user accessible parts.

TDE2282B

Features

- 21.5" LED display
- Display supports: 720p, 1080i, 1080p
- 1920 x 1080 native resolution
- DVD player: DVD, DVD±R/RW
- CD player: CD, CD-R/RW, JPEG CD
- Aspect ratio: 16:9
- Brightness: 250cd/m²
- Contrast: 1000:1
- Max color: 16.7 million
- Response time: <5ms
- Viewing angle: 160°H, 160°V
- ATSC/NTSC tuner
- V-chip
- Slot-load disc player
- Electronic program guide
- Sleep timer
- Closed captioning
- Digital volume control
- Built-in stereo speakers
- HDMI input
- Component video input
- VGA PC video input
- Composite video input
- USB port: supports JPEG, MP3 file formats
- SD/MMC/MS memory card reader: supports JPEG, MP3
- Optical digital audio output
- RCA stereo audio inputs
- 3.5mm PC audio input
- RF input
- Stereo headphone jack
- USB service port: for firmware updates only
- Full-function remote
- Wall mountable
- Dual Voltage: 220V/50Hz, 120V/60Hz
- DC power input: requires an AC/DC power adapter (included)

Includes

- Remote control: requires 2 AAA batteries (included)
- Removable stand: 4 screws
- AC/DC power adapter

Setup

Power

AC power: requires an AC/DC power adapter (included).

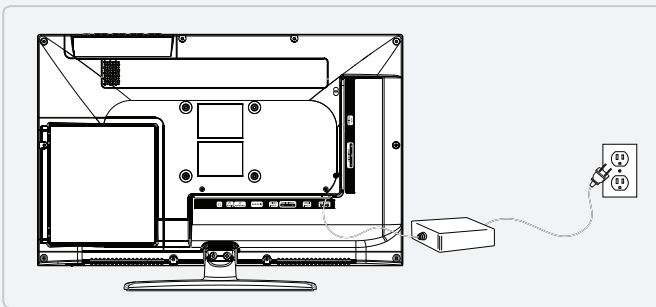

Remote

Requires 2 AAA batteries (included)

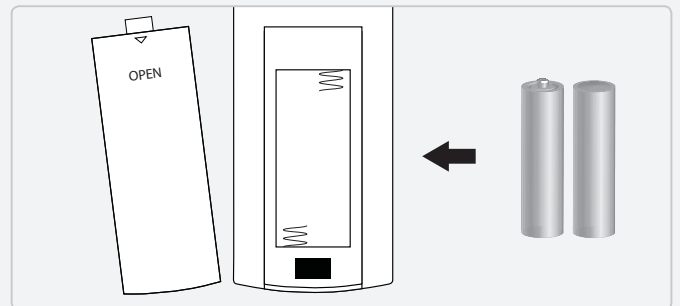

Attaching the Stand

Use a philips-head screwdriver to tighten or remove the screws. Using an power drill could damage the TV stand.

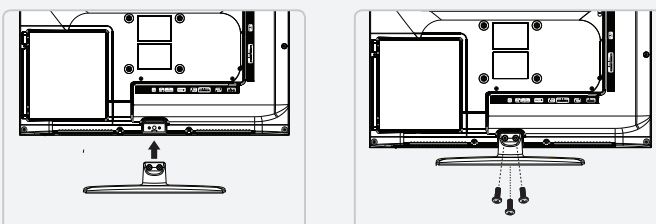
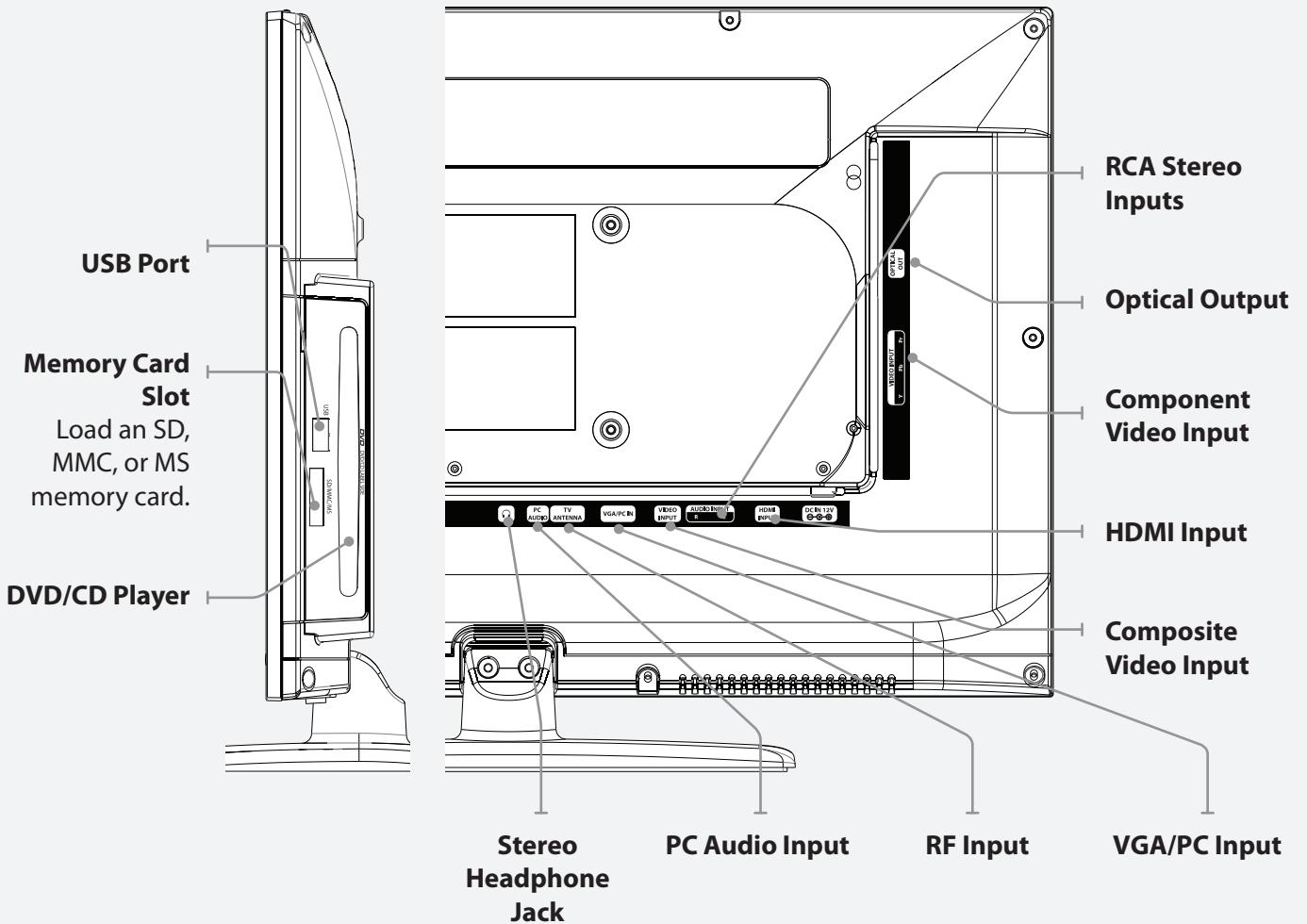
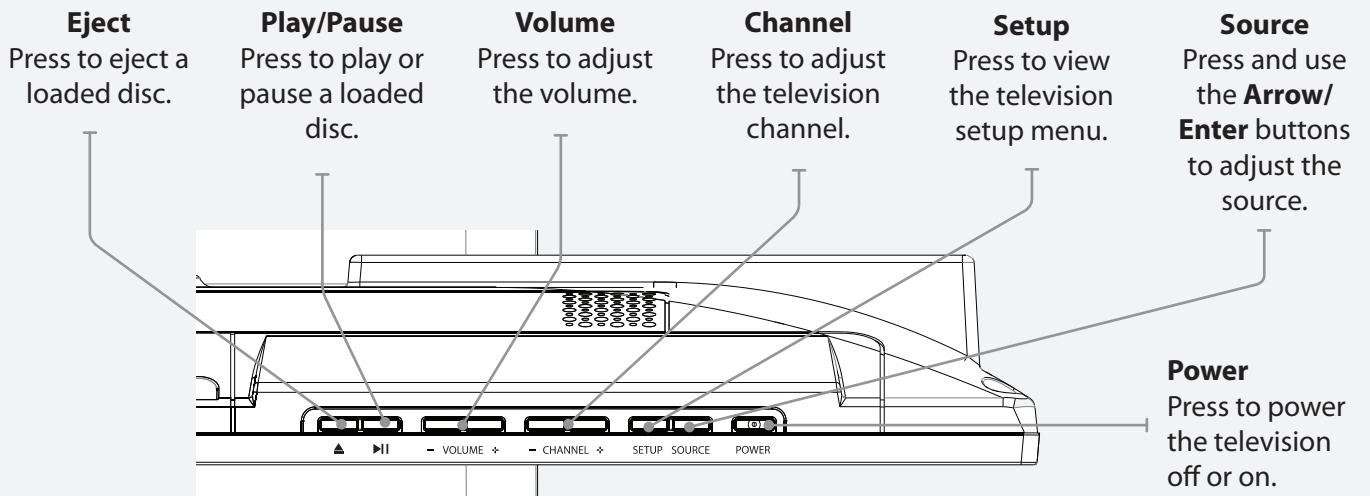
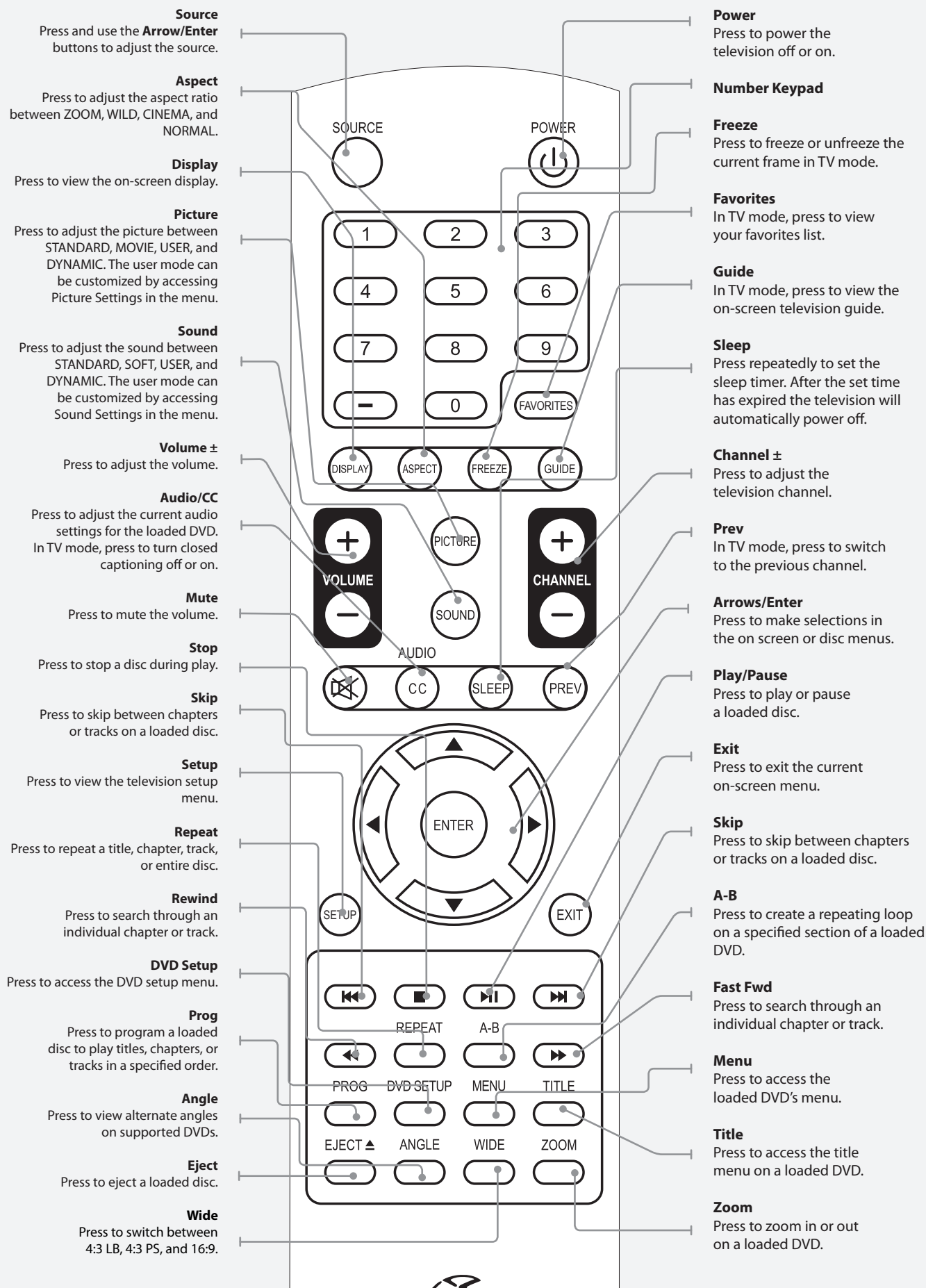

Table of Contents

Warnings and Precautions	2
Important Safety Instructions	3
TDE2282B	4
Features	
Includes	
Setup	4
Power	
Attaching the Stand	
Remote	
Table of Contents	5
Introduction	6
Setup	8
Connecting a TV Antenna	
Connecting a Set-Top box	
Auto Scanning for Channels	
Connecting Basic Cable	
Favorites and Clock	9
Adding Favorites	
Viewing Favorites	
Setting the Clock	
Parental Controls	10
Parental Controls (V-Chip)	
DVD and CD	11
Loading a DVD or CD	
Playing a DVD or CD	
Programming a DVD or CD	
Connecting Other Devices	12
Connecting a Set-Top Box	
Connecting a Gaming Device	
Connecting a DVD Player or VCR	
Connecting Other Devices	13
Connecting a Computer	
Using the Optical Audio Out	
USB and SD, MMC, MS Memory Card	14
Connecting a USB Thumb Drive	
Using a USB Thumb Drive	
Connecting an SD, MMC, or MS Memory Card	
Using an SD, MMC, or MS Memory Card	
Mounting to a Wall	15
Important Notes	
Company Information	16
International Support	
Contact Information	
Warranty	
Green Initiative	

Introduction





Setup

Connecting a TV Antenna

Requires a TV antenna (not included).

1. Connect a VHF, UHF, or HDTV antenna to the **RF Input** on the television.
2. Press the **Source** button to switch to TV mode.
3. Press the **Setup** button to access the setup menu.
4. Press the **Arrow** (◀ ▶) buttons to highlight the CHANNEL icon. Press the **Enter** button.
5. Press the **Arrow** (▼ ▲) buttons to highlight SIGNAL TYPE. Press the **Arrow** (◀ ▶) buttons to select AIR.
6. Press the **Arrow** (▼ ▲) buttons to highlight AUTO CHANNEL SEARCH. Press the **Enter** button to begin scanning for available channels.

Connecting Basic Cable

Requires a cable connection.

1. Connect a cable to the **RF Input** on the television.
2. Press the **Source** button to switch to TV mode.
3. Press the **Setup** button to access the setup menu.
4. Press the **Arrow** (◀ ▶) buttons to highlight the CHANNEL icon. Press the **Enter** button.
5. Press the **Arrow** (▼ ▲) buttons to highlight SIGNAL TYPE. Press the **Arrow** (◀ ▶) buttons to select CABLE.
6. Press the **Arrow** (▼ ▲) buttons to highlight AUTO CHANNEL SEARCH. Press the **Enter** button to begin scanning for available channels.

Connecting a Set-Top box

Requires a Set-Top Box (not included).

If your Set-Top Box has an HDMI Output:

- Connect the HDMI output on the Set-Top Box to the **HDMI Input** on the television using an HDMI cable (not included).

If your Set-Top Box has a Composite Video Output:

- Connect the video output on the Set-Top Box to the **Composite Video Input** on the television using an A/V RCA cable (not included). Connect the audio output on the Set-Top Box to the **RCA Audio Input** on the television.

If your Set-Top Box has a Component Video Output:

- Connect the component video output on the Set-Top Box to the **Component Video Input** on the television using a component RCA cable (not included). Connect the audio output on the Set-Top Box to the **RCA Audio Input** on the television.

After connecting your Set-Top Box:

- Press the **Source** button to switch to YPBPR, AV, or HDMI to match the connection used.

Auto Scanning for Channels

The Auto Channel Scan must be run before any channels can be viewed on the television.

1. Press the **Source** button to switch to TV mode.
2. Press the **Setup** button to access the setup menu.
3. Press the **Arrow** (◀ ▶) buttons to highlight the CHANNEL icon. Press the **Enter** button.
4. Press the **Arrow** (▼ ▲) buttons to highlight SIGNAL TYPE. Press the **Arrow** (◀ ▶) buttons to select AIR.
5. Press the **Arrow** (▼ ▲) buttons to highlight AUTO CHANNEL SEARCH. Press the **Enter** button to begin scanning for available channels.

Favorites and Clock

Adding Favorites

1. Press the **Source** button to switch to TV mode.
2. Press the **Setup** button to access the setup menu.
3. Press the **Arrow** (◀ ▶) buttons to highlight the CHANNEL icon. Press the **Enter** button.
4. Press the **Arrow** (▼ ▲) buttons to highlight the CHANNEL SETTING icon. Press the **Enter** button.
5. Use the **Arrow** (◀ ▶) and **Enter** buttons to select the channel as a favorite.

Viewing Favorites

1. Press the **Source** button to switch to TV mode.
2. Press the **Favorites** button to view a list of your saved favorites.

Setting the Clock

1. Press the **Setup** button to access the setup menu.
2. Press the **Arrow** (◀ ▶) buttons to highlight the SETUP icon. Press the **Enter** button.
3. Press the **Arrow** (▼ ▲) buttons to highlight CLOCK. Press the **Enter** button.
4. Press the **Arrow** (▼ ▲) buttons to highlight TIME ZONE. Press the **Arrow** (◀ ▶) buttons to select your current time zone.
5. Press the **Arrow** (▼ ▲) buttons to highlight AUTO CLOCK. Press the **Arrow** (◀ ▶) buttons to turn auto clock off and on.

When the correct time zone is set, auto clock will automatically set your clock and date for you.

6. To set the time and date manually, turn auto clock off, highlight SETUP TIME, and use the **Arrow** and **Enter** buttons to manually set the time and date.

Parental Controls

Parental Controls (V-Chip)

1. Press the **Source** button to switch to TV mode.
2. Press the **Setup** button.
3. Press the **Arrow** (◀ ▶) buttons, highlight the PARENTAL CONTROL picture, and press the **Enter** button.
4. The default passcode for the parental lock is:
0 0 0 0
5. Enter the passcode to access the PARENTAL CONTROL preferences.
6. From this menu, you can lock specific ratings from the United States rating system or the Canadian rating system by accessing the V-CHIP settings. You can also lock the buttons on the television or lock specific sources from access.

DVD and CD

Loading a DVD or CD

1. Insert a DVD or CD into the slot-load disc drive, with the label side of the DVD or CD facing the back of the television.

Once a DVD or CD is loaded into the television, the TV will automatically switch to DVD mode.

Playing a DVD or CD

1. Follow the instructions for Loading a DVD or CD.
2. After the DVD or CD is loaded, it will begin playing automatically.

*If the DVD or CD does not begin playing automatically, press the **Play/Pause** button to begin playing the loaded disc.*

Programming a DVD or CD

1. While a DVD or CD is playing, press the **Program** button on the remote.
2. Using the **Number Keypad** enter in the title (TT) and chapters (CH), or tracks in the order you want them to play.
3. Highlight the on-screen START button using the **Arrow** buttons and press the **Enter** button.
4. The programmed titles and chapters, or tracks will now play in the designated order.
5. To cancel a program, press the **Stop** button twice.

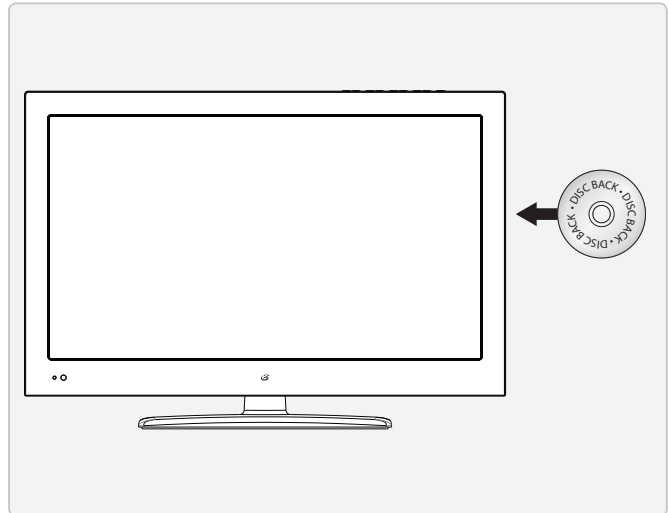

Connecting Other Devices

Connecting a Set-Top Box

You will need: a set-top box, composite and RCA stereo cables or component and RCA stereo cables or an HDMI cable (not included).

1. Connect the set-top box's *audio* and *video outputs* to the corresponding audio and video inputs on the television.
2. Power the television on and press the **Source** button to switch to the connected input (AV (composite), YPbPr (component), or HDMI).

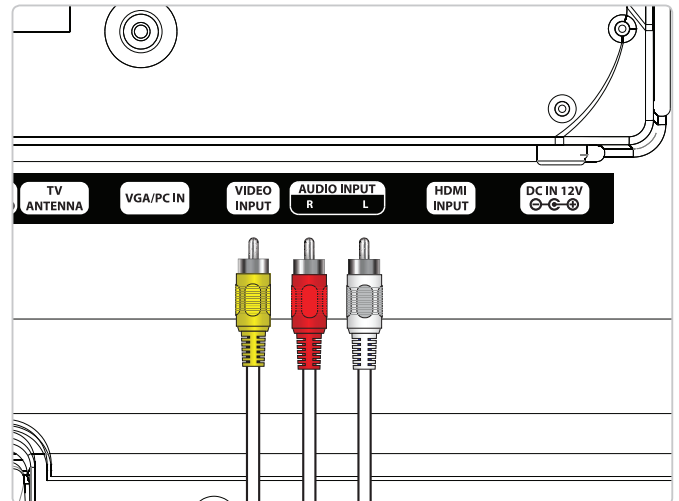

Connecting a Gaming Device

You will need: a gaming device, composite and RCA stereo cables or component and RCA stereo cables or an HDMI cable (not included).

1. Connect the gaming device's *audio* and *video outputs* to the corresponding audio and video inputs on the television.
2. Power the television on and press the **Source** button to switch to the connected input (AV (composite), YPbPr (component), or HDMI).

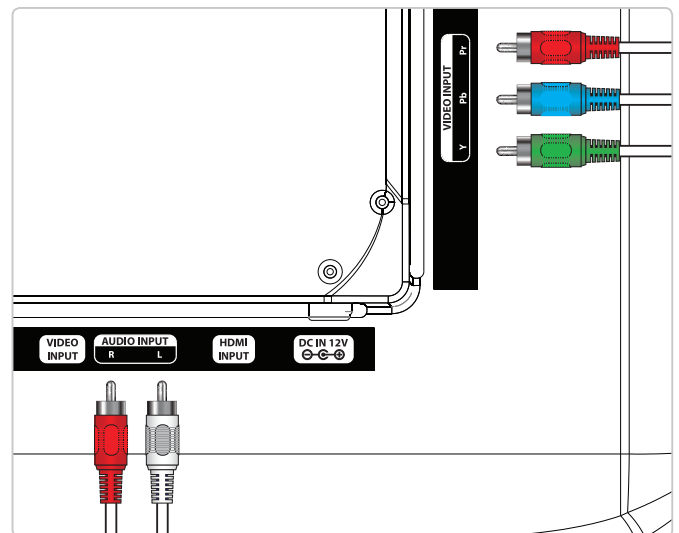

Connecting a DVD Player or VCR

You will need: a DVD player or VCR, composite and RCA stereo cables or component and RCA stereo cables or an HDMI cable (not included).

1. Connect the DVD player or VCR's *audio* and *video outputs* to the corresponding audio and video inputs on the television.
2. Power the television on and press the **Source** button to switch to the connected input (AV (composite), YPbPr (component), or HDMI).

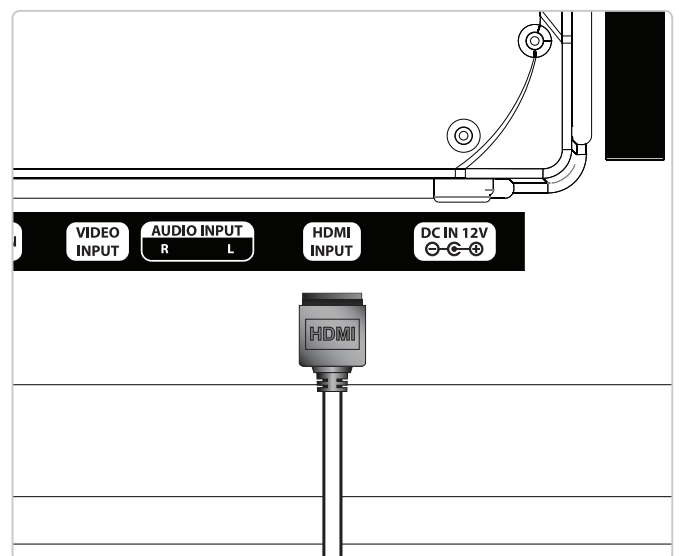

Connecting Other Devices

Connecting a Computer

You will need: a PC with a VGA output, and a VGA cable (not included).

1. Connect the computer's *VGA output* to the **VGA/PC Input** on the television.
2. Power the television on and press the **Source** button to switch to the *PC Mode*.
3. Audio from the connected PC can be input to the television through the TV's **PC Audio Input** by using a 3.5mm audio cable (not included).

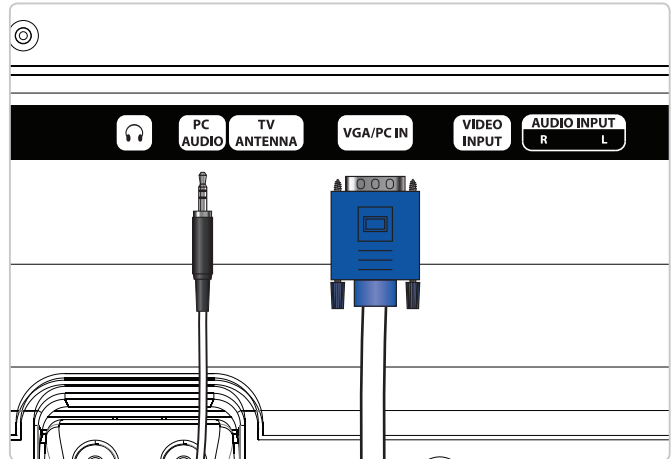

Using the Optical Audio Out

You will need: a (home theater) with an **Optical Audio Input** and a Digital Optical Audio Cable (not included).

1. Connect the Digital Optical Audio Cable to the (home theater system) and the television.
2. Adjust the settings on your (home theater) to play audio from the connected **Optical Audio Input**.

Please note: home theater systems may label the Optical Audio Input source differently, such as "PCM", or "Digital Audio Input". Please consult your home theater system's user manual in order to select the correct input source.

3. Audio from the television will now be played through the connected (home theater system).

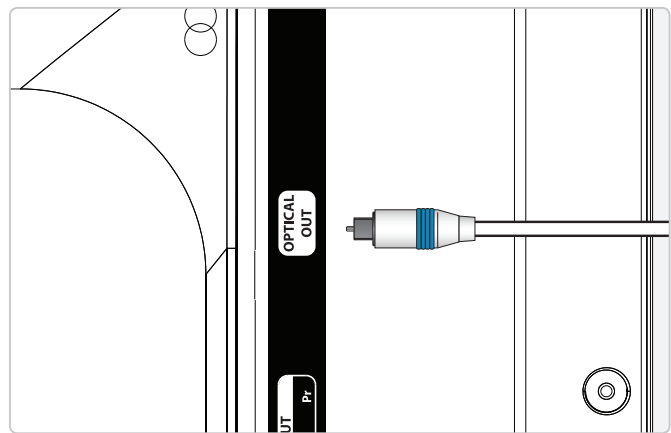

USB and SD, MMC, MS Memory Card

Connecting a USB Thumb Drive

1. Load a USB thumb drive into the **USB Port** as shown in the image to the right.

Using a USB Thumb Drive

1. Follow the instructions for [Connecting a USB thumb drive](#).
2. Press the **Source** button to switch to USB mode.
3. Use the **Arrow** and **Enter** buttons to select and play content from the connected USB thumb drive.

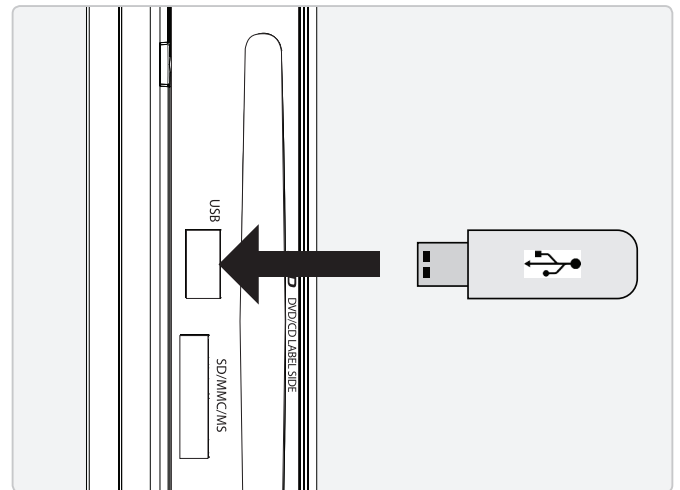

Connecting an SD, MMC, or MS Memory Card

1. Load an SD, MMC, or MS memory card into the **Card Slot** as shown in the image to the right.

Using an SD, MMC, or MS Memory Card

1. Follow the instructions for [Connecting an SD, MMC, or MS Memory Card](#).
2. Press the **Source** button on the remote to switch to Card mode.
3. Use the **Arrow** and **Enter** buttons to select and play content from the connected SD, MMC, or MS memory card.

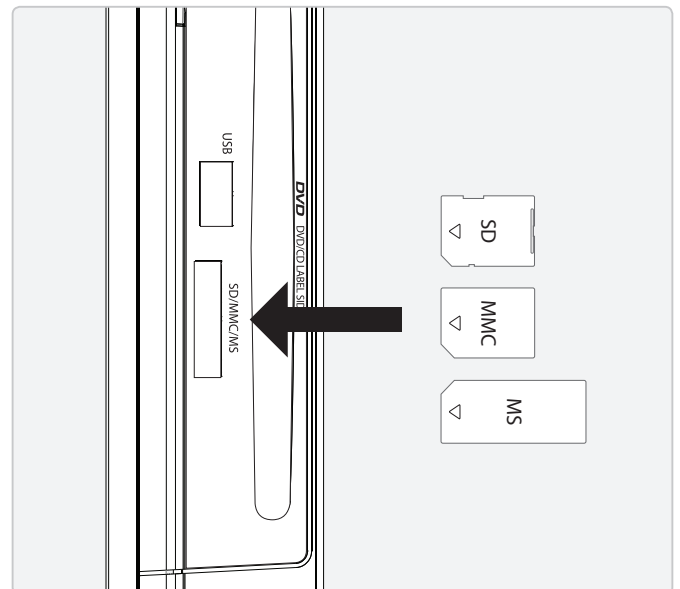

Mounting to a Wall

Important Notes

We recommend having this television professionally mounted.

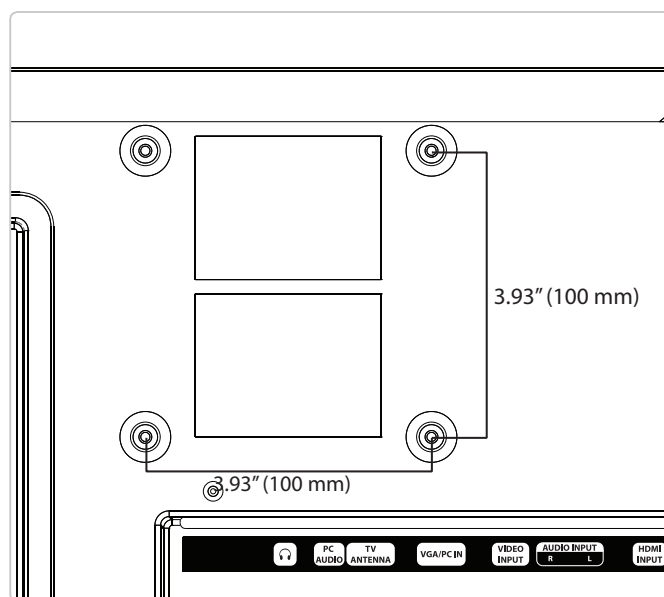

Company Information

International Support

To download this User's Guide in English, Spanish, and French, or to get answers to frequently asked questions, visit the support section at www.gpx.com.

Para descargar este Manual del Usuario en inglés, español y francés, o para obtener respuestas a preguntas frecuentes, visite la sección de apoyo en www.gpx.com.

Pour télécharger ce guide de l'utilisateur en anglais, espagnol ou français, ou pour obtenir des réponses à des questions fréquemment posées, consultez la rubrique d'assistance sur www.gpx.com.

Contact Information

Phone: 1-888-999-4215

Email: prodinfo@gpx.com

Parts Email: partsinfo@dpi-global.com

Website: www.gpx.com

Warranty

For Warranty Information and the most up-to-date version of this User's Guide, go to: www.gpx.com

Green Initiative



Environmental Commitment to 'Protect for Today and Sustain for Tomorrow'

On a continual basis DPI, Inc. is making efforts to sustain the environment and improve the recyclability of its products and packaging.

Focusing on "protecting for today and sustaining for tomorrow" DPI, Inc. has committed to reducing packaging size, increasing the usage of recyclable plastics, and ensuring that packaging and manuals are made with up to 85% recycled material. In addition to material consideration, DPI, Inc. has also focused on the finer details that positively impact the environment such as employing the usage of soy-based inks.

DPI, Inc. also ensures that the factories that produce the company's wide variety of consumer electronics adhere to environmentally friendly air and water restrictions. This is yet another example that every step of the way DPI, Inc. is making efforts to lessen any impact on the environment.

In 2011 DPI, Inc. also began conversations with Energy Star in order to ensure that the consumer electronics being produced meet high standards of energy efficiency. The ultimate goal is keeping energy costs for consumers low while providing quality, feature-rich products.

Free Manuals Download Website

<http://myh66.com>

<http://usermanuals.us>

<http://www.somanuals.com>

<http://www.4manuals.cc>

<http://www.manual-lib.com>

<http://www.404manual.com>

<http://www.luxmanual.com>

<http://aubethermostatmanual.com>

Golf course search by state

<http://golfingnear.com>

Email search by domain

<http://emailbydomain.com>

Auto manuals search

<http://auto.somanuals.com>

TV manuals search

<http://tv.somanuals.com>