



USER'S GUIDE

V:1246-1019-09



IHH810B





2.1 Channel Home Theater System with Dock for iPod

WARNINGS AND PRECAUTIONS

- **CAUTION:** TO PREVENT ELECTRIC SHOCK, MATCH WIDE BLADE OF PLUG TO WIDE SLOT, FULLY INSERT.
- **WARNING:** To prevent fire or shock hazards, do not expose this unit to rain or moisture.
- **CAUTION:** Use of controls or adjustments or performance of procedures other than those specified may result in hazardous radiation exposure.
- **WARNING:** Changes or modifications to this unit not expressly approved by the party responsible for compliance could void the user's authority to operate the equipment.
- **WARNING:** Do not place the unit on top of any soft, porous, or sensitive surfaces to avoid damaging the surface. Use a protective barrier between the unit and surface to protect the surface.
- **WARNING:** Use of this unit near fluorescent lighting may cause interference regarding use of the remote. If the unit is displaying erratic behavior move away from any fluorescent lighting, as it may be the cause.
- **CAUTION:** Danger of explosion if battery is incorrectly replaced. Replace only with the same or equivalent type.
- **PRÉCAUTION:** *Danger d'explosion si les piles sont remplacées de façon incorrect. Remplacer les piles seulement par le même type de pile ou l'équivalent.*
- **WARNING:** There is a danger of explosion if you attempt to charge standard Alkaline batteries in the unit. Only use rechargeable NiMH batteries.
- **WARNING:** The remote control's button cell battery contains mercury. Do not put in the trash, instead recycle or dispose of as hazardous waste.
- **WARNING:** Lithium batteries, like all rechargeable batteries are recyclable and should be recycled or disposed of in normal household waste. Contact your local government for disposal or recycling practices in your area. They should never be incinerated since they might explode.

Main plug is used as disconnect device and it should remain readily operable during intended use.

Do not mix old and new batteries.
Do not mix alkaline, standard (carbon-zinc), or rechargeable (ni-cad, ni-mh, etc) batteries.
No mezcle baterias viejas y nuevas.
No mezcle baterias alcalinas, estándar (carbone-zinc) o recargables (ni-cad, ni-mh, etc.).

| | |
|---|---|
|  | <p>WARNING: TO REDUCE THE RISK OF ELECTRIC SHOCK, DO NOT REMOVE COVER (OR BACK). NO USER-SERVICEABLE PARTS INSIDE. REFER SERVICING TO QUALIFIED SERVICE PERSONNEL.</p> |
|  | <p>The lightning flash with arrowhead symbol, within an equilateral triangle, is intended to alert the user to the presence of uninsulated "dangerous voltage" within the product's enclosure that may be of sufficient magnitude to constitute a risk of electric shock to persons.</p> |
|  | <p>The exclamation point within an equilateral triangle is intended to alert the user to the presence of important operating and maintenance (servicing) instructions in the literature accompanying the appliance.</p> |
|  | <p>This product utilizes a Class 1 laser to read Compact Discs. This Laser Compact Disc Player is equipped with safety switches to avoid exposure when the CD door is open and the safety interlocks are defeated. Invisible laser radiation is present when the CD Player's lid is open and the system's interlock has failed or been defeated. It is very important that you avoid direct exposure to the laser beam at all times. Please do not attempt to defeat or bypass the safety switches.</p> |

IMPORTANT SAFETY INSTRUCTIONS

1. Read these Instructions.
2. Keep these Instructions.
3. Heed all Warnings.
4. Follow all instructions.
5. Do not use this apparatus near water.
6. Clean only with a dry cloth.
7. Do not block any ventilation openings. Install in accordance with the manufacturer's instructions.
8. Do not install near any heat sources such as radiators, heat registers, stoves, or other apparatus (including amplifiers) that produce heat.
9. Do not defeat the safety purpose of the polarized or grounding - type plug. A polarized plug has two blades with one wider than the other. A grounding type plug has two blades and a third grounding prong. The wide blade or the third prong are provided for your safety. When the provided plug does not fit into your outlet, consult an electrician for replacement of the obsolete outlet.
10. Protect the power cord from being walked on or pinched particularly at plugs, convenience receptacles, and the point where they exit from the apparatus.
11. Only use attachments/accessories specified by the manufacturer.

12. Use only with a cart, stand, tripod, bracket, or table specified by the manufacturer, or sold with the apparatus. When a cart is used, use caution when moving the cart/apparatus combination to avoid injury from tip-over.



13. Unplug this apparatus during lightning storms or when unused for long periods of time.
14. Refer all servicing to qualified service personnel. Servicing is required when the apparatus has been damaged in any way, such as power-supply cord or plug is damaged, liquid has been spilled or objects have fallen into the apparatus, the apparatus has been exposed to rain or moisture, does not operate normally, or has been dropped.

FCC Warnings

NOTE: This equipment has been tested and found to comply with the limits for a Class B digital device, pursuant to Part 15 of the FCC Rules. These limits are designed to provide reasonable protection against harmful interference in a residential installation. This equipment generates, uses, and can radiate radio frequency energy and, if not installed and used in accordance with the instructions, may cause harmful interference to radio communications. However, there is no guarantee that interference will not occur in a particular installation. If this equipment does cause harmful interference to radio or television reception, which can be determined by turning the equipment off and on, the user is encouraged to try to correct the interference by one or more of the following measures:

- Reorient or relocate the receiving antenna.
- Increase the separation between the equipment and receiver.
- Connect the equipment into an outlet on a circuit different from that to which the receiver is connected.
- Consult the dealer or an experienced radio/TV technician for help.

Additional Warnings

- The apparatus shall not be exposed to dripping or splashing and that no objects filled with liquids, such as vases, shall be placed on apparatus.
L'appareil ne doit pas être exposé aux écoulements ou aux éclaboussures et aucun objet ne contenant de liquide, tel qu'un vase, ne doit être placé sur l'objet.
- Main plug is used as disconnect device and it should remain readily operable during intended use. In order to disconnect the apparatus from the mains completely, the mains plug should be disconnected from the mains socket outlet completely.
La prise du secteur ne doit pas être obstruée ou doit être facilement accessible pendant son utilisation. Pour être complètement déconnecté de l'alimentation d'entrée, la prise doit être débranchée du secteur.
- Battery shall not be exposed to excessive heat such as sunshine, fire or the like.
Les piles ne doivent pas être exposées à de forte chaleur, tel qu'à la lumière du soleil, au feu ou autres choses de semblable.
- Caution marking is located at the rear of apparatus.
Les précautions d'emploi sont inscrites en bas de l'appareil.
- The marking information is located at the rear of apparatus.
Les marquages sont inscrits en bas de l'appareil.

2.1 CHANNEL HOME THEATER SYSTEM WITH DOCK FOR IPOD

Features

- Docking Station for iPod®
- Certified iPod Connector installed for iPod docking.
- Recharge Circuit for iPod/mini/nano/photo/video
- Controls connected iPod players
- iPod Authentication IC installed
- 2.1 Channel Speaker System
- Resonant Wood Stereo & Subwoofer Speakers with Cloth Grills
- Drawer-Load DVD Player
- Plays DVD, DVD-R/RW, DVD+R/RW, CD, CD-R/RW & JPEG Picture Discs
- High Definition Conversion DVD up to 1080p controlled by OSD
- Multi-Language OSD: On-Screen Display in English, French and Spanish
- TV Display Aspect Ratio: 4:3/16:9
- Digital Volume Control
- Preset EQ
- Digital Tune AM/FM Stereo Radio
- Station Memory Presets: 20-FM & 20-AM
- Backlit LCD Display with Digital Clock
- Video Out Jack for iPod photo & video versions, RCA type
- Line-In jack for other Audio Players, 3.5mm
- Aux-In Audio Input Jacks, L & R RCA-type
- Subwoofer Output Jack, RCA-type
- Stereo Headphone Jack
- Progressive Scan Output
- Composite Output Jack
- S-Video Output Jack
- USB Jack for Thumb Drives
- HDMI Output Jack
- Coaxial Digital Output
- SD/MMC Card Reader
- Full-Featured Remote Control
- Controls Docked iPod and player
- Direct Access - Radio Stations
- Uses 2-”AAA” Batteries
- Built-In AC Cord

Included

- IHH810B
- AM Loop Antenna
- FM Wire Antenna
- Remote Control
- Remote Batteries
- Docking Brackets for iPod
- A/V Cable

TABLE OF CONTENTS

| | |
|----------------------------|-----------|
| INTRODUCTION | 6 |
| SETUP | 10 |
| TELEVISION SETUP | 12 |
| IPOD | 14 |
| DVD/CD | 16 |
| SETUP MENU | 17 |
| RADIO | 18 |
| COMPANY INFORMATION | 20 |

INTRODUCTION

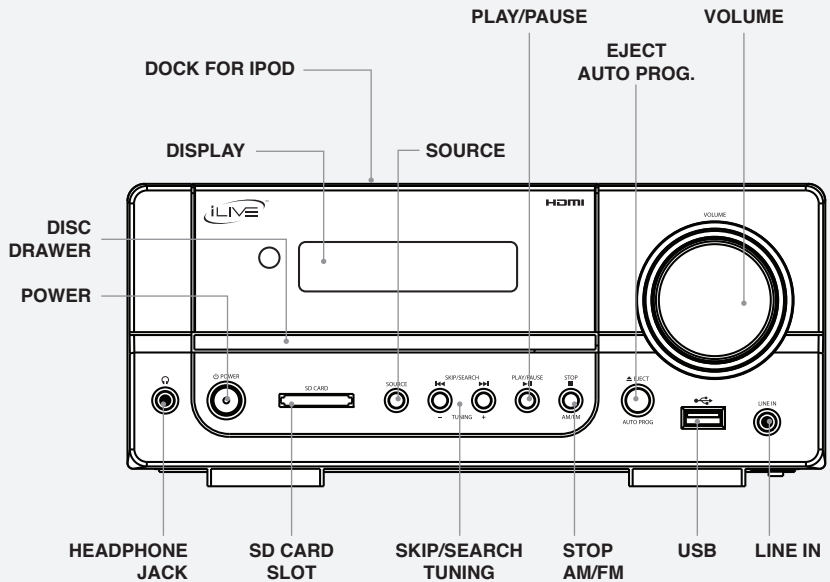

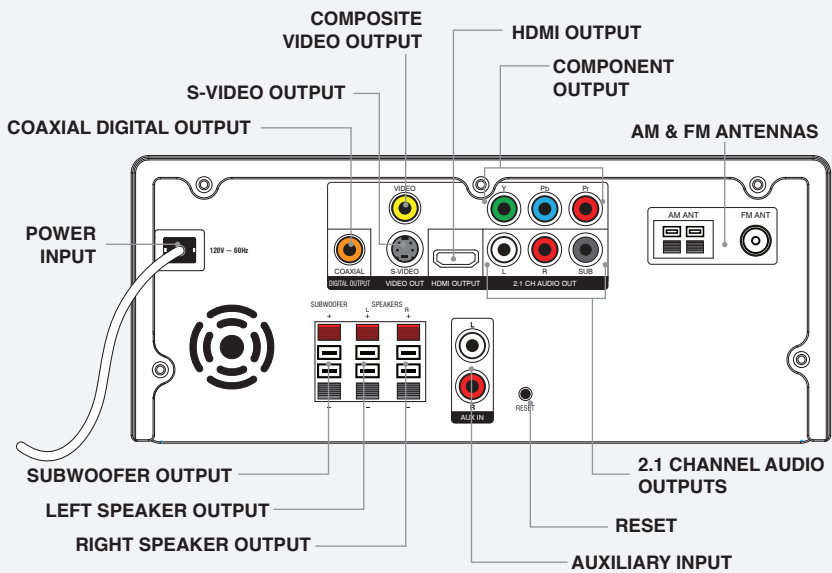

INTRODUCTION

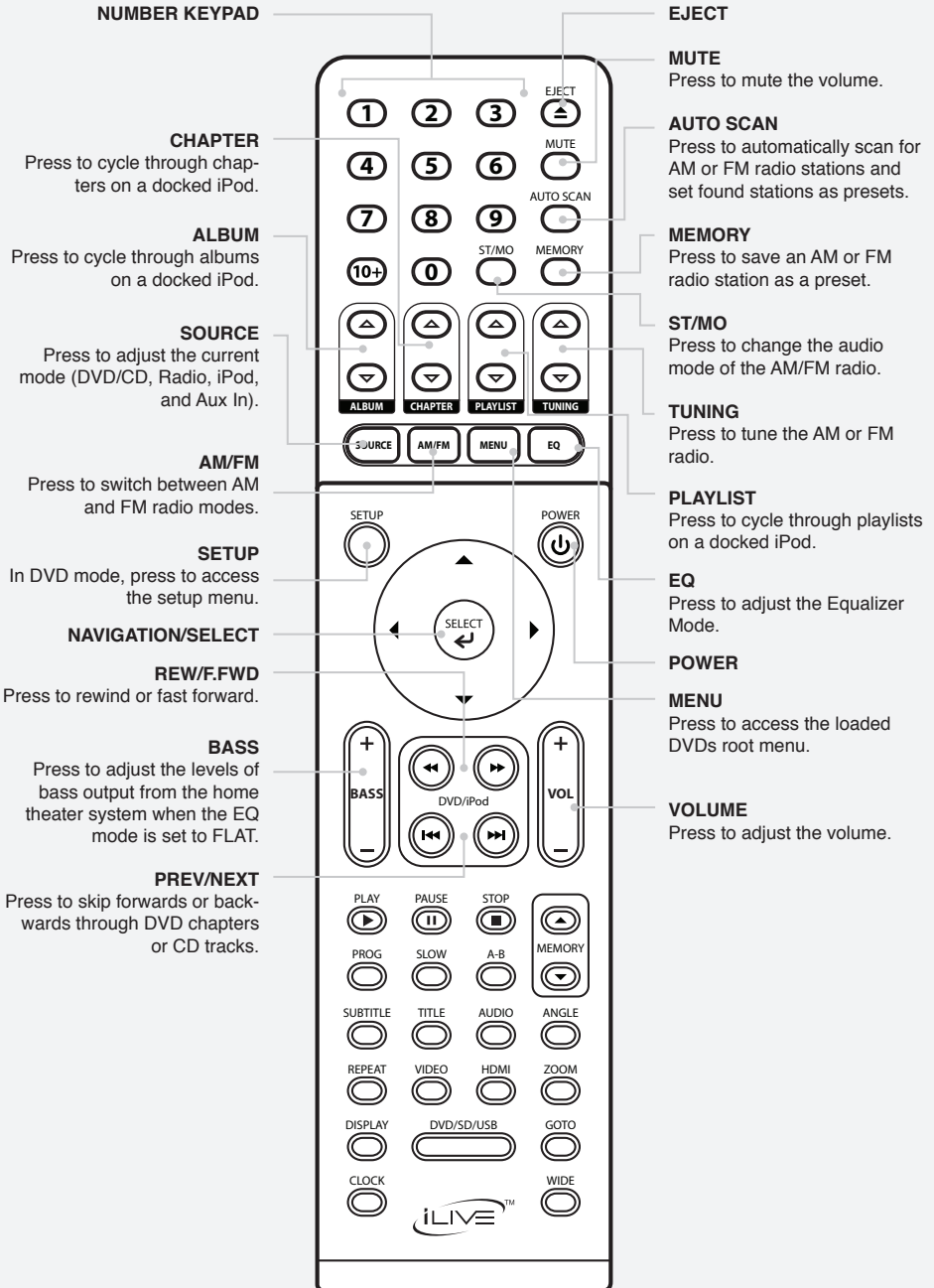

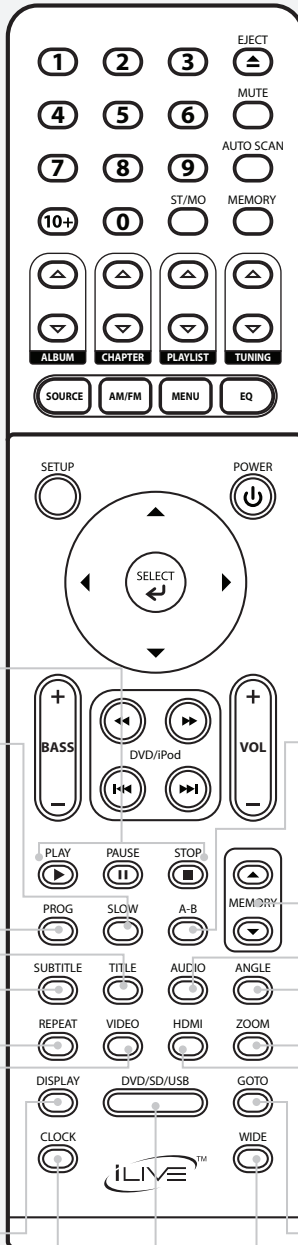

PLAY / PAUSE / STOP

SLOW

Press to view the current DVD in slow motion.

PROG

Press to program a loaded CD or DVD.

TITLE

Press to access the title menu on a loaded DVD.

SUBTITLE

Press to adjust the subtitle language for the loaded DVD.

REPEAT

Press to cycle through repeat modes for a loaded DVD or CD.

VIDEO

Press to adjust the component (YUV) video mode to off or on.

DISPLAY

Press to view on-screen information about the current DVD.

CLOCK

With the power off, press to set the clock.

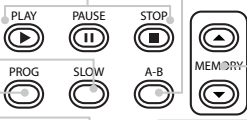
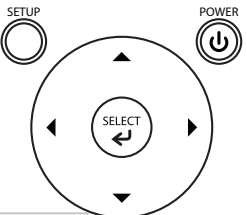

DVD/SD/USB

Press, in DVD mode to cycle through DVD, SD Card, and USB modes.

A-B

Press to repeat a designated section of the loaded DVD.

MEMORY (▲▼)

Press to cycle through preset AM and FM radio stations.

AUDIO

Press to adjust the audio language of a loaded and playing DVD.

ANGLE

Press to activate the angle feature on a loaded DVD.

ZOOM

Press to zoom in or out on a loaded DVD.

HDMI

Press to switch between 480i, 480p, 720p, 1080i, and 1080p resolutions.

GOTO

Press to enter in a specific title, chapter, or time to go to on a loaded DVD.

WIDE

Press to cycle through the different display modes.

SETUP

Power

Plug the attached AC cord into a standard AC power outlet to power the home theater system.

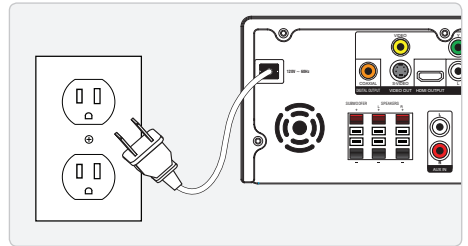

Subwoofer and Speakers

Plug the speaker and subwoofer cables into the corresponding colored **SUBWOOFER/SPEAKER CONNECTIONS**.

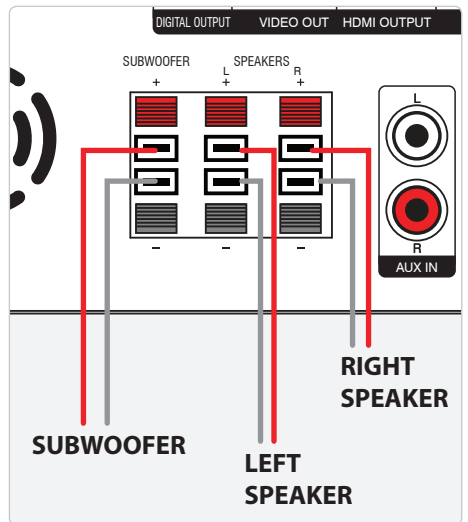

AM/FM Antennas

Connect the two ends of the AM Loop Antenna wire to the AM Antenna Connection.

Plug the FM Wire Antenna into the FM Antenna Connection.

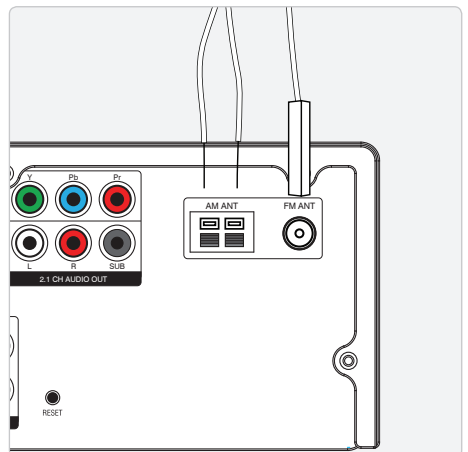

Remote

Requires 2 AAA batteries (included)

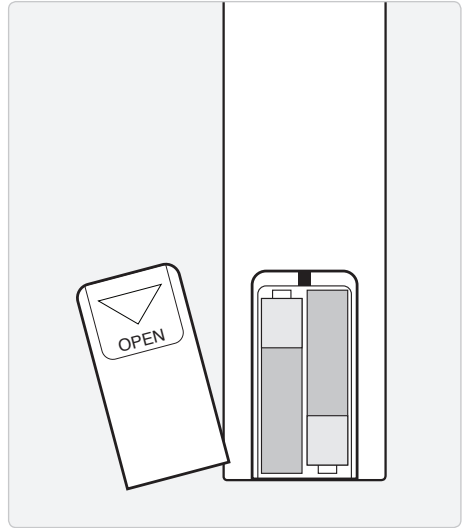

Setting the Clock

- 1 Press the **POWER** button to turn the home theater system off.
- 2 Press the **CLOCK** button, on the remote, once for AM and twice for PM.
- 3 Use the **NUMBER KEYPAD** to enter in the current time. You must type in all 4 digits of the time. For example, if it is 8:00, you would press 0, 8, 0, 0.
- 4 Press the **SELECT** button to set the adjusted time.

TELEVISION SETUP

Composite Video Setup (Good)

- 1 Connect a composite RCA cable to the composite RCA input on a television.
- 2 Connect the other end of the composite RCA cable to the **COMPOSITE VIDEO OUTPUT** on the home theater system.
- 3 Adjust your television to the input setting that matches the connection made in step 1.

S-Video Setup (Good)

- 1 Connect a s-video cable to the s-video input on a television.
- 2 Connect the other end of the s-video cable to the **S-VIDEO OUTPUT** on the home theater system.
- 3 Adjust your television to the input setting that matches the connection made in step 1.
- 4 Press the **VIDEO** button, on the remote, to turn YUV off.

Component Video Setup (Better)

- 1 Connect a component video cable to the component inputs on a television.
- 2 Connect the other end of the component video cable to the **COMPONENT VIDEO OUTPUTS** on the home theater system.
- 3 Adjust your television to the input setting that matches the connection made in step 1.

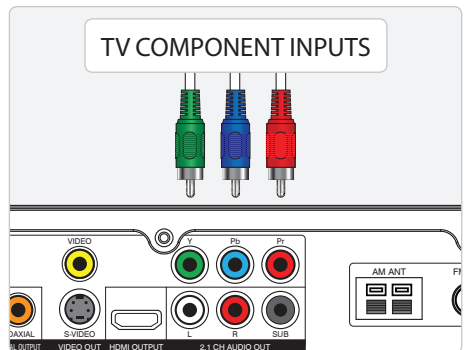

HDMI Video/Audio Setup (Best)

- 1 Connect a component video cable to the HDMI input on a television.
- 2 Connect the other end of the component video cable to the **HDMI VIDEO OUTPUT** on the home theater system.
- 3 Adjust your television to the input setting that matches the connection made in step 1.

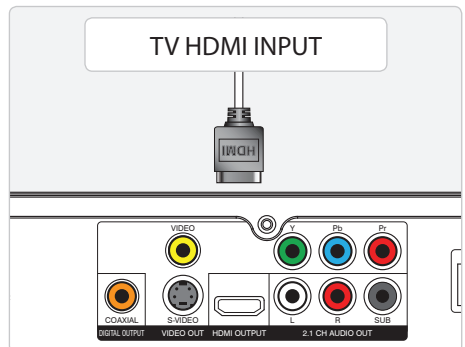

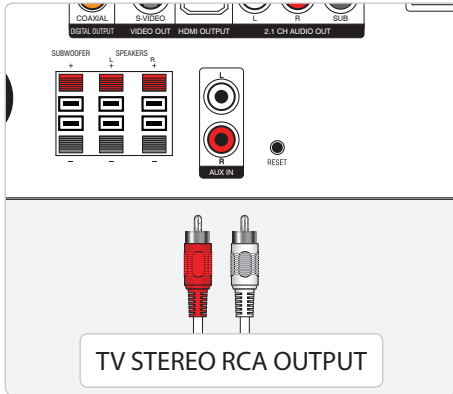

Auxiliary Audio Setup (Good)

- 1 Connect a stereo RCA cable to the stereo RCA outputs on a television.
- 2 Connect the other end of the stereo RCA cable to the **AUXILIARY INPUTS** on the home theater system.

IPOD

Docking an iPod

- 1 Locate the numbered bracket that fits the iPod that will be docked.
Each included Bracket has a number on it, indicating which iPod model that bracket is compatible with. See the separate bracket chart page to identify which bracket is needed.
- 2 Snap the bracket into place over the iPod connector in the Dock for iPod.
All Brackets will only fit one way onto the Dock.
- 3 Connect the iPod to the iPod connector inside the Dock for iPod.
- 4 Once an iPod is connected to the Dock for iPod, the unit will charge the docked iPod.

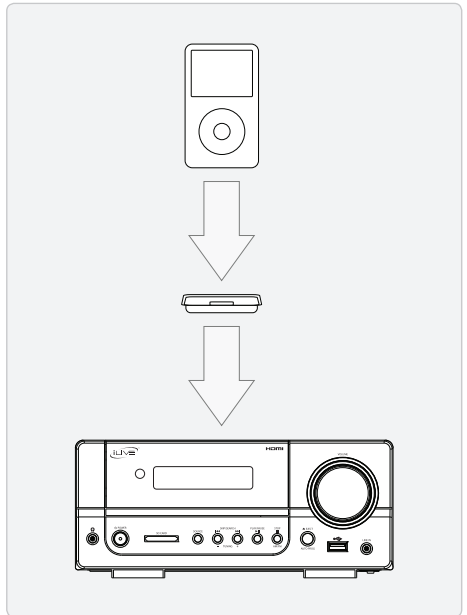

Playing an iPod

- 1 After your iPod is docked, press the **POWER** button to turn the home theater system on.
- 2 Press the **SOURCE** button to switch to iPod mode.
- 3 Press the **PLAY** button to begin playing the docked iPod.

Video Output from an iPod

- 1 Connect the home theater system to a television using the *Composite* or *S-Video Setup* listed on page 12.

Please note, video from a docked iPod cannot be output to a television using the component or HDMI video setup.

- 2 On your iPod, navigate to **VIDEOS > VIDEO SETTINGS** and turn **TV OUT** to "ON".
- 3 Follow the instructions for Docking an iPod on page 14.
- 4 Dock the iPod onto the home theater system, and begin playing a video from the docked iPod.

DVD & CD

Playing a DVD or CD

- 1 Press the **POWER** button to turn the home theater system on.
- 2 Press the **SOURCE** button to select DVD mode.
- 3 Press the **EJECT** button to open the **DISC DRAWER**.
- 4 Load a DVD or CD into the drawer, label side facing up, and press the **EJECT** button to close the **DISC DRAWER**.
- 5 The loaded DVD or CD will start playing automatically.

Programming a DVD or CD

- 1 Begin playing a loaded DVD or CD.
- 2 Press the **PROG** button on the remote.
- 3 Enter in titles and chapters (DVD) or tracks (CD) using the number keypad.
Enter these in the order you wish to watch or listen to them in.
- 4 Highlight the on-screen "Start" button and press **SELECT** to play the programmed titles and chapters or tracks.

To cancel program mode, press the **STOP** button twice.

Entering the Setup Menu

To enter the setup menu, you must be in DVD mode.

- 1 Press the **SOURCE** button to switch to DVD mode.
- 2 Press the **SETUP** button to enter the setup menu.

General

- TV Display
- Angle Mark
- OSD Language
- Screen Saver

Audio

- Downmix
- SPDIF Output

Dolby

- Dual Mono
- Dynamic

Video

- Component
- Resolution
- HDMI Setup

Preference Page

To access the preference page, the home theater system must be in full stop mode or the disc drawer must be empty. Press the **STOP** button twice to enter full stop mode.

- TV Type

HDMI Setup needs to be set to Off mode in order to adjust the TV Type. HDMI Setup can be found in the video section of the setup menu.

- Audio
- Subtitle
- Disc Menu
- Default

RADIO

Playing the AM/FM Radio

- 1 Press the **POWER** button to turn the home theater system on.
- 2 Press the **SOURCE** button to select radio mode.
- 3 Press the **AM/FM** button to switch between AM and FM radio mode.
- 4 Press the **TUNING** buttons to adjust the AM or FM radio station.

Saving an AM/FM Radio Station

- 1 Follow the steps for *Playing the AM/FM Radio*.
- 2 When tuned to the desired station, press the **MEMORY** button on the remote.
- 3 Press the **MEMORY (▲ ▼)** buttons on the remote to select a preset (ie. P01).
- 4 When the desired preset is chosen, press the **MEMORY** button to save the current station to the selected preset.
- 5 Press the **MEMORY (▲ ▼)** buttons to cycle through preset AM or FM radio stations.

Auto Scan

In radio mode, you can press the **AUTO SCAN** button, on the remote, to auto scan and save radio presets.

COMPANY INFORMATION

International Support

To download this User's Guide in English, Spanish, or French, visit the support section at www.ilive.net.

Para transferir esta guía de usuario en inglés, español, o francés, visite la sección de la ayuda en www.ilive.net.

Pour télécharger ce guide de l'utilisateur en anglais, espagnol, ou français, visitez la section de soutien chez www.ilive.net.

Contact Information

Address: 2116 Carr Street, St. Louis MO, 63106

Phone: 1-314-621-2881

Fax: 1-314-588-1805

Email: customerservice@ilive.net

Parts Email: partsinfo@dpi-global.com

Website: www.ilive.net

Free Manuals Download Website

<http://myh66.com>

<http://usermanuals.us>

<http://www.somanuals.com>

<http://www.4manuals.cc>

<http://www.manual-lib.com>

<http://www.404manual.com>

<http://www.luxmanual.com>

<http://aubethermostatmanual.com>

Golf course search by state

<http://golfingnear.com>

Email search by domain

<http://emailbydomain.com>

Auto manuals search

<http://auto.somanuals.com>

TV manuals search

<http://tv.somanuals.com>