



BD717
Portable DVD Stereo System

For the most up-to-date version of this User's Guide, go to www.gpx.com

WARNINGS AND PRECAUTIONS

- **CAUTION:** TO PREVENT ELECTRIC SHOCK, MATCH WIDE BLADE OF PLUG TO WIDE SLOT, FULLY INSERT.
- **WARNING:** To prevent fire or shock hazards, do not expose this unit to rain or moisture.
- **CAUTION:** Use of controls or adjustments or performance of procedures other than those specified may result in hazardous radiation exposure.
- **WARNING:** Changes or modifications to this unit not expressly approved by the party responsible for compliance could void the user's authority to operate the equipment.
- **WARNING:** Do not place the unit on top of any soft, porous, or sensitive surfaces to avoid damaging the surface. Use a protective barrier between the unit and surface to protect the surface.
- **WARNING:** Use of this unit near fluorescent lighting may cause interference regarding use of the remote. If the unit is displaying erratic behavior move away from any fluorescent lighting, as it may be the cause.
- **CAUTION:** Danger of explosion if battery is incorrectly replaced. Replace only with the same or equivalent type.
- **PRÉCAUTION:** *Danger d'explosion si les piles sont remplacées de façon incorrect. Remplacer les piles seulement par le même type de pile ou l'équivalent.*
- **WARNING:** There is a danger of explosion if you attempt to charge standard Alkaline batteries in the unit. Only use rechargeable NiMH batteries.
- **WARNING:** The remote control's button cell battery contains mercury. Do not put in the trash, instead recycle or dispose of as hazardous waste.
- **WARNING:** Lithium ion batteries, like all rechargeable batteries are recyclable and should be recycled or disposed of in normal household waste. Contact your local government for disposal or recycling practices in your area. They should never be incinerated since they might explode.

Main plug is used as disconnect device and it should remain readily operable during intended use.

Do not mix old and new batteries.

Do not mix alkaline, standard (carbon-zinc), or rechargeable (ni-cad, ni-mh, etc) batteries.

No mezcle baterias viejas y nuevas.

No mezcle baterias alcalinas, estándar (carbone-zinc) o recargables (ni-cad, ni-mh, etc.).

CAUTION
RISK OF ELECTRIC SHOCK
DO NOT OPEN

WARNING: TO REDUCE THE RISK OF ELECTRIC SHOCK, DO NOT REMOVE COVER (OR BACK). NO USER-SERVICEABLE PARTS INSIDE. REFER SERVICING TO QUALIFIED SERVICE PERSONNEL.



The lightning flash with arrowhead symbol, within an equilateral triangle, is intended to alert the user to the presence of uninsulated "dangerous voltage" within the product's enclosure that may be of sufficient magnitude to constitute a risk of electric shock to persons.



The exclamation point within an equilateral triangle is intended to alert the user to the presence of important operating and maintenance (servicing) instructions in the literature accompanying the appliance.



This product utilizes a Class 1 laser to read Compact Discs. This Laser Compact Disc Player is equipped with safety switches to avoid exposure when the CD door is open and the safety interlocks are defeated. Invisible laser radiation is present when the CD Player's lid is open and the system's interlock has failed or been defeated. It is very important that you avoid direct exposure to the laser beam at all times. Please do not attempt to defeat or bypass the safety switches.

IMPORTANT SAFETY INSTRUCTIONS

1. Read these Instructions.
2. Keep these Instructions.
3. Heed all Warnings.
4. Follow all instructions.
5. Do not use this apparatus near water.
6. Clean only with a dry cloth.
7. Do not block any ventilation openings. Install in accordance with the manufacturer's instructions.
8. Do not install near any heat sources such as radiators, heat registers, stoves, or other apparatus (including amplifiers) that produce heat.
9. Do not defeat the safety purpose of the polarized or grounding - type plug. A polarized plug has two blades with one wider than the other. A grounding type plug has two blades and a third grounding prong. The wide blade or the third prong are provided for your safety. When the provided plug does not fit into your outlet, consult an electrician for replacement of the obsolete outlet.
10. Protect the power cord from being walked on or pinched particularly at plugs, convenience receptacles, and the point where they exit from the apparatus.
11. Only use attachments/accessories specified by the manufacturer.
12. Use only with a cart, stand, tripod, bracket, or table specified by the manufacturer, or sold with the apparatus. When a cart is used, use caution when moving the cart/apparatus combination to avoid injury from tip-over.
13. Unplug this apparatus during lightning storms or when unused for long periods of time.
14. Refer all servicing to qualified service personnel. Servicing is required when the apparatus has been damaged in any way, such as power-supply cord or plug is damaged, liquid has been spilled or objects have fallen into the apparatus, the apparatus has been exposed to rain or moisture, does not operate normally, or has been dropped.



FCC Warnings

NOTE: This equipment has been tested and found to comply with the limits for a Class B digital device, pursuant to Part 15 of the FCC Rules. These limits are designed to provide reasonable protection against harmful interference in a residential installation. This equipment generates, uses, and can radiate radio frequency energy and, if not installed and used in accordance with the instructions, may cause harmful interference to radio communications. However, there is no guarantee that interference will not occur in a particular installation. If this equipment does cause harmful interference to radio or television reception, which can be determined by turning the equipment off and on, the user is encouraged to try to correct the interference by one or more of the following measures:

- Reorient or relocate the receiving antenna.
- Increase the separation between the equipment and receiver.
- Connect the equipment into an outlet on a circuit different from that to which the receiver is connected.
- Consult the dealer or an experienced radio/TV technician for help.

Additional Warnings

- The apparatus shall not be exposed to dripping or splashing and that no objects filled with liquids, such as vases, shall be placed on apparatus.
L'appareil ne doit pas être exposé aux écoulements ou aux éclaboussures et aucun objet ne contenant de liquide, tel qu'un vase, ne doit être placé sur l'objet.
- Main plug is used as disconnect device and it should remain readily operable during intended use. In order to disconnect the apparatus from the mains completely, the mains plug should be disconnected from the mains socket outlet completely.
La prise du secteur ne doit pas être obstruée ou doit être facilement accessible pendant son utilisation. Pour être complètement déconnecté de l'alimentation d'entrée, la prise doit être débranchée du secteur.
- Battery shall not be exposed to excessive heat such as sunshine, fire or the like.
Les piles ne doivent pas être exposées à de forte chaleur, tel qu'à la lumière du soleil, au feu ou autres choses de semblable.
- Caution marking is located at the bottom of apparatus.
Les précautions d'emploi sont inscrites en bas de l'appareil.
- The marking information is located at the bottom of apparatus.
Les marquages sont inscrits en bas de l'appareil.

Remote Battery Power

Requires 1 CR2025 battery (pre-installed).

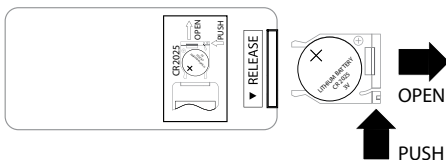

What's Included

- BD717
- Remote Control
- RCA Audio/Video Cable
- Microphone
- Detachable AC Cord

Features

- DVD player: DVD, DVD ± R/RW, CD, CD-R/RW, CD+G, JPEG CD
- AM/FM stereo radio
- 7" TFT LCD screen with on/off switch
- USB Thumb Drive Connection
- Remote
- Integrated stereo speakers
- DBBS: Dynamic bass boost system
- Aspect ratio: 16:9/4:3
- Moveable feet to adjust viewing angle
- Composite video output
- Digital audio coaxial output
- Optical digital output
- Stereo headphone jack
- Dual 3.5mm mic jacks
- DC power: requires 8 C batteries (not included)
- AC power: detachable AC cord

AC Power

Power the portable DVD stereo system by connecting it to a standard AC outlet using the detachable AC power cord.

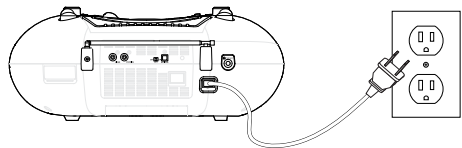

DC Battery Power

Requires 8 C batteries (not included).

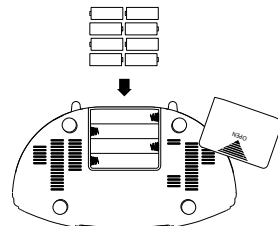

INTRODUCTION

DVD/Off/Radio

Turn to switch between *DVD*, *Off*, and *Radio* modes.

Volume

Turn to adjust the volume.

DBBS

Press to activate the Dynamic Bass Boost System.

USB/DVD

In *DVD* mode, press to switch between *DVD* and *USB* modes.

Next/Prev

Press to skip forwards or backwards through tracks or chapters on a loaded CD or DVD.

Power Indicator

Illuminates when the portable DVD stereo system is powered on.

FM St. Indicator

Illuminates when the FM radio is tuned to a FM stereo station.

AM/FM/FM ST.

Turn to switch between *AM*, *FM*, or *FM ST.* radio modes.

Tuning

Turn to adjust the *AM*, *FM*, or *FM ST.* radio frequency.

Play/Pause

Press to play or pause a loaded CD or DVD.

Stop

Press to stop a CD or DVD during play.

Reverse/Forward

Press to search forwards or backwards through tracks or chapters on a loaded CD or DVD.

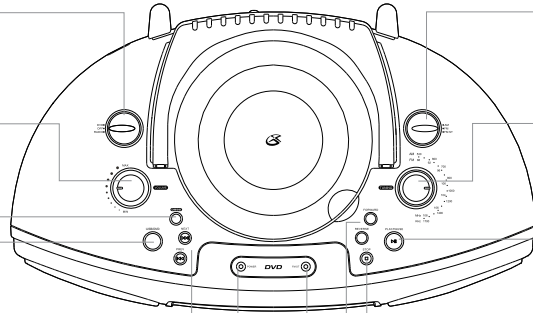

Display

Remote Receiver

Microphone Inputs

Use to connect one or two microphones.

Mic Level

Turn to adjust the volume of audio input from the connected microphone(s).

USB Thumb Drive Connection

Use to connect an external hard drive or USB flash drive.

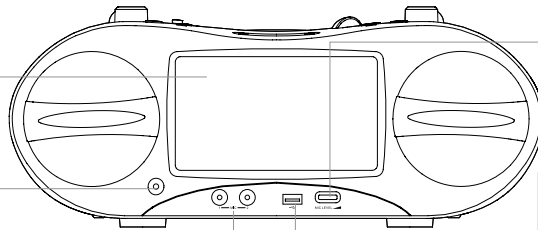

FM Antenna

Extend and adjust to improve FM radio reception. An AM Antenna is built into the unit.

Coaxial Digital Audio Output

Use to output high quality digital audio to an external stereo system.

TFT ON/OFF

Press to turn the display on and off.

Optical Digital Output

Use to output high quality digital audio to an external stereo system.

Video Output

Use to connect the portable DVD stereo system to a television.

Headphone Jack

Use to connect a set of headphones or earbuds to the portable DVD stereo system.

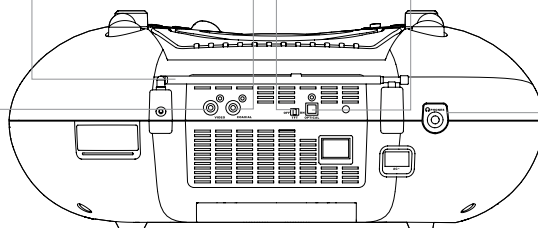

USB/DVD

In DVD mode, press to switch between DVD and USB modes.

A-B Repeat

Press to repeat a specified section of a loaded DVD.

Repeat 1/All

Press to repeat tracks or chapters from a loaded CD or DVD.

Menu

Press to access the DVD menu.

Subtitle

Press to cycle through the available subtitle languages for the loaded DVD.

Title

Press to view the title menu for the loaded DVD.

Audio

Press to cycle through the available audio languages for the loaded DVD.

Angle/Wide

Press to view alternate angles on a loaded DVD when available. Press and hold to adjust the screen mode to 4:3LB, 4:3PS, or 16:9.

F.BWD/F.FWD

Press to search forwards or backwards through tracks or chapters on a loaded CD or DVD.

Display

Press to view the on-screen display.

Setup

Press to view the portable DVD stereo system's setup menu.

Mute

Press to mute the volume.

Number Keypad**Clear**

Press to erase numbers entered using the number keypad.

Program

Press to program a loaded CD or DVD to play titles, chapters, or tracks in a specified order.

Zoom

Press to zoom in and out on a loaded DVD.

Select/Directional (◀▶▶▶▶)

Press to navigate a loaded DVD menu or the setup menu and make selections.

Slow

Press to view the loaded DVD in slow motion.

Next/Prev

Press to skip forwards or backwards through tracks or chapters on a loaded CD or DVD.

Stop

Press to stop a CD or DVD during play.

Pause/Step

Press to pause a CD or DVD during play. Press repeatedly to skip through frames on a loaded DVD one by one.

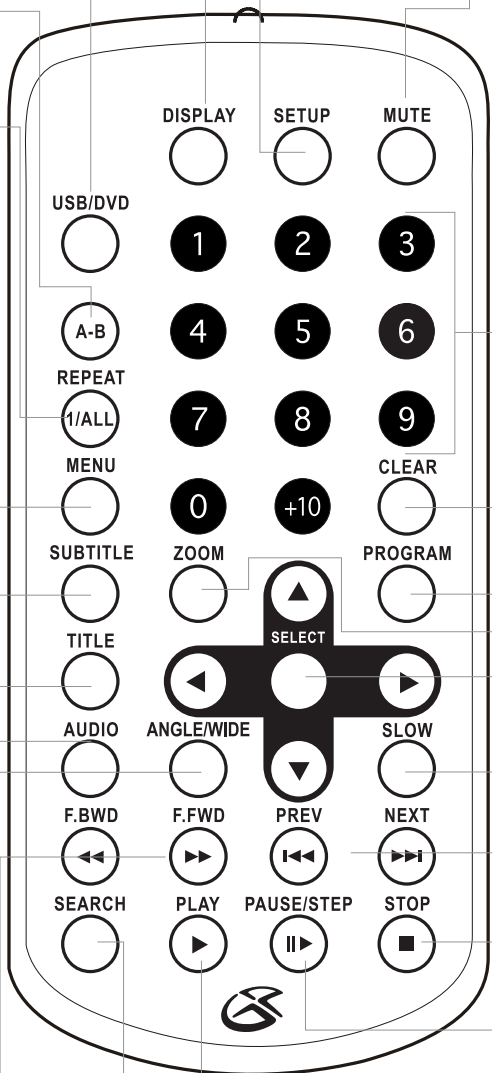
**Search**

Press to search to a specified title, chapter, or time on a loaded DVD.

Play

Press to play a loaded CD or DVD.

OPERATIONS

Using the Video Output

When connecting two products using an RCA Cable, match the colored ports with the same colored connection. (Yellow to Yellow)

1. Plug one end of the RCA Video Cable (included) into the **Video Output** on the unit.
2. Plug the other end of the RCA Video Cable (included) into a video input on a television.
3. Set the television to the appropriate video input.

Video played through the unit will now appear on the connected television.

Playing a DVD or CD

1. Turn the **DVD/OFF/RADIO** dial to the DVD position.
2. Open the **DVD/CD** door, and insert the DVD or CD to be played.
3. Press the **Play** button to begin playing the loaded disc.

Tuning the AM/FM Radio

1. Turn the **DVD/OFF/RADIO** dial to the Radio position.
2. Turn the **AM/FM/FM St.** dial to the desired position.
3. Extend and adjust the **FM Antenna** to improve FM radio reception.

An AM Antenna is built into the unit. To improve AM reception, adjust the position of the unit.

4. Turn the **Tuning** dial to adjust the AM or FM radio station.
5. Turn the **Volume** dial to adjust the volume of audio output from the unit.

Programming a CD or DVD

1. Load a CD or DVD into the portable DVD stereo system.
2. Press the **Program** button on the remote.
3. Use the **Number Keypad** on the remote to enter a title and chapter for a DVD or a track number for a CD.
4. Enter the titles and chapters, or tracks in the order you want them to play.
5. After the desired titles and chapters, or tracks are programmed, press the **Play** button to begin playing the programmed list.

System Setup

TV System

NTSC

LCD Mode

Choose between 4:3 and 16:9 aspect ratio.

TV Type

Choose between 4:3 Pan Scan, 4:3 Letter Box, and 16:9 Wide Screen.

Default

Use to restore the portable DVD stereo system to it's original settings.

Exit Setup

Choose to exit the setup menu.

Language Setup

OSD Language

Choose to adjust the language of the on-screen display.

Audio Language

Choose to cycle through the available audio languages for the loaded DVD.

Subtitle Language

Choose to cycle through the available subtitle languages for the loaded DVD.

Menu Language

Choose to cycle through the available menu languages for the loaded DVD.

Exit Setup

Choose to exit the setup menu.

Audio Setup

Audio Output

Choose between SPDIF/OFF, SPDIF/RAW, or SPDIF/PCM.

Exit Setup

Choose to exit the setup menu.

Video Setup

Adjust the brightness, contrast, hue, and saturation of the display.

Exit Setup

Choose to exit the setup menu.

Speaker Setup

Downmix

Choose between LT/RT or Stereo.

Exit Setup

Choose to exit the setup menu.

COMPANY INFORMATION

International Support

To download this User's Guide in English, Spanish, or French, visit the support section at www.gpx.com.

Para transferir esta guía de usuario en inglés, español, o francés, visite la sección de la ayuda en www.gpx.com.

Pour télécharger ce guide de l'utilisateur en anglais, espagnol, ou français, visitez la section de soutien chez www.gpx.com.

Contact Information

Phone: 1-888-999-4215

Email: prodinfo@gpx.com

Parts Email: partsinfo@dpi-global.com

Website: www.gpx.com

Free Manuals Download Website

<http://myh66.com>

<http://usermanuals.us>

<http://www.somanuals.com>

<http://www.4manuals.cc>

<http://www.manual-lib.com>

<http://www.404manual.com>

<http://www.luxmanual.com>

<http://aubethermostatmanual.com>

Golf course search by state

<http://golfingnear.com>

Email search by domain

<http://emailbydomain.com>

Auto manuals search

<http://auto.somanuals.com>

TV manuals search

<http://tv.somanuals.com>