

PROFESSIONAL LINE

TriloG™ 1500

Model 4064 and 4064H

GARAGE DOOR OPENER

OPERATION AND MAINTENANCE MANUAL

Includes INTELLICODE® 2 Remote Control. Safe-T-Beam® System must be installed to close door.

Homelink® and Car2U® compatible.

For Answers and Assistance:

1.800.354.3643

or visit www.geniecompany.com

WARNING: To reduce the risk of injury to persons or damage to property – Use this opener only with a one piece or sectional door.

**SAVE THIS MANUAL FOR FUTURE REFERENCE.
INSTALLER: LEAVE THIS MANUAL WITH HOMEOWNER.**

Genie, Genie logo, Intellicode and Safe-T-Beam are registered trademarks and TriloG is a trademark of GMI Holdings, Inc., dba The Genie Company. Homelink® is a registered trademark of Johnson Controls Technology Company. Car2U® is a registered trademark of Lear Corporation. © 2010 The Genie Company PN# 37318500118, 12/2010

SAFETY INFORMATION

OVERVIEW OF POTENTIAL HAZARDS READ THIS SAFETY INFORMATION

CONVENTIONS USED IN THESE INSTRUCTIONS

Garage doors are large, heavy objects that move with the help of springs under high tension and electric motors. Since moving objects, springs under tension, and electric motors can cause injuries, your safety and the safety of others depend on you reading the information in this manual. If you have questions or do not understand the information presented, call your nearest trained door system technician or visit our website.

The following Safety Alert symbol and signal words are used throughout this manual to call attention to and identify different levels of hazard and special instructions.



This is the safety alert symbol. This symbol alerts you to potential hazards that can kill or hurt you and others. All safety messages will follow the safety alert symbol and the word "**DANGER**", "**WARNING**", or "**CAUTION**"



DANGER indicates an imminently hazardous situation which, if NOT avoided, will result in death or serious injury.

WARNING indicates a potentially hazardous situation which, if NOT avoided, could result in death or serious injury.

CAUTION indicates a potentially hazardous situation which, if NOT avoided, may result in injury or property damage.

The word **NOTE** is used to indicate important steps to be followed or important considerations.

IMPORTANT SAFETY INSTRUCTIONS READ AND FOLLOW ALL INSTRUCTIONS SAVE THESE INSTRUCTIONS

Potential Hazard	Effect	Prevention
	<p>WARNING</p> <p>Could result in Death or Serious Injury</p>	<p>Keep people clear of opening while Door is moving.</p> <p>Do NOT allow children to play with the Door Opener.</p> <p>Do NOT operate a Door that jams or one that has a broken spring.</p>
	<p>WARNING</p> <p>Could result in Death or Serious Injury</p>	<p>Turn OFF power before removing opener cover.</p> <p>When replacing cover, make sure wires are NOT pinched or near moving parts.</p> <p>Opener must be fully grounded.</p>
	<p>WARNING</p> <p>Could result in Death or Serious Injury</p>	<p>Do NOT try to remove, install, repair or adjust springs or anything to which door spring parts are fastened, such as, wood blocks, steel brackets, cables or other like items.</p> <p>Installations, repairs and adjustments must be done by a trained door system technician using proper tools and instructions.</p>

OPENER FEATURES



INTELLICODE® 2 Access Security System

A new generation superior encryption system that enhances the security of the door opener by continuously changing the access code each time the remote is used. The door opener responds to each new code only once. An access code copied from a working system and tried again will not control the door opener.



Wall Console, Series III

Operates door opener from inside garage. The Wall Console has an Indicator Light with: Open/Close, Sure-Lock™, and Independent Light Control buttons.



and **Car2U®** compatible. Refer to the programming instructions on page 10 and then follow the **HomeLink®** or **Car2U®** instructions in your car owner's manual.

SAFETY FEATURES



Safe-T-Beam® (STB) Non-Contact Reversing System

Puts an invisible beam across the door opening. The door stops and reverses to the full open position if anything passes through the beam. LED indicator lights on the powerhead and on the STBs provide a self diagnostic code if an operational problem exists.

Safe-T-Reverse® Contact Reversing System

Automatically stops and reverses a closing door within two seconds of contact with an object.

Automatic ForceGuard™ Control

Automatically sets the force required to fully open and close the door for maximum safety.

Watch Dog™ Monitoring System

Monitors the Safe-T-Beam® system to ensure proper functionality and will automatically stop and reverse a closing door if a problem is detected.



Manual Emergency Release

Manually releases door from door opener. Used during a power failure or other emergency to allow manual opening and closing of door.



SmartSet™ Electronic Programming

Easily adjust the programming to reduce opening speed to a desired rate, vary limits and force, and program new remotes.



Automatic Lighting System

Two bulb lighting system supplies up to 200 Watts of light for safer evening exits and entries. Turns **ON** when door is activated and automatically turns **OFF** 4 minutes later.



Integrated Motion Detection (Not available on all models)

Select units have motion detection built into the powerhead. Lights automatically turn **ON** when motion is detected for much safer movement through the garage. Lights will turn **OFF** after 4 minutes of no motion.

TABLE OF CONTENTS

Section	Page
Safety Information	2
Opener Features & Safety Features	3
Table of Contents	4
Installation	
Important Installation Instructions	5
1 Programming Limits & Force	6-7
<i>Contact Reverse Test</i>	8
2 Program IntelliCode® 2 Remote to Powerhead	9
<i>Programming HomeLink®, Car2U®, IntelliCode® 1 remotes or wireless keypads</i>	10
Reference	
3 Typical Installed Illustrations	11-13
<i>Powerhead & Rail Assembled View</i>	11
<i>Typical Sectional Door Installation</i>	12
<i>Typical One Piece Door Installation</i>	13
4 Overview of Powerhead Controls	13
5 Overview of Remotes and Options	15-16
<i>Lost or Stolen Remote - Clearing Memory</i>	15
<i>IntelliCode® Features</i>	16
<i>Previously Installed Openers</i>	16
6 Maintenance & Troubleshooting	17-26
<i>Important Safety Instructions</i>	17
<i>Routine Monthly Maintenance</i>	18
<i>Door Balance (Spring Tension)</i>	18
<i>Safe-T-Beam® System Check</i>	18
<i>Contact Reverse Test</i>	18
<i>Change Light Bulbs</i>	19
<i>Motion Detector - Overview</i>	19
<i>Reset - Open/Close Travel Limit</i>	19
<i>Carriage Engage/Disengage</i>	19
<i>Wall Console - Overview</i>	20
<i>Optional Dual Wall Console - Installation</i>	20
<i>Remote Battery Replacement</i>	21
<i>Speed Adjustment Guide</i>	22
<i>Force Adjustment Guide</i>	23
<i>Troubleshooting Guide - Operation</i>	24-25
<i>Troubleshooting Guide - Powerhead LEDs</i>	25
<i>Reference - Wiring Diagram</i>	26
Warranty	27

OPENER MUST BE INSTALLED WITH THE INCLUDED WALL CONSOLE.

Safe-T-Beam® SAFETY REVERSE SYSTEM MUST BE INSTALLED TO CLOSE DOOR.

Begin here after the opener's physical assembly and installation has been completed.

There are no assembly or installation steps included in this manual. Contact your Genie® Professional Dealer for an installation poster, if required, or visit www.geniecompany.com to download a PDF file.

The following mechanical assembly tasks must be completed before continuing.

- Powerhead and rail are bolted to each other (An illustration is shown on page 11)
Example illustrations of the following items are shown on pages 12 and 13
- Rail end is attached to a header bracket which is attached to the garage door header
- Powerhead is attached to a support frame suspended from the ceiling or ceiling joists
- Both pieces of door arms are assembled and are attached to the garage door
- Safe-T-Beam® sensors installed and wired
- Wall console installed and wired (*Shown on page 20*)
- Shuttle is engaged to Screw Drive Carriage (*An illustration is shown on page 11*)
- Powerhead is plugged into an approved power outlet

Begin programming by setting Limits (see next page.)

A PDF VERSION INSTALLATION POSTER IS AVAILABLE AT WWW.GENIECOMPANY.COM
OR CALL 1-800-35-GENIE TO OBTAIN AN EMAIL PDF FILE

IMPORTANT INSTALLATION INSTRUCTIONS

⚠ WARNING: To reduce the risk of severe injury or death:

1. **READ AND FOLLOW ALL SAFETY, INSTALLATION AND OPERATION INSTRUCTIONS.** (If you have questions or do not understand an instruction, call The Genie Company.)
2. Install only on a properly balanced **sectional** or **one piece** garage door. An improperly balanced door could cause severe injury. Have a trained door system technician make repairs or adjustments to cables, spring assemblies, and other hardware **before** installing the opener.
3. Remove all ropes and remove or make inoperative all locks connected to the garage door before installing opener.
4. Where possible, install the door opener **7 feet or more above** the floor. For products having an emergency release, mount the emergency release 6 feet above the floor.
5. **Do NOT** connect the opener to source of power until instructed to do so.
6. Locate the wall console:
 - Within sight of the garage door,
 - At minimum height of 5 feet so small children are not able to reach it, and
 - Away from all moving parts of the door.
7. Install the **Entrapment WARNING Label** next to the wall console in a prominent location.
8. After installing the opener, the door must reverse within 2 seconds when it contacts a 1-1/2 inch high object (or a 2 x 4 board laid flat) on the floor.

INFRARED PROTECTION FUNCTION

1. When garage door is opening, its movement will not be influenced if the Safe-T-Beam® is obstructed.
2. If the Safe-T-Beam® is obstructed before the garage door fully closes, the door will not close.
3. When the garage door is closing, if Safe-T-Beam® is interrupted by person or obstacle, the garage door will stop its downward travel and reverse automatically to its fully opened position.
4. Remove Safe-T-Beam® obstruction.
5. If the Safe-T-Beam® System fails, loses power, or is installed improperly, press and hold the wall console "open/close" button until the door reaches its fully closed position. If you release the "open/close" button on the wall console during the closing movement the door will reverse automatically to its fully opened position.

1 PROGRAMMING LIMITS & FORCE

(Continuing from Installation Poster if provided)

SETTING & TESTING LIMITS AND FORCE

The OPEN (UP) and CLOSE (DOWN) **Door Limit positions** are controlled by making adjustments using the panel located on the bottom of the powerhead. Begin with Step 1 and continue through Step 10. **Door Force** is set during the final Open/Close cycle of these steps. The powerhead will automatically set door speed at slow if the distance between limits is less than 6 feet. Once Limits and Force are set **DO NOT** use the  or  buttons to open or close door.

A) CLOSE DOOR TRAVEL LIMIT

NOTE: If shuttle has NOT been engaged to the carriage, do so now.

Please note that there is a 30 second timeout **between each** programming step. A programming timeout during these steps has occurred when **two RED flashing LEDs** appear. In the event of a timeout please restart at Step 1.

NOTE: If one or both LEDs come ON RED at this time, Limits programming menu was not entered properly. You must exit programming and restart. To exit the programming function wait **30 seconds** for the programming to time out.

WARNING

- Make sure doorway is in view and clear of obstacles and people to avoid injury or damage to property.
- **DO NOT** operate this unit from wall console before **LIMITS** and **FORCE** are set. Severe damage to the opener can occur.
- Shuttle **MUST** be engaged to carriage **BEFORE** setting limits. See Installation Poster (if provided) or refer to pages 11 and 19.



1

PRESS and HOLD

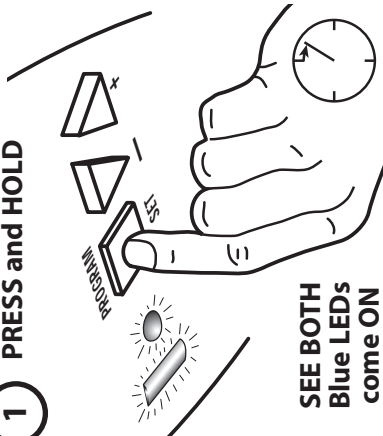

SEE BOTH Blue LEDs come ON

2

RELEASE

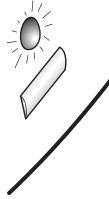

SEE round Blue LED come ON

3

PRESS and RELEASE

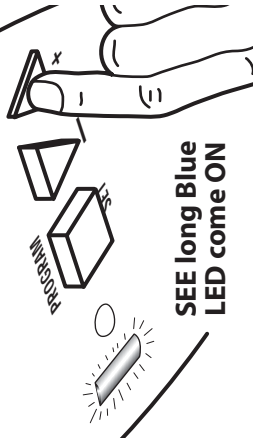

SEE long Blue LED come ON

If RED LED comes ON - STOP and exit programming.

3a

4

PRESS and RELEASE

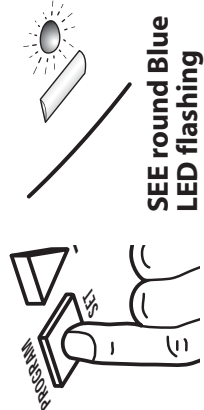

SEE round Blue LED flashing

5 PRESS and HOLD until door is FULLY CLOSED then RELEASE



Watch door move

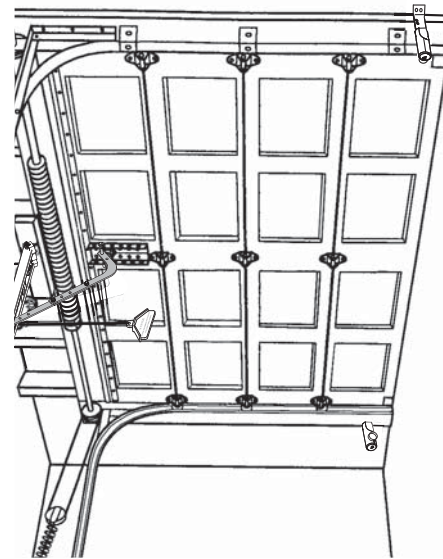
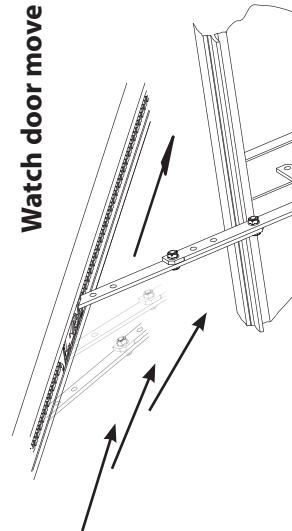

NOTE: You can start and stop door movement using either   buttons until door is in correct open or closed position.

6

PRESS and RELEASE

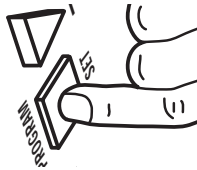

SEE long Blue LED flashing

B) OPEN DOOR TRAVEL LIMIT

7

PRESS and HOLD until door is FULLY OPEN then RELEASE

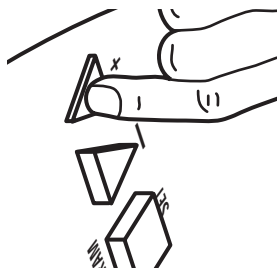

Watch door move

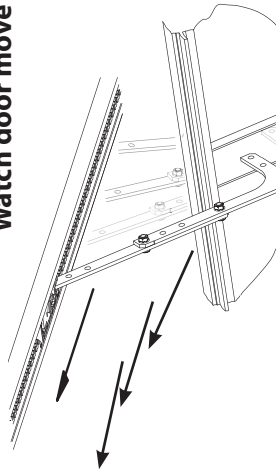

8

PRESS and RELEASE

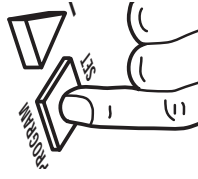

Door Limits are set.
Both LEDs flash Blue and go OFF.
Continue with Step 9 SET FORCE.

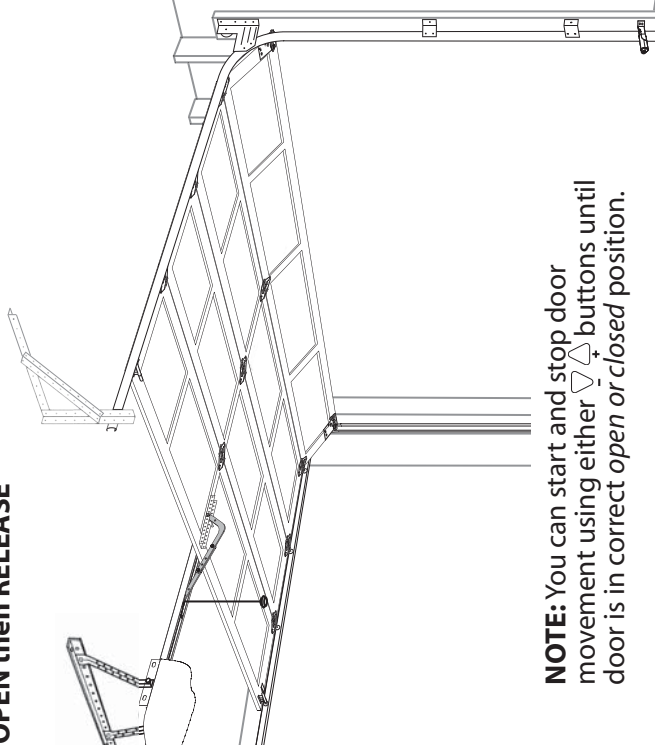

NOTE: You can start and stop door movement using either ∇ \triangle buttons until door is in correct *open or closed* position.

9

SET FORCE

Force is set automatically with first full CLOSE/OPEN door operation.

On Wall Console PRESS and RELEASE

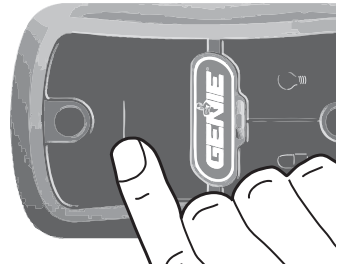

DOOR CLOSES

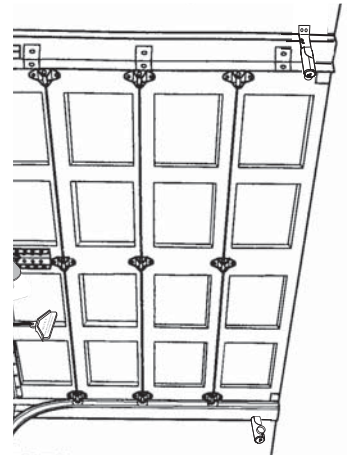

10

On Wall Console PRESS and RELEASE

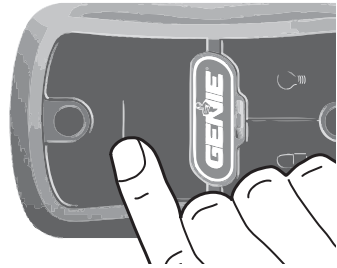

DOOR OPENS

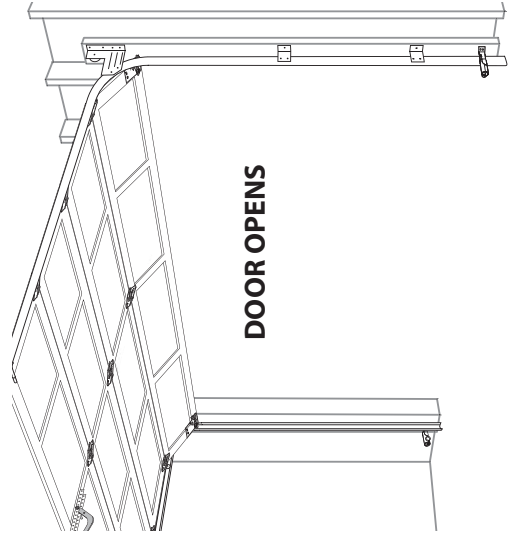

Perform a successful CONTACT REVERSE TEST and then continue with remote programming.

NOTE: To reset LIMIT settings, repeat Steps 1-10.

CONTACT REVERSE TEST

The Force and Limit settings on the previous page **MUST** be COMPLETED before Contact Reverse testing.

1. Test.

- Open garage door using wall console.
 - Place a 2" x 4" board (laid flat) under center of garage door opening.
- Close garage door using wall console.
- When door contacts board, the door must stop (within 2 seconds) and reverse direction returning to open position.

2. Adjustment.

- If the door:
 - Stops before it contacts the 2 x 4 board, it may simply be responding to an improperly set down limit. Return to pages 6-7 and repeat steps 1 through 10 to correct down limit.
 - Stops after contacting the 2 x 4 board and does not reverse it may need an adjustment to the down limit. Return to pages 6-7 and repeat steps 1 through 10 to correct down limit.
- Test again. Repeat as necessary until door reverses upon contacting board.

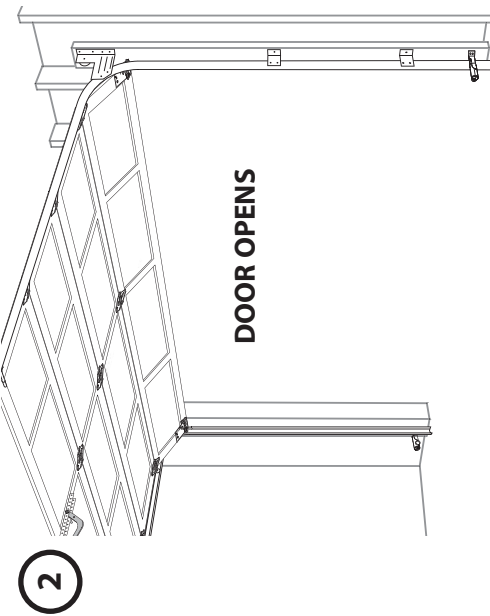

2

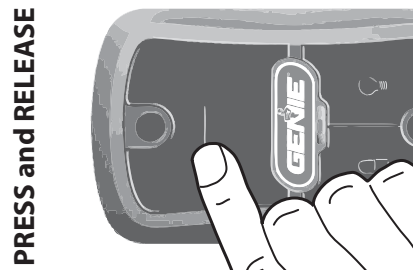

3

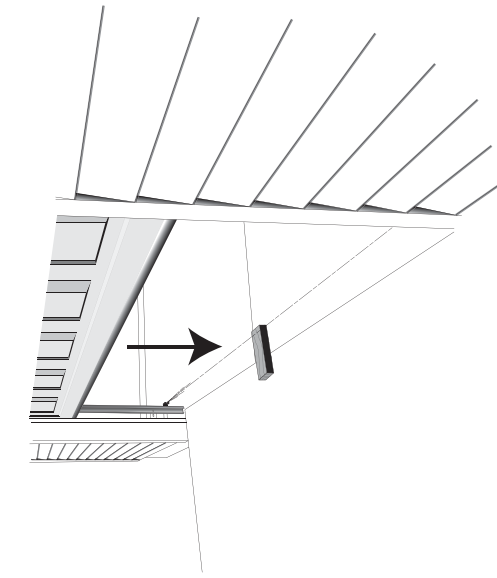

4

WARNING

A moving door can cause serious injury or death.

1. Keep people clear of opening while door is moving.
2. Do **NOT** allow children to play with opener, including wall console, remote, or wireless keypad.
3. During programming, door opener could begin to run, so stay away from moving door and its parts.

**On Wall Console
PRESS and RELEASE**

1

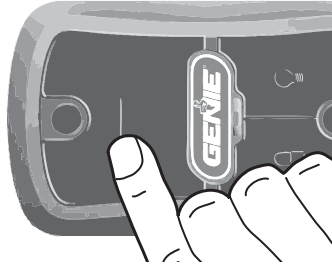

Once the Contact Reverse Testing is complete continue with Programming Remotes on the next page.

2 PROGRAM INTELLICODE® 2 REMOTE TO POWERHEAD

FOR HELP-1-800-35-GENIE OR WWW.GENIECOMPANY.COM

Bring remote(s) to powerhead location.

Begin with Step 1 and continue through Step 7 for each button to be programmed.

NOTE: The following instructions are for the remote(s) provided with this opener. This remote is preset for use with the **IntelliCode® 2** Access Security System. Refer to page 16 for additional information on **IntelliCode® 1** and **2** remotes and how to switch from **IntelliCode® 2** to **IntelliCode® 1**. See page 10 for programming instructions using **IntelliCode® 1** remotes.

⚠ WARNING

A moving door can cause serious injury or death.

1. Keep people clear of opening while door is moving.
2. Do **NOT** allow children to play with opener, including wall console, remote, or wireless keypad.
3. During programming, door opener could begin to run, so stay away from moving door and its parts.

1

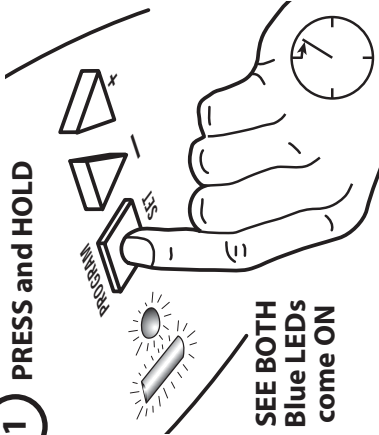

SEE BOTH
Blue LEDs
come ON

2

RELEASE



SEE round Blue
LED come ON

3

PRESS and
RELEASE

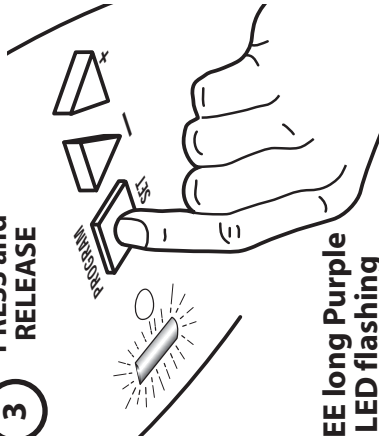

SEE long Purple
LED flashing

4

PRESS and
RELEASE

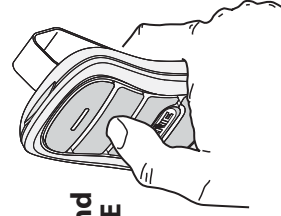

SEE both LEDs
flash Purple

5

PRESS and
RELEASE

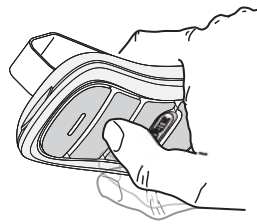

SEE both LEDs
flash Blue

6

SEE both LEDs OFF



7

PRESS and
RELEASE

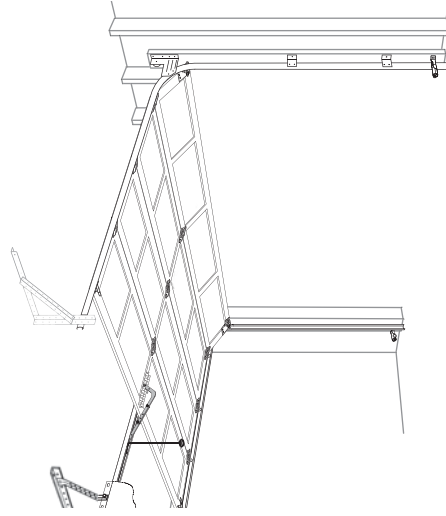
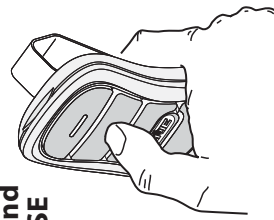

The next press of the remote will operate door.
Repeat as necessary for other remotes.

**Basic powerhead programming is complete.
Your garage door opener is ready to use.**

OPTIONAL PROGRAMMING POWERHEAD TO Homelink®, Car2U®, or IntelliCode® 1 REMOTES and IntelliCode® 1 WIRELESS KEYPADS

To complete any of these tasks you **MUST** have at least one Genie® IntelliCode® 2 remote button already programmed to the powerhead present.
For Homelink® or Car2U®: You must also have your Homelink® or Car2U® enabled vehicle present and their programming instructions to perform these programming steps.
For Genie® IntelliCode® 1 remote: You must also have your Genie® IntelliCode® 1 remote present.

For Genie® IntelliCode® 1 wireless keypad: You must also have your Genie® wireless keypad installed and a PIN already programmed into the keypad. Programming instructions for Genie® IntelliCode® 2 wireless keypad will come with the wireless keypad.

1 PRESS and HOLD

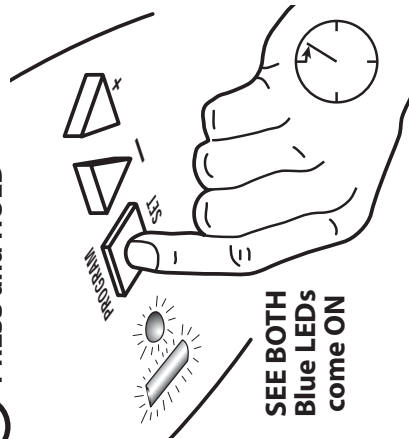

SEE BOTH Blue LEDs come ON

2 RELEASE

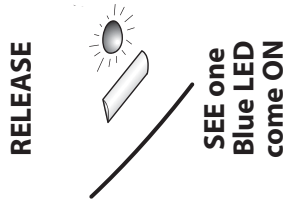

SEE one Blue LED come ON

3 PRESS and RELEASE

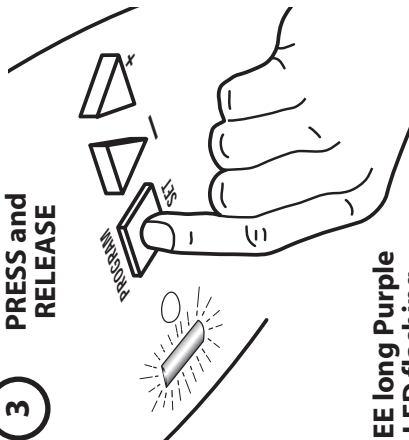

SEE long Purple LED flashing

4

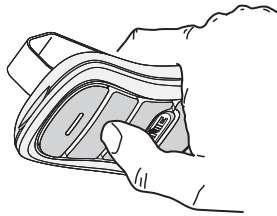

SEE both LEDs flash Purple

PRESS and release a previously programmed Genie® IntelliCode® 2 remote button on remote. If you are unsure which remote you have see page 16. Remote must be IntelliCode® 2 enabled.

Homelink® or Car2U® programming (for FIRST TIME Genie® users)

- 5** PRESS the Homelink® button **twice**.
- 6** Test. Repeat as necessary for any other *pre-programmed Homelink®* enabled vehicle.
- 5** For Car2U® enabled vehicles follow the Car2U® instructions.
- 6** Test. Repeat as necessary for any other Car2U® enabled vehicle.

IntelliCode® 1 remote or wireless keypad programming

Genie® IntelliCode® 1 wireless keypad

- 5** Enter your *wireless keypad* PIN.
- 6** Press and hold button 1 second then release and see *on powerhead* long LED come ON **Purple**.
- 7** Press and hold button 1 second again then release and see *on powerhead* both LEDs flash **Blue**.
- 8** Press and hold button again and opener will activate
- 9** Wait 30 seconds, enter pin and press button to verify operation.

Genie® IntelliCode® 1 remote

- 5** On the IntelliCode® 1 remote PRESS a button and RELEASE. SEE long LED come ON **Purple**.
- 6** On the IntelliCode® 1 remote PRESS the same button and RELEASE. SEE both LEDs on the *powerhead* come ON **Blue**. The next press of the remote will operate door.
- 7** Test. Repeat as necessary for any other IntelliCode® 1 remotes.

All optional programming is complete. Your garage door opener is ready to use.

3 REFERENCE - POWERHEAD & RAIL ASSEMBLED VIEW
RÉFÉRENCE - VUE DE LA TÊTE D'ALIMENTATION & DU RAIL ASSEMBLÉ
REFERENCIA - VISTA DEL CABEZAL ELÉCTRICO Y RIEL ENSAMBLADOS

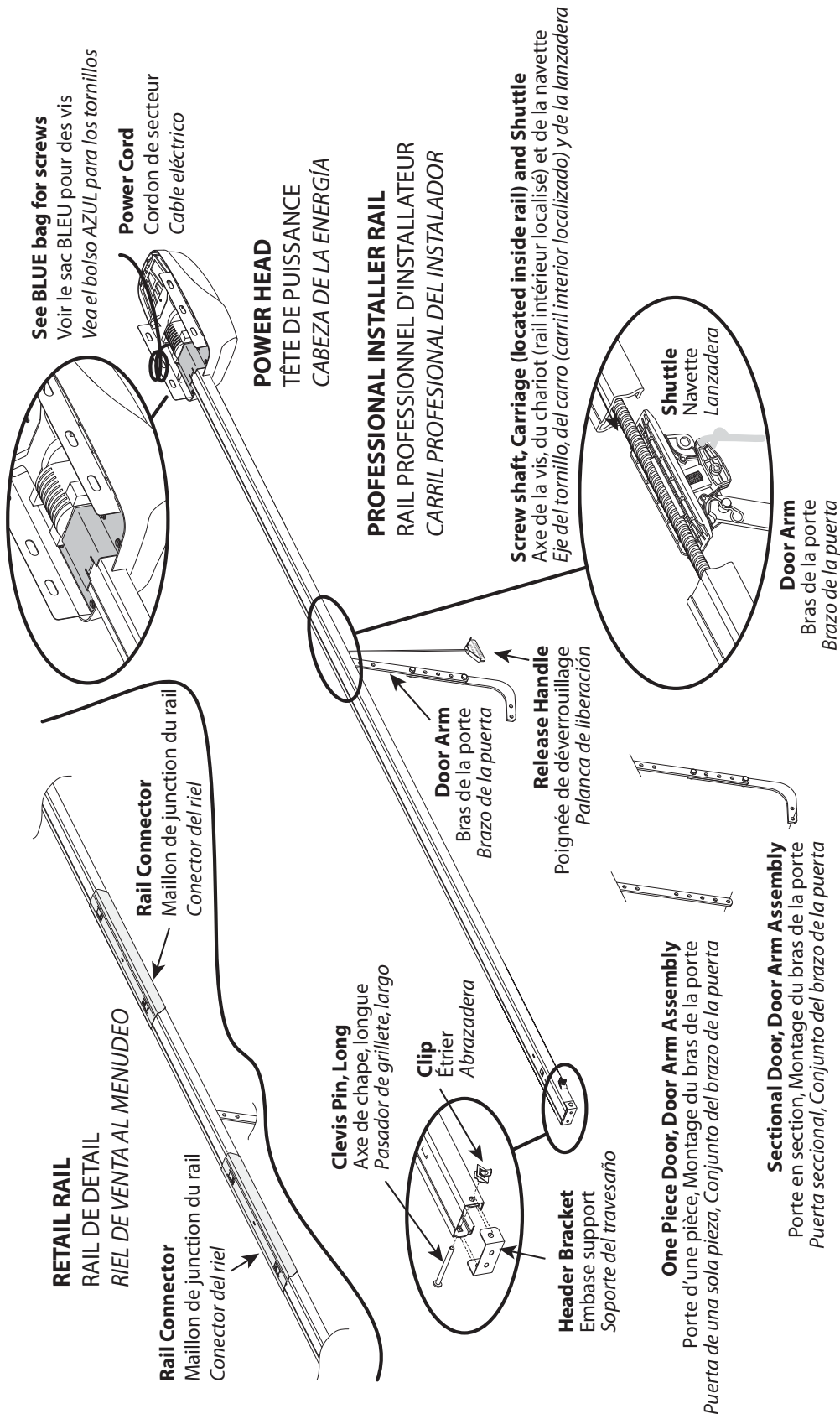

FIG. 3-3

NOTE: Use wall console and safety sensors provided with this unit. Do NOT substitute wall console or safety sensors.
 REMARQUE: Utilisez la console sur le mur et les capteurs de sécurité fournis avec cet appareil. NE PAS substituer la console du mur ou les capteurs de sécurité.
 NOTA: Use la consola de pared y los sensores de seguridad proporcionados con esta unidad. NO sustituya la consola de pared ni los sensores de seguridad.

TYPICAL SECTIONAL DOOR INSTALLATION FOR HELP-1-800-35-GENIE OR WWW.GENIECOMPANY.COM
INSTALLATION TYPIQUE SUR UNE PORTE SECTIONELLE POUR OBTENIR DE L'AIDE-1-800-35-GENIE
INSTALACIÓN HABITUAL DE UNA PUERTA SECCIONAL PARA OBTENER AYUDA, LLAME AL 1-800-35-GENIE

***If required direct wiring of power supply to opener must be installed by a licensed electrician. Power cord must reach grounded outlet without use of extension cord.**

****Le câblage direct de l'alimentation d'énergie à l'ouvreur doit être installé s'il y a lieu par un électricien autorisé. Le cordon de secteur doit atteindre la sortie au sol sans utilisation de corde de prolongation.**

*****Si es necesario, un electricista certificado debe instalar el cableado directo del suministro de energía al abre puertas. El cable eléctrico debe llegar al enchufe con conexión a tierra sin utilizar un cable de extensión.**

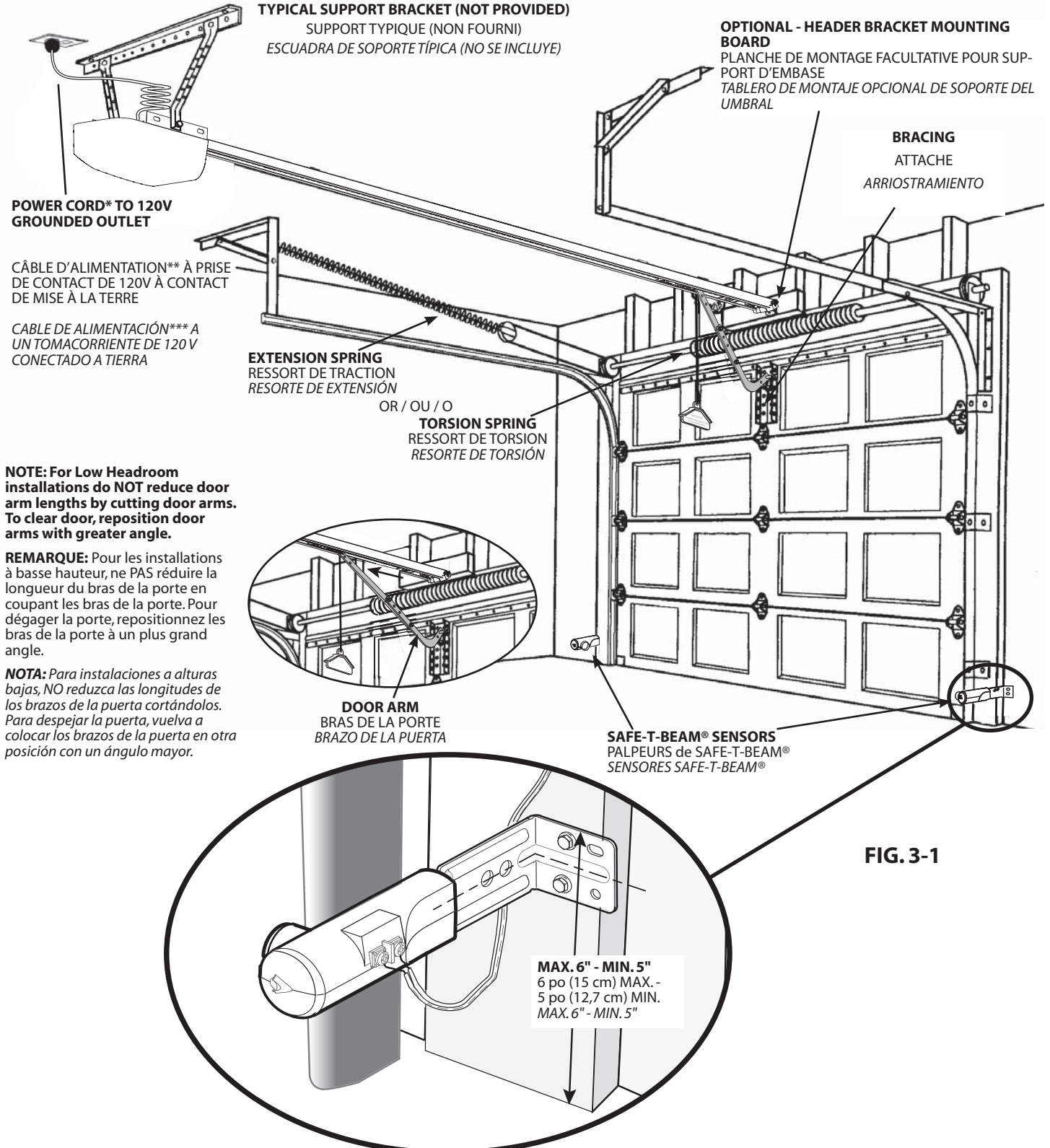

TYPICAL ONE PIECE DOOR INSTALLATION FOR HELP-1-800-35-GENIE OR WWW.GENIECOMPANY.COM
INSTALLATION TYPIQUE D'UNE PORTE DE GARAGE D'UNE PIÈCEPOUR OBTENIR DE L'AIDE-1-800-35-GENIE
INSTALACIÓN HABITUAL DE PUERTA DE UNA SOLA PIEZA..... PARA OBTENER AYUDA, LLAME AL 1-800-35-GENIE

***If required direct wiring of power supply to opener must be installed by a licensed electrician. Power cord must reach grounded outlet without use of extension cord.**

****Le câblage direct de l'alimentation d'énergie à l'ouvreur doit être installé s'il y a lieu par un électricien autorisé. Le cordon de secteur doit atteindre la sortie au sol sans utilisation de corde de prolongation.**

*****Si es necesario, un electricista certificado debe instalar el cableado directo del suministro de energía al abre puertas. El cable eléctrico debe llegar al enchufe con conexión a tierra sin utilizar un cable de extensión.**

TYPICAL SUPPORT BRACKET (NOT PROVIDED)

SUPPORT TYPIQUE (NON FOURNI)

ESCUADRA DE SOPORTE TÍPICA (NO SE INCLUYE)

HEADER BRACKET MOUNTING BOARD (not provided)

PLANCHE DE MONTAGE FACULTATIVE POUR SUPPORT D'EMBASE (non fourni)

TABLERO DE MONTAJE DE SOPORTE DEL UMBRAL (no se proporciona)

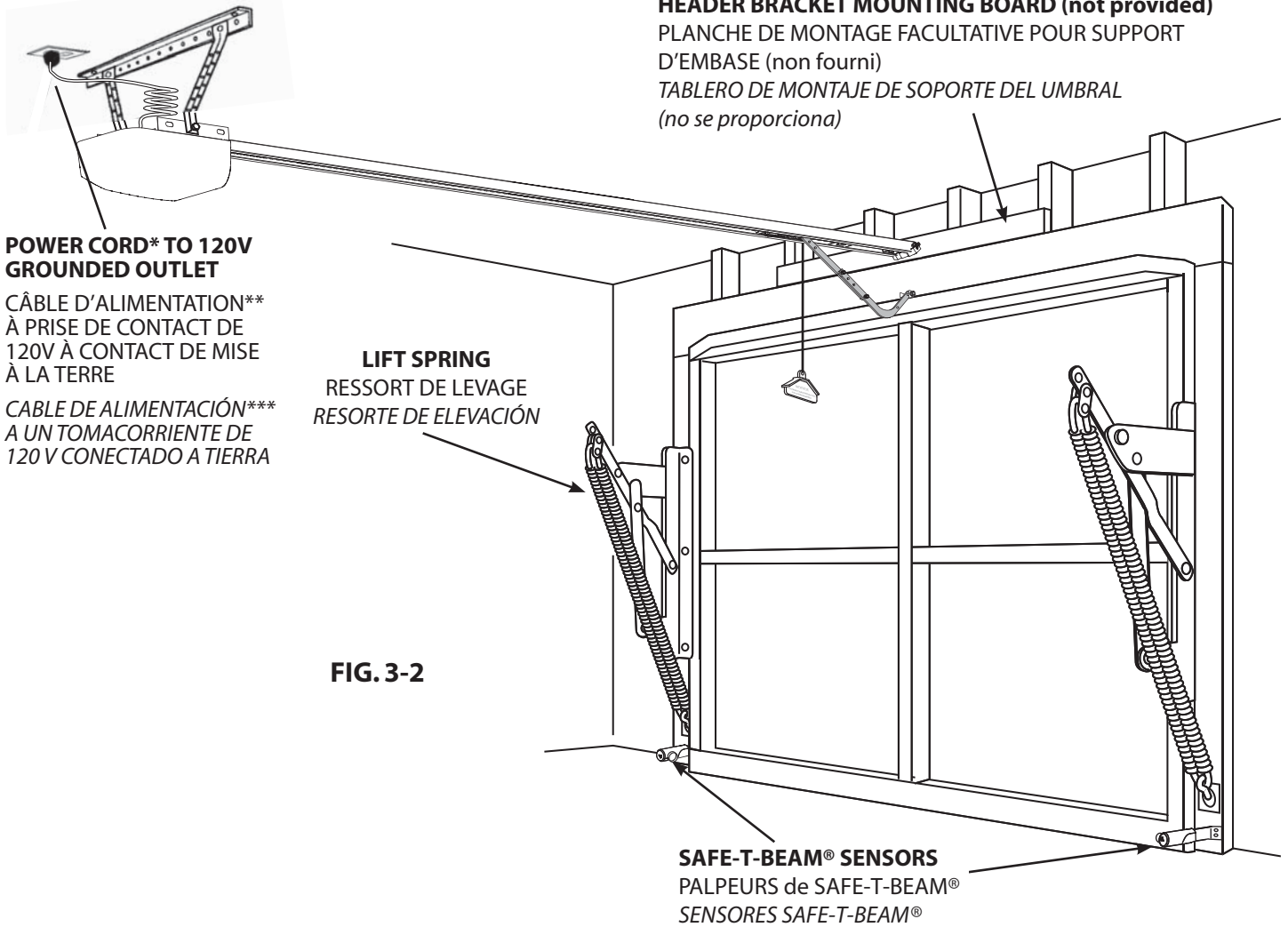

⚠ WARNING
To reduce the risk of injury to persons or damage to property - Use this opener only with a one piece or sectional door.

⚠ AVERTISSEMENT
 Pour diminuer le risque de blessures corporelles ou d'endommagement matériel - Utiliser cet l'ouvreur uniquement avec les portes à section.

⚠ ADVERTENCIA
 Para reducir el riesgo de lesión a las personas o daños a la propiedad - utilice este abre puertas solamente con una puerta de una pieza o seccional.

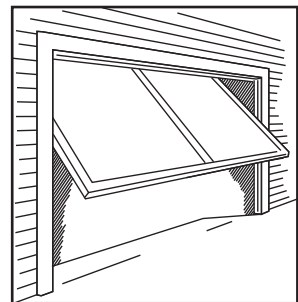

ONE PIECE DOOR
PORTE D'UNE PIÈCE
PUERTA DE UNA SOLA PIEZA

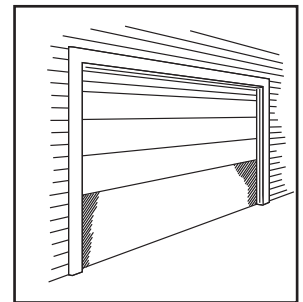

SECTIONAL DOOR
PORTE SECTIONELLE
PUERTA SECCIONAL

4 OVERVIEW OF POWERHEAD CONTROLS

This section describes the simple programming functions. Use this page to familiarize yourself with the buttons and LED indicators used to program the opener. **NOTE:** These \triangle and ∇ buttons are for programming use only. Do **NOT** use these buttons to operate the opener.

Programming buttons location on powerhead.

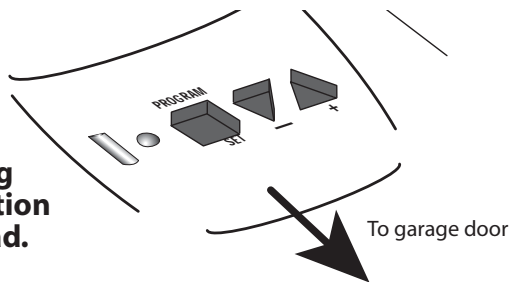

FIG. 4-1 Locate programming buttons

There are three programming buttons and two lights (LEDs) on the powerhead.

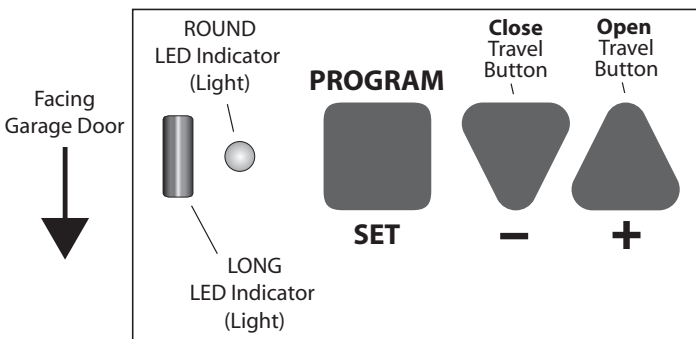

FIG. 4-2 Programming buttons

Each of the buttons are used to enter and complete the setup programming. The LEDs indicate status or a function change by illuminating ON, OFF, or ON *flashing* in one of three different colors: BLUE, RED, or PURPLE.

Throughout the instructions in this manual the buttons and LEDs are also displayed as icons.

Buttons

Name	Shape	Use
Program button		Enters into and selects programming menus
Close Travel button		multi-function; moves door, advances through menus
Open Travel button		multi-function; moves door, advances through menus

LED Colors

Round Red		and		Long Red
Round Purple		and		Long Purple
Round Blue		and		Long Blue

Programming Overview

There are four Powerhead program menus:

- Remote Program (Default menu)
- Limits Program
- Speed Program*
- Force Program*

Programming steps for Limits and remotes are found on pages 6 through 10.

*Force and Speed settings are set at the factory and do not normally require adjustment programming. Custom programming instructions for Speed and Force are located in the Troubleshooting Section of this manual.

These are the basic steps to enter into the four programming menus:

1. Press and hold until both BLUE lights come ON then release.
2. Both LEDs go out and Round BLUE light comes ON. You are in the Program Menus at the Remote Programming.

By using the \triangle or the ∇ button you can navigate to the Limits, Speed, or Force program menus and the LED display will change accordingly.

Each program menu has a specific LED display.

Press Program LED Display

Default	Remote	Round Blue
	Limits	Long Blue
X2	Speed	Round Blue & Long Blue
X3	Force	Round Red

3. Press button to enter into the program menu functions.

If you have entered into an unwanted program menu and are not sure where you are - do not press any buttons for 30 seconds. The programming function will time out after **30 seconds** if there is no key stroke activity.

5 OVERVIEW - REMOTES AND OPTIONS

WARNING

A moving door can cause serious injury or death.

1. Keep people clear of opening while door is moving.
2. Do **NOT** allow children to play with opener, including wall console, remote, or wireless keypad.
3. During programming, the door opener could begin to run, so keep people and objects away from the moving door and its parts. To keep the door from moving, close the door and disconnect it from the rail carriage by pulling the Emergency Release Handle. See page 19 for Release Handle operation.

Three Button Remote

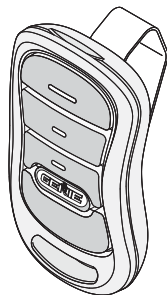

FIG. 5-1 Remote

See page 21 for battery changing instructions.



FCC and IC CERTIFIED

This device complies with FCC Part 15 and RSS 210 of Industry Canada. This equipment has been tested and found to comply with the limits for a Class B digital device, pursuant to Part 15 of the FCC Rules. These limits are designed to provide reasonable protection against harmful interference in a residential installation. This equipment generates, uses and can radiate radio frequency energy and, if not installed and used in accordance with the instructions, may cause harmful interference to radio communications. However, there is no guarantee that interference will not occur in a particular installation. If this equipment does cause harmful interference to radio or television reception, which may be determined by turning the equipment OFF and ON, the user is encouraged to try to correct the interference by one or more of the following measures:

- Re-orient or relocate the receiver antenna.
- Increase the separation between the opener and receiver.
- Connect the opener into an outlet on a circuit different from that to which the receiver is connected.
- Consult your local dealer.

LOST OR STOLEN REMOTE - CLEARING MEMORY

Clearing remotes from powerhead memory will clear ALL programmed remotes and wireless keypad.

NOTE: Follow the PROGRAM REMOTE TO POWERHEAD steps to re-enter remaining or new remotes. See page 9.

1. Press and hold until both lights come ON **BLUE**. Release button.

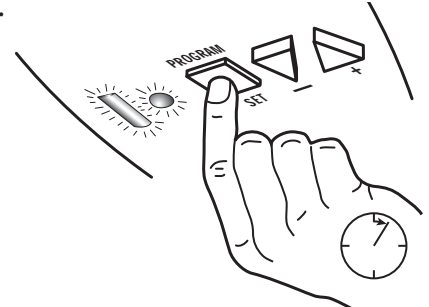

2. Lights go out and Round **BLUE** light comes ON.

3. Press again and long LED flashes **PURPLE**.

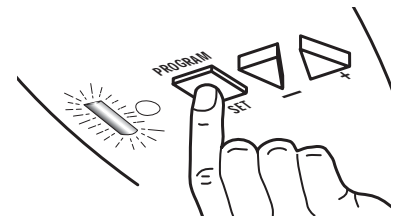

4. Press both and simultaneously on the powerhead and hold until both LEDs flash **BLUE**.

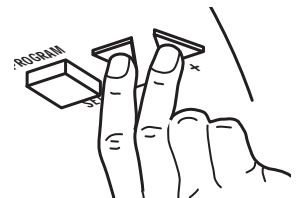

- Verify memory is cleared. Press a remote button that was previously programmed to the powerhead. Remote will not activate door opener.
- Garage door opener will operate normally using wall console.
- Program remaining or new remotes as shown on page 9. *Your door opener will no longer recognize any signal received from the missing remote, or any other which has not been reprogrammed to the powerhead.*



ATTENTION

If your garage door opener has a Serial Number sticker which looks like this, in which the first two numbers are 10 or higher, your opener is equipped with INTELLICODE®2.

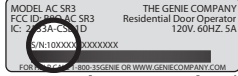

If you have another garage door opener that does NOT have a Serial Number like this, then you will be using the INTELLICODE® 1 setting on your remote to operate that opener.

INTELLICODE® FEATURES

Other models of Genie® garage door openers, remotes, and wireless keypads use **IntelliCode® 1** signals to communicate. Remote(s) provided with this unit will transmit either **IntelliCode® 1** or **IntelliCode® 2** signals.

Remote(s) contained in this package are preset to IntelliCode® 2 and can be configured to communicate with previously installed **IntelliCode® 1** openers. This dual **IntelliCode®** option allows one **IntelliCode® 2** remote to operate different models of The Genie Company garage door openers.

This new Genie® garage door opener will **ONLY** accept signals from a remote sending **IntelliCode® 2** signals (see page 9) or a Genie® brand **IntelliCode® 1** remote that has been programmed to the opener using a new **IntelliCode® 2** remote (see page 10).

NOTE: Other remotes not enabled with Genie® **IntelliCode® 2** will not operate this opener.

If you have ...	Use this IntelliCode® programming
One or more IntelliCode® 2 openers with a maximum 3 different openers	Use IntelliCode® 2
Mixture of openers manufactured between 1997 and 2010 (IntelliCode® 1) and new IntelliCode® 2 openers	Use IntelliCode® 2 and/or 1
One or more openers manufactured between 1997 and 2010 (IntelliCode® 1)	Use IntelliCode® 1

NOTE: A maximum of 3 different openers can be programmed to a 3 button remote.

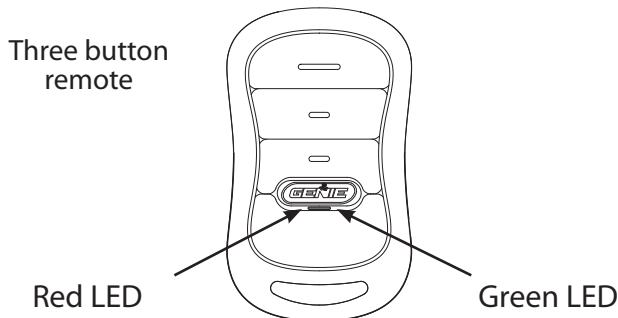

Programming remote to previously installed IntelliCode® 1 Genie® garage door openers

Remotes provided with this unit can operate other (**IntelliCode® 1**) models of Genie® garage door openers. The default **IntelliCode® 2** setting must be changed to **IntelliCode® 1**. (Follow these same steps to change **IntelliCode® 1** back to **IntelliCode® 2**.)

The LED color displayed on the remote indicates the IntelliCode® mode.

Red = IntelliCode® 1 / Green = IntelliCode® 2

1. Select a button on the remote that has NOT been programmed to the new powerhead.
2. Press and hold that button for **10 seconds**. **Both** Red and Green LEDs come ON and stay ON.

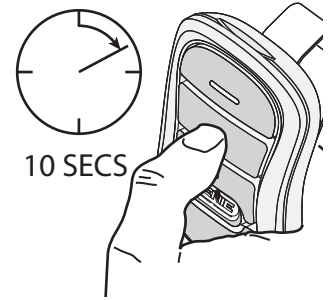

3. Press the same button **twice** to toggle **IntelliCode®** selection from **IntelliCode® 2** to **IntelliCode® 1**.

4. Press the same button **again** to confirm toggle. The **IntelliCode®** selection for this button is set to **IntelliCode® 1**.



5. Take the remote to the older Genie® garage door opener and follow that opener's instructions to program a new remote.

Repeat for other Genie® garage remote(s) as necessary.

TRANSMITTER COMPLIANCE STATEMENT

Transmitters comply with all United States and Canadian legal requirements as of the date of manufacture. No warranty is made that they comply with all legal requirements of any other jurisdiction. If transmitters are to be used in another country, the importer must determine compliance with any local laws and regulations which may differ from United States and Canadian requirements prior to use.

Los transmisores cumplen con todas las reglamentaciones legales de los Estados Unidos y del Canadá, en la fecha de fabricación. Ninguna garantía se da que cumplan con todas las reglamentaciones legales de ninguna otra jurisdicción. Si los transmisores se van a utilizar en otro país, el importador debe determinar si cumplen con las reglamentaciones y leyes locales que puedan ser diferentes a las reglamentaciones de los Estados Unidos y del Canadá, antes de usar los mismos.

Les émetteurs sont conformes à la réglementation américaine et canadienne à compter de leur date de fabrication. Aucune garantie n'est stipulée indiquant qu'ils sont conformes à toutes les prescriptions juridiques d'autres autorités. Si les émetteurs sont utilisés dans d'autres pays, il incombe à l'importateur d'en déterminer leur conformité aux lois et règles locales pouvant différer de celles des États-Unis et du Canada avant toute utilisation desdits émetteurs.

Sendegeräte entsprechen allen gesetzlichen Bestimmungen in den USA und Kanada zum Zeitpunkt der Herstellung. Wir übernehmen keine Gewährleistung für die Einhaltung aller gesetzlichen Bestimmungen in anderen Ländern. Sollen Sendegeräte in anderen Ländern eingesetzt werden, so muss der Importeur vor dem Gebrauch sicherstellen, dass die Sendegeräte auch solchen lokalen Bestimmungen entsprechen, welche von den Bestimmungen der USA und Kanadas abweichen.

截止于制造日期,传动装置符合美国和加拿大的所有法律要求。不提供传动装置符合任何其他司法地区所有法律要求之担保。如果传动装置需在任何其他国家使用,进口商必须在使用之前确定装置符合与美国和加拿大要求不同之所有地方法规条例。

トランスミッターは、製造日付けのアメリカ合衆国及びカナダの法的条件に準拠します。しかしながら、トランスミッターがアメリカ合衆国及びカナダ以外の国の法的条件に準拠するかどうかは一切保証できません。トランスミッターがアメリカ合衆国及びカナダ以外の国で使用される場合、同製品の使用に先立つ法規制がこれらの国々と異なることがあるため、輸入者は同製品が輸入国の法規制に準拠することを確認しなければなりません。

트랜스미터들은 미국과 캐나다 전역에서 제조 날짜를 명기해야 하는 요구사항에 따라야 합니다. 기타 다른 관할권의 모든 법적인 요구 사항에 따라야 하는 책임은 없습니다. 만일 트랜스미터들이 기타 다른 지역에서 사용될 경우 수입업자는 사용하기에 앞서 미국과 캐나다와의 요구사항과는 다를지도 모르는 그 지역의 법과 조례에 따라야 할지의 여부를 결정해야 합니다.

6 MAINTENANCE & TROUBLESHOOTING

FOR HELP-1-800-35-GENIE OR WWW.GENIECOMPANY.COM

If you have any questions, please do not hesitate to contact customer service at: **1-800-35-GENIE**

IMPORTANT SAFETY INSTRUCTIONS

WARNING: To reduce the risk of severe injury or death:

1. **READ AND FOLLOW ALL INSTRUCTIONS.**
2. Never let children operate or play with the door controls. Keep the remote away from children.
3. Always keep the moving door in sight and away from people and objects until the door is completely closed. **NO ONE SHOULD CROSS THE PATH OF THE MOVING DOOR.**
4. **NEVER GO UNDER A STOPPED, PARTIALLY OPEN DOOR.**
5. Test opener monthly. The door **MUST** reverse on contact with a 1-1/2" high object (or a 2" x 4" board laid flat) at the center of the doorway on the floor. After adjusting either the force or the limit of travel, retest the door opener. Failure to adjust the opener properly may cause severe injury or death.
6. When possible, use the emergency release only when the door is closed. Use caution when using this release with the door open. Weak or broken springs are capable of increasing the rate of door closure and increasing the risk of severe injury or death.
7. **KEEP DOORS PROPERLY BALANCED.** See your garage door Owner's Manual. An improperly balanced door increases the risk of severe injury or death. Have a trained door system technician make repairs to cables, spring assemblies, and other hardware.
8. **SAVE THESE INSTRUCTIONS.**

WARNING

- Garage door hardware (springs, cables, brackets, pulleys, etc.) are under extreme pressure and tension.
- DO NOT** attempt to repair or adjust door springs or any hardware, and **DO NOT OPERATE** garage door **automatically or manually** if door is improperly balanced or springs are broken.
 - CONTACT A TRAINED DOOR SYSTEM TECHNICIAN.**

ROUTINE MONTHLY MAINTENANCE

Basic monthly maintenance tasks.

- **Safe-T-Beam® System Check**
- **Door balance**
- **Contact reverse**

Instructions for these tasks and others are found on the following pages.

DOOR BALANCE (SPRING TENSION)

- With the door closed, pull  release handle DOWN and let go to release door carriage assembly from drive system.
- Raise door manually approximately 3'-4' and release.
 - Door should remain stationary or move very slightly.
 - If door moves quickly, **CONTACT A TRAINED DOOR SYSTEM TECHNICIAN.**
- Close the door.
- Verify shuttle arm is in the up position. (refer to page 19)
 - Operate door using remote or wall console.
 - Door will re-attach itself to carriage assembly.

WARNING

Use wall console supplied with opener. Other **approved** wall consoles may be available. Unapproved or incompatible wall consoles can cause the opener to operate unexpectedly.

Safe-T-Beam® (STB) SYSTEM CHECK

- STB Red and Green LEDs ON steady, system OK
- STB Red LED flashes
 - Check for obstruction
 - Check alignment
 - Verify wire routing from STBs to STB connection in powerhead
 - Check for signal interference from another Safe-T-Beam® unit
- No STB Red or Green LED displayed
 - Check wiring and wire connections

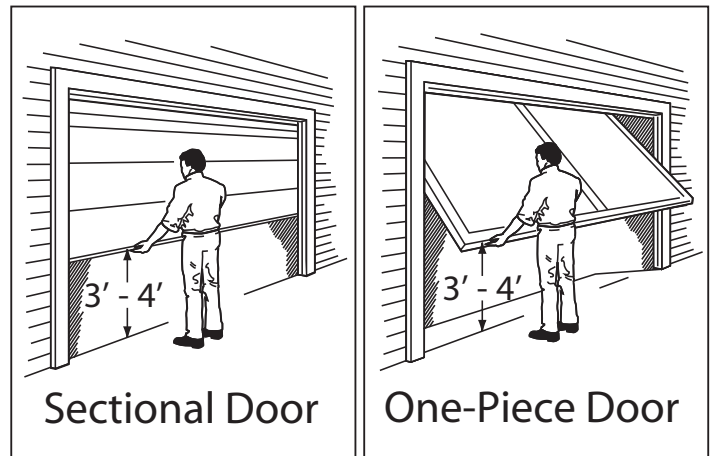
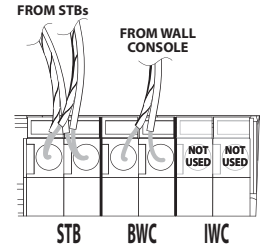

FIG. 6-1 Door balance

CONTACT REVERSE TEST (Monthly test)

The Force and Limit settings **MUST** be **COMPLETED** before testing. (See pages 6-7)

1. Test.

- Open garage door using wall console.
 - Place a 2" x 4" board (laid flat) under **center of garage door opening** (Fig. 6-2).
- Close garage door using wall console.
- When door contacts board, the door must stop (within 2 seconds) and reverse direction returning to open position.

2. Adjustment.

- If the door:
 - Stops before it contacts the 2 x 4 board, it may simply be responding to an improperly set down limit. Return to pages 6-7 and repeat steps 1 through 10 to correct down limit.

- Stops after contacting the 2 x 4 board and does not reverse, it may need an adjustment to the down limit. Return to pages 6-7 and repeat steps 1 through 10 to correct down limit.
- Test again. Repeat as necessary until door reverses upon contacting board.

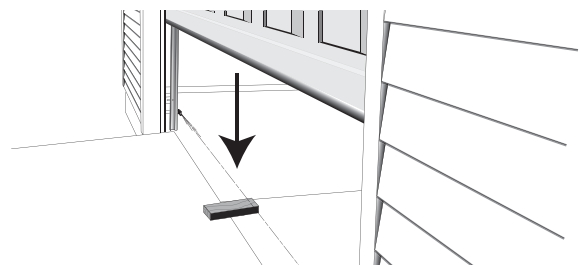

FIG. 6-2 2 x 4 under center of door opening



CHANGE LIGHT BULBS

WARNING

- Observe all safety warning and precautions! Improper light bulb removal or replacement could result in Death or Serious Injury.
- Disconnect power from opener before beginning this task.
- When replacing light cover, make sure wires are not pinched or near moving parts.

1. Disconnect power to door opener.

- Open powerhead light cover.
- Remove light bulb(s).
- Replace with maximum 100 Watt light bulb(s).
 - **Do NOT** use light bulbs with greater than 100 Watt rating.
- Close powerhead light cover.

2. Reconnect power to door opener.

- Test light operation.



MOTION DETECTOR* - OVERVIEW

(Not available on all models)

Powerheads equipped with a motion detector sensor provide additional security when exiting or entering the garage area.

*This sensor works by detecting body heat. Range of detection may be reduced when the temperature in the garage is close to body temperature.

NOTE: Detector positioning on the powerhead provides for monitoring *below* the powerhead.

OPERATION

- Detector sensor is always **ON**. There are **NO** user controls or adjustments.
- Lights automatically turn **ON** when a change is detected and will turn **OFF** after 4 minutes of no change.
- Motion detector sensor will not turn **OFF** lighting turned **ON** at the wall console.
- Lighting turned **ON** at the wall console will remain **ON** until wall console turns lighting **OFF** or opener is used.

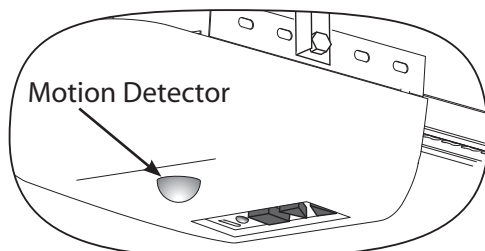

RESET - OPEN/CLOSE TRAVEL LIMIT

Performing **all ten (10) Limits/Force setting steps** (pages 6-7) erases previous Limits/Force settings.

NOTE: The opener will not close the door automatically unless the Safe-T-Beam® System is installed and Limits are programmed.

SHUTTLE ENGAGE/DISENGAGE

Use Release Handle to manually connect or release Shuttle from carriage and screw drive shaft.

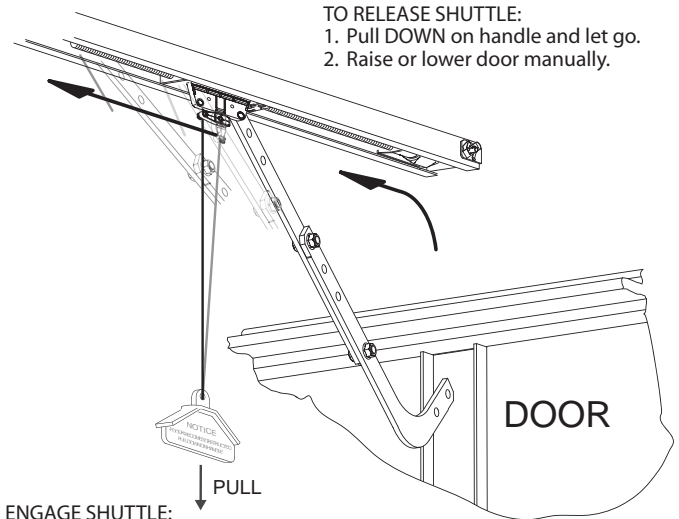

TO RELEASE SHUTTLE:

1. Pull **DOWN** on handle and let go.
2. Raise or lower door manually.

TO ENGAGE SHUTTLE:

1. Pull **DOWN** on handle and let go.
2. Raise or lower door using remote or wall console.

FIG. 6-3 Shuttle Release

This opener has a Serial Number sticker in which the serial numbers begin with 10 or higher.

ATTENTION

If your garage door opener has a Serial Number sticker which looks like this, in which the first two numbers are 10 or higher, your opener will operate using this Series III wall control.

MODEL AC SR3 THE GENIE COMPANY
 FCC ID: 2AFC SR3 Residential Door Operator
 IC: 2AFC SR3 120V, 60HZ, 5A
 SN: 10XXXX XXXXXXXX
 FOR INFO CALL 1-800-35GENIE OR WWW.GENIECOMPANY.COM

Follow the instructions on this page.

Wall consoles from other manufacturers may not work with openers of these serial number groups. Genie® Series I wall buttons and Series II wall consoles will not work with openers of this serial number group.

WALL CONSOLE - OVERVIEW

Use only the Series III wall console provided with this unit.

Wall console has three buttons and one indicator light.

Indicator Light

Indicator light will display Red when wall console is properly wired and Sure-Lock™ is OFF. When Sure-Lock™ is ON indicator light flashes.

Open/Close Button

Use this button to open or close garage door. When Sure-Lock™ is ON the Open/Close button will CLOSE door only. **Note:** Constant button pressure in the CLOSE mode will override error responses in the powerhead and close door.

Independent Light Control Button

Use this button to turn powerhead lights ON. Powerhead lighting will remain ON until this button is pressed again or a door action has been completed. **Note:** If opener has a Motion Detector sensor the sensor will keep powerhead lights ON as long as motion is detected.

Sure-Lock™ Button

When Sure-Lock™ is ON the powerhead cannot be activated by the wall console or a remote.

- Press and hold for 5 seconds (or until Indicator Light flashes) to activate Sure-Lock™.
- Press and release to turn Sure-Lock™ OFF.

Open/Close Button

Open and closes door from inside garage

Sure-Lock™ Button

- LOCK disables controls after door is completely closed
- UNLOCK allows controls to work normally

Indicator Light

Red indicator light is always ON
 When Sure-Lock™ is ON the indicator light flashes

Independent Light Control Button

Controls door opener lights from inside garage



Tip: If indicator light on wall console comes ON, but there is NO operation from buttons - verify wall console wire routing at powerhead connector.

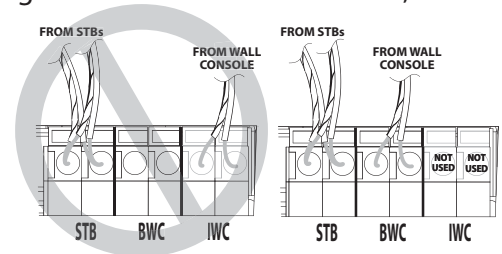

OPTIONAL DUAL WALL CONSOLE - INSTALLATION

Use only a Series III wall console when adding a second wall console. The optional second Genie® Series III wall console must be purchased separately.

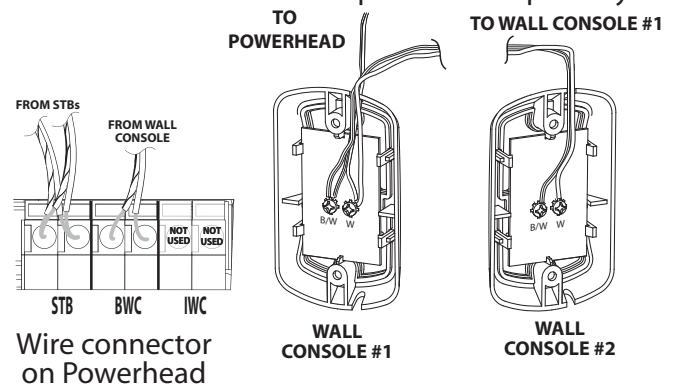

OR

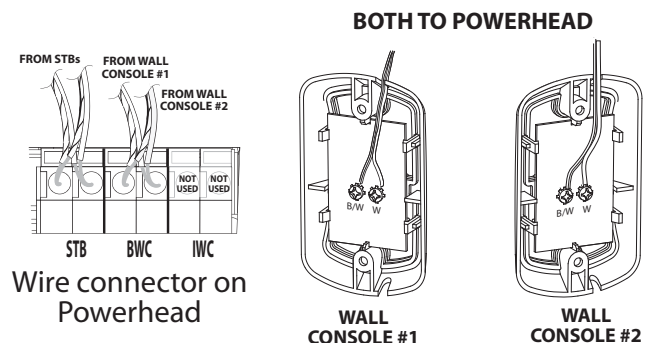

This area left blank

REMOTE BATTERY REPLACEMENT

Replace remote battery with a CR 2032 coin cell battery.

1. Open the remote case using a washer or coin that fits into the slot at the top of the remote.
2. Replace battery.
3. Align components and snap case closed.

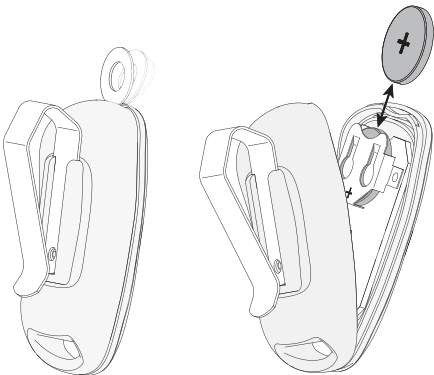

Speed settings are pre-programmed at the factory for the maximum speed. Speed settings should not need adjustment with this unit.









However, travel speed for the opener in both the *open* and *close* directions can be adjusted to slower speeds to minimize normal wear for heavy sectional doors.







NOTE: One piece doors are automatically set during Limits programming to the slowest speed and opener speed cannot be reset for one piece doors.

CHANGE SPEED SETTING

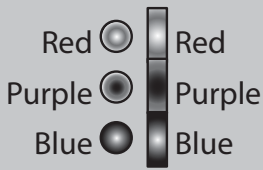
Use this guide to ADJUST powerhead SPEED settings.

There are three (3) Speed settings available on this unit for the *open* and *close* directions. Door type (one piece or sectional), door weight and balance, and condition of door components / track affect door speed. Speed adjustment may not be available for some installations depending on these factors.

1. Press  on the powerhead and hold until both lights turn steady ON. Release button. Lights go out and Round BLUE light comes ON.
2. Press  **two** times and the Round BLUE and Long BLUE lights come ON.
3. Press  once to enter the Speed Programming menu. The round LED will flash BLUE 3 times, then the *current* Speed setting **for UP travel** will display on the LEDs. See table below.
4. Press  to raise or  to lower **UP Speed settings** within the available range.
NOTE: Faster door speeds may not be available.
5. Press  to **set UP Speed level**. The long LED will flash BLUE 3 times, then the *current* Speed setting **for DOWN travel** will display on the LEDs.
6. Press  to raise or  to lower **DOWN Speed settings** within the available range.
NOTE: Faster door speeds may not be available.
7. Press  to **set DOWN Speed level**. Both LEDs flash BLUE to confirm.

Speed Level	Powerhead LEDs	
	Round LED	Long LED
Default LED display is the current Speed setting		
LED Speed indicator colors		
Speed Level LED indicator colors		
MAXIMUM	Red ON 	 Red ON
MID	Purple ON 	 Purple ON
SLOW	Blue ON 	 Blue ON

CAUTION

Door closing force is **FACTORY** set and requires no adjustment for *normal* operation.

- Never increase the door closing force to compensate for a damaged door or a binding door track.
- Never adjust force to compensate for a broken door spring.
- Perform monthly **CONTACT REVERSE TEST** as described on page 18.

Force settings are pre-programmed at the factory and "learned" during the Open/Close Limit settings steps. Some additional Force may be increased. For normal use, Force settings should not need adjustment with this unit.









However, conditions that might suggest an adjustment is necessary are;























- Doors with very stiff weather seals.
- Doors that start down, then **STOP** and reverse before they close.
- Doors that start up, but **STOP** before they completely open.

CHANGE FORCE SETTING

Use this guide to **ADJUST** powerhead **FORCE** settings.

NOTE: There are nine (9) force levels.

1. Press  on the powerhead and hold until both lights turn steady ON. Release button. Lights go out and Round **BLUE** light comes ON.
2. Press  **three** times, Round **RED** light comes ON.
3. Press  once to enter the Force Programming menu. The round LED will flash **BLUE** 3 times, then the *current* Force setting **for UP force** will display on the LEDs. See table below.
4. (If current UP Force setting is good, skip to Step 5.) Press  to increase or  to decrease **UP Force settings** within the available range.
5. Press  to **set UP Force level**. The long LED will flash **BLUE** 3 times, then the *current* Force setting **for DOWN force** will display on the LEDs.
6. (If current DOWN Force setting is good, skip to Step 7.) Press  to increase or  to decrease **DOWN Force settings** within the available range.
7. Press  to **set DOWN Force level**. Both LEDs flash **BLUE** to confirm.

Force Level	Powerhead LEDs	
	Round LED	Long LED
Default LED display is the <i>current</i> Force setting		
LED indicator colors  OFF,  Blue,  Purple,  Red		
Force Level LED indicator colors		
Force Level 1	Blue ON 	 OFF
Force Level 2	OFF 	 Blue ON
Force Level 3	Blue ON 	 Blue ON
Force Level 4	Purple ON 	 OFF
Force Level 5	OFF 	 Purple ON
Force Level 6	Purple ON 	 Purple ON
Force Level 7	Red ON 	 OFF
Force Level 8	OFF 	 Red ON
Force Level 9	Red ON 	 Red ON

PROBLEM	WHAT TO DO
<p>Opener does NOT run from wall console.</p>	<ul style="list-style-type: none"> • Check power source, <ul style="list-style-type: none"> – Plug a lamp into outlet used for powerhead. If lamp works, power source is OK. – If not, check fuse or circuit breaker. • If power is OK, <ul style="list-style-type: none"> – Check connections at powerhead terminals and at wall console. – Limits must be set with door arm connected to door. • Check if wall console Sure-Lock™ is ON. Turn Sure-Lock™ OFF & check operation. • Check for reversed, broken, or cut wires. Staples can cut insulation and short wires. Repair or replace.
<p>Opener runs, but door does NOT move.</p>	<ul style="list-style-type: none"> • Make sure carriage is engaged to shuttle. See pages 11 and 19. Refer to Installation poster or download poster from WWW.GENIECOMPANY.COM. <ul style="list-style-type: none"> – Ensure carriage is in engaged position. See page 19. • Check to make sure screw shaft is not broken or OUT of its drive sprocket. • Check FORCE ADJUSTMENT. See page 23.
<p>Opener works from wall console, but NOT from remote.</p>	<ul style="list-style-type: none"> • Check all remotes. • Replace remote battery with good one. See page 21. • Program remote to powerhead. See pages 9 or 10.
<p>Remote has less than 25 feet operating range or no operation.</p>	<ul style="list-style-type: none"> • Relocate remote inside car and or point remote at garage door. • Replace battery. See page 21. • Reposition door opener antenna. • Remote LED does not come ON with button push - replace battery. See page 21. • Eliminate possible competing signals (satellite radio, FiOS® TV).
<p>Door starts down, then STOPS and goes back up.</p> <p>OR</p> <p>Safe-T-Beam® System malfunction.</p>	<ul style="list-style-type: none"> • If a NEW installation, check Door Arm position. Refer to Installation poster or download poster from WWW.GENIECOMPANY.COM. • Check if Limits are properly set. See pages 6-7. • Check if Safe-T-Beam® Red LED is flashing. See page 18. • Check Safe-T-Beam® system for beam obstruction or misalignment of lenses. See page 18. • Check garage door for binding. • If an operational problem exists, and opener will not run closed. The opener can be forced to close as follows; Press and hold the wall console button until door is completely closed. • Check for interference from adjacent Safe-T-Beam® units. • Contact The Genie Company at 1-800-35-GENIE.
<p>Door starts down, then STOPS before it is closed.</p> <p>OR</p> <p>Door will only open.</p>	<ul style="list-style-type: none"> • Check Safe-T-Beam® wire connections at powerhead. See page 18. • Check Limits are properly set. See pages 6-7. • Check CONTACT REVERSE. See page 18. • Check garage door for binding. • Check <i>closing</i> "FORCE" adjustment. See page 23.
<p>Door starts up, but STOPS before it is completely open.</p>	<ul style="list-style-type: none"> • Check Limits are properly set. See pages 6-7. • Be sure door, opener, and springs are in good repair, properly lubricated and balanced. • Check opening "FORCE" adjustment. See page 23. • ▲ WARNING: If you suspect a problem with the garage door hardware or springs, contact The Genie Company at 1-800-35-GENIE.
<p>Door will only run closed.</p>	<ul style="list-style-type: none"> • Check Limits are properly set. See pages 6-7. • Check Sure-Lock™. Sure-Lock™ should be OFF for normal operation. See page 20. • Check door balance, condition, and door spring. • Check <i>opening</i> "FORCE" adjustment. See page 23. • ▲ WARNING: If you suspect a problem with the garage door hardware or springs, contact The Genie Company at 1-800-35-GENIE.
<p>Door opener starts for no reason.</p>	<ul style="list-style-type: none"> • Button stuck on wall console or remote. • Was a remote lost or stolen? Erase all remotes from powerhead memory and program new remotes. See page 15.

TROUBLESHOOTING GUIDE - OPERATION (CONTINUED)..... **FOR HELP-1-800-35-GENIE**

PROBLEM	WHAT TO DO
Noisy operation.	<ul style="list-style-type: none"> • Be sure all door fasteners are tight. • Be sure garage door is in good repair, properly lubricated and balanced. • Be sure opener is in good repair.
Door opener runs slow.	<ul style="list-style-type: none"> • Check operating condition of door. See pages 18. Door may need professional repair/adjustment. • Is this opener installed on a one piece door? Normal speed for one piece door is lowest speed setting. • If carriage travel is less than 6 feet, opener configures programming for a one piece door. • Check door speed. See page 22.

TROUBLESHOOTING GUIDE - POWERHEAD LEDs **FOR HELP-1-800-35-GENIE OR WWW.GENIECOMPANY.COM**

Powerhead LED		Possible Problem	Solution
Round LED	Long LED		
OFF	OFF	Normal operation	None required
		No response from unit	Check power supply Contact a trained door system technician
ON/RED/STEADY	ON/RED/STEADY	Limits NOT set properly	Reprogram Limits, see pages 6-7
ON/RED/FLASHING	ON/RED/FLASHING	Program error	Unplug unit, wait 5 seconds, plug in
		Component failure	Contact a trained door system technician
ON/BLUE/FLASHING	OFF	Remote NOT programmed	Program remote, see page 9
ON/PURPLE/FLASHING	OFF	IntelliCode® 1 remote NOT programmed	Program remote using IntelliCode® 2 remote, see page 9, then program IntelliCode® 1 remote using instructions on page 10
ON/RED/FLASHING	OFF	Safe-T-Beam® physical obstruction	Remove obstruction, recheck unit
		Safe-T-Beam® signal interference	Check alignment of Safe-T-Beam® pair and nearest other Safe-T-Beam® pair
OFF	ON/RED/FLASHING	Door contact in up or down travel	Remove obstruction
		Door component failure detected	Check door spring, track, rollers, hinges and fixtures
OFF	ON/RED/STEADY	Thermal cutout	DO NOT unplug unit Wait until LED clears before operating

REFERENCE - CIRCUIT WIRING DIAGRAM

FOR HELP-1-800-35-GENIE OR WWW.GENIECOMPANY.COM

RÉFÉRENCE - DIAGRAMME DE CÂBLAGE DE CIRCUITPOUR OBTENIR DE L'AIDE-1-800-35-GENIE

REFERENCIA - ESQUEMA ELÉCTRICO DEL CIRCUITO PARA OBTENER AYUDA, LLAME AL 1-800-35-GENIE

Opener circuit wiring diagram. This wiring diagram is for reference only.

Schéma de câblage de l'ouvreuse. Ce schéma de câblage est indiqué à titre de référence uniquement.

Diagrama del circuito del operador. Este diagrama es sólo para referencia.

WARNING

AVERTISSEMENT

ADVERTENCIA

Opening Cover May Cause Electric Shock.

L'ouverture du couvercle peut entraîner des chocs électriques.

Abrir la tapa puede causar choques eléctricos.

Disconnect power from opener prior to removing cover.

Coupez l'alimentation de l'ouvre-porte avant de retirer le couvercle.

Desconecte la electricidad del abrepuertas antes de quitar la cubierta.

POWER CORD

CORDON DE SECTEUR
CABLE ELÉCTRICO

Reference for licensed electrician use

Référence pour l'usage autorisé d'électricien

Referencia para el uso autorizado del electricista

CONNECTOR
CONNECTEUR
CONECTADOR

PRINTED CIRCUIT BOARD
CIRCUIT IMPRIMÉ
CIRCUITO IMPRESO

CHAIN/BELT MOTOR
CADENA/CORREA MOTEUR
CHAÎNE/COURROIE MOTOR

SCREW DRIVE MOTOR
IMPULSION DEL
TORNILLO MOTEUR
COMMANDE DE VIS MOTOR

WHITE
BLANC
BLANCO

BLACK
NOIR
NEGRO

GREEN
VERT
VERDE

CHOKES*
BOBINE D'ARRÊT
BOBINA DE CHOKE

WHITE
BLANC
BLANCO

WHITE
BLANC
BLANCO

BLACK
NOIR
NEGRO

BLACK
NOIR
NEGRO

BLACK
NOIR
NEGRO

RED
ROUGE
ROJO

RED
ROUGE
ROJO

BLACK
NOIR
NEGRO

STRIPED WHITE
BLANC RAYÉ
BLANCO RAYADO

STRIPED WHITE
BLANC RAYÉ
BLANCO RAYADO

SAFE-T-BEAM®
SAFE-T-BEAM®
SAFE-T-BEAM®

BLACK
NOIR
NEGRO

(Purchased Separately)
INTELLIGENT WALL CONSOLE
CONSOLE INTELLIGENTE DE MUR
CONSOLA INTELLIGENTE DE LA PARED

WALL CONSOLE
CONSOLE DE MUR
CONSOLA DE LA PARED

MOTION DETECTOR*
DÉTECTEUR DE MOUVEMENT
DETECTOR DE MOVIMIENTO

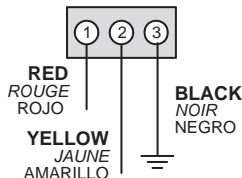

OPTICAL SENSOR*
SONDE OPTIQUE
SENSOR ÓPTICO

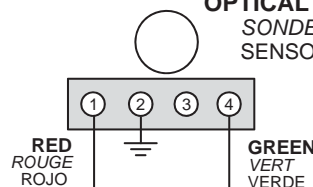

FIG. 6-5

WARNING

AVERTISSEMENT

ADVERTENCIA



ELECTRICAL SHOCK
CHOC ÉLECTRIQUE
CHOQUE ELÉCTRICO

*SOME MODELS DO NOT COME WITH THIS FEATURE
QUELQUES MODÈLES NE VIENNENT PAS AVEC CETTE CONFIGURATION
ALGUNOS MODELOS NO VIENEN CON ESTA CARACTERÍSTICA

**USED ON DC POWERED MODELS ONLY
UTILISÉ SUR DC ACTIONNÉ MODÈLE SEULEMENT
UTILIZADO EN DC ACCIONADO MODELA SOLAMENTE



TRILOG™ 1500 LIMITED WARRANTY

GMI Holdings, Inc. d/b/a The Genie Company ("Seller") warrants to the original purchaser of the below identified residential garage door opener, TriloG™ 1500 (Model 4064 and 4064H) ("Product"), subject to all of the terms and conditions hereof, that the Product and all components thereof will be free from defects in materials and workmanship for the following period(s) of time, measured from the date of purchase:

MOTOR- Seller warrants the motor for the LIFETIME* of the Product.

DRIVE SCREW- Seller warrants the drive screw for the LIFETIME* of the Product.

CORE UNIT PARTS** - Seller warrants all other parts and components of the core unit for a period of FIVE (5) YEARS.

ACCESSORIES - Seller warrants all accessories originally provided with the product for a period of ONE (1) YEAR.

*Lifetime shall mean for as long as the original purchaser owns the home in which the product is originally installed.

**The core unit consists of the powerhead, wired wall control, Safe-T-Beam® system, J-Arm and rail.

Seller's obligation under this warranty is specifically limited to repairing or replacing, at its option, the Product or any part thereof which is determined by Seller to be defective during the applicable warranty period. Any labor charges are excluded and will be the responsibility of the purchaser.

This warranty gives you specific legal rights, and you may also have other rights which vary from state to state. This warranty is made to the original purchaser of the Product only, and is not transferable or assignable. This warranty applies only to Product installed in a residential or other non-commercial application. It does not cover any Product installed in commercial or industrial building applications. This warranty does not apply to any unauthorized or improper installation, alteration or repair of the Product, or to any Product or component which has been damaged or deteriorated due to misuse, abuse, neglect, accident, failure to provide necessary maintenance, normal wear and tear, or acts of God or any other cause beyond the reasonable control of Seller, and does not cover batteries, missing or damaged parts from clearance or open box sales, or repairs or maintenance to door components.

ALL EXPRESS AND IMPLIED WARRANTIES FOR THE PRODUCT, INCLUDING BUT NOT LIMITED TO ANY IMPLIED WARRANTIES OF MERCHANTABILITY AND FITNESS FOR A PARTICULAR PURPOSE, ARE LIMITED IN TIME TO THE APPLICABLE WARRANTY PERIOD REFLECTED ABOVE. NO WARRANTIES, WHETHER EXPRESS OR IMPLIED, WILL APPLY AFTER THE LIMITED WARRANTY PERIOD HAS EXPIRED. Some states do not allow limitations on how long an implied warranty lasts, so the above limitation may not apply to you.

IN NO EVENT SHALL GMI HOLDINGS, INC. OR ITS PARENT OR AFFILIATES BE RESPONSIBLE FOR, OR LIABLE TO ANYONE FOR, SPECIAL, INDIRECT, COLLATERAL, PUNITIVE, INCIDENTAL OR CONSEQUENTIAL DAMAGES, even if Seller has been advised of the possibility of such damages. Such excluded damages include, but are not limited to, loss of use, cost of any substitute product, or other similar indirect financial loss. Some states do not allow the exclusion or limitation of incidental or consequential damages, so the above limitation or exclusion may not apply to you.

Claims under this warranty must be made promptly after discovery and within the applicable warranty period. To obtain warranty service, you must contact Genie® customer service and provide proof of the date and location of purchase and your identity as the original purchaser of the Product. Call Genie® Customer Service toll free at 1-800-354-3643 to speak with a trained representative. Purchaser must allow seller a reasonable opportunity to inspect Product claimed to be defective prior to removal or alteration of its condition. Upon determination by Seller that the Product or any part thereof is defective during the applicable warranty period (which may require purchaser to return the Product to Seller at purchaser's expense), Seller will supply the purchaser with replacement parts or, at its option, a replacement Product (shipping and handling of any replacement part(s) or replacement Product also at purchaser's expense). Seller may use new or reconditioned parts, or a new or reconditioned Product of the same or similar design.

There are no established informal dispute resolution procedures of the type described in the Magnuson-Moss Warranty Act.

PURCHASER: _____

INSTALLATION ADDRESS: _____

DATE PURCHASED: _____ SERIAL NUMBER: _____

OPENER MODEL: _____

REMOTE CONTROL MODEL: _____

DEALER NAME: _____

DEALER ADDRESS: _____

P900-876

Free Manuals Download Website

<http://myh66.com>

<http://usermanuals.us>

<http://www.somanuals.com>

<http://www.4manuals.cc>

<http://www.manual-lib.com>

<http://www.404manual.com>

<http://www.luxmanual.com>

<http://aubethermostatmanual.com>

Golf course search by state

<http://golfingnear.com>

Email search by domain

<http://emailbydomain.com>

Auto manuals search

<http://auto.somanuals.com>

TV manuals search

<http://tv.somanuals.com>