



PRE-PROGRAMMED

REMOTE
INCLUDED
FOR QUICK
& EASY
INSTALL

Serial Number Decal

BELT/CHAIN/SCREW DRIVE

GARAGE DOOR OPENER MODELS:

2562, 2568, 3022, 3024, 3042, 3062, 3064, 4024, 4042, 4062,

4064, 5042, SC1200, CB1000, CB1200

PROGRAMMING, OPERATION & MAINTENANCE MANUAL

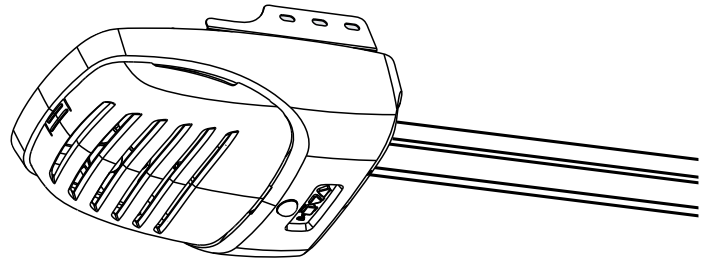

Includes **INTELLICODE**® Remote Control. **Safe-T-Beam**® system must be installed to close the door. For use only with residential One-Piece or Sectional Overhead Garage Doors. **Homelink**® and **Car2U**® compatible



Need help or have questions?
For answers and assistance,
visit www.GenieCompany.com
or call Customer Service at: 1-800-35-GENIE

INSTALLER: LEAVE THIS MANUAL WITH HOMEOWNER
HOMEOWNER: SAVE THIS MANUAL FOR FUTURE REFERENCE

WARNING

To reduce the risk of injury to persons or damage to property, use this opener only with a one-piece or sectional residential door.

AVERTISSEMENT

Por réduire le risque de blessures ou de dommages matériels, utilisez cet ouvre-porte uniquement pour une porte à section résidentielle.

©2015 The Genie® Company, the Genie Logo, Intellicode® and Safe-T-Beam®, are trademarks of GMI Holdings, Inc. d/b/a The Genie® Company. All other trademarks are property of their rightful owners. Consistent with our policy of continuing product improvements, we reserve the right to change product specifications without prior notice or obligations. HomeLink is a registered trademark of Gentex Corporation. Car2U is a registered trademark of Lear Corporation.

38209502755
38267502755

TRANSMITTER COMPLIANCE STATEMENT

Transmitters comply with all United States and Canadian legal requirements as of the date of manufacture. No warranty is made that they comply with all legal requirements of any other jurisdiction. If transmitters are to be used in another country, the importer must determine compliance with any local laws and regulations which may differ from United States and Canadian requirements prior to use.

Los transmisores cumplen con todas las reglamentaciones legales de los Estados Unidos y del Canadá, en la fecha de fabricación. Ninguna garantía se da que cumplan con todas las reglamentaciones legales de ninguna otra jurisdicción. Si los transmisores se van a utilizar en otro país, el importador debe determinar si cumplen con las reglamentaciones y leyes locales que puedan ser diferentes a las reglamentaciones de los Estados Unidos y del Canadá, antes de usar los mismo .

Les émetteurs sont conformes à la réglementation américaine et canadienne à compter de leur date de fabrication. Aucune garantie n'est stipulée indiquant qu'ils sont conformes à toutes les prescriptions juridiques d'autres autorités. Si les émetteurs sont utilisés dans d'autres pays, il incombe à l'importateur d'en déterminer leur conformité aux lois et règles locales pouvant différer de celles des États-Unis et du Canada avant toute utilisation desdits émetteurs.

Sendegeräte entsprechen allen gesetzlichen Bestimmungen in den USA und Kanada zum Zeitpunkt der Herstellung. Wir übernehmen keine Gewährleistung für die Einhaltung aller gesetzlichen Bestimmungen in anderen Ländern. Sollen Sendegeräte in anderen Ländern eingesetzt werden, so muss der Importeur vor dem Gebrauch sicherstellen, dass die Sendegeräte auch solchen lokalen Bestimmungen entsprechen, welche von den Bestimmungen der USA und Kanadas abweichen.

截止于制造日期,传动装置符合美国和加拿大的所有法律要求。不提供传动装置符合任何其他司法地区所有法律要求之担保。如果传动装置需在任何其他国家使用,进口商必须在使用之前确定装置符合与美国和加拿大要求不同之所有地方法规条例。

截止于制造日期,传动装置符合美国和加拿大的所有法律要求。不提供传动装置符合任何其他司法地区所有法律要求之担保。如果传动装置需在任何其他国家使用,进口商必须在使用之前确定装置符合与美国和加拿大要求不同之所有地方法规条例。

截止于制造日期,传动装置符合美国和加拿大的所有法律要求。不提供传动装置符合任何其他司法地区所有法律要求之担保。如果传动装置需在任何其他国家使用,进口商必须在使用之前确定装置符合与美国和加拿大要求不同之所有地方法规条例。

Table of Contents

1	Safety Information	
	Safety Notifications.....	1
	Important Safety Instructions.....	1
	Important Installation Instructions.....	2
2	Features	
	Safety Features	3
	Opener Features	3
	Safe-T-Beam Protection Function.....	3
	Wall Console Features.....	4
3	Programming Information	
	Introduction	5
	Overview of Powerhead Controls.....	5
	Travel Limits.....	
	Closing Garage Door (DOWN Limit)	6
	Opening Garage Door (UP Limit).....	7
	Force Control	8
	Contact Reverse Test.....	8
	Contact Reverse Adjustment.....	8
	Remote Control Programming	9
4	Optional Programming	
	Programming Keypad.....	10-11
	Programming Vehicle Remotes.....	12
	Clearing Memory for Remotes	13
5	Maintenance and Adjustments	
	Important Safety Instructions.....	14
	Regular Maintenance	15
	Remote Battery Replacement.....	15
	Light Bulb Replacement	16
	Adjustment Guides.....	16-17
	Locating Safe-T-Beam® Pairs	18
6	Wiring Diagram	18
7	Troubleshooting	19-20
8	One Piece Door Installation	21
	Warranty	22



If you are a homeowner/end user and need help or have questions: call 800-35-GENIE. Or visit: www.GenieCompany.com Do not return product to the store.

Alternate language manuals available at: www.GenieCompany.com

Idioma alternativo manuales disponibles en: www.GenieCompany.com

Autre langue manuels disponibles à: www.GenieCompany.com

SAVE THESE INSTRUCTIONS

READ AND FOLLOW ALL INSTRUCTIONS

1

Safety Information

OVERVIEW OF POTENTIAL HAZARDS READ THIS SAFETY INFORMATION

Garage doors are large, heavy objects that move with the help of springs under high tension and electric motors. Since moving objects, springs under tension, and electric motors can cause injuries, your safety and the safety of others depend on you reading the information in this manual. If you have questions or do not understand the information presented, call your nearest trained door system technician or visit our website at www.GenieCompany.com.

CONVENTIONS USED IN THESE INSTRUCTIONS

The following safety alert symbol and signal words are used throughout this manual to call attention to and identify different levels of hazards and special instructions.

This is the safety alert symbol. This symbol alerts you to potential hazards that can kill or hurt you and others. All safety messages will follow the safety alert symbol and the word "DANGER", "WARNING", or "CAUTION".



- **DANGER** indicates an imminently hazardous situation which, if NOT avoided, will result in death or serious injury.
- **WARNING** indicates a potentially hazardous situation which, if NOT avoided, could result in death or serious injury.
- **CAUTION** indicates a potentially hazardous situation which, if NOT avoided, may result in injury or property damage.
- The word **NOTE** is used to indicate important steps to be followed or important considerations.

Tous les messages concernant la sécurité seront indiqués après un symbole d'alerte de la sécurité et l'une des mentions suivantes "DANGER", "AVERTISSEMENT" ou "MISE EN GARDE".



- **DANGER** signale une situation dangereuse imminente qui, si elle n'est pas évitée, risque d'entraîner des blessures graves, voire mortelles.
- **AVERTISSEMENT** signale une situation potentiellement dangereuse qui, si elle n'est pas évitée, risque d'entraîner la mort ou des blessures graves.
- **MISE EN GARDE** signale une situation potentiellement dangereuse qui, si elle n'est pas évitée, risque d'entraîner des blessures ou des dommages matériels.
- Le terme **REMARQUE** est utilisé pour signaler les étapes importantes à suivre ou d'importants éléments à prendre en considération.

IMPORTANT SAFETY INSTRUCTIONS

POTENTIAL HAZARD	EFFECT	PREVENTION
MOVING DOOR 	WARNING Could result in Serious Injury or Death	Do Not operate unless the doorway is in sight and free of obstructions. Keep people clear of opening while door is moving. Do Not allow children to play with the door operator. Do Not change operator control to momentary contact unless and external reversing means is installed. Do Not operate a door that jams or one that has a broken spring.
ELECTRICAL SHOCK 	WARNING Could cause Serious Injury or Death	Turn off electrical power before removing operator cover. When replacing the cover, make sure wires are not pinched or near moving parts. Operator must be electrically grounded.
HIGH SPRING TENSION 	WARNING Could cause Serious Injury or Death	Do Not try to remove, repair or adjust springs or anything to which door spring parts are fastened such as wood block, steel brackets, cables or any other structure or like item. Repairs and adjustments must be made by a trained service representative using proper tools and instructions.

IMPORTANTES CONSIGNES DE SÉCURITÉ

DANGER POTENTIEL	EFFET	PRÉVENTION
PORTE EN MOUVEMENT 	AVERTISSEMENT Pourrait entraîner des blessures graves voire la mort	Utiliser uniquement si la porte est en vue et libre de tout obstacle. Ne laisser personne se tenir dans l'ouverture de la porte pendant qu'elle est en mouvement. Ne pas permettre aux enfants de jouer avec l'opérateur de la porte. Ne pas modifier la commande de l'opérateur à contact momentané à moins qu'un moyen d'inversion externe soit installé. Ne pas faire fonctionner une porte qui bloque ou dont le ressort est cassé.
CHOC ÉLECTRIQUE 	AVERTISSEMENT Pourrait entraîner des blessures graves voire la mort	Couper le courant avant d'enlever le couvercle de l'opérateur. Lorsque le couvercle doit être remplacé, s'assurer que les fils ne sont ni coincés ni près des pièces mobiles. L'opérateur doit être correctement mis à la terre.
TENSION ÉLEVÉE RESSORT 	AVERTISSEMENT Pourrait entraîner des blessures graves voire la mort	Ne pas essayer d'enlever, réparer ni ajuster les ressorts ou toute autre pièce à laquelle le ressort de la porte est attaché, y compris blocs de bois, supports en acier, câbles ou autres articles semblables. Les réparations et les réglages doivent être effectués par technicien qualifié qui se sert d'outils appropriés et qui respecte les instructions.

1 Safety Information

IMPORTANT INSTALLATION INSTRUCTIONS

WARNING

TO REDUCE THE RISK OF SEVERE INJURY OR DEATH

READ AND FOLLOW ALL SAFETY, INSTALLATION AND OPERATION INSTRUCTIONS. If you have any questions or do not understand an instruction, call The Genie Company.

- **DO NOT** install operator on an improperly balanced door. An improperly balanced door could cause severe injury. Repairs and adjustments to cables, spring assembly and other hardware must be made by a trained service person using proper tools and instructions.
- Remove all ropes, and disable all locks connected to the door before installing operator.
- Where possible, install the door opener 7 feet or more above the floor. For products having an emergency release, mount the emergency release within reach, but at least 6 feet above the floor and avoiding contact with vehicles to avoid accidental release.
- **DO NOT** connect the operator to the source of power until instructed to do so.
- Locate the wall control button: A) Within sight of door. B) At a minimum height of 5 feet, so small children cannot reach it. C) Away from all moving parts of the door.
- Install the entrapment WARNING label next to the wall button or console, in a prominent location. Install the emergency release handle on the emergency release cord.
- The operator must reverse when the door contacts a 1-1/2 inch high object on the floor at the center of the doorway. This is about the size of a 2" x 4" board laid flat.

IMPORTANTES INSTRUCTIONS D'INSTALLATION

AVERTISSEMENT

POUR RÉDUIRE LES RISQUES DE BLESSURES GRAVES VOIRE MORTELLES

LIRE ET SUIVRE ATTENTIVEMENT TOUTES LES INSTRUCTIONS D'INSTALLATION ET DE FONCTIONNEMENT AINSI QUE TOUTES LES CONSIGNES DE SÉCURITÉ. Si vous avez des questions ou si vous ne comprenez pas une instruction, veuillez contacter directement The Genie Company.

- **NE PAS** installer l'opérateur sur une porte mal équilibrée. Celle-ci pourrait entraîner de graves blessures. Les réparations et les réglages des câbles, ensembles de ressort ou tout autre article de quincaillerie doivent être effectués par un professionnel qui se sert d'outils appropriés et qui respecte les instructions.
- Enlever toutes les cordes et désactiver toutes les verrous de la porte avant l'installer l'opérateur.
- Dans la mesure du possible, installer l'ouvre-porte à 2,1 m ou plus au-dessus du sol. Pour les produits dotés d'un cordon de déclenchement d'urgence, installer le déclenchement d'urgence mais au moins à 1,8 m au-dessus du sol en évitant tout contact avec les véhicules pour éviter qu'ils ne soient déclenchés accidentellement.
- NE PAS connecter l'opérateur à la source d'alimentation tant que l'instruction n'est pas donnée.
- Repérer la console murale: A) En vue de la porte. B) À une hauteur minimale de 1,5 m afin que les jeunes enfants ne puissent pas l'atteindre. C) Loin de toutes pièces mobiles de la porte du garage.
- Placer l'étiquette d'AVERTISSEMENT en cas de coinçage à proximité du bouton mural ou de la console de manière à ce qu'elle soit bien en évidence. Installer la poignée du cordon de déclenchement d'urgence.
- L'opérateur doit s'inverser lorsque la porte entre en contact avec un objet d'une hauteur de 3,8 cm placé sur le sol, au centre de l'ouverture de la porte. Ceci équivaut environ à une planche de 5 x 10 cm posée à plat sur le sol.

WARNING

Operator is equipped with grounded electrical plug for your protection, and **only fits grounded electrical outlets. DO NOT** alter plug in any way! **If your have no grounded outlets, have one installed by a licensed electrician.**

Operator must be properly grounded to prevent personal injury and equipment damage. NEVER USE AN EXTENSION CORD! Check local building codes for any requirement that you must have a permanent hard-wired connection. Permanent hard-wired connections must be performed by a licensed electrician using proper tools and instructions.

AVERTISSEMENT

L'opérateur, qui est équipé d'une prise électrique mise à la terre pour votre protection est compatible uniquement avec des prises électriques mises à la terre. NE PAS modifier la fiche d'une quelconque manière. Si vous n'avez pas de prises mises à la terre, faites-en installer par un électricien agréé. L'opérateur doit être correctement mis à la terre pour éviter les blessures corporelles et des dommages matériels. NE JAMAIS UTILISER DE RALLONGE! Vérifiez les codes locaux des bâtiments pour connexions câblées permanentes. Les connexions câblées permanentes doivent être effectuées par un électricien agréé qui se servira d'outils appropriés et respectera les consignes.

Begin here **ONLY AFTER** completing assembly and installation of the opener. Review the **Assembly and Installation Poster** to ensure all steps have been performed. Visit www.GenieCompany.com to download a printable file.

SAFETY FEATURES

Safe-T-Beam® (STB) Non-Contact Reversing System

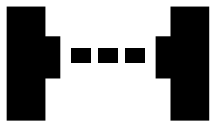

Puts an invisible beam across the door opening. The door stops and reverses to the full open position if anything passes through the beam. LED indicator lights on the powerhead and on the STBs provide self-diagnostics if an operational problems exists.

Safe-T-Reverse® Contact Reversing System

Automatically stops and reverses a closing door within two seconds of contact with an object.

Automatic ForceGuard™ Control

Automatically sets the force required to fully open and close the door for maximum safety.

Door Detect™ Monitoring System

Monitors the Safe-T-Beam® system to ensure proper functionality and will automatically stop and reverse a closing door if a problem is detected.

Manual Emergency Release



Manually releases door from door opener. Used during a power failure or other emergency to allow manual opening and closing of door.



SmartSet® Electronic Programming

Easily adjust the programming to set limits and program new remotes.

Automatic Lighting System

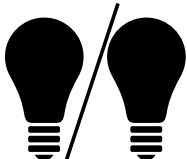

Single or Dual Bulb lighting system supplies light for safer evening exits and entries. Turn ON when door is activated and automatically turns OFF 4 minutes later.



Integrated Motion Detection (Optional on some models)

Lights automatically turn ON when motion is detected for much safer movement through the garage. Lights will turn OFF after four minutes of no motion.

OPENER FEATURES

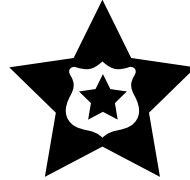

Intellicode®

An encryption system that enhances the security of the door opener by continuously changing the access code each time the remote is used. The door opener responds to each new code only once. An access code copied from a working system and tried again, will not control the door opener.



Wall Console

Operates door opener from inside garage. The wall console has an indicator light with: Open/Close, Sure-lock™, and independent light control buttons.



Home Link® and Car2U® compatible. See page 12 in this manual, refer to the motor vehicle manual or visit www.GenieCompany.com for instructions.



Pre-Programmed Remote Control

For ease and speed of installation, the remote included with this opener comes from the factory, pre-programmed. No additional steps are required to activate the door using the remote.



NOTE: Use this manual **ONLY** after completing assembly and installation of the opener.

Review the **Assembly and Installation Instructions poster**. Check that all steps have been completed.

Safe-T-Beam® (STB) FUNCTION

1. The Safe-T-Beam® has no effect on the door during an opening cycle.
2. If the Safe-T-Beam® detects an obstruction when trying to close the door, it will not allow the door to close.
3. When the garage door is closing, if Safe-T-Beam® is interrupted by a person or obstacle, the garage door will stop its downward travel and reverse automatically to its fully opened position.
4. If the Safe-T-Beam® System fails, loses power, or is installed improperly, press and hold the wall console "open/close" button until the door reaches its fully closed position. If you release the "open/close" button on the wall console during the closing movement, the door will reverse automatically to its fully-opened position.

Wall Control Features

One of the following wall controls will be included.

NOTE: Wall consoles from other manufacturers may not work with this new opener. Use only the wall control provided with this unit. See warning.

SERIES II WALL CONSOLES

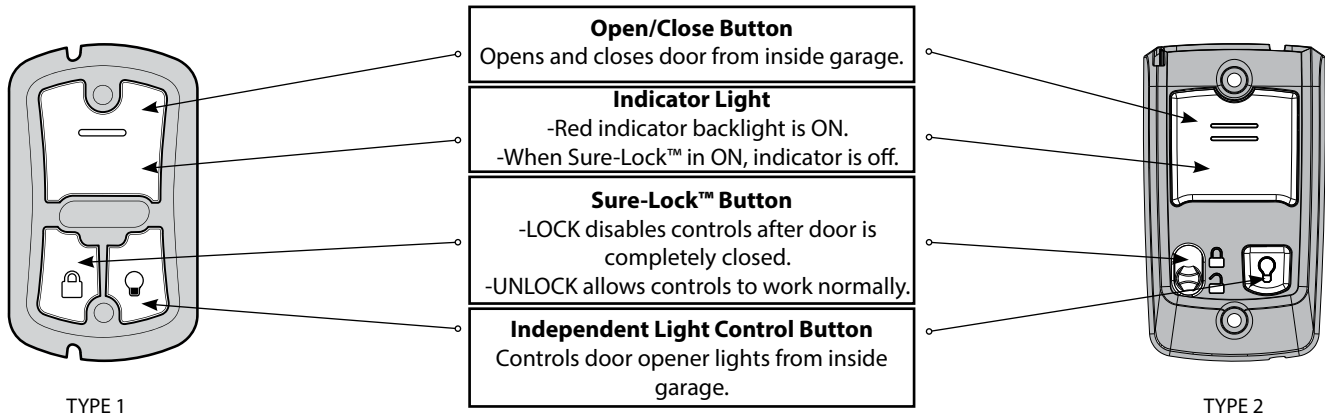

TYPE 1 FEATURES

Indicator Light

Large white button will display Red when wall console is properly wired and Sure-Lock™ is OFF. When Sure-Lock™ is ON, this light is off.

Open/Close Button

Use this button to open or close garage door. When Sure-Lock™ is ON the Open/Close button will CLOSE the door only.

NOTE: Constant button pressure in the CLOSE direction will override STB fault in the powerhead and close door.

Independent Light Control Button

Use this button to turn the powerhead lights ON. Powerhead lighting will remain ON until this button is pressed again or a door action has been completed.

Sure-Lock™ Button

When Sure-Lock™ is ON, and the door is closed, the powerhead cannot be activated by the wall console or a remote.

- Press and release to activate Sure-Lock™ (red light goes off).
- Press and release to turn Sure-Lock™ OFF (red light goes on).

TYPE 2 FEATURES

Indicator Light

Large white button will display Red when wall console is properly wired and Sure-Lock™ is OFF. When Sure-Lock™ is ON, this light is off.

Open/Close Button

Use this button to open or close garage door. When Sure-Lock™ is ON the Open/Close button will CLOSE the door only.

NOTE: Constant button pressure in the CLOSE direction will override STB fault in the powerhead and close door.

Independent Light Control Button

Use this button to turn the powerhead lights ON. Powerhead lighting will remain ON until this button is pressed again or a door action has been completed.

Sure-Lock™ Button

When Sure-Lock™ is ON, and the door is closed, the powerhead cannot be activated by the wall console or a remote.

- Slide switch up to activate Sure-Lock™ (red light goes off).
- Slide switch down to turn Sure-Lock™ OFF (red light goes on).

WALL BUTTON

This is a lighted wall button. Press once to move the door.

If the button is not lighted, check:

- White wire connected to terminal "W"
- Striped wire connected to terminal "B"

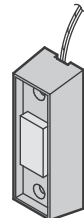

⚠ WARNING

Use of any other wall control can cause unexpected operation of the door and loss of lighting feature. Locate wall console within sight of door but far enough from door to prevent contacting it while operating the console. Control must be at least 5 feet above the floor to prevent small children from operating it.

⚠ AVERTISSEMENT

l'utilisation d'une autre commande murale pourrait des résultats in attendus de la porte ainsi que le dysfonctionnement de l'éclairage. Localisez la console murale en vue de la porte et suffisamment loin de la porte pour éviter tout contact pendant l'utilisation de la console. La commande doit être à une hauteur minimale de 1,5 m au-dessus du sol afin que les jeunes enfants ne puissent pas l'attendre.

Programming Overview

NOTE: Before programming the operator, check to make sure there are no objects in the garage door opening.

INTRODUCTION

Now that the garage door opener is installed, follow the steps in this manual to program the opener so that the door opens and closes properly and all remote devices operate correctly. The following steps are a guide to setting opener so it functions properly.

The following steps list the order of programming the opener's functional settings for use.

1. "TRAVEL LIMITS"
2. "FORCE and SPEED CONTROLS"
3. "REMOTE PROGRAMMING"

Term Definitions:

Travel Limits Programmable setting to adjust how far door travels up or down.

Force Control refers to how much power is needed to move (open/close) a particular door and does NOT require programming.

Speed Control refers to how fast or slow the opener opens and closes the door. This is factory set and does NOT require programming. NOT available on all models.

Remote Programming synchronizes remote devices (remote, wall console, and keypad) with the powerhead.

OVERVIEW OF POWERHEAD CONTROLS

This section describes the programming functions of the opener. Use the following information to understand the buttons, LED indicators and products used to program functions.

Powerhead: There are 3 programming buttons and 2 LED lights on the powerhead. Each of the buttons are used to enter and complete the setup programming. The LED lights indicate status or a function change by illuminating ON, OFF, or ON FLASHING in one of three different colors: blue, red or purple.

There are 4 programs:

1. Door Travel Limits.
 - This program is used to set how far the door travels up and down.
2. Remote Programs (default menu)—only required for added remote control transmitters.
 - Describes how to program remotes to sync with additional remote control devices, wall consoles, keypads and the powerhead.
3. Force Setting Program.
 - This program controls the force applied during the closing and opening of the door. They are factory set and will rarely require adjustment only under certain circumstances.
4. Door Speed Program.
 - This program does not require manually initiated changes.

NOTE: The 3 programming buttons are for programming ONLY. These buttons should NOT be used to operate the opener once the Required Programming section has been successfully completed.

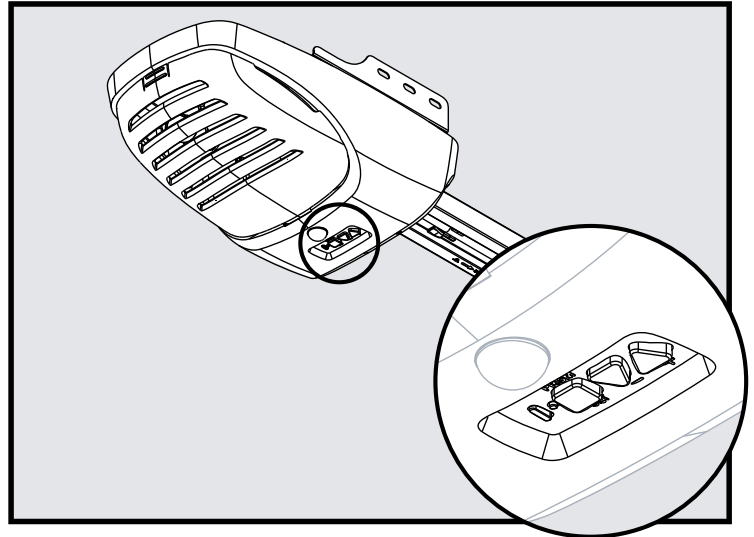

ORIENTATION

Standing under the opener's powerhead – facing the door – looking up – this is the view you will see of the programming buttons and LEDs.

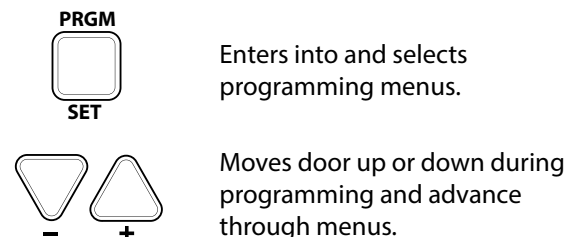
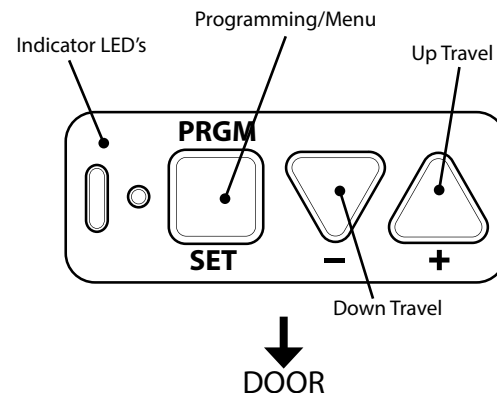

Enters into and selects programming menus.

Moves door up or down during programming and advance through menus.

NOTE: While setting limits, the powerhead has a 30 second time-out period when none of the three programming buttons have been selected. If you see two solid red flashing LEDs or if the LEDs flash red three times and then go OFF, you have run out of time and must go back to the beginning of the travel limit setting step.

- Just remember—the pointed end of the button (like an arrowhead) points in the direction the carriage will move when that button is pushed.

3

Programming Information

TRAVEL LIMITS

⚠ WARNING

- Make sure doorway is in full view and clear of obstacles and people to avoid injury or property damage.
- DO NOT operate this unit from the wall control before LIMITS are set. Severe damage to the opener could occur.
- The carriage MUST be engaged BEFORE setting limits. See installation poster (if provided) or call Customer Service at 1-800-35-GENIE or visit www.GenieCompany.com.

NOTE: If carriage has NOT been engaged to carriage, do so now.

Before setting limits: confirm wall console red indicator back light is ON. If not illuminated, See page 19 for troubleshooting.

Check STB LED's: Confirm both LED's are illuminated solid. If not illuminated solid, see page 18 for troubleshooting.

Closing Garage Door (Down Limit)

NOTE: Beginning with garage door in mid travel is recommended but not necessary.

1. Lift door by hand until carriage engages the shuttle on screwdrive or the bullet on the chain/belt.

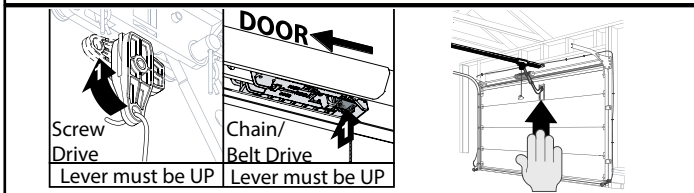

READ AND UNDERSTAND STEPS 2-5 BEFORE PROCEEDING

2. Press and hold the down arrow button (-) for two seconds or until the long LED comes on blue. (The round LED stays off.)

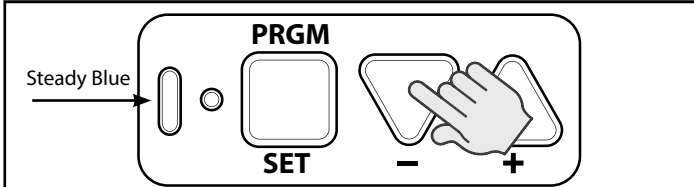

3. Release down arrow button (-) and the long LED will begin flashing blue. (Round LED still off.)

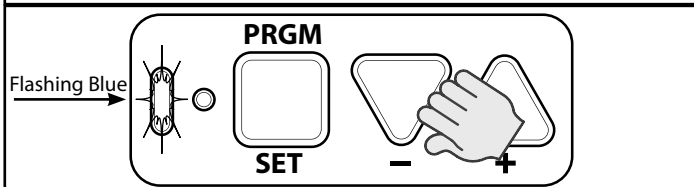

⚠ AVERTISSEMENT

- S'assurer que le passage de la porte est visible et dégagé, à savoir sans obstacles ni personne afin d'éviter toute blessure potentielle ou dommage matériel.
- NE PAS utiliser cette unité avec la console murale avant d'avoir réglé les LIMITES. L'ouvre-porte pourrait subir de sérieux dommages.
- La tendeur DOIT être engagée dans le chariot AVANT de régler les limites. Voir le poster d'installation (si fourni) ou appelez le service clientèle au 1-800-35-GENIE ou visitez le site www.GenieCompany.com.
- NE PAS fixer de limites en mode batterie de secours. L'alimentation CA DOIT être branchée sur l'ouvre-porte, pendant le réglage des limites, pour assurer un bon fonctionnement.

4. Press and hold the down arrow button (-) to begin closing the garage door. When the garage door is fully closed, release the down button (-). If it has gone too far press and release the up button (+) to move the door up slightly. The door can be moved up or down with the arrow buttons. The door should rest tightly on the floor.

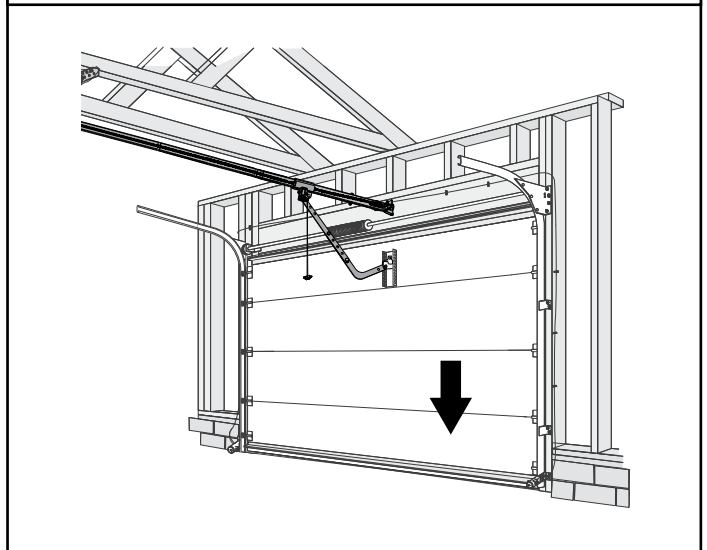

5. Press and release the program/set button—both LEDs flash blue and then go off. **The DOWN (CLOSED) TRAVEL LIMIT IS NOW PROGRAMMED.**

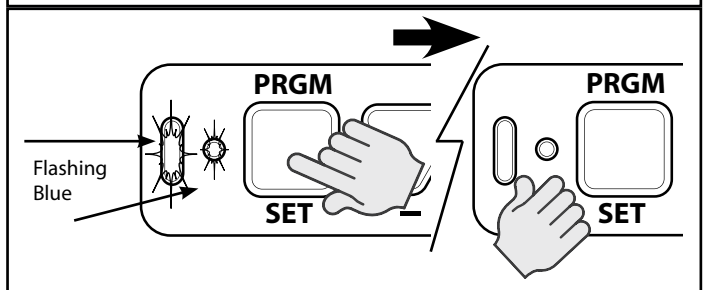

Opening Garage Door (Up Limit)

NOTE: Beginning with garage door closed is recommended but not necessary.

READ AND UNDERSTAND STEPS 6-9 BEFORE PROCEEDING

6. Press and hold the UP arrow button (+) for two seconds or until the long LED comes on blue. (The round LED stays off.)

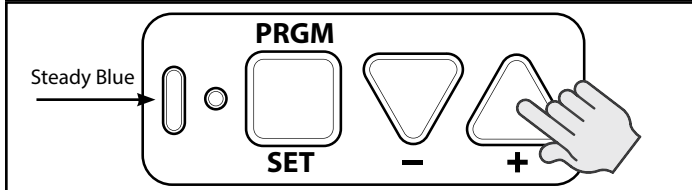

7. Release UP arrow button (+) and the round LED will begin flashing blue. (the long LED will go off.)

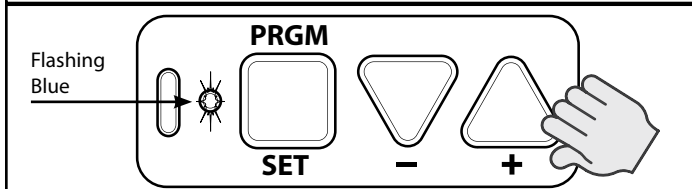

8. Press and hold the up arrow button (+) to begin opening the garage door. When the garage door is fully opened, release the up button (+). If it has gone too far press and release the down button (-) to move the door down slightly. The door can be moved up or down with the arrow buttons. Stop the carriage short of the opener powerhead. It is important for the red cord to be clear of the powerhead to allow for manual door operation.

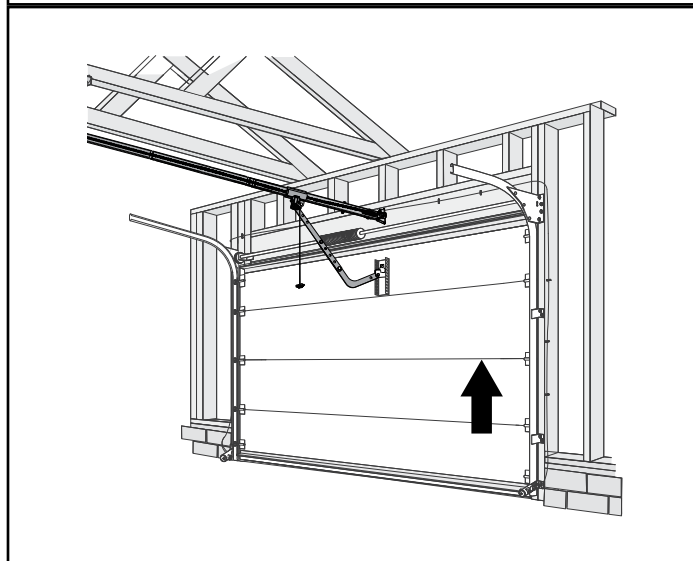

9. Press and release the program/set button—both LEDs flash blue and then go off.
The UP (OPEN) TRAVEL LIMIT IS NOW PROGRAMMED.

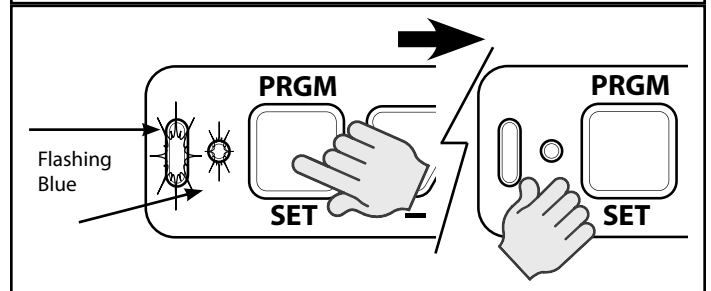

3

Wall Control Operation

Force Control

The force controls are automatically set when the wall control is used for the first time with garage door opener. The door **MUST** complete one full cycle, from full open to full close and then, full close to full open, before the settings are automatically recorded.

- 10.** Press and release the wall console Open/Close button and allow the garage door to travel and stop at the down (closed) limit.

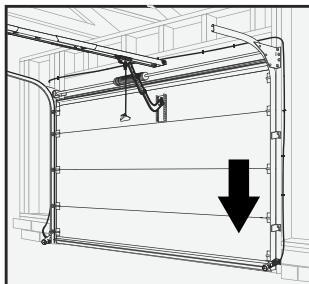
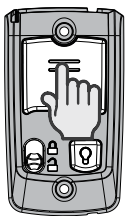

- 11.** Press and release the wall console Open/Close button and allow your garage door to travel and stop at the up (open) limit.

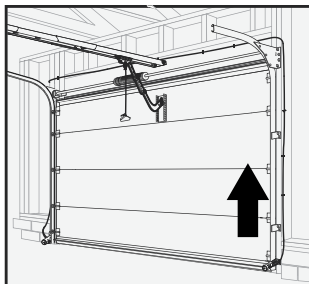
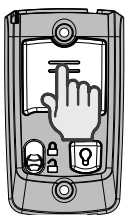

NOTE: Force controls **DO NOT** require programming. Force limits are factory set and rarely require adjustments. Making adjustments to these settings is covered in the "Maintenance and Adjustments" Section of this Manual (pages 14-18). **FORCE CONTROL IS NOW SET.**

⚠ WARNING

TO AVOID INJURY OR DAMAGE

- **NEVER** adjust the force settings to adjust for damage, including an unbalanced door, binding door track or broken spring.
- Perform a CONTACT REVERSE TEST monthly.

⚠ AVERTISSEMENT

Pour éviter les blessures ou des dommages

- **NE JAMAIS** régler la force pour compenser des dommages, y compris une porte mal équilibrée, un rail de porte coincant ou des ressorts cassés.
- Tous les mois, EFFECTUEZ LE TEST D'INVERSION AU CONTACT.

Contact Reverse Test

NOTE: The limit and Force settings **MUST BE COMPLETED** before performing the Contact Reverse Test.

- 12.** With the garage door open, lay a 2" x 4" board flat on the floor at the center of the door opening.

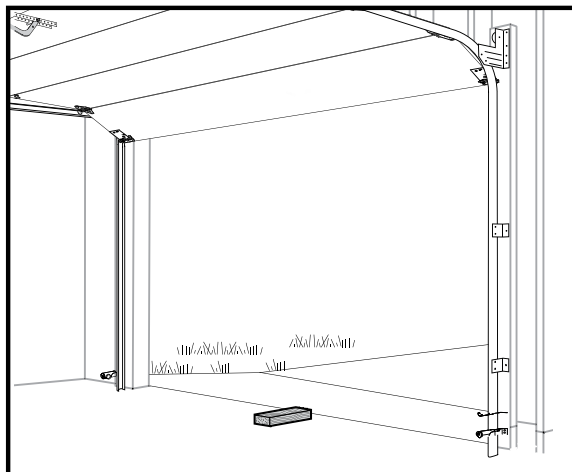

- 13.** Close the garage door using the Open/Close button on the wall control.

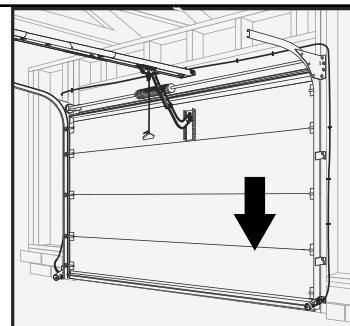
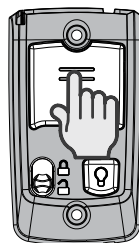

When the door contacts the board, it should stop and reverse direction within 2 seconds to the fully open position. Long LED light on the powerhead will begin to flash RED with the reversal of the door. Remove the 2" x 4" board after a successful contact reversal test. The next cycle will clear the flashing red LEDs.

Contact Reverse Adjustment

If the door stops before contacting the board or if it does not reverse direction to fully open after contact with the board, it may be due to an improperly set DOWN limit. Verify settings by:

1. Repeat the "Down Travel Limit" section (page 6) to make certain the door is closing tight against the floor.
2. Repeat the "Force Control" section on the left to set force limits.
3. Repeat the "Contact Reverse Test" above.

Repeat this process as needed until the door passes the Contact Reverse Test. For further help, refer to the "Maintenance and Adjustment" section/Regular Maintenance. (Pages 14-18).

Remote Control Programming

REMOTES

NOTE: THE REMOTE CONTROLS INCLUDED WITH THIS OPENER, HAVE BEEN PRE-PROGRAMMED AT THE FACTORY FOR YOUR CONVENIENCE.

NOTE: The following instructions are for remote control transmitters purchased separately in addition to those provided with this opener, but can also be used if any remote(s) may require re-programming.

NOTE: Each programming step has a 30 second time limit for completion after the function is initiated. After 30 seconds, two LED's will illuminate RED indicating time has expired and the step must be re-started. Restart the step as many times as necessary to complete the programming.

NOTE: Do NOT hold Remote too close to the Powerhead when programming Remote buttons.

NOTE: Each button on each Remote must be programmed separately, following these steps.

1. Remove the battery's protective film from the remote by pulling it straight out.



2. Press and hold the program button on the opener for two seconds until the round LED turns blue, then release. The long purple LED will flash.

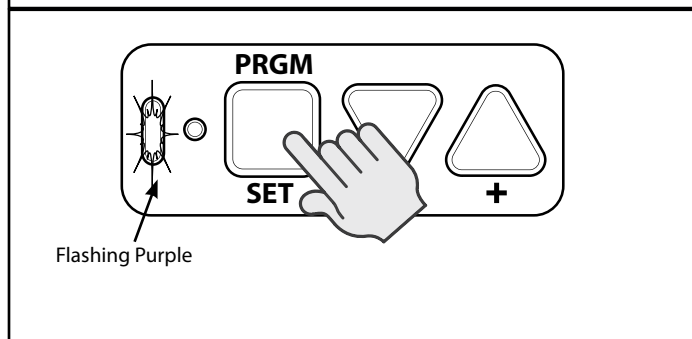

3. Slowly press and release the remote button two times. The opener LEDs will flash and go off, indicating it has been successfully programmed to the remote.

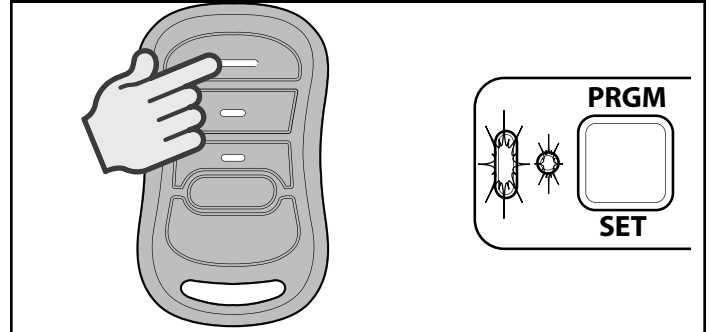

NOTE: While programming remote buttons, stand at least 5 feet away from the powerhead. This ensures you have proper communication between the remote and the powerhead.

4. Press and release the same button a third time and door will open or close.

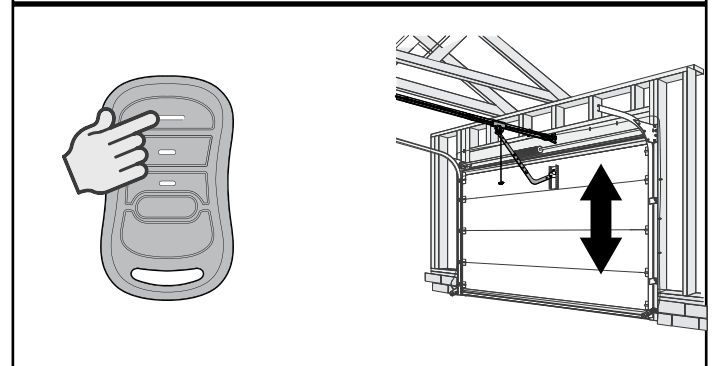

To program the same remote for other garage door openers, repeat the steps above using one of the other remaining remote buttons.

REPEAT STEPS 1 TO 4 FOR EACH OPENER AND REMOTE

NOTE: It is possible to press the remote button too quickly or lightly. If the LEDs do not go off, press the remote button several more times to achieve confirmation.

BASIC PROGRAMMING IS COMPLETE AND YOUR GARAGE DOOR OPENER IS READY TO USE.

FCC and IC Certified

This device complies with FCC Part 15 and Industry Canada license exempt RSS standard(s). Operation is subject to the following two conditions: (1) this device may not cause interference, and (2) this device must accept any interference, including interference that may cause undesired operation of the device. This equipment generates, uses and can radiate radio frequency energy and, if not installed and used in accordance with the instructions, may cause harmful interference to radio communications. However, there is no guarantee that interference will not occur in a particular situation. If this equipment does cause harmful interference to radio or television reception, which may be determined by turning equipment OFF and ON, the user is encouraged to try and correct the interference by one or more of the following measures: (a) Re-orient or relocate the receiver antenna, (b) Increase the separation between the opener and receiver, (c) Connect the opener into an outlet on a circuit different from that which the receiver is connected, and (d) Consult your local dealer. Any modification or changes to this equipment which is not expressly approved by the manufacturer could void the user's authority to operate the equipment. This device complies with the Health Canada's Safety Code. The installer of this device should ensure that the RF radiation is not emitted in excess of the Health Canada's requirement. Information can be acquired at: <http://www.hc-sc.gc.ca/ewh-semt/radiation/cons/wifi/index-eng.php>

Programming Wireless Keypad

(Optional on some models)

Tip: Program Keypad before mounting.

Keypad Overview:

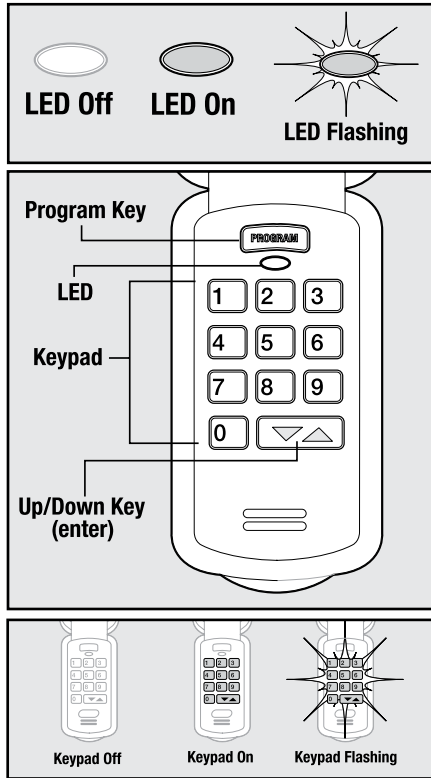

OPEN BATTERY COVER AND PULL PAPER TAB TO ALLOW OPERATION

Setting the PIN for the First Time:

1. Press in order the numbers **3 - 5 - 7**
2. Press the **PROGRAM** key
3. Type a new PIN (3-8 digits)
4. Press the **PROGRAM** key again

The keypad is ready to program to an opener.

For use on a Single Door, continue to **Synchronizing Keypad to Door**.

NOTE: If the keypad lights do not flash and go OFF after setting PIN, clear the keypad and repeat Step 1; see page 11 for Resetting a PIN.

Locate the Opener's Programming Buttons and LED:

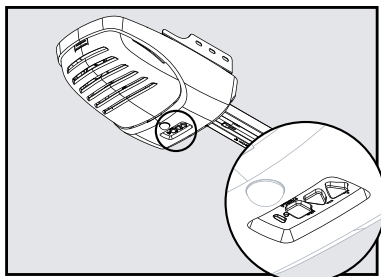

Synchronizing Keypad to Door

1. Press **PROGRAM SET** button two seconds until the round LED turns blue, then release. The long purple LED will blink.

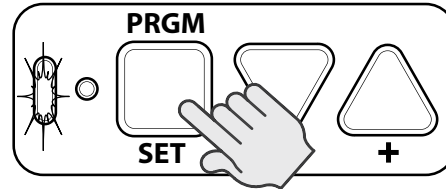

2. Key in the new PIN on the keypad.
3. Press Up/Down key and opener LEDs will stay on steady.
4. Press Up/Down key again and opener LEDs turn off.
5. Press Up/Down key a third time and opener runs.

The process of programming ONE keypad to ONE opener is complete.

Multiple Door Section:

1. Key in the new PIN on the keypad (3-8 digits).
2. Press the **PROGRAM** key two times.
3. Enter how many total doors the keypad will control (press 2 or 3 accordingly).
4. Press the **PROGRAM** key.
The keypad is now programmed to receive multiple opener signals.
5. Locate the opener's programming buttons and LED.
Press **PROGRAM SET** button two seconds until the round LED turns blue; then release. The long purple LED will flash.
6. Type the new PIN (3-8 digits).
7. Press the Up/Down key one time.
8. Assign a number to the door that the keypad will operate by pressing 1-2 or 3.
9. Press that door number a second time.
10. Press that same door number a third time and the door will operate.

Wait 30 seconds for the keypad to go dark and then start with step 5 for the additional door/keypad combination as needed.

To add another opener to a keypad that is already programmed to an opener, follow all the steps in the "Multiple Door Section".

Please note at Step 8, that the keypad assumes the original opener programmed to the keypad is opener #1.

Keypads can accept up to three openers.

Programming Wireless Keypad

(Continued)

Door Operation with Wireless Keypad:

To open and close a single door with the Keyless Entry Pad, enter the PIN number and press Up/Down Key (enter).

For multiple doors enter the PIN number, press the UP/Down Key once and enter the door number (1,2 or 3).

NOTE: *The Keyless Entry Pad will stay active for 30 seconds and will stop or start the door with each touch of any button on the keypad.*

Changing an Existing PIN:

1. Enter the current PIN
2. Press the Program key one time
3. Key in the new PIN (3-8 digits)
4. Press the Program key one time

NOTE: *Unlike "Resetting PIN," there is no need to reprogram your opener after changing the PIN.*

Resetting a PIN:

Press and hold both the **PROGRAM** key and the Up/Down key for about five seconds.

The LED's will slowly blink and then go out. When the LED stops blinking, the old programming has been successfully erased.

To create a new PIN, start with "Setting the PIN for the First Time"

Mounting Keypad

The keypad **MUST** be mounted within sight of the garage door(s) at least five feet above the floor and clear of any moving door part.

1. Remove battery cover and batteries.
2. Drill 3/32" pilot hole for the top mounting screw (included).

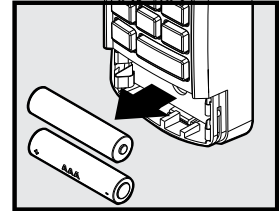
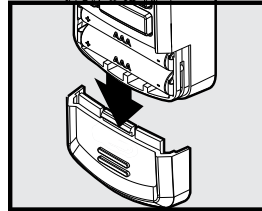

3. Install a screw into the pilot hole, leaving a 1/8" gap between the screw head and wall.
4. Hook the slotted mount, on back of keypad, over the screw.

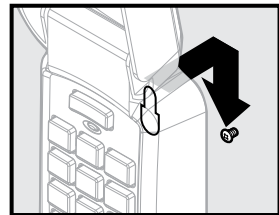
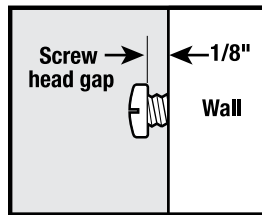

5. Mark and drill a pilot hole for the bottom screw (included) and secure keypad to wall (**DO NOT** overtighten).

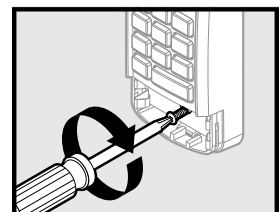
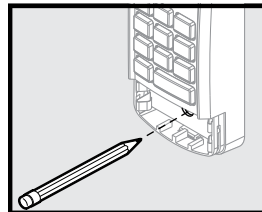

6. Reinstall batteries and cover.

Programming Vehicle Remotes

Programming HomeLink® System

Step 1 Clear HomeLink

Clear HomeLink by pressing and holding down the first and third buttons until the indicator on the HomeLink blinks slow and then fast for 20 seconds; then release both buttons.

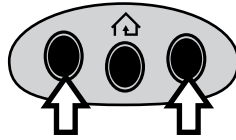

NOTE: Clearing the HomeLink will remove all previously programmed garage door openers.

Step 2 Train HomeLink to the Genie Remote

Choose the button on the HomeLink that will be used to open the door.

NOTE: Hold the Genie Remote two inches from the HomeLink button.

Hold down the Genie remote button. While holding, press and hold the chosen HomeLink button.

Hold down both buttons until the indicator on the HomeLink blinks slow then fast. Once it blinks, release both buttons.

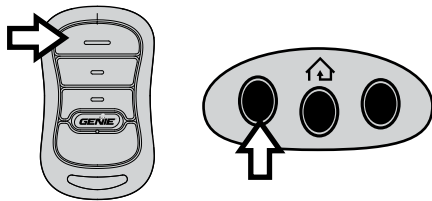

Step 3 Program HomeLink to the Genie Opener

A. Press and hold the **PROGRAM** button on the opener until the round blue LED is ON. Release the button. The long purple LED will begin flashing.

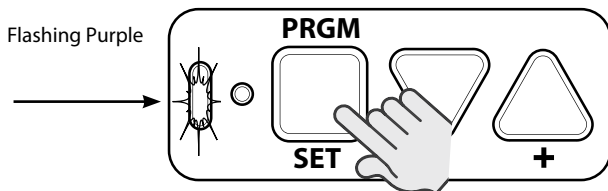

B. Press the chosen HomeLink button for two seconds and release. Press that same button again for two seconds and release. The long LED will flash blue and then turn off.

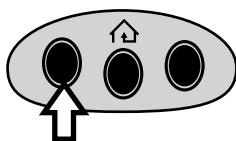

C. Press the HomeLink button a few more times until door moves.

NOTE: For additional instructions, see the motor vehicle manual, www.homelink.com or visit www.GenieCompany.com

Programming Car2U® System

Step 1 Clear Car2U to default settings

The default setting for the Car2U system is:

- Button 1 = Genie® Manufactured Openers
- Button 2 = LiftMaster® Manufactured Openers
- Button 3 = Wayne Dalton® Manufactured Openers

- A. Press and hold buttons 1 and 3 for 20 seconds or until all three LEDs begin to flash.
- B. Release both buttons. The Car2U system is now set to the Factory Default settings

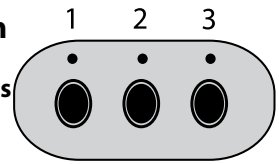

NOTE: Clearing the Car2U remote will remove all previously programmed garage door openers.

Step 2 Program Car2U to the Genie Opener

- A. Press and hold the **PROGRAM** button on the opener until the round blue LED is ON—release the button. The long purple LED will begin flashing.

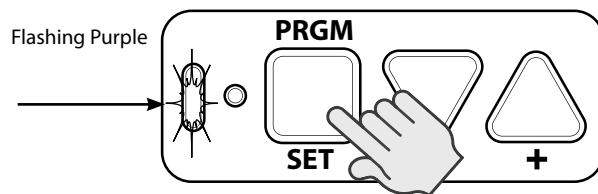

- B. Press the designated Genie Car2U button for two seconds and release. Press that same button again for two seconds and release. The long LED will flash blue and then turn off.

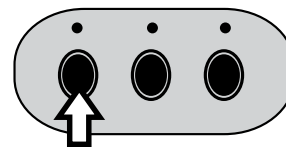

- C. Press the Car2U button a few times more until door moves.

Step 3 Changing Factory Default Button for a Genie Opener

- A. Press and hold buttons 1 & 3 for **ONE SECOND** and release—all three LEDs will light solid red.
- B. Press and hold the button (2 or 3) to change it to Genie—the corresponding LED will flash. While continuing to hold that button, press and release button 1. Press and release button 1 again.
- C. Release the button being held in step B and wait for the LED to stop flashing. This button is now set for Genie. Repeat Step 2 for second Genie Opener.

NOTE: For additional instructions see the motor vehicle manual, learcar2u.com or visit www.GenieCompany.com

4

Clearing Remotes

CLEARING MEMORY OF REMOTES

NOTE: Clearing memory of remotes from the powerhead will clear ALL programmed remotes and wireless keypads. The opener will no longer recognize any signal from any remote device, including a missing remote device.

All remaining (or recovered) remotes and wireless keypads MUST be reprogrammed as shown in pages 9,10,12.

NOTE: The garage door opener will operate normally using the wall console.

1. Press the PROGRAM/SET button on the powerhead and hold for two seconds or until the round LED turns blue.

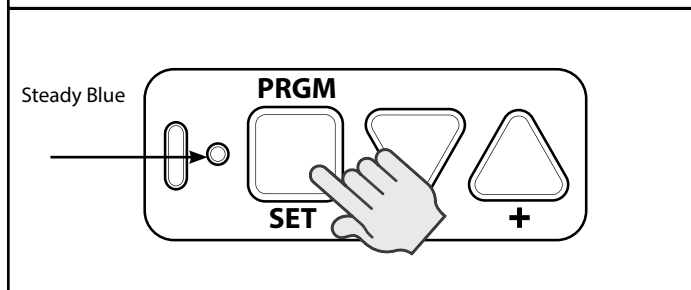

2. Release the PROGRAM/SET button—the round LED goes off and the long LED flashes purple.

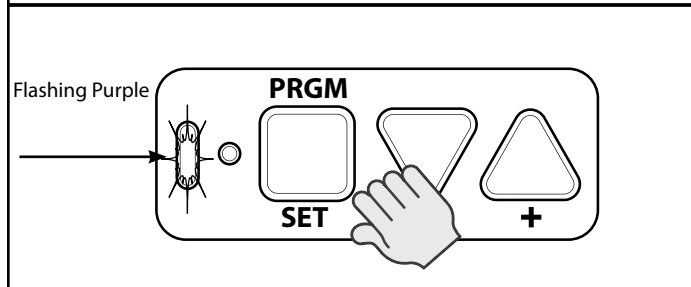

3. Press and hold the UP (+) and DOWN (-) button at the same time, until both LEDs flash blue and go off.

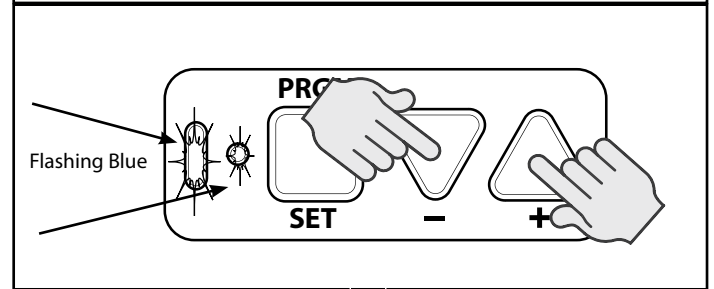

4. To verify that the memory is cleared, press the remote key that was previously programmed to the opener.

If the memory has been cleared the opener will NOT run.

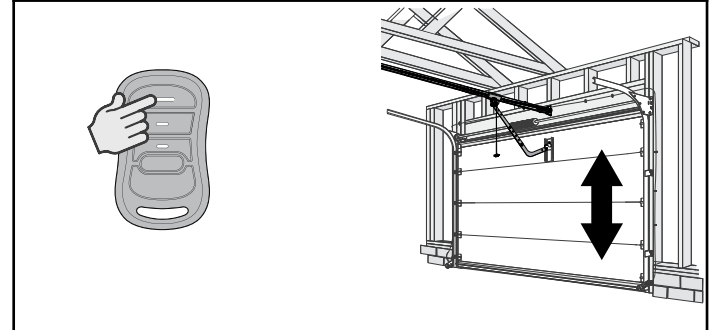

If the remote is successfully cleared, the round powerhead LED will flash blue when the remote button is pressed and the opener will not operate.

IMPORTANT SAFETY INSTRUCTIONS

⚠ WARNING

TO REDUCE THE RISK OF SEVERE INJURY OR DEATH, READ AND FOLLOW ALL INSTRUCTIONS.

- NEVER** let children operate or play with the door controls.
- Keep remote away from children.
- ALWAYS** keep the moving door in sight and away from people and objects until door is completely closed. **NO ONE SHOULD CROSS THE PATH OF THE MOVING DOOR.**
- NEVER** GO UNDER A STOPPED, PARTIALLY OPEN DOOR.
- Test opener monthly. The door **MUST** reverse on contact with a 1-1/2" high object (or 2" x 4" board laid flat) at the center of the doorway on the floor. After adjusting either the force or limit of travel, retest door opener. Failure to adjust the opener properly may cause severe injury or death.
- When possible, use emergency release only when door is closed. Use caution when using this release with the door open. Weak or broken springs are capable of increasing the rate of door closing and increasing the risk of severe injury or death.
- KEEP DOORS PROPERLY BALANCED.** See your garage door Owner's Manual. An improperly balanced door increases the risk of severe injury or death. Have a trained door system technician make repairs to cables, spring assemblies, and other hardware.

SAVE THESE INSTRUCTIONS

⚠ WARNING

- Garage door hardware (springs, cables, brackets, pulleys, etc.) are under extreme pressure and tension.
- DO NOT** attempt to repair or adjust door springs or any hardware, and **DO NOT OPERATE** garage door automatically or manually if door is improperly balanced or springs are broken.
- CONTACT A TRAINED DOOR SYSTEM TECHNICIAN.**

⚠ WARNING

Operator is equipped with grounded electrical plug for your protection, and **only fits grounded electrical outlets. DO NOT** alter plug in any way! **If you have no grounded outlets, have one installed by a licensed electrician.** Operator must be properly grounded to prevent personal injury and equipment damage. **NEVER USE AN EXTENSION CORD!** Check local building codes for any requirement that you must have a permanent hard wired connection. Permanent hard-wired connections must be performed by a licensed electrician using proper tools and instructions.

⚠ WARNING

Use of any other wall control can cause unexpected operation of the door and loss of lighting feature. Locate wall console within sight of the door but far enough from door to prevent contacting it while operating the console. Control must be at least 5 feet above the floor to prevent small children from operating it.

IMPORTANTES CONSIGNES DE SÉCURITÉ

⚠ AVERTISSEMENT

POUR RÉDUIRE LE RISQUE DE BLESSURES GRAVES VOIRE MORTELLES, LIRE ET COMPRENDRE TOUTES LES INSTRUCTIONS.

- NE JAMAIS** permettre aux enfants d'actionner ou de jouer avec les commandes de la porte.
- Tenir les télécommandes hors de la portée des enfants.
- TOUJOURS** garder en vue la porte en mouvement et tenir à l'écart toute personne ou objet jusqu'à ce que la porte soit totalement fermée. **PERSONNE NE DOIT TRAVERSER LA TRAJECTOIRE D'UNE PORTE EN MOUVEMENT.**
- NE JAMAIS** PASSER SOUS UNE PORTE À L'ARRÊT PARTIELLEMENT OUVERTE.
- Tester l'ouvre-porte une fois par mois. La porte de garage **DOIT** inverser sa course au contact d'un objet de 4 cm (planche de 5 sur 10 cm) posé à plat sur le sol au centre de l'ouverture de la porte. Après avoir réglé la force ou la limite de la course, retenter l'ouvre-porte de garage. Un mauvais réglage de l'ouvre-porte peut entraîner des blessures graves voire mortelles.
- Utiliser, dans la mesure du possible le déclenchement d'urgence uniquement lorsque la porte est fermée. Utiliser le déclenchement d'urgence avec prudence lorsque la porte est ouverte. Des ressorts faibles ou brisés peuvent faire descendre la porte rapidement ce qui peut entraîner des blessures graves voire mortelles.
- VEILLER À CE QUE LA PORTE SOIT CORRECTEMENT ÉQUILIBRÉE.** Consulter le manuel du propriétaire de la porte de garage. Une porte déséquilibrée pourrait entraîner de graves blessures voire mortelles. Demander à un technicien spécialisé en système de portes de se charger des réparations des câbles, des ressorts et de toute autre quincaillerie.

CONSERVER CES INSTRUCTIONS

⚠ AVERTISSEMENT

- La quincaillerie de la porte de garage (ressorts, câbles, supports, poulies, etc.) sont sous des pressions et des tensions extrêmes.
- NE PAS** réparer ni régler les ressorts de la porte ou toute autre pièce de quincaillerie et **NE PAS ACTIONNER** la porte manuellement ou automatiquement si elle n'est pas correctement équilibrée ou si des ressorts sont cassés.
- CONTACTEZ UN TECHNICIEN SPÉCIALISÉ EN SYSTÈME DE PORTES**

⚠ AVERTISSEMENT

L'opérateur, qui est équipé d'une prise électrique mise à la terre pour votre protection **est compatible uniquement avec des prises électriques mises à la terre. NE PAS** modifier la fiche d'une quelconque manière. **Si vous n'avez pas de prises mises à la terre, faites-en installer par un électricien agréé.** L'opérateur doit être correctement mis à la terre pour éviter les blessures corporelles et des dommages matériels. **NE JAMAIS UTILISER DE RALLONGE!** Vérifiez les codes locaux des bâtiments pour toute exigence relative à une connexion câblée permanente. Les connexions câblées permanentes doivent être effectuées par un électricien agréé qui se servira d'outils appropriés et respectera les consignes.

⚠ AVERTISSEMENT

L'utilisation d'une autre commande murale pourrait produire des résultats inattendus de la porte ainsi que le dysfonctionnement de l'éclairage. Localisez la console murale en vue de la porte et suffisamment loin de la porte pour éviter tout contact pendant l'utilisation de la console. La commande doit être à une hauteur minimale de 1,5 m au-dessus du sol afin que les jeunes enfants ne puissent pas l'atteindre.

Regular Maintenance

Basic monthly maintenance tasks include:

- Contact Reverse Test
- Lubricate door hardware
- Safe-T-Beam® System check
- Door balance
- Remote Battery Replacement (As needed)
- Light Bulb Replacement (As needed)

A. Contact Reverse Test

See page 8.

B. Lubricate Door Hardware

Inspect door rollers and hinges and lubricate as needed using a light weight general purpose grease.

D. Door Balance (Spring Tension)

Perform the check as follows:

- With the door closed, pull manual emergency release handle to release the carriage from the shuttle (Screw Drive) or the bullet (Chain/Belt Drive).

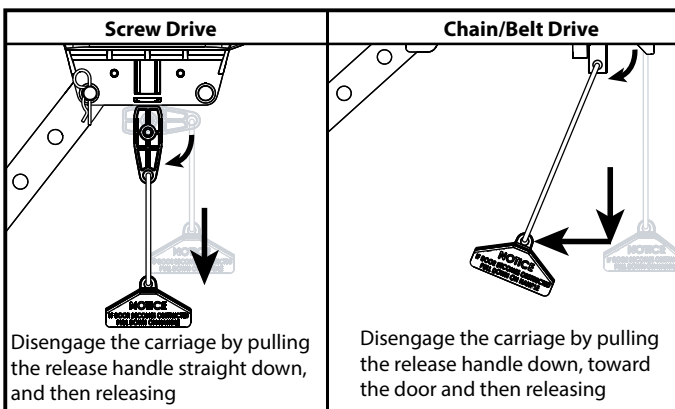

C. Safe-T-Beam® (STB) System Check

Check that both the RED and GREEN LEDs are ON steady. This indicates the system is working properly. If both LEDs are not ON steady, check the appropriate items below:

- STB red LED flashes.
 - Check for obstruction.
 - Check alignment. (See page 18)
 - Verify wire routing from STBs to STB connection in powerhead
 - Check for signal interference from another Safe-T-Beam® unit (for multiple door installations).
- No STB red or green LED displayed.
 - Check wiring and wire connections

If system appears to be working properly, perform check as follows:

1. Start the door closing.
2. Pass an object through the beam. The door should stop and reverse to the fully open position.

- Raise and lower the door manually — it should move freely and smoothly.
- Raise door manually about 3' to 4' feet and let go.

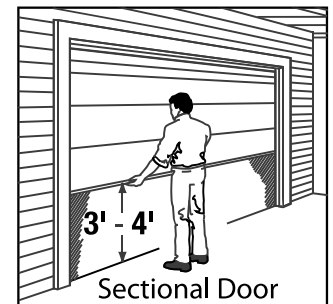

- Door should remain stationary or move very slowly.
- If door moves quickly, CONTACT A TRAINED DOOR SYSTEM TECHNICIAN to have your door springs serviced.
- Close the door.
- Place the carriage in the "engage" position (see illustration reversed).
- Operate door using remote or wall control. The carriage will reattach itself to the drive chain/belt.

E. Remote Battery Replacement (As needed)

Remote Battery Replacement (1-button)

Replace remote battery with a CR2032 coin cell battery.

1. Slide the battery cover off (it's the lower half of the remote's case) by pressing on the case just below the indentation at the top of the cover and sliding it down. *Alternately, insert a coin or small washer into the indentation in the front of the case and pry to unlatch the battery cover in order to slide it off.*
2. Slide out the old battery and slide in the new. **Be sure positive side (+) is UP.**
3. Slide the battery cover on until it snaps into place.

Remote Battery Replacement (3-button)

Replace remote battery with a CR2032 coin cell battery.

1. Open remote case using a washer or coin that fits into the slot on the top of the remote.
2. Replace battery. **Be sure positive side (+) is UP.**
3. Align components and snap case closed.

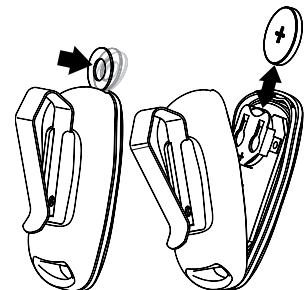

5 Maintenance and Adjustments (continued)

F. Light Bulb Replacement

⚠ WARNING

- Use extreme caution when working from a ladder or step stool or serious injury can occur.
- When replacing light cover, make sure wires are not pinched or near moving parts.
- Use only properly rated incandescent, LED or CFL light bulbs. DO NOT use bulbs with a rating greater than recommended wattage.
- Use A19 size light bulbs. DO NOT use bulbs having a short neck.

⚠ AVERTISSEMENT

- Faire particulièrement attention lors de travaux effectués depuis une échelle ou en escabeau.
- En refermant le couvercle de l'éclairage, s'assurer que les fils ne sont ni coincés ni près des pièces mobiles.
- Utilisez uniquement incandescence correctement classé, LED ou des ampoules fluocompactes.
- NE PAS utiliser des ampoules avec une cote supérieure à recommandée.
- Utilisez A19 ampoules de taille. NE PAS utiliser des ampoules ayant un cou court.

Changing Light Bulbs

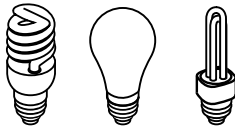

1. Disconnect power to door opener.
Open powerhead light cover
2. Replace old light bulb(s) with new.
 - DO NOT use light bulbs with greater than 100 watt rating.
 - Powerlift 900, GPower 900, DuraDrive, Model 2568 and Model 5042 require light bulbs of no more than 60 watts. CFL or LED bulbs may be used.
 - Close powerhead light cover(s).
3. Reconnect power to door opener.
 - Test light operation.

NOTE: Use of LED bulbs may reduce the range of your remote controls.

Visit www.GenieCompany.com for more information and recommendations for LED bulbs.

Adjustment Guides

⚠ WARNING

TO AVOID INJURY OR DAMAGE

- **NEVER** adjust the force settings to adjust for damage, including an unbalanced door, binding door track or broken spring.
- Perform a CONTACT REVERSE TEST monthly. See page 8.

⚠ AVERTISSEMENT

Pour éviter les blessures ou des dommages

- **NE JAMAIS** régler la force pour compenser des dommages, y compris une porte mal équilibrée, un rail de porte coincant ou des ressorts cassés.
- Tous les mois, EFFECTUEZ LE TEST D'INVERSION AU CONTACT. Voir page 8.

Force Settings

Force settings are pre-programmed at the factory and applied during the Open/Closed Limit settings steps (see page 8). For normal use, these settings should not need adjustments with this unit.

Conditions possibly requiring adjustments are:

1. Doors with very stiff weather seals.
2. Doors that start down, STOP, and reverse before closing.
3. Doors that start up, but STOP before they completely open.

See guide and chart next page-

Maintenance and Adjustments

Press and hold both up and down arrow buttons until round LED turns RED, release buttons. Round BLUE LED will flash 3 times.		
LEDs will now display current UP force setting (See chart).		
Press either arrow button until desired UP force setting is reached.		See Chart
Once setting is chosen, press and release. This will lock the UP force setting.		
LEDs will now show current DOWN force setting. (See Chart).		
Press either arrow button until desired DOWN force setting is reached.		See Chart
Once setting is chosen, press and release. This will lock the DOWN force setting.		
The LEDs will now turn BLUE then off. This confirms that both force settings have been set and unit is ready for normal operation.		
Repeat "Learn Force Limits and Contact Reverse Test" page 8		

FORCE SETTINGS CHART

LED indicator colors: ○ OFF ● Blue ○ Purple ● Red

Force Level	Powerhead LEDs		
	LONG LED	ROUND LED	
Force Level 1	Off		BLUE
Force Level 2	BLUE		Off
Force Level 3	BLUE		BLUE
Force Level 4	Off		PURPLE
Force Level 5	PURPLE		Off
Force Level 6	PURPLE		PURPLE
Force Level 7	Off		RED
Force Level 8	RED		Off
Force Level 9	RED		RED

Resetting Travel Limits

See pages 6-7-8 to reset travel limits. Force setting and contact reverse test must be performed in the event of a travel limit change.

NOTE: The opener will not close automatically unless the Safe-T-Beam® System is installed and Limits are programmed.

Speed Settings (DC motors only except 5042)

Speed settings are pre-programmed at the factory for the maximum speed. Speed settings should not need adjustment with this unit. However, travel speed for the opener can be adjusted to a slower speed in both the Open and Close directions, to minimize wear on heavier sectional doors.

There are three speed settings available for sectional doors. Please note that speed may be affected by door weight and balance, along with condition of door components and tracks.

Action	LED Indication/Result
1 Press and hold for about 10 seconds or until both LEDs turn BLUE. Then release.	 BLUE BLUE
2 Press twice.	 BLUE BLUE
3 Press and release.	 OFF Flashes BLUE 3 Times. Then the Current Speed setting for OPENING travel will display. SEE CHART IN NEXT COLUMN.
4 Press either until you reach the desired setting.	 NOTE: Depending on the criteria mentioned above, you may not have the option to increase speed.
5 Press and release.	 LOCKS IN OPENING SETTING. Flashes BLUE 3 Times OFF Then the Current Speed setting for CLOSING travel will display. SEE CHART IN NEXT COLUMN.
6 Press either until you reach the desired setting.	 NOTE: Depending on the criteria mentioned above, you may not have the option to increase speed.
7 Press and release. Both LEDs FLASH BLUE to confirm setting.	 FLASH BLUE FLASH BLUE
8 Repeat "Learn Force Limits" and "Contact Reverse Test" on page 11.	

LED indicator colors: ○ OFF ● Blue ○ Purple ○ Red

Speed Level	Powerhead LEDs		
	LONG LED	ROUND LED	
High	RED		RED
Medium	PURPLE		PURPLE
Low	BLUE		BLUE

5

Maintenance and Adjustments

LOCATING SAFE-T-BEAM® PAIRS

Transmitter (RED LED) and Receiver (GREEN LED)

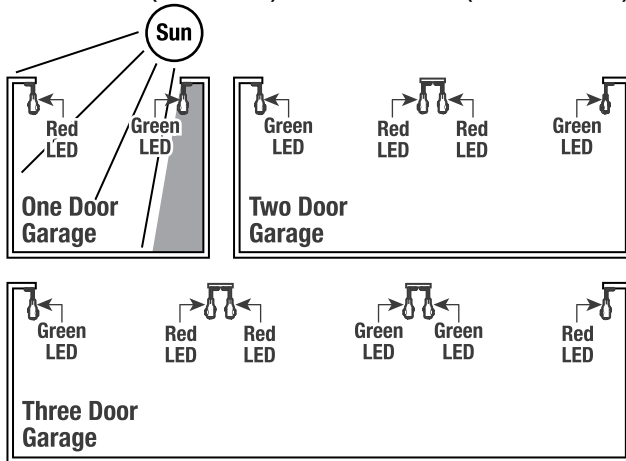

Multiple Garage Doors

- NEVER position Safe-T-Beam® modules where signals will cross.
- Place the Transmitter (Red LED) Safe-T-Beams on adjacent doors facing in opposite directions.

NOTE: Direct sunlight creates interference with Safe-T-Beam® Receiver (Green LED). STB modules CAN be positioned further away from the door opening if necessary to avoid sunlight but no further off the wall to maintain alignment with the Transmitter (Red LED) module.

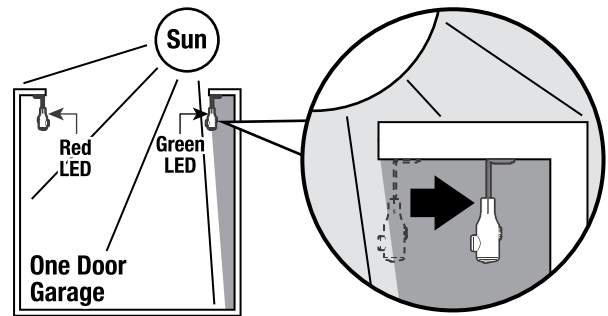

Single Garage Door

- Determine which side of the garage receives direct sunlight.
- Position the Transmitter (Red LED) on the direct sunlight side.

6

Wiring Diagram (Basic Circuit—This diagram is for reference only.)

WARNING



ELECTRICAL SHOCK

OPENING COVER MAY CAUSE ELECTRICAL SHOCK
Disconnect power from opener prior to removing cover

AVERTISSEMENT



CHOC ÉLECTRIQUE

OUVERTURE DE COUVERTURE PEUT PROVOQUER CHOC ÉLECTRIQUE.
Coupez l'alimentation du premier match avant de retirer le couvercle.

POWER CORD

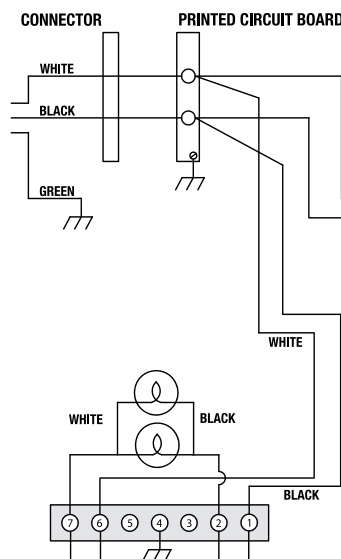

CHAIN MOTOR SCREW DRIVE MOTOR

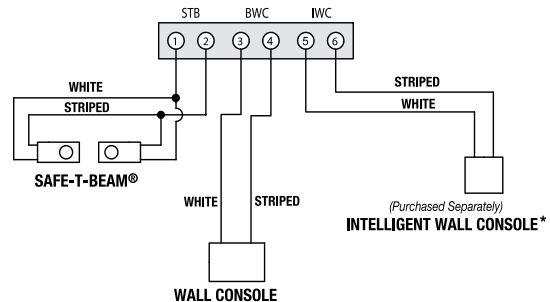
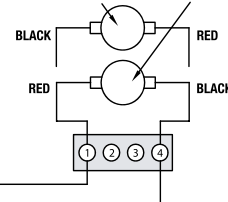

MOTION DETECTOR*

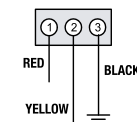

OPTICAL SENSOR*

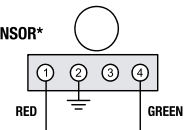



Need help or have questions? **DO NOT RETURN** to the store.

Visit www.genicompany.com or call Customer Service at 1-800-35-GENIE.

PROBLEM:	WHAT TO DO:
Opener does NOT operator when wall control is pressed.	<ul style="list-style-type: none"> • Turn Sure-Lock™ OFF See page 4. • Check power source. <ul style="list-style-type: none"> – Plug a lamp into outlet used for powerhead. If lamp works, power source is OK. – If not, check fuse or circuit breaker. • If power is OK, <ul style="list-style-type: none"> – Check connections at powerhead terminals and at wall console. • Check for reversed, broken or cut wires. Staples can cut insulation and short wires. Repair or replace.
Opener runs, but door does not move.	<ul style="list-style-type: none"> • Make sure carriage is engaged with chain/belt turnbuckle. Refer to installation poster or download poster from www.GenieCompany.com • Check to make sure chain/belt is not broken or off its pulley.
Opener works from wall control, but NOT from remote.	<ul style="list-style-type: none"> • Check all remotes. • Replace remote battery. See page 15. • Program remotes to powerhead. See page 9.
Remote has less than 25 feet operating range or no operation.	<ul style="list-style-type: none"> • Relocate remote inside car and /or point remote at garage door. • Replace battery. See page 15. • Reposition door opener antenna. • Eliminate possible competing signals (radio, etc.). • LED bulbs may be interfering with remote signal. See page 16.
Door starts down, then STOPS and goes back up. OR Safe-T-Beam® System malfunction.	<ul style="list-style-type: none"> • If a NEW installation, check Door Arm position. Refer to Installation poster or download poster from www.GenieCompany.com. • Check if limits are properly set. See pages 6-7. Adjust limits as needed. • Check if Safe-T-Beam® red LED is flashing. See page 15, Safe-T-Beam® system check. • Check Safe-T-Beam® system for beam obstruction or misalignment of lenses. See page 15, Safe-T-Beam® system. • Check garage door for binding. • If an operational problem exists, and opener will not close, the opener can be forced to close as follows: Press and hold the wall control button until door is completely closed. • Check for interference from adjacent Safe-T-Beam® units. See page 18. • Contact Genie at 1-800-35-GENIE.
Door starts down, then STOPS before it is closed. OR Door will only open.	<ul style="list-style-type: none"> • Check Safe-T-Beam® wire connection at powerhead and at STBs. See page 15, Safe-T-Beam® system check. • Check if limits are properly set. See pages 6-7. Adjust limits as needed. • Check CONTACT REVERSE. See page 8. • Check garage door for binding. See maintenance and adjustment. Pages 14-18. • Check closing "FORCE" control. See page 8, or Force settings. Page 17.
Door starts up, but STOPS before it is completely open.	<ul style="list-style-type: none"> • Check if limits are properly set. See pages 6-7. Adjust limits as needed. • Be sure door, opener, springs are in good repair, properly lubricated and balanced. • Check closing/opening "FORCE" control. See page 8, or Force settings Page 17. • If you suspect a problem with the garage door hardware or springs, visit www.GenieCompany.com and use the "dealer locator" to hire a local door service professional. <p>NEVER try to repair door hardware or springs yourself.</p>
Door will only run closed.	<ul style="list-style-type: none"> • Turn Sure-Lock™ OFF See page 4. • Check if limits are properly set. See pages 6-7. • Check door balance, condition, and door spring. • Check opening "FORCE" control. See page 8, or Force settings. Page 17. • If you suspect a problem with the garage door hardware or springs, visit www.GenieCompany.com and use the "dealer locator" to hire a local door service professional. <p>NEVER try to repair door hardware or springs yourself.</p>
Door opener starts for no reason.	<ul style="list-style-type: none"> • Button stuck on wall control or remote. • Was remote lost or stolen? Erase all remotes from powerhead memory and program new remotes. See pages 9-13.

7

Troubleshooting

OPERATION (continued)

PROBLEM	WHAT TO DO
Noisy operation.	<ul style="list-style-type: none"> • Be sure all door fasteners are tight. • Be sure garage door is in good repair, properly lubricated and balanced. • Be sure opener is in good repair.
Door opener runs slow.	<ul style="list-style-type: none"> • Check operating condition of door. Door may need professional repair/adjustment. • Is this opener installed on a one-piece door? This opener is not designed to operate a one-piece door.

POWERHEAD LEDS

Powerhead LED		Possible Problem	Solution
Round LED	Long LED		
OFF	OFF	Normal operation.	None required.
		No response from unit.	Check power supply. Contact a trained door system professional.
ON/RED/ STEADY	ON/RED/ STEADY	Limits NOT set properly.	Re-program limits, see pages 6-7.
ON/RED/ FLASHING	ON/RED/ FLASHING	Program error.	Unplug unit, wait 5 seconds, plug in.
		Component failure.	Contact a trained door system technician.
ON/BLUE/ FLASHING	OFF	Remote NOT programmed.	Program remote, see page 9.
ON/PURPLE/ FLASHING	OFF	Remote NOT programmed.	Program remote, see page 9.
ON/RED/ FLASHING	OFF	Safe-T-Beam® physical obstruction.	Remote obstruction, recheck unit.
		Safe-T-Beam® signal interference.	Check alignment of Safe-T-Beam® pair and nearest other Safe-T-Beam® pair, see page 15.
OFF	ON/RED/ FLASHING	Door contact in UP or DOWN travel.	Remove obstruction.
		Door component failure detected.	Check door spring, track, rollers, hinges and fixtures.
OFF	ON/RED/ STEADY	Thermal cutout.	DO NOT unplug unit. Wait until LED clears before operating.
ON/PURPLE/ STEADY	ON/PURPLE/ STEADY	Component error.	Contact a trained door system technician.
OFF	ON/BLUE/ FLASHING	Door will not open.	Check Sure-Lock™. Sure-Lock™ should be OFF for normal operation (see page 4).
ON/PURPLE/ FLASHING	ON/PURPLE/ FLASHING	Radio receiver error.	Unplug the unit. Wait 5 seconds and plug the unit back in. If problems persist, contact a trained door system technician.

ATTACHING DOOR BRACKET TO DOOR FRAME

- 1a. Using the bracket as your guide, mark the hole positions on the door frame. Center the bracket on the door, as high as possible, preferably the top edge.

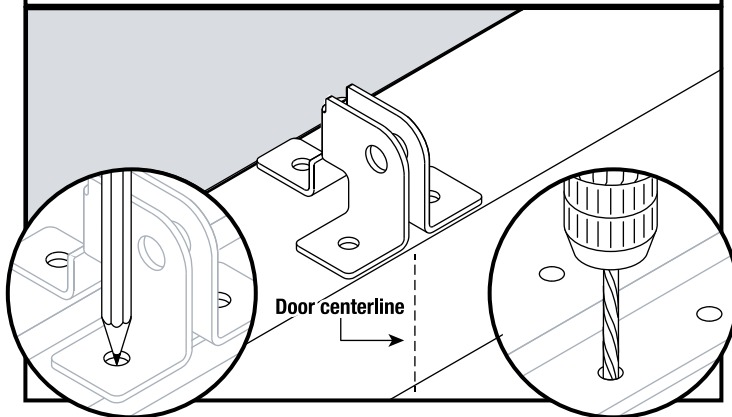

- 1b. Secure the bracket:

Preferred method: Drill 9/32" pilot holes completely through the door. Secure the bracket with 1/4"-20 carriage bolts and nuts (not supplied).

Alternate method: Drill 1/8" pilot holes partially through the door. Secure the bracket with 1/4" x 1-1/2" (minimum length) lag screws (not supplied).

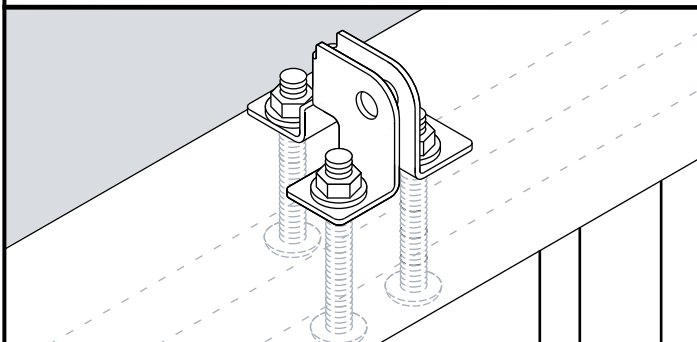

TYPICAL
ONE-PIECE DOOR
INSTALLATION

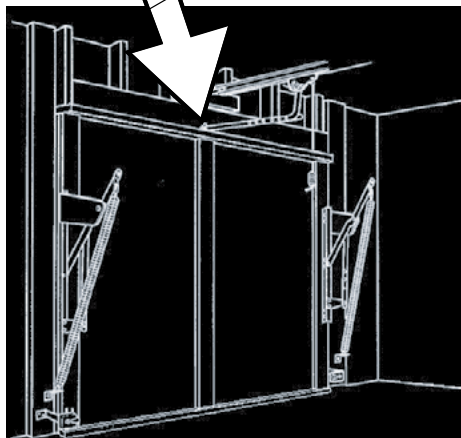

ATTACHING DOOR ARM TO DOOR BRACKET

- 2a. Screw drive models:
One-piece doors must be connected to a straight door arm as shown.

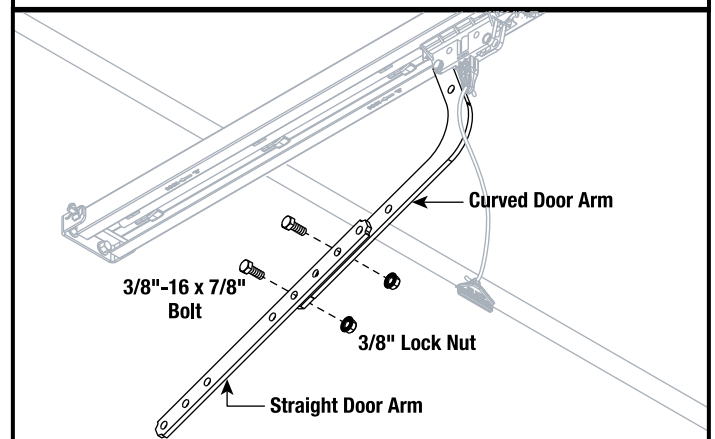

- 2b. Chain and Belt models:

One-piece doors must be connected to a straight door arm.

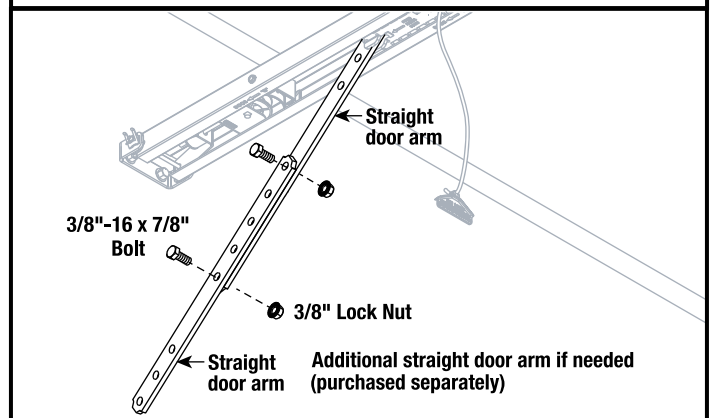

3. Secure the straight door arm to the door bracket with clevis pin and cotter pin.

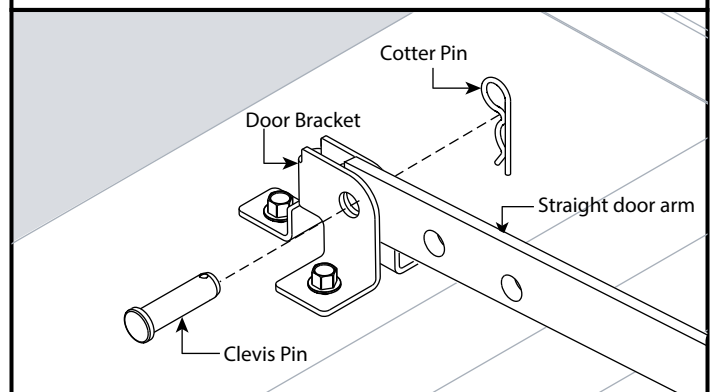



2562, 2568, 3022, 3024, 3042, 3062, 3064, 4024, 4042, 4062, 4064, 5042, SC1200, CB1000, CB1200 Limited Warranty

GMI Holdings, Inc. d/b/a The Genie Company ("Seller") warrants to the original purchaser of the Models 2562, 2568, 3022, 3024, 3042, 3062, 3064, 4024, 4042, 4062, 4064, 5042, SC1200, CB1000, or CB1200 garage door opener ("Product"), subject to all of the terms and conditions hereof, that the Product and all components thereof will be free from defects in materials and workmanship for the following period(s) of time, measured from the date of purchase:

MOTOR/GEARBOX –

Models 3022, 3024, 3042, 3062, 3064, 4024, 4042, 4062, 4064, CB1000, CB1200, SC1200 - LIMITED LIFETIME*

Models 2562, 2568 and 5042 - FIFTEEN (15) YEARS

DRIVE SCREW for Screw Drive Product

Models 3062, 3064 AND 4062, 4064 – LIMITED LIFETIME*

Models 2562 AND 2568 –FIVE (5) YEARS

or

BELT - FIFTEEN (15) YEARS for Belt Drive Product

or

CHAIN - FIVE (5) YEARS for Chain Drive Product

ACCESSORIES - ONE (1) YEAR

CORE UNIT PARTS** -

Models 3022, 3024, 3042, 3062, 3064, 4024, 4042, 4062, 4064, 5042, SC 1200, CB1000 and CB1200 - FIVE (5) YEARS.

Models 2562 and 2568 - THREE (3) YEARS

OTHER PARTS - Parts and components not part of the Core Unit** - ONE (1) YEAR

*"Limited Lifetime" shall mean for as long as the original purchaser owns the home in which the Product is originally installed

** The "Core Unit" consists of the power head, wired wall control, Safe-T-Beam® system, J-Arm and rail.

Seller's obligation under this warranty is specifically limited to repairing or replacing, at its option, the Product or any part thereof which is determined by Seller to be defective during the applicable warranty period. Any labor charges are excluded and will be the responsibility of the purchaser.

This warranty gives you specific legal rights, and you may also have other rights which vary from state to state. This warranty is made to the original purchaser of the Product only, and is not transferable or assignable. This warranty applies only to Product installed in a residential or other non-commercial application. It does not cover any Product installed in commercial or industrial building applications. This warranty does not apply to any unauthorized or improper installation, alteration or repair of the Product, or to any Product or component which has been damaged or deteriorated due to misuse, neglect, accident, failure to provide necessary maintenance, failure to follow owner's manual instructions, normal wear and tear, or acts of God or any other cause beyond the reasonable control of Seller, and does not cover batteries, use of extension cord, missing or damaged parts from clearance or open box sales, or repairs or maintenance to door components.

ALL EXPRESS AND IMPLIED WARRANTIES FOR THE PRODUCT, INCLUDING BUT NOT LIMITED TO ANY IMPLIED WARRANTIES OF MERCHANTABILITY AND FITNESS FOR A PARTICULAR PURPOSE, ARE LIMITED IN TIME TO THE APPLICABLE WARRANTY PERIOD REFLECTED ABOVE. NO WARRANTIES, WHETHER EXPRESS OR IMPLIED, WILL APPLY AFTER THE LIMITED WARRANTY PERIOD HAS EXPIRED. Some states do not allow limitations on how long an implied warranty lasts, so the above limitation may not apply to you.

IN NO EVENT SHALL GMI HOLDINGS, INC. OR ITS PARENT OR AFFILIATES BE RESPONSIBLE FOR, OR LIABLE TO ANYONE FOR, SPECIAL, INDIRECT, COLLATERAL, PUNITIVE, INCIDENTAL OR CONSEQUENTIAL DAMAGES, even if Seller has been advised of the possibility of such damages. Such excluded damages include, but are not limited to, loss of use, cost of any substitute product, or other similar indirect financial loss. Some states do not allow the exclusion or limitation of incidental or consequential damages, so the above limitation or exclusion may not apply to you.

Claims under this warranty must be made promptly after discovery and within the applicable warranty period. To obtain warranty service, you must contact Genie® customer service toll free at 1-800-354-3643 to speak with a trained representative and attempt reasonable troubleshooting measures, as well as provide proof of the date and location of purchase, identification as the original purchaser and a description of the claimed defect. Purchaser must allow Seller a reasonable opportunity to inspect the Product claimed to be defective prior to removal or alteration of its condition. Upon determination by Seller that the Product or any part thereof is defective during the applicable warranty period (which may require purchaser to return the Product to Seller at purchaser's expense), Seller will supply the purchaser with replacement parts or, at its option, a replacement Product (shipping and handling of any replacement Product or parts also at purchaser's expense). Seller may use new or reconditioned parts, or a new or reconditioned Product of the same or similar design.

There are no established informal dispute resolution procedures of the type described in the Magnuson-Moss Warranty Act

Register your warranty at our website. http://www.GenieCompany.com/support_warranty.aspx

PURCHASER: _____
INSTALLATION ADDRESS: _____
DATE PURCHASED: _____
OPENER MODEL: _____
REMOTE CONTROL MODEL: _____
DATE OF INSTALLATION: _____
NAME OF DISTRIBUTOR/INSTALLER: _____
ADDRESS OR DISTRIBUTOR/INSTALLER: _____
SERIAL NUMBER: _____

Free Manuals Download Website

<http://myh66.com>

<http://usermanuals.us>

<http://www.somanuals.com>

<http://www.4manuals.cc>

<http://www.manual-lib.com>

<http://www.404manual.com>

<http://www.luxmanual.com>

<http://aubethermostatmanual.com>

Golf course search by state

<http://golfingnear.com>

Email search by domain

<http://emailbydomain.com>

Auto manuals search

<http://auto.somanuals.com>

TV manuals search

<http://tv.somanuals.com>