

EB-190



EB-195



### Specifications

- Fail-Safe Version (Power to Lock)
- Power Input: 12 V/24V DC (self-regulating)
- Voltage Tolerance: + -10%
- Current Draw:  
Pull in: 0.9A, Holding: 0.3A@12V DC (at temperature 20?)
- BSS output: Magnetic bolt status output (SPDT rated 3A@30VDC) indicates bolt locked or unlocked status.
- DPS output: Indicates door position (opened or closed), Reed rated 0.25Amp@30VDC.
- Operating Temperature: -10~+45?
- Humidity: 0~95% non-condensing.
- Lock's surface Temperature (when the power is on): <current temperature +20?
- Tested to 500000 cycles.
- Built-in logical circuitry
- Auto-relocking Time Delay : 0, 3 ,6 ,9seconds
- Face Plate Material: stainless steel
- Weight: 0.6 Kg

### Double Acting Doors

EB-190 Electric dropbolt is specially designed for use on double swinging doors. They can also be installed on both out and in-swinging doors.

### Dimension

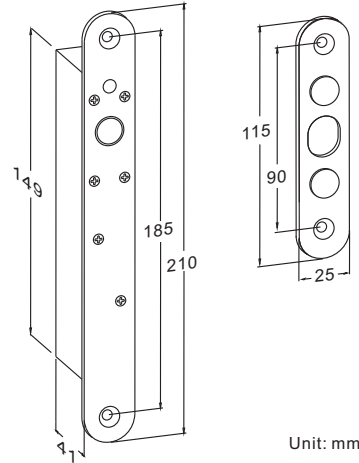

### Statement

The EB-190 electric dropbolt is the upgraded version of EB-180. The 25mm wider faceplate is designed for installation in virtually all types of doors and frames. The bolt status switch sensor and door position status sensor have been added. The rectangular-shaped (EB-195) and arc-shaped (EB-190) faceplate is used to suit the different users' habits of installations.

### DPS & BSS output

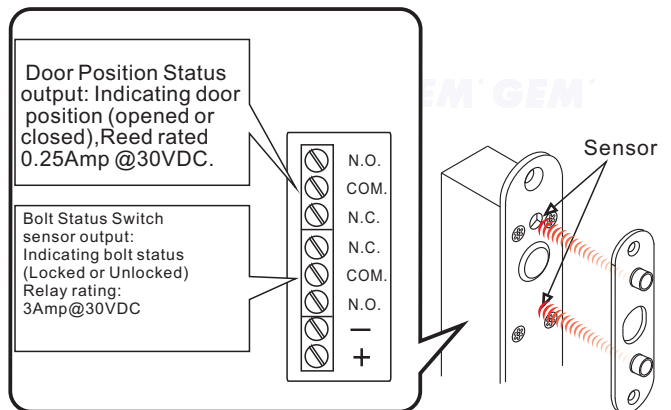

### Solid bolt for superior strength

Greater security is provided by the 13.5mm diameter (16mm bolt throw) solid stainless steel bolt with hardened magnet core, which has resistant to metal cutting saws. The bolt also rotates freely, making attempts to tamper or cut extremely difficult.

## GIANNI INDUSTRIES, INC.

No. 13, Zhong Sing Road, Tu-Cheng Industrial Zone,  
Tu-Cheng City, Taipei, Taiwan 23678  
Tel: 886-2 2267 7986 / Fax: 886-2 2267 9876  
E-Mail: info@gianni.com.tw  
Website: gianni.tw  
Copyright 2008 Gianni industries, inc. All rights reserved.  
DM-CA-EB-190 Ver. D Published on 2008.10.20



The products are manufactured under an ISO 9001 & QC 080000 Certified Quality Management Program environment back its product quality, performance and commitment to customer satisfaction.

### ● Long life solenoids

Special designed solenoid for strength and long life operating lifetime with guaranteed 500,000 operations.

### ● Clamp Design

When the bolt is extended to keep the door locked, it draws only 0.3A in a holding mode down from 0.9A while the bolt is retracted. This design both protects the power supply and extends the life of the electric dropbolt.

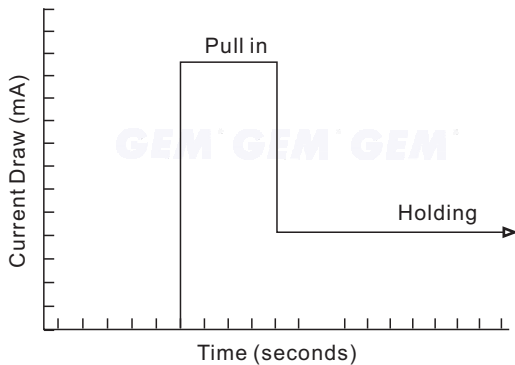

### ● Horizontal or vertical installation

GEM's electric dropbolts can be installed either horizontally at the top or bottom of the door frame or vertically on the side of the door frame.

Fig. A Horizontal Installation (Frame Header)

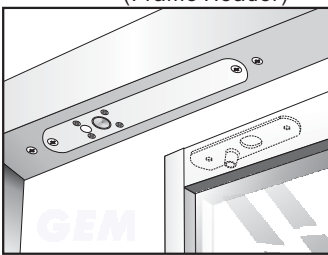
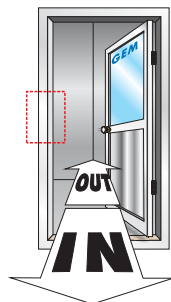
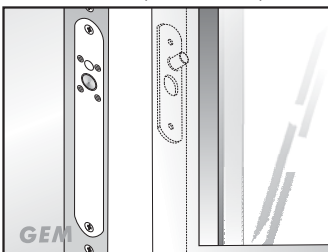
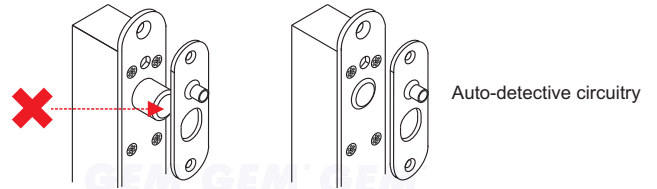

Fig. B Vertical Installation (Side Jamb)



### ● Auto-detective circuitry

The unique intelligent logic circuit in GEM's electric dropbolts keeps the bolt retracted whilst the door is unlocked until the door is properly closed. This feature ensures the bolt will not extend if the door is improperly aligned.



### ● Smart Circuitry

The vandal resistant circuitry means the door close sensor can't be fooled into projecting the electric dropbolt unless the door is actually closed. The reed sensor automatically disconnects after the bolt is projected to enhance security of the lock.

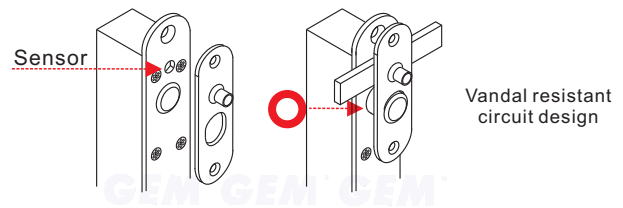

### ● Breakthrough in innovation ideas

Unobtrusive and slim design can be flush mounted directly into metal such as door mullions.

### ● Lock Delay Settings

The door locking delay is the time between the door being closed and the bolt engaging. This can be set to up to 9 seconds at 3 second intervals by adjusting the jumpers.

#### Auto Relocking Timer Setting

ON <input type="checkbox"/> 1 <input type="checkbox"/> 2	ON <input type="checkbox"/> 1 <input type="checkbox"/> 2	ON <input type="checkbox"/> 1 <input type="checkbox"/> 2	ON <input type="checkbox"/> 1 <input type="checkbox"/> 2
↑	↑	↑	↑
0 seconds	3 seconds	6 seconds	9 seconds

### ● Warranty

The product is warranted against defects in material and workmanship while used in normal service for a period of 1 year from the date of sale to the original customer. The GEM policy is one of continual development and improvement; therefore GEM reserves the right to change specifications without notice.

## GIANNI INDUSTRIES, INC.

No. 13, Zhong Sing Road, Tu-Cheng Industrial Zone,  
Tu-Cheng City, Taipei, Taiwan 23678  
Tel: 886-2 2267 7986 / Fax: 886-2 2267 9876  
E-Mail: info@gianni.com.tw  
Website: gianni.tw  
Copyright 2008 Gianni industries, inc. All rights reserved.  
DM-CA-EB-190 Ver. D Published on 2008.10.20



The products are manufactured under an ISO 9001 & QC 080000 Certified Quality Management Program environment back its product quality, performance and commitment to customer satisfaction.

## Free Manuals Download Website

<http://myh66.com>

<http://usermanuals.us>

<http://www.somanuals.com>

<http://www.4manuals.cc>

<http://www.manual-lib.com>

<http://www.404manual.com>

<http://www.luxmanual.com>

<http://aubethermostatmanual.com>

Golf course search by state

<http://golfingnear.com>

Email search by domain

<http://emailbydomain.com>

Auto manuals search

<http://auto.somanuals.com>

TV manuals search

<http://tv.somanuals.com>