



Statement

The EB-400 electric dropbolt is designed for surface mount application and this lock's casing is made of stainless steel plates which this lock construction is rugged. Other functions comes all the same with EB-220.

Specifications

- Fail-Safe Version (Power to Lock)
- Power Input: 12 V DC
- Voltage Tolerance: 10%
- Current Draw:
- Pull in: 0.9A, Holding: 0.3A@12V DC (at temperature 20°C)
- Magnetic bolt status output (SPDT rated 3A@30VDC) indicates bolt locked or unlocked status.
- Operating Temperature: -10~+45C
- Humidity: 0~95% non-condensing.
- Lock's surface Temperature (when the power is on): <current temperature +20C
- Tested to 500000 cycles.
- Built-in logical circuitry
- Auto-relocking Time Delay : 0, 3 ,6 ,9seconds
- Full stainless steel housing
- Weight (Approx.): 1.4 Kg

Double Acting Doors

EB-400 Electric dropbolt is specially designed for use on double swinging doors. They can also be installed on both out and in-swinging doors.

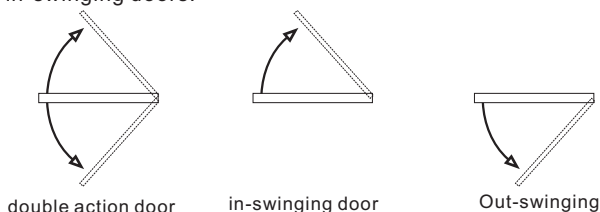

Dimension

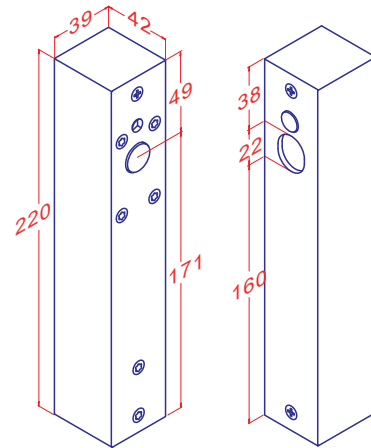

Unit: mm

Solid bolt for superior strength

Greater security is provided by the 16mm diameter (16mm bolt throw) solid stainless steel bolt with hardened magnet core, which has resistant to metal cutting saws. The bolt also rotates freely, making attempts to tamper or cut extremely difficult.

Smart Circuitry

The vandal resistant circuitry means the door close sensor can't be fooled into projecting the electric dropbolt unless the door is actually closed. The reed sensor automatically disconnects after the bolt is projected to enhance security of the lock.

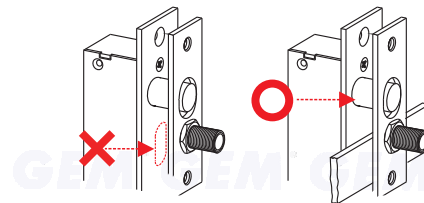

Auto-detective circuitry

The unique intelligent logic circuit in GEM's electric dropbolts keeps the bolt retracted whilst the door is unlocked until the door is properly closed. This feature ensures the bolt will not extend if the door is improperly aligned.

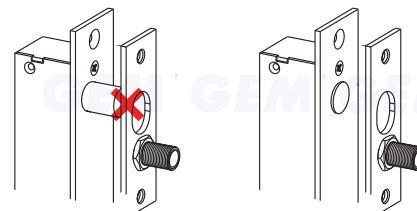

GIANNI INDUSTRIES, INC.

No. 13, Zhong Sing Road, Tu-Cheng Industrial Zone,
 Tu-Cheng City, Taipei, Taiwan 23678
 Tel: 886-2 2267 7986 / Fax: 886-2 2267 9876
 E-Mail: info@gianni.com.tw
 Website: gianni.tw
 Copyright 2008 Gianni industries, inc. All rights reserved.
 DM-CA-EB-400 Ver. E Published on 2008.10.20



The products are manufactured under an ISO 9001 & QC 080000 Certified Quality Management Program environment back its product quality, performance and commitment to customer satisfaction.

● Horizontal or vertical installation

GEM's electric dropbolts can be installed either horizontally at the top or bottom of the door frame or vertically on the side of the door frame.

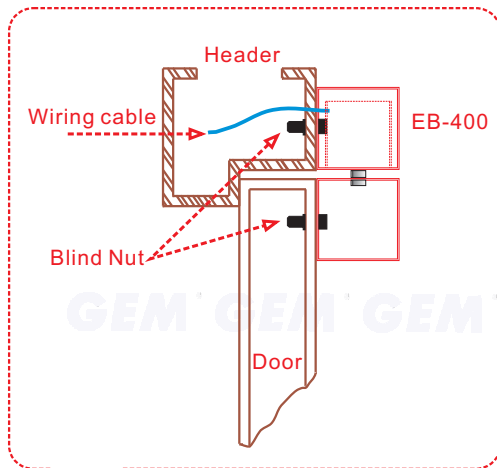

● Long life solenoids

Special designed solenoid for strength and long life operating lifetime with guaranteed 500,000 operations.

● Clamp Design

When the bolt is extended to keep the door locked, it draws only 0.3A in a holding mode down from 0.9A while the bolt is retracted. This design both protects the power supply and extends the life of the electric dropbolt.

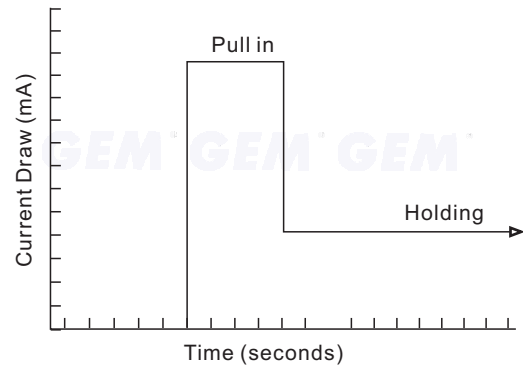

● Adjustable Sensor

The door close sensor can work up to a range of 5mm. If there is a wide door gap, a sensor magnet within the strike plate of the door can be adjusted to improve sensor accuracy.

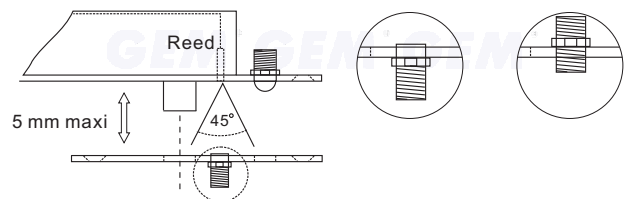

● Auto Relocking Timer Setting

Use jumpers to adjust the time between 0 to 9 seconds for door locking time delay. This is the time, which takes the Dropbolt to automatically lock after the door is closed.

Auto Relocking Timer Setting

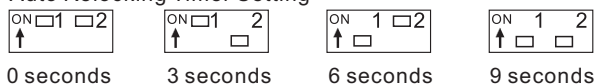

● Warranty

The product is warranted against defects in material and workmanship while used in normal service for a period of 1 year from the date of sale to the original customer. The GEM policy is one of continual development and improvement; therefore GEM reserves the right to change specifications without notice.

GIANNI INDUSTRIES, INC.

No. 13, Zhong Sing Road, Tu-Cheng Industrial Zone,
 Tu-Cheng City, Taipei, Taiwan 23678
 Tel: 886-2 2267 7986 / Fax: 886-2 2267 9876
 E-Mail: info@gianni.com.tw
 Website: gianni.tw
 Copyright 2008 Gianni industries, inc. All rights reserved.
 DM-CA-EB-400 Ver. E Published on 2008.10.20



The products are manufactured under an ISO 9001 & QC 080000 Certified Quality Management Program environment back its product quality, performance and commitment to customer satisfaction.

Free Manuals Download Website

<http://myh66.com>

<http://usermanuals.us>

<http://www.somanuals.com>

<http://www.4manuals.cc>

<http://www.manual-lib.com>

<http://www.404manual.com>

<http://www.luxmanual.com>

<http://aubethermostatmanual.com>

Golf course search by state

<http://golfingnear.com>

Email search by domain

<http://emailbydomain.com>

Auto manuals search

<http://auto.somanuals.com>

TV manuals search

<http://tv.somanuals.com>