

■ Application for the Electromagnet:
EM-150

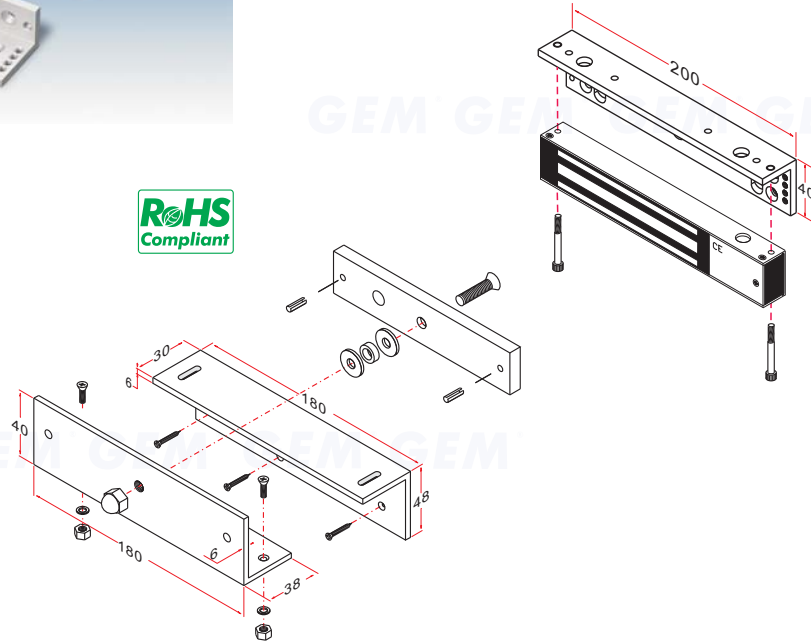

Unit:mm

Installation Steps of LZ bracket for In-swinging doors

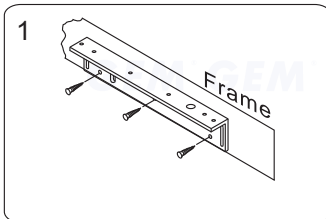

1 Find a mounting location on the door frame for the L bracket. Make sure that the door is still closeable.

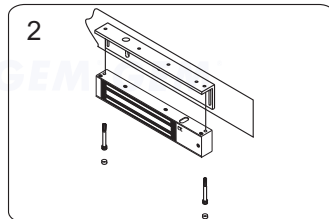

2 Tighten the electromagnetic lock on the L bracket by using the fixing screw.

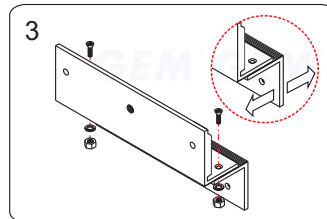

3 Assemble the Z bracket, and make sure that the Z bracket is adjustable.

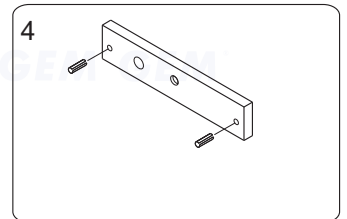

4 Insert the guide pins into the armature plate.

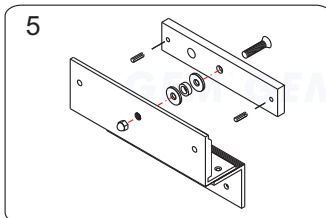

5 Put one rubber washer between armature plate and the Z bracket.

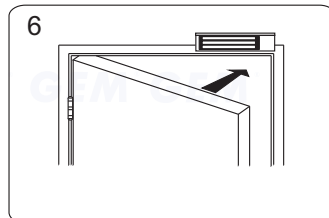

6 Close the door. Measure the correct position by bringing the armature plate close to the contact surface of the electromagnetic lock.

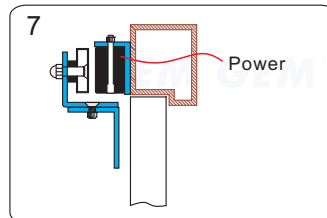

7 Turn on the power of EM-Lock, and let the armature plate bonds to the EM-lock. Adjust the position between the Z bracket and the door frame.

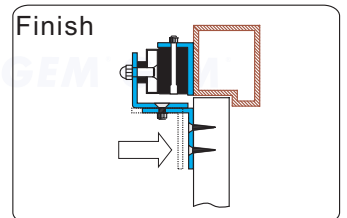

Finish Once the position is correct, use the screws to permanently mount the Z bracket on the door frame. This should be the last step.

GIANNI INDUSTRIES, INC.

No.306-1, Hsin Shu Road, Hsin Chuang, Taipei, Taiwan 242
 TEL: 886-2-2206 9929 FAX: 886-2-2204 6632
 E-Mail: info@gianni.com.tw
 Website: gianni.tw

Copyright © 2008 Gianni industries, inc. All rights reserved.
 DM-CA-LZ-EM150 Ver. C Published on 2008.05.20



The products are manufactured under an ISO 9001 & QC 080000 Certified Quality Management Program environment back its product quality, performance and commitment to customer satisfaction.

Free Manuals Download Website

<http://myh66.com>

<http://usermanuals.us>

<http://www.somanuals.com>

<http://www.4manuals.cc>

<http://www.manual-lib.com>

<http://www.404manual.com>

<http://www.luxmanual.com>

<http://aubethermostatmanual.com>

Golf course search by state

<http://golfingnear.com>

Email search by domain

<http://emailbydomain.com>

Auto manuals search

<http://auto.somanuals.com>

TV manuals search

<http://tv.somanuals.com>