

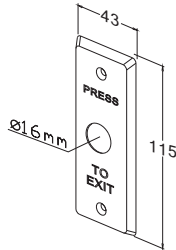

PBT-010
Stainless steel faceplate

Max. Ratings : 5A@250 Vac, 6A@24V DC
 Type of actuation: Momentary
 Contact arrangement: Double pole double throw
 Operating travel: 3.2 mm
 Operating temp. Range: -20~+70C
 Contact resistance: 50 mΩ Max.(initial)
 Operating life(Mechanical) : Over 100,000 times
 Materials(Button): PVC, Faceplate: Stainless steel



Free Position

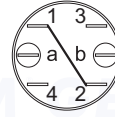

Operation Position

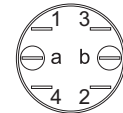
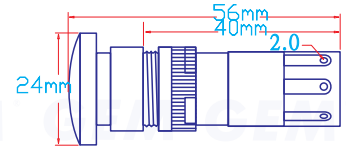
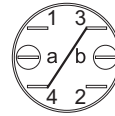

1,2=N/C
 3,4=N/O
 a,b (Null)

(S-SI-PBT)



PBT-020-4
Stainless steel faceplate

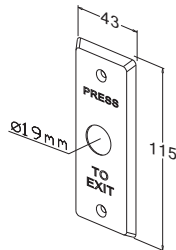

Free Position

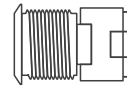

Operation Position

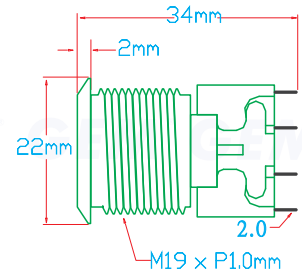

(S-SI-PBT-4-GEM)



PBT-025-4
Aluminum anodized faceplate

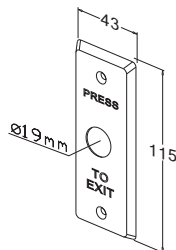

Switch Specifications

Max. Ratings : 5A@125/250 Vac
 Type of actuation: Momentary
 Contact arrangement: Double pole double throw
 Operating travel: 2.7 mm
 Operating temp. Range: -20~+70C
 Contact resistance: 50 mΩ Max.(initial)
 Operating life(Mechanical) : Over 100,000 times
 Materials: Stainless steel



PBT-026-4
Aluminum anodized faceplate

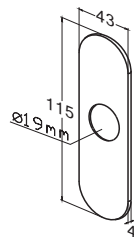

GIANNI INDUSTRIES, INC.

No. 13, Zhong Sing Road, Tu-Cheng Industrial Zone,
 Tu-Cheng City, Taipei, Taiwan 23678
 Tel: 886-2 2267 7986 / Fax: 886-2 2267 9876
 E-Mail: info@gianni.com.tw
 Website: gianni.tw
 Copyright 2008 Gianni industries, inc. All rights reserved.
 DM-CA-PBT-Special Ver. F Published on 2008.05.28



The products are manufactured under an ISO 9001 & QC 080000 Certified Quality Management Program environment back its product quality, performance and commitment to customer satisfaction.



PBT-020-2
Stainless steel faceplate

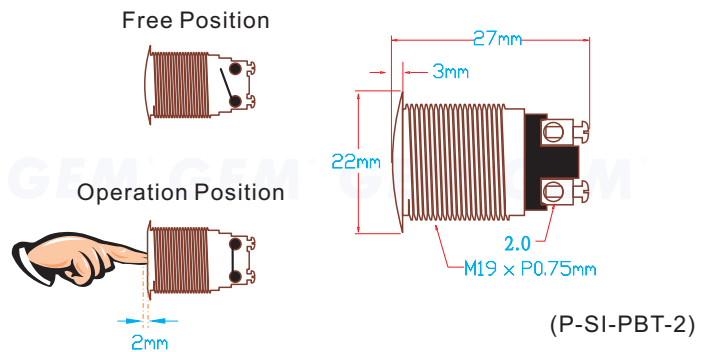
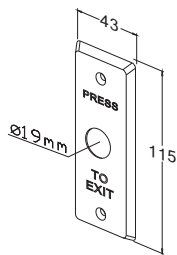

PBT-200-2
Stainless steel faceplate

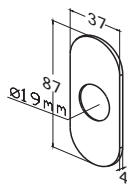

Switch Specifications

Max. Ratings : 3A@125V AC, 6A@24V DC
 Type of actuation: Momentary
 Contact arrangement: normal open (N.O.)
 Operating travel: 2.0 mm
 Operating temp. Range: -20~+70C
 Contact resistance: 50 mΩ Max.(initial)
 Operating life(Mechanical) : Over 100,000 times
 Materials (Button): Copper alloys, Faceplate: Stainless steel



PBT-025J
Aluminum anodized faceplate

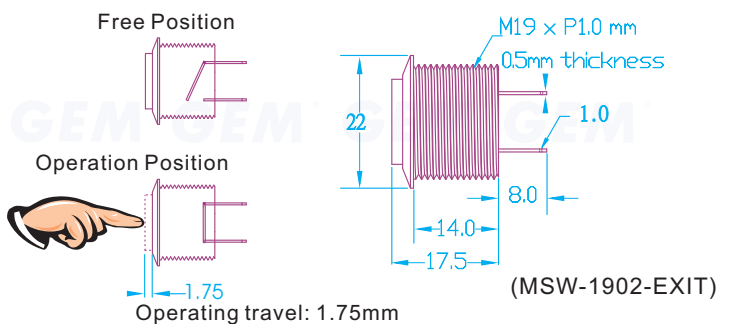
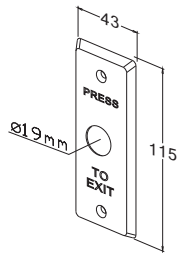

PBT-026J
Aluminum anodized faceplate

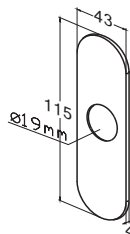

Switch Specifications

Max. Ratings : 5mA@12Vdc
 Type of actuation: Momentary
 Contact arrangement: Single pole single throw (N.O.)
 Operating travel: 1.75mm
 Operating temp. Range: -20~+70C
 Contact resistance: 1kΩ Max.(initial)
 Operating life(5mA 5Vdc) : Over 100,000 times
 Materials: Stainless steel



PBT-200J
Stainless steel faceplate

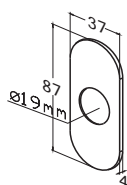

Optional Accessory



SMB-040

The **PBT-010**, **PBT-020**, **PBT-025** can be surface mounting with SMB-040 housing.



GIANNI INDUSTRIES, INC.

No. 13, Zhong Sing Road, Tu-Cheng Industrial Zone,
 Tu-Cheng City, Taipei, Taiwan 23678
 Tel: 886-2 2267 7986 / Fax: 886-2 2267 9876
 E-Mail: info@gianni.com.tw
 Website: gianni.tw
 Copyright 2008 Gianni industries, inc. All rights reserved.
 DM-CA-PBT-Special Ver. F Published on 2008.05.28



The products are manufactured under an ISO 9001 & QC 080000 Certified Quality Management Program environment back its product quality, performance and commitment to customer satisfaction.

Free Manuals Download Website

<http://myh66.com>

<http://usermanuals.us>

<http://www.somanuals.com>

<http://www.4manuals.cc>

<http://www.manual-lib.com>

<http://www.404manual.com>

<http://www.luxmanual.com>

<http://aubethermostatmanual.com>

Golf course search by state

<http://golfingnear.com>

Email search by domain

<http://emailbydomain.com>

Auto manuals search

<http://auto.somanuals.com>

TV manuals search

<http://tv.somanuals.com>