

PBT-900 series push button which is large-sized exit device that is suitable to be installed in a public site where people get in and out frequently. It is easy to push on any position of the durable large-sized stainless steel faceplate for the N.O & N.C switch change over for door egression.

Aluminum box (Chromate treatment)



PBT-900ALU-1



PBT-900ALU-2



PBT-900ALU-3



PBT-900ALU-4

Plastics box



PBT-900-1



PBT-900-2



PBT-900-3



PBT-900-4

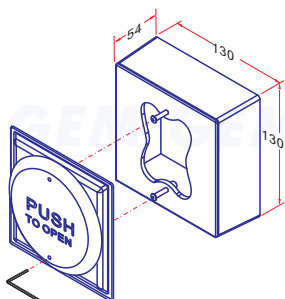

Plastics box

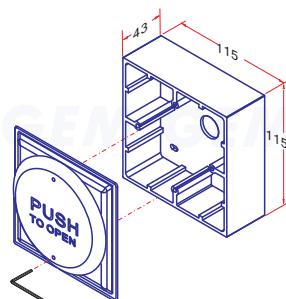

Aluminum box Unit:mm

Connecting diagram as above figure.
N.C. connect with EM-Lock, to cut off power while the large-sized stainless steel faceplate is pushed. It is also allowed that connect N.O. with egress switch of the proximity reader.

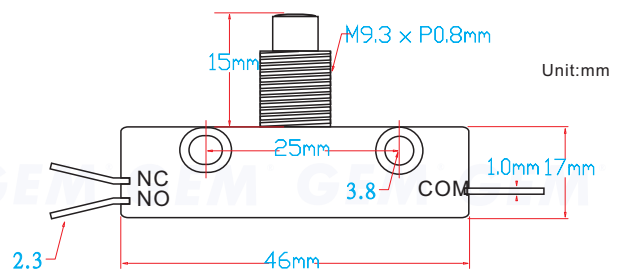
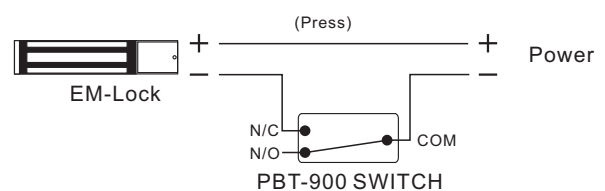
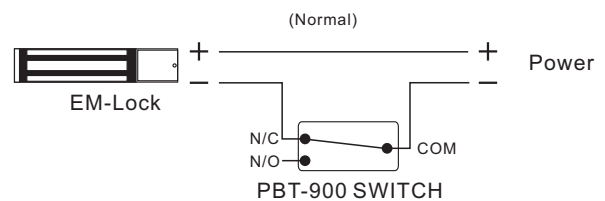
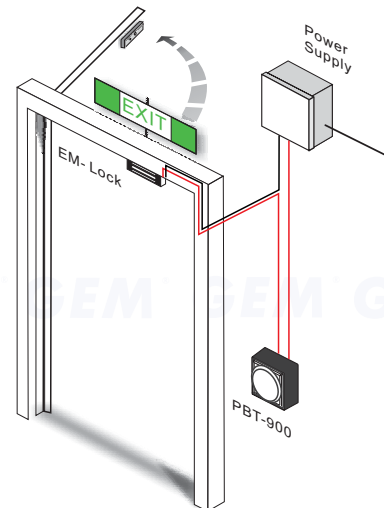

(P-SI-PBT090)

Switch Specifications

Temperature Rating: 105C Std.
Flammability Rating: UL94HB
Max. Ratings : 15A@125 or 250VAC , 2A@48VDC
Type of actuation: Momentary
Contact arrangement: SPDT
Operating travel: 1.27 mm

GIANNI INDUSTRIES, INC.

No. 13, Zhong Sing Road, Tu-Cheng Industrial Zone,
Tu-Cheng City, Taipei, Taiwan 23678
Tel: 886-2 2267 7986 / Fax: 886-2 2267 9876
E-Mail: info@gianni.com.tw
Website: gianni.tw
Copyright 2008 Gianni industries, inc. All rights reserved.
DM-CA-PBT-Surface Ver. E Published on 2008.05.23



The products are manufactured under an ISO 9001 & QC 080000 Certified Quality Management Program environment back its product quality, performance and commitment to customer satisfaction.



PBT-030

Temperature Rating: 105C Std.
 Flammability Rating: UL94HB
 Max. Ratings : 15A@125 or 250VAC , 2A@48VDC
 Type of actuation: Momentary
 Contact arrangement: SPDT
 Operating travel: 1.27 mm

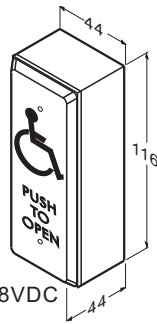

Unit: mm

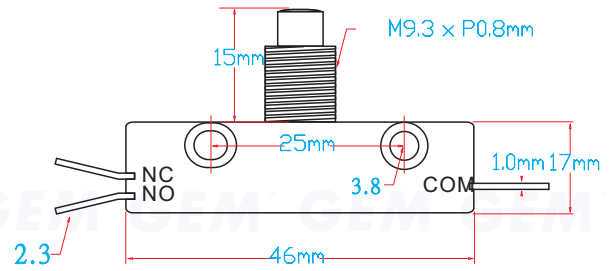

(P-SI-PBT030)



PBT-025JS

Max. Ratings : 5mA@12Vdc
 Type of actuation: Momentary
 Contact arrangement: Single pole single throw (N.O.)
 Operating travel: 1.75mm
 Operating temp. Range: -20~+70C
 Contact resistance: 1kΩ Max.(initial)
 Operating life(5mA 5Vdc) : Over 100,000 times
 Materials: Stainless steel

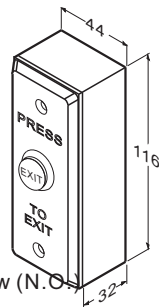

Unit: mm

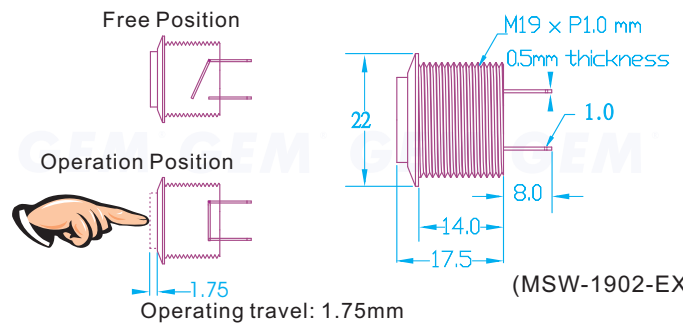

(MSW-1902-EXIT)



PBT-080

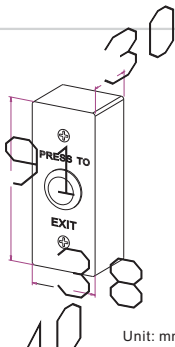

Unit: mm

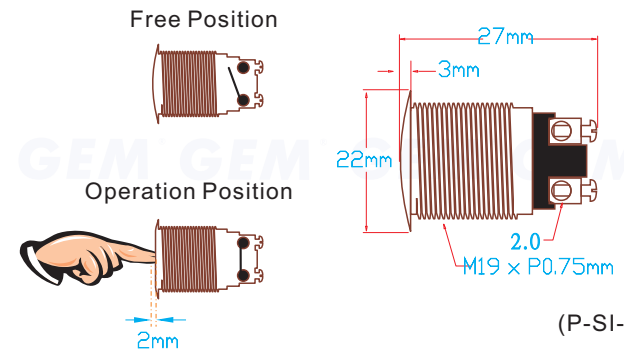

(P-SI-PBT-2)



PBT-090-2

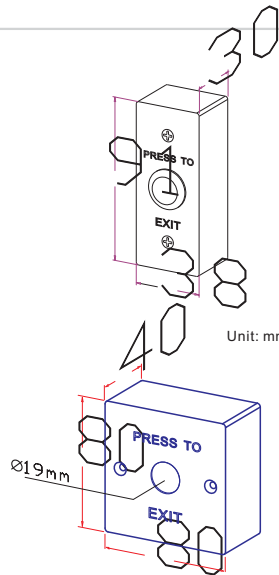

Max. Ratings : 3A@125V AC, 6A@24V DC
 Type of actuation: Momentary
 Contact arrangement: normal open (N.O.)
 Operating travel: 2.0 mm
 Operating temp. Range: -20~+70C
 Contact resistance: 50 mΩ Max.(initial)
 Operating life(Mechanical) : Over 100,000 times
 Materials (Button): Copper alloys, Faceplate: Stainless steel

GIANNI INDUSTRIES, INC.

No. 13, Zhong Sing Road, Tu-Cheng Industrial Zone,
 Tu-Cheng City, Taipei, Taiwan 23678
 Tel: 886-2 2267 7986 / Fax: 886-2 2267 9876
 E-Mail: info@gianni.com.tw
 Website: gianni.tw
 Copyright 2008 Gianni industries, inc. All rights reserved.
 DM-CA-PBT-Surface Ver. E Published on 2008.05.23



The products are manufactured under an ISO 9001 & QC 080000 Certified Quality Management Program environment back its product quality, performance and commitment to customer satisfaction.



PBT-090-4

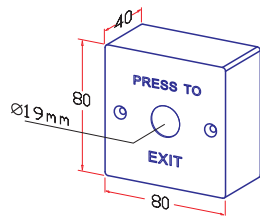

Free Position

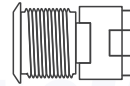

Operation Position

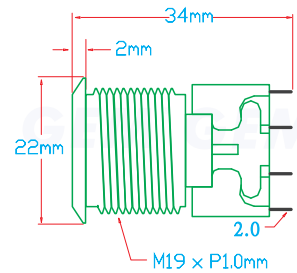
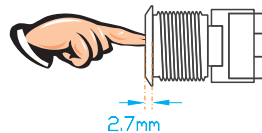

(S-SI-PBT-4-GEM)



PBT-100-4

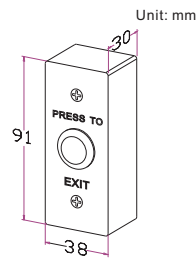

Max. Ratings : 5A@125/250 Vac
 Type of actuation: Momentary
 Contact arrangement: Double pole double throw
 Operating travel: 2.7 mm
 Operating temp. Range: -20~+70C
 Contact resistance: 50 mΩ Max.(initial)
 Operating life(Mechanical) : Over 100,000 times
 Materials: Stainless steel



PBT-160

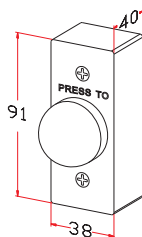

Free Position



Operation Position



Operating travel:
2.7mm

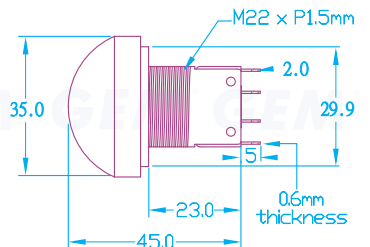

(SWH-160-GE)



PBT-170

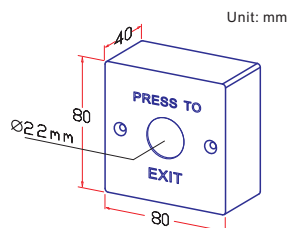

Max. Ratings : 5A@125/250 Vac
 Type of actuation: Momentary
 Contact arrangement: Double pole double throw
 Operating travel: 2.7mm
 Operating temp. Range: -20~+70C
 Contact resistance: 50mΩ Max.(initial)
 Operating life(Mechanical) : Over 100,000 times
 Materials(Button): Zinc alloy, Faceplate: Stainless steel

GIANNI INDUSTRIES, INC.

No. 13, Zhong Sing Road, Tu-Cheng Industrial Zone,
 Tu-Cheng City, Taipei, Taiwan 23678
 Tel: 886-2 2267 7986 / Fax: 886-2 2267 9876
 E-Mail: info@gianni.com.tw
 Website: gianni.tw
 Copyright 2008 Gianni industries, inc. All rights reserved.
 DM-CA-PBT-Surface Ver. E Published on 2008.05.23



The products are manufactured under an ISO 9001 & QC 080000 Certified Quality Management Program environment back its product quality, performance and commitment to customer satisfaction.

Free Manuals Download Website

<http://myh66.com>

<http://usermanuals.us>

<http://www.somanuals.com>

<http://www.4manuals.cc>

<http://www.manual-lib.com>

<http://www.404manual.com>

<http://www.luxmanual.com>

<http://aubethermostatmanual.com>

Golf course search by state

<http://golfingnear.com>

Email search by domain

<http://emailbydomain.com>

Auto manuals search

<http://auto.somanuals.com>

TV manuals search

<http://tv.somanuals.com>